



HAL
open science

Investigation of a massive electricity storage system by means of a geothermal heat transfer process involving Co2 transcritical cycles

Fadhel Ayachi, Thomas Tartière, Nicolas Tauveron, Stéphane Colasson, Denis Nguyen

► To cite this version:

Fadhel Ayachi, Thomas Tartière, Nicolas Tauveron, Stéphane Colasson, Denis Nguyen. Investigation of a massive electricity storage system by means of a geothermal heat transfer process involving Co2 transcritical cycles. 3rd International Seminar on ORC Power Systems, Oct 2015, Bruxelles, Belgium. <hal-04813807>

HAL Id: hal-04813807

<https://hal.science/hal-04813807v1>

Submitted on 2 Dec 2024

HAL is a multi-disciplinary open access archive for the deposit and dissemination of scientific research documents, whether they are published or not. The documents may come from teaching and research institutions in France or abroad, or from public or private research centers.

L'archive ouverte pluridisciplinaire HAL, est destinée au dépôt et à la diffusion de documents scientifiques de niveau recherche, publiés ou non, émanant des établissements d'enseignement et de recherche français ou étrangers, des laboratoires publics ou privés.



HAL Authorization

INVESTIGATION OF A MASSIVE ELECTRICITY STORAGE SYSTEM BY MEANS OF A GEOTHERMAL HEAT TRANSFER PROCESS INVOLVING CO₂ TRANSCRITICAL CYCLES

Fadhel Ayachi¹, Thomas Tartière², Nicolas Tauveron^{1*}, Stéphane Colasson¹, Denis Nguyen³

¹CEA, LITEN – DTBH/SBRT/LS2T, 17 rue des Martyrs, 38054 Grenoble, France
fadhel.ayachi@cea.fr, nicolas.tauveron@cea.fr; stephane.colasson@cea.fr

²Enertime, 1 rue du Moulin des Bruyères, 92400 Courbevoie, France
thomas.tartiere@enertime.com

³BRGM Languedoc-Roussillon, 1039 rue de Pinville, 34000 Montpellier, France
d.nguyen@brgm.fr

* Corresponding Author

ABSTRACT

This work presents a specific application of the Rankine cycle and heat pump technologies: electricity storage. A multi-megawatt thermo-electric energy storage based on thermodynamic cycles is studied as a promising alternative to PSH (Pumped-Storage Hydroelectricity) and CAES (Compressed Air Energy Storage) systems. As a preliminary work, the main objective is to assess the performances of the massive storage technology based on transcritical CO₂ heat pump for charging and transcritical CO₂ Organic Rankine Cycle for discharging, with power output in the 1-10 MWe range.

The general concept of the system is presented, along with its thermodynamic modeling. A parametric analysis is carried out showing that it is possible to reach roundtrip efficiencies up to 53% that are competitive with other technologies. This work also shows the strong dependency between the different parameters of the system, and how an economic optimization will have to take all the subcomponents into account.

1. INTRODUCTION

Organic Rankine Cycles (ORC) have been used in a wide range of applications, including geothermal, biomass or solar power plants, waste heat recovery from industrial processes or combustion engines, ocean thermal energy conversion... and a wide range of power outputs from a few kW to tens of MW. The possibility to use ORC to produce electricity from heat that has been previously stored as a large-scale electricity storage technology remains more confidential but has been the subjects of recent studies [1].

As it is well-known, the massive integration of intermittent renewable energy production generates new challenges for the supervision and regulation of electric grids. The use of flexible but carbon-intensive technologies such as gas turbines has been the main solution in order to ensure the balance between demand and supply, maintaining grid frequency and power quality. However, large-scale electricity storage is a promising alternative with a much lower environmental impact. In addition, it would enable a decentralized access to electricity and lower the dependency on fossil fuels. If storage is still expensive today, it could become increasingly viable as the price of carbon rises.

Several technologies exist or are under development for large-scale energy storage. Pumped Hydro Storage (PHS) is the most common one, accounting for more than 99% of the worldwide bulk storage capacity, representing around 140 GW over 380 locations [2]. When there is an excess of power supply, water is pumped to an upper reservoir, from where it can be discharged to drive a turbine

when power demand is high. Reported roundtrip efficiencies are typically between 70% and 85%. Despite having a long lifetime and being the most cost-effective energy storage technology, these systems have a low energy density and require the construction of large reservoirs, leading to a high environmental impact. In addition, the most suitable locations have already been used in developed countries. Other possibilities would be to include pre-existing dams or the ocean, as in the 30 MW Yanbaru project in Japan [3].

In a Compressed-Air Energy Storage (CAES) system, ambient air is compressed and stored underground. Reported roundtrip efficiencies are around 50%. The capital cost of CAES power plants is competitive with PHS and their power output can reach hundreds of MW. In contrast to PHS, only 2 CAES power plants exist in the world: a 290 MW plant in Huntorf, Germany (1978) [4], and a 110 MW plant in McIntosh, USA (1991) [5]. A much higher efficiency of up to 70% could be achieved by storing the heat of compression before the pressurized air is sent to the cavity [6][7]. This Advanced Adiabatic CAES (AA-CAES) technology is still under development. As for PHS, CAES systems require very specific sites and cannot be installed everywhere.

Thermo-electric energy storage (TEES) is a promising alternative to existing technologies that would allow widespread and large-scale electricity storage. It has a high energy density and is independent from geological or geographical constraints. During periods of excess electricity generation, a vapor compression heat pump consumes electricity and transfers heat between a low-temperature heat source and a higher temperature heat sink. The temperature difference between the heat sink and the heat source can be maintained for several hours, until a power cycle is used to discharge the system and generate electricity during peak consumption hours.

Mercangöz [1] gave references of thermo-electric energy storage studies as old as 1924 and described the general concept of this technology, based on two-way conversion of electricity to and from heat. He stated that the main challenges of TEES are to closely match the heat source and heat sink with the working fluid, and to find an optimum between roundtrip efficiency and capital cost. He analyzed a TEES system with transcritical CO₂, hot water and ice as storage materials. The ABB Corporate Research Center [8][9] described a way to store electricity using two hot water tanks, ice storage and transcritical CO₂ cycles. For similar systems, Morandin [10][11][12] defined a design methodology based on pinch analysis and calculated a 60% maximum roundtrip efficiency for a base case scenario with turbomachinery efficiencies given by manufacturers.

Sensible heat storage with hot water tanks is often considered, since water has high thermal capacity, is very cheap and environmental-friendly. Latent heat storages based on phase change materials (PCMs) have also been widely investigated. The heat sink of the system can be either the ambient or ice. This second option ensures a constant low-pressure for the process that is favorable to turbomachines. A mixture of salt and water can be used to adjust the heat sink temperature between 0°C and -21.2°C (corresponding to the eutectic point with 23.3% of NaCl in the mixture) [10].

Different working fluids can be considered for the thermodynamic cycles. Desrues [13] presented a TEES process based on Argon in forward and backward closed Brayton cycles. Henchoz [14] analyzed the combination of solar thermal energy with TEES based on Ammonia cycles. Kim [15] reviewed current TEES systems and showed that using transcritical CO₂ cycles instead of Argon Brayton cycles leads to a higher roundtrip efficiency even if the required temperature difference between the heat storages is much smaller. He also proposed an isothermal energy storage system based on transcritical CO₂ cycles and liquid piston compressors/expanders.

Carbon dioxide is a natural refrigerant with many advantages. It is a low-cost fluid that is non-toxic, non-flammable, chemically stable, and readily available. In addition, the high fluid density of supercritical CO₂ leads to very compact systems. Many studies have been published to evaluate the potential of supercritical CO₂ as working fluid in power cycles and heat pumps [16][17]. Cayer carried out an analysis [18] and optimization [19] of transcritical CO₂ cycle with a low-temperature

heat source. More recently, the use of CO₂ for multi-megawatt power cycles has reached a commercial step with the American company Echogen [20].

The purpose of this article is to introduce a new type of electro-thermal energy storage process for large scale electric applications, based on transcritical CO₂ cycles and ground heat storage. The conceptual design of the TEES system is addressed here only from a thermodynamic point of view and economic analysis are left for future works.

2. THERMODYNAMIC MODELING

The electro-thermal energy storage system is a high-capacity storage concept that includes:

- i- a hot reservoir made of a set of ground heat exchangers in a low diffusivity rock ;
- ii- a cold reservoir using either ice ($T_{\text{cold}} \leq 0^{\circ}\text{C}$) or a phase-change material ($T_{\text{cold}} > 0^{\circ}\text{C}$);
- iii- two thermodynamic cycles as charging and discharging processes, both using carbon dioxide as working fluid;

The layouts of the thermodynamic cycles are given by Fig. 1 and Fig. 2. Due to the high storage capacity (typically 100 MWh of heat) and the rock low diffusivity, this technology is suitable for long discharge durations (typically >10 hours) and will not offer the same kind of services to the grid than batteries. Therefore, the parameters of the system will vary very slowly with time, and provided that the system is not discharged further than a certain point, can be considered as constant, as a preliminary step. Therefore, the processes are assumed to be at steady state and the system parameters are reported in Table 1. The thermodynamic model is implemented with Engineering Equation Solver (EES) [21].

During off-hours, a transcritical heat pump is used for charging the system: the working fluid leaves the cold reservoir heat exchanger as a saturated vapor at $T_1 = T_{\text{cold}} - \Delta T_{\text{min}}$ and is preheated (1 → 2) through a regenerator, before being adiabatically compressed (2 → 3) with isentropic efficiency $\eta_{\text{s,c}}$. At the compressor outlet, the fluid at $T_3 = (T_{\text{hot}})_{\text{max}} + \Delta T_{\text{min}}$ and supercritical high pressure $P_3 = P_{\text{H}}$ is cooled through the hot reservoir exchangers (3 → 4) and releases heat to the ground, before being subcooled in the regenerator (4 → 5). The liquid is then expanded (5 → 6) to subcritical low pressure P_{L} and is finally evaporated in the cold reservoir exchanger (6 → 1).

Table 1. Input parameters

Storage	
Hot storage max temperature	Variable
Cold storage temperature	Variable
Min temperature difference between heat reservoir and CO ₂ ΔT_{min}	1 K
Charging cycle	
Compressor isentropic efficiency $\eta_{\text{s,c}}$	0.85
Motor efficiency η_{m}	0.98
$(T_4)_{\text{min}}$	30°C
Regenerator pinch	5 K
Discharging cycle	
Net power output \dot{W}_{el}	1 – 10 MW _{el}
Pump isentropic efficiency $\eta_{\text{s,p}}$	0.80
Turbine isentropic efficiency $\eta_{\text{s,t}}$	0.90
Generator efficiency η_{g}	0.98
Regenerator pinch	5 K
Chiller	
Compressor isentropic efficiency	0.85
Motor efficiency	0.98
Condensing temperature	20°C
Evaporating temperature	Same than for discharge cycle

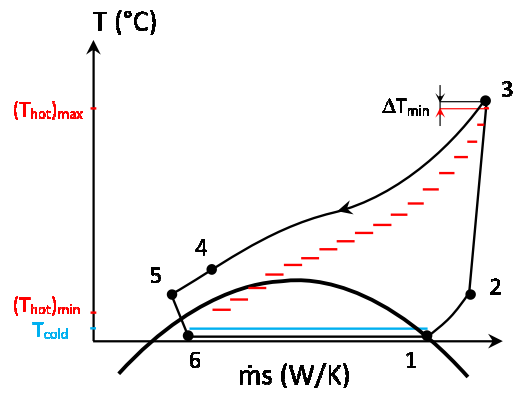
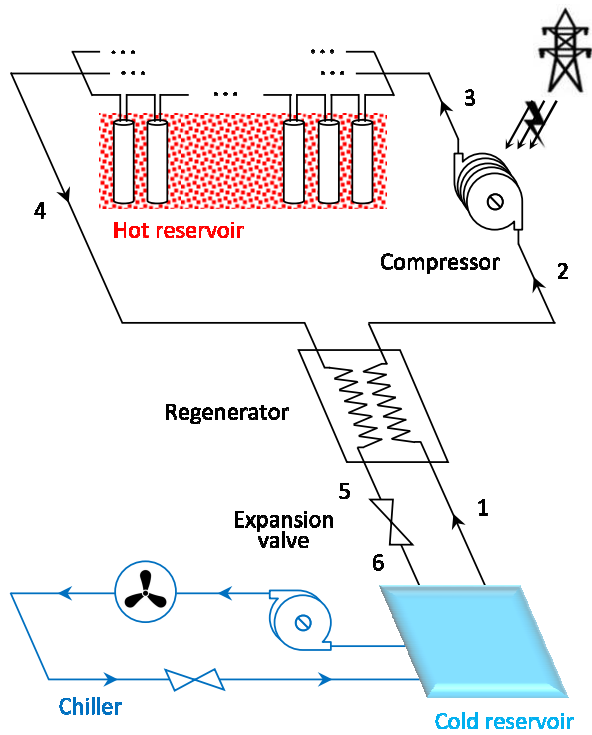

(a)

(b)

Fig. 1. Charging process: a) process layout, b) (T, $\dot{m}s$) diagram.

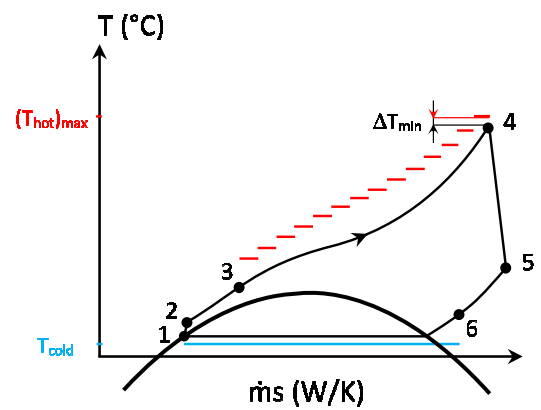
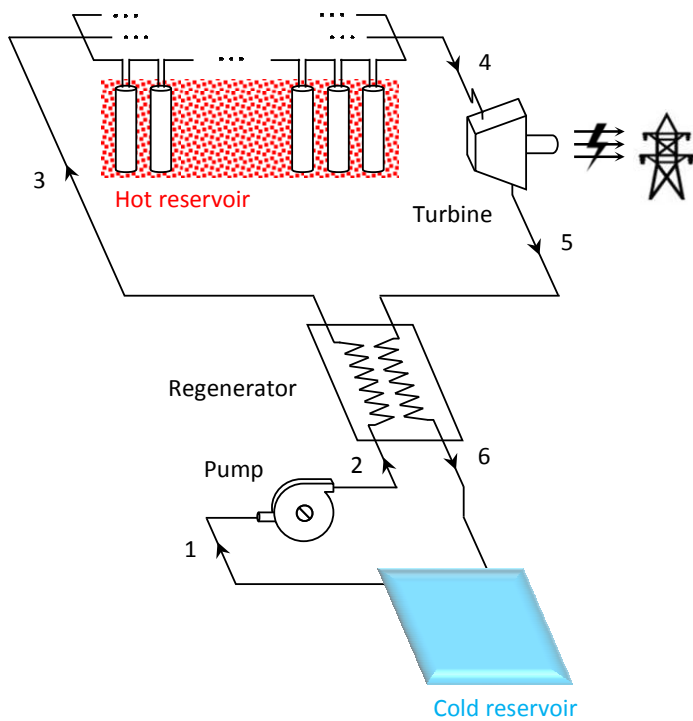

(a)

(b)

Fig. 2. Discharging process: a) process layout, b) (T, $\dot{m}s$) diagram.

High pressures in the range 100-150 bars will require the use of Printed-Circuit Heat Exchangers (PCHE) [22] or more unlikely costly tubular heat exchangers for the regenerator heat exchanger.

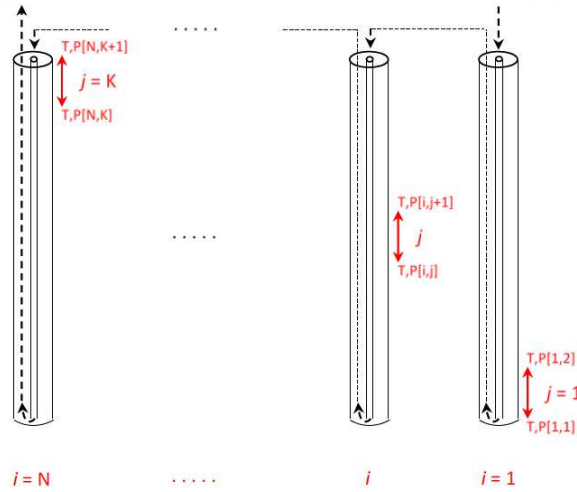

Fig. 3. Principle of the ground heat exchangers

Fig. 3 shows the general principle of the ground heat storage. The fluid at supercritical pressure is injected at the bottom of each column through a central tube and then flows up to an annular exit, transferring heat with the surrounding rock. Several series of ground heat exchangers are installed in parallel in order to reach the required thermal input/output. Detailed simulations of the overall ground heat storage system are being investigated and will enable to estimate the head losses in that component and adjust the cycle parameters. As a preliminary work, pressure losses in the thermodynamic cycles are neglected.

Given the cold storage temperature T_{cold} and ΔT_{min} as input parameters, it is possible to calculate the saturation temperature T_1 and thus the saturation pressure P_L . Similarly, knowing the hot storage temperature, ΔT_{min} and the compressor isentropic efficiency, it is possible to calculate the high pressure P_H . The thermodynamic states of the charging cycle can be obtained from the energy balances of each components:

$$(h_1 - h_2) + (h_4 - h_5) = 0 \quad (1)$$

$$\dot{W}_c + \dot{m}(h_2 - h_3) = 0 \quad (2)$$

$$\dot{Q}_{hot} + \dot{m}(h_3 - h_4) = 0 \quad (3)$$

$$h_5 - h_6 = 0 \quad (4)$$

$$\dot{Q}_{cold} + \dot{m}(h_6 - h_1) = 0 \quad (5)$$

h_i (J/kgK) and \dot{m} (kg/s) being respectively the specific enthalpy at state i and the mass flow rate in the charging cycle. $\dot{W}_c = \dot{m}(h_{3s} - h_2) / \eta_{s,c} > 0$, $\dot{Q}_{hot} < 0$ and $\dot{Q}_{cold} > 0$ are respectively the compressor power, the heat flux transferred to the hot reservoir and the heat flux transferred from the cold reservoir.

Adding equations 1 to 5 leads to the energy balance of the charging cycle:

$$\dot{W}_c + \dot{Q}_{hot} + \dot{Q}_{cold} = 0 \quad (6)$$

During peak-hours, a transcritical Organic Rankine Cycle is used for discharging the system: the working fluid leaves the cold reservoir heat exchanger at saturation $T_1' = T_{cold} + \Delta T_{min}$ and is pumped ($1 \rightarrow 2$) with isentropic efficiency $\eta_{s,p}$. At the pump outlet, the fluid at supercritical high pressure $P_2' = P_H'$ is preheated in the regenerator ($2 \rightarrow 3$), then heated in the hot reservoir exchanger ($3 \rightarrow 4$) where it recovers heat from the ground and reaches $T_4' = (T_{hot})_{max} - \Delta T_{min}$. The fluid is then adiabatically expanded ($4 \rightarrow 5$) with isentropic efficiency $\eta_{s,t}$ to the subcritical pressure P_L' , producing mechanical power. Finally, the fluid is cooled in the regenerator ($5 \rightarrow 6$) before being condensed through the cold reservoir exchanger ($6 \rightarrow 1$).

The reservoir temperatures T_{cold} and $(T_{hot})_{max}$ and the hot pressure $P_H' \approx P_H$ being known, the thermodynamic states can be obtained from the energy balances of each component:

$$\dot{W}_p' + \dot{m}'(h_1' - h_2') = 0 \quad (7)$$

$$(h_2' - h_3') + (h_5' - h_6') = 0 \quad (8)$$

$$\dot{Q}_{hot}' + \dot{m}'(h_3' - h_4') = 0 \quad (9)$$

$$\dot{W}_t' + \dot{m}'(h_4' - h_5') = 0 \quad (10)$$

$$\dot{Q}_{cold}' + \dot{m}'(h_6' - h_1') = 0 \quad (11)$$

h_i' (J/kgK) and \dot{m}' (kg/s) being respectively the specific enthalpy at state i and the mass flow rate of the discharging cycle. $\dot{W}_p'(W) = \dot{m}'(h_{2s}' - h_1') / \eta_{s,p} > 0$, $\dot{W}_t'(W) = \dot{m}'(h_{5s}' - h_4') \eta_{s,t} < 0$, $\dot{Q}_{hot}'(W) > 0$ and $\dot{Q}_{cold}'(W) < 0$ are respectively the pump power, the turbine power, the heat flux transferred from the hot reservoir and the heat flux transferred to the cold reservoir.

Adding equations 7 to 11 gives the energy balance of the discharge cycle:

$$\dot{W}_p' + \dot{Q}_{hot}' + \dot{W}_t' + \dot{Q}_{cold}' = 0 \quad (12)$$

As an example, the Temperature-Entropy diagram of the charging and discharging cycles, for hot storage at 130°C and cold storage at 0°C, are given in Fig. 4.

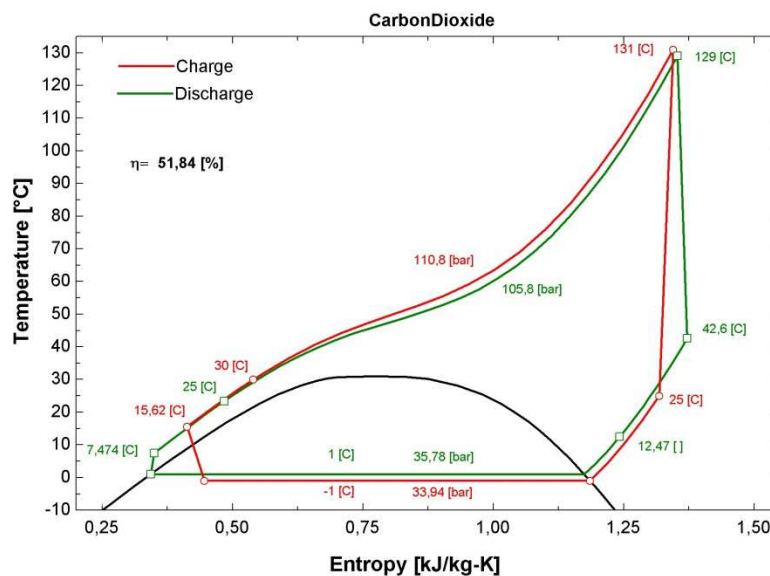

Fig. 4. T-S diagram for hot storage at 130°C and cold storage at 0°C ($\Delta T_{min} = 1K$).

The net power output of the discharge cycle $\dot{W}'_{el} = \eta_g \cdot \dot{W}'_t - \dot{W}'_p$ is defined as an input parameter, in the range 1-10 MWe_l. The thermal energy stored in the ground heat exchangers is $\dot{Q}'_{hot} \cdot t_{discharge} = -\dot{Q}'_{hot} \cdot t_{charge}$. As a first step, we assume similar charging and discharging time so $\dot{Q}'_{hot} \cong -\dot{Q}'_{hot}$. This gives the mass flow rates \dot{m} and \dot{m}' and then the net power input of the charging cycle $\dot{W}_{el} = \dot{W}_c / \eta_m$. Having a different charge duration would only change the mass flow rate of the charging heat pump cycle, and therefore its power input, but does not affect the thermodynamic analysis.

Furthermore, by adding equations 6 and 12 and using $\dot{Q}'_{hot} = -\dot{Q}'_{hot}$, it follows that:

$$\dot{W}_c + \dot{Q}_{cold} + \dot{W}'_p + \dot{W}'_t + \dot{Q}'_{cold} = 0 \quad (13)$$

Based on Equation 13, we can define the thermal asymmetry of the system such as:

$$\delta\dot{Q}_{cold} = \dot{Q}_{cold} + \dot{Q}'_{cold} = -(\dot{W}_c + \dot{W}'_p + \dot{W}'_t) < 0 \quad (14)$$

The charging and discharging cycles are not perfectly reversible. Even if the discharging cycle can consume the same amount of heat than provided by the charging cycle ($\dot{Q}'_{hot} = -\dot{Q}'_{hot}$), the amount of cold produced by the heat pump cycle is smaller than the amount needed during the discharge. Therefore, the thermal asymmetry of the system represents the amount of additional cooling that is needed to discharge the system and that should be provided by an auxiliary CO₂ chiller working in parallel with the charging cycle (Fig. 1a).

A thermodynamic model of a single-stage chiller, with parameters given in Table 1, is developed using EES in order to calculate this additional electrical consumption $\dot{W}'_{el}(W)$, expressed by equation 15.

$$\dot{W}'_{el} = \frac{-\delta\dot{Q}_{cold}}{COP} \quad (15)$$

Finally, assuming similar charging and discharging durations, the overall roundtrip efficiency of the system can be defined as:

$$\eta_{sys} = \frac{\dot{W}'_{el}}{\dot{W}_{el} + \dot{W}'_{el}} \quad (16)$$

This steady-state analysis provided a limited but useful first analysis of the system, in order to assess the main characteristics of each component and the dependency between the charging and discharging cycles. A time-dependent model of the system is under development but requires a detailed simulation of the diffusion through the ground heat exchangers, and a thorough understanding of the convection heat transfer coefficient between the supercritical CO₂ and the rock. These two topics are being investigated and will be detailed in future works.

3. PARAMETRIC ANALYSIS

Based on this preliminary thermodynamic modeling, it is possible to carry out a parameter analysis of the system. Figure 5 shows the efficiency of the system with respect to the temperature of the heat storages. As we can see, it is possible to reach roundtrip efficiencies up to 53% with high storage temperatures and 1 K-temperature difference between the charging and discharging cycle (ΔT_{min}).

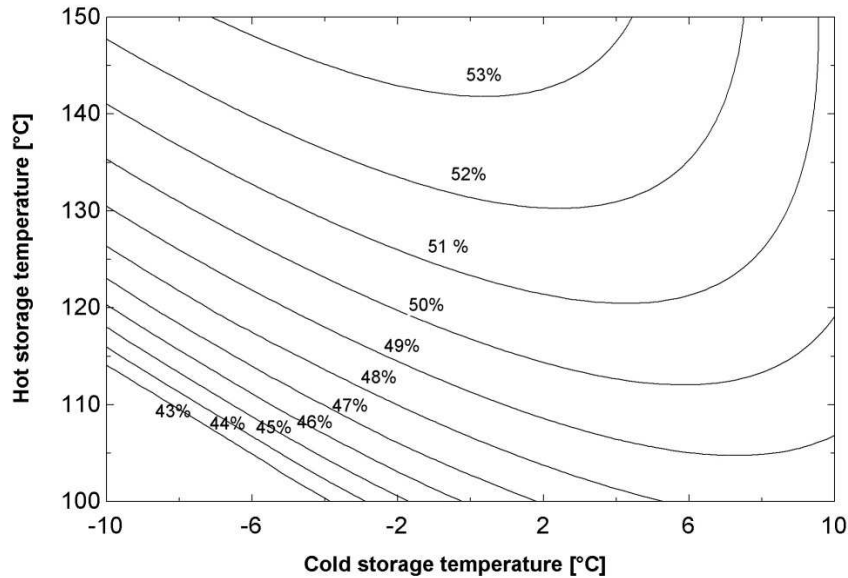

Fig. 5. Overall efficiency of the storage system with respect to the design storage temperatures ($\Delta T_{\min} = 1\text{K}$).

The choice of temperatures for the hot and cold storages will not only impact the overall electrical efficiency but also the size of the storages and the initial investment cost. For example, Fig. 6 gives the roundtrip efficiency as a function of the cold storage temperature for a hot storage at 130°C. In that case, it is possible to reach a maximum overall efficiency of 51.8% for a cold storage at 2°C. This is mainly due to the fact that the heat pump COP increases significantly when the cold storage temperature is increased, thus decreasing the electricity consumption of the system. In addition, this also reduces the pressure ratio in the two thermodynamic cycles and therefore simplifies the design of the turbomachines.

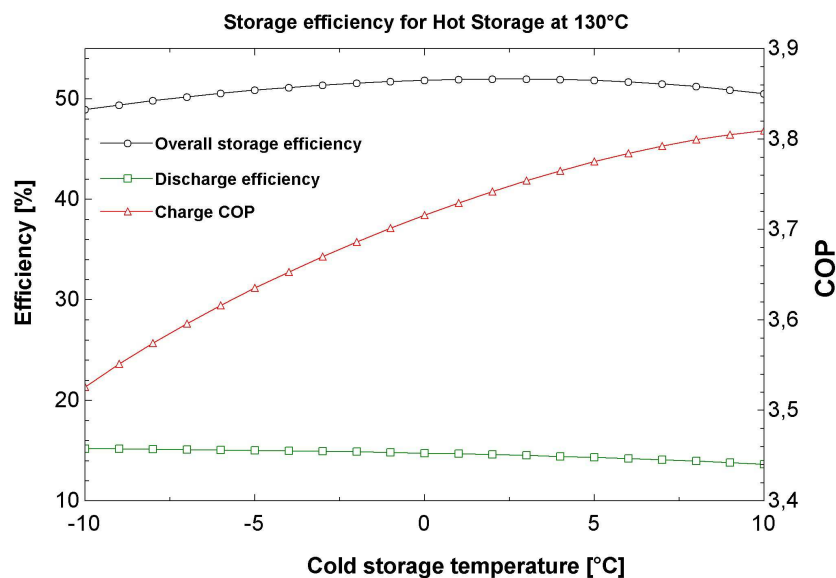

Fig. 6. Storage efficiency as a function of cold storage temperature ($(T_{\text{hot}})_{\max} = 130^{\circ}\text{C}$, $\Delta T_{\min} = 1\text{K}$).

Figure 7 shows the thermal asymmetry of the system, as defined by Equation 13, as a function of the cold storage temperature, for a hot storage at 130°C. We can see that the increase in storage efficiency shown in Figure 6 when changing the cold storage temperature from -10°C to 0°C is also due to a smaller asymmetry between the charging and discharging cycles. In addition, the performance of the chiller that provides this additional cooling is improved with higher cold storage temperatures.

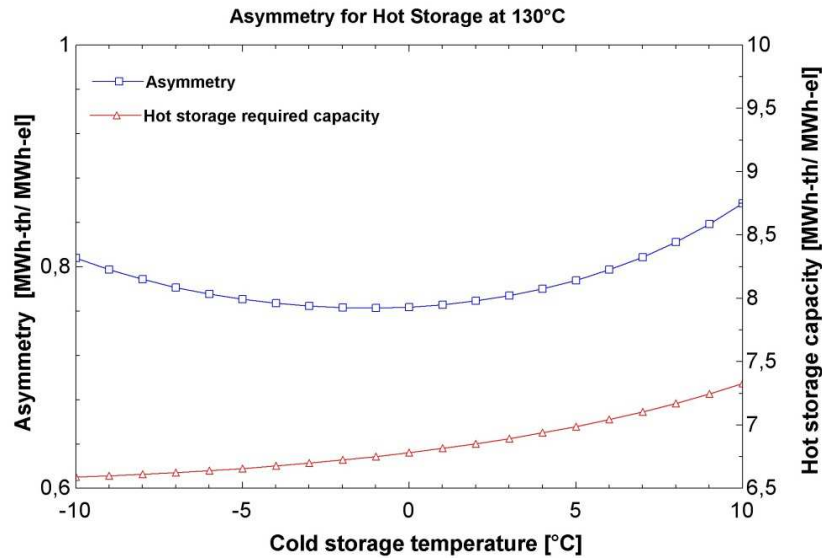

Fig. 7. Asymmetry as a function of cold storage temperature ($(T_{\text{hot}})_{\text{max}} = 130^{\circ}\text{C}$, $\Delta T_{\text{min}} = 1\text{K}$).

However, decreasing the temperature difference between the two storages reduces the power cycle efficiency. This means that the discharging cycle has to consume more heat in order to produce the same electrical power output. Therefore, the hot storage has to be bigger, leading to an increase of about 11% between the cases of cold storage at -10°C and 10°C . In addition, for a given hot storage temperature, the high pressure of the system increases with warmer cold storage temperatures, as shown in figure 8.

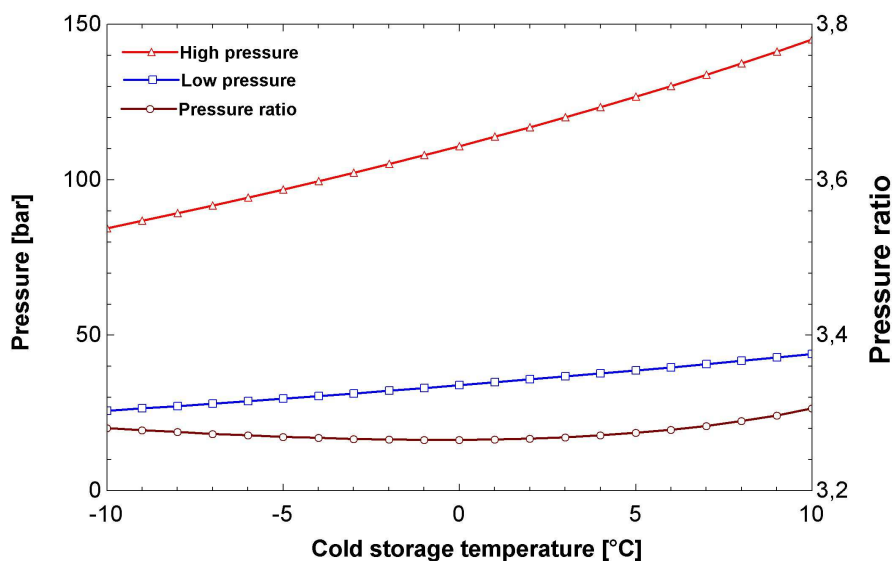

Fig. 8. Pressures of the system as a function of cold storage temperature ($(T_{\text{hot}})_{\text{max}} = 130^{\circ}\text{C}$, $\Delta T_{\text{min}} = 1\text{K}$).

As we can see, the system optimization has to take all these elements into account in order to find a trade-off between efficiency and investment cost. Further works will take turbomachinery and heat storage designs into account in the process design, enabling a cost optimization of the storage system.

4. CONCLUSION

This work carries out the analysis of a novel system storing electricity in the form of ground heat and ice, using transcritical Heat Pump and transcritical ORC cycles for the charging and discharging processes. A thermodynamic modeling is presented and a parametric analysis shows roundtrip efficiencies of up to 53% that are competitive with other technologies. Further work through the SELECO₂ project will include turbomachinery and heat storage designs in order to have a more detailed overview of the system and of the dependency between the charging and the discharging processes which can represent large off-design conditions. Furthermore transient simulations of the complete charging/discharging cycle will be performed and confirm (or not) the efficiency value and the general interest of the device.

REFERENCES

- [1] Mercangöz M, Hemrle J, Kaufmann L, Z'Graggen A, Ohler C. Electrothermal energy storage with transcritical CO₂ cycles. *Energy* 2012; 45: 407–415.
- [2] ENEA Consulting, Facts & Figures : Le Stockage d'Énergie. 2012; Available at: <<http://www.enea-consulting.com/wp-content/uploads/ENEA-Consulting-Le-Stockage-dEnergie.pdf> > [accessed 22.01.2015].
- [3] Fujihara T, Imano H, Oshima K. Development of Pump Turbine for Seawater Pumped-Storage Power plant. *Hitachi Review* 1998 : 47 (5): 199-202.
- [4] Crotogino F, Mohmeyer K-U, and Scharf R. Huntorf CAES: More than 20 Years of Successful Operation. Proc of SMRI Spring Meeting, Orlando, Florida, USA, 15-18 April 2001.
- [5] PowerSouth Energy Cooperative, CAES McIntosh Alabama. Available at: <http://www.powersouth.com/mcintosh_power_plant/compressed_air_energy> [accessed 23.01.2015]
- [6] Chris Bullough, Christoph Gatzen, Christoph Jakiel, Martin Koller, Andreas Nowi, Stefan Zunft, Advanced adiabatic compressed air energy storage for the integration of wind energy, in: Proceedings of the European Wind Energy Conference, London UK, 2004.
- [7] Grazzini G, Milazzo A. Thermodynamic analysis of CAES/TES systems for renewable energy plants. *Renewable Energy* 2008;32:1998-2006.
- [8] Mercangoez M, Hemrle J, Kaufmann L. Thermoelectric energy storage system having two thermal baths and method for storing thermoelectric energy. Patent EP2241737 (A1) [Internet]. 20.10.2010. Available at: www.google.com/patents/EP2241737A1 [accessed 22.05.15].
- [9] Ohler C, Mercangoez M. Thermoelectric energy storage system and method for storing thermoelectric energy. Patent EP2182179 (A1) [Internet]. 05.05.2010. Available at: www.ipo.gov.uk/p-ipsum/case/PublicationNumber/EP2182179 [accessed 22.01.15].
- [10] Morandin M, Maréchal F, Mercangöz M, Buchter F. Conceptual design of a thermo-electrical energy storage system based on heat integration of thermodynamic cycles - Part A: Methodology and base case. *Energy* 2012;45:375e85.
- [11] Morandin M, Maréchal F, Mercangöz M, Buchter F. Conceptual design of a thermo-electrical energy storage system based on heat integration of thermodynamic cycles - Part B: Alternative system configurations. *Energy* 2012;45:386-96.
- [12] Morandin M, Mercangöz M, Hemrle J, Maréchal F, Favrat D. Thermoeconomic design optimization of a thermo-electric energy storage system based on transcritical CO₂ cycles. *Energy* 2013; 58: 571–587.
- [13] Desrues T, Ruer J, Marty P, Fourmigué JF. A thermal energy storage process for large scale electric applications. *Applied Thermal Engineering* 2010;30(5):425-32
- [14] Henchoz S, Buchter F, Favrat D, Morandin M, Mercangoez M. Thermoeconomic analysis of a solar enhanced energy storage concept based on thermodynamic cycles. *Energy* 2012;45(1):358e65.
- [15] Kim YM, Shin DG, Lee SY, Favrat D. Isothermal transcritical CO₂ cycles with TES (thermal energy storage) for electricity storage. *Energy* 2013; 49: 484–501.

- [16] Kim YM, Kim CG, Favrat D. Transcritical or supercritical CO₂ cycles using both low- and high-temperature heat sources. *Energy* 2012; 43: 402–415.
- [17] Li M, Wang J, Li S, Xurong Wang, He W, Dai Y. Thermo-economic analysis and comparison of a CO₂ transcritical power cycle and an organic Rankine cycle. *Geothermics* 2014; 50: 101–111.
- [18] Cayer E, Galanis N, Désilets M, Nesreddine H, Roy P. Analysis of a carbon dioxide transcritical power cycle using a low temperature source. *Applied Energy* 2009;86:1055–63.
- [19] Cayer E, Galanis N, Nesreddine H. Parametric study and optimization of a transcritical power cycle using a low temperature source. *Applied Energy* 2010;87:1349-1357
- [20] Held T., Initial Test Results of a Megawatt-class Supercritical CO₂ heat engine. The 4th International Symposium – Supercritical CO₂ Power Cycles; 2014 Sept 9-10; Pittsburgh, USA.
- [21] S.A. Klein, Engineering Equation Solver. F-Chart Software, Middleton, WI, 2010.
- [22] Le Pierres R., Southall D., Osborne S. Impact of Mechanical Design Issues on Printed Circuit Heat Exchangers, in: *Proceedings of SCO₂ Power Cycle Symposium*, Boulder, 2011

ACKNOWLEDGEMENT

The authors acknowledge the support of the French Agence Nationale de la Recherche (ANR), under grant ANR-13-SEED-0004 (project SELECO₂).