



HAL
open science

Optimization of the shunt resistance of Cu(In,Ga)Se₂ cells for indoor applications

Maya El Khoury, Matthieu Moret, Antoine Tiberj, Wilfried Desrat

► To cite this version:

Maya El Khoury, Matthieu Moret, Antoine Tiberj, Wilfried Desrat. Optimization of the shunt resistance of Cu(In,Ga)Se₂ cells for indoor applications. 13èmes Journées Nationales du Photovoltaïque (JNPV 2023), Dec 2023, Dourdan, France. . <hal-04810791>

HAL Id: hal-04810791

<https://hal.science/hal-04810791v1>

Submitted on 29 Nov 2024

HAL is a multi-disciplinary open access archive for the deposit and dissemination of scientific research documents, whether they are published or not. The documents may come from teaching and research institutions in France or abroad, or from public or private research centers.

L'archive ouverte pluridisciplinaire HAL, est destinée au dépôt et à la diffusion de documents scientifiques de niveau recherche, publiés ou non, émanant des établissements d'enseignement et de recherche français ou étrangers, des laboratoires publics ou privés.



HAL Authorization

M. El Khoury^{1,2}, M. Moret¹, A. Tiberj^{1,2}, W. Desrat^{1,2}

¹ Laboratoire Charles Coulomb (L2C), Université de Montpellier, CNRS, Montpellier, France

² IUT de Nîmes, Université de Montpellier, Nîmes, France

Abstract

With the rise of Internet of Things (IoT), a sustainable and efficient power source for electronic devices, such as indoor photovoltaics, is essential [1]. Copper poor and gallium rich CIGS photovoltaic cells, marked by a high parallel resistance, hold promise for these applications, yet they have not received thorough exploration in the past [2].

In this poster we present an extended analysis of the I-V electrical characteristics of several CIGS solar cells, with different gallium and copper contents, measured with a white LED from 45000 lx down to extremely low illumination (~50 lx). Notably, regardless of the gallium content, copper poor cells with a CGI between 0.45 and 0.5 exhibited the highest shunt resistance. This resulted in a remarkable increase of the P_{max} by a factor of one thousand when compared to conventional copper-rich CIGS solar cells when tested under low light conditions (50 lx).

Structure of a CIGS cell

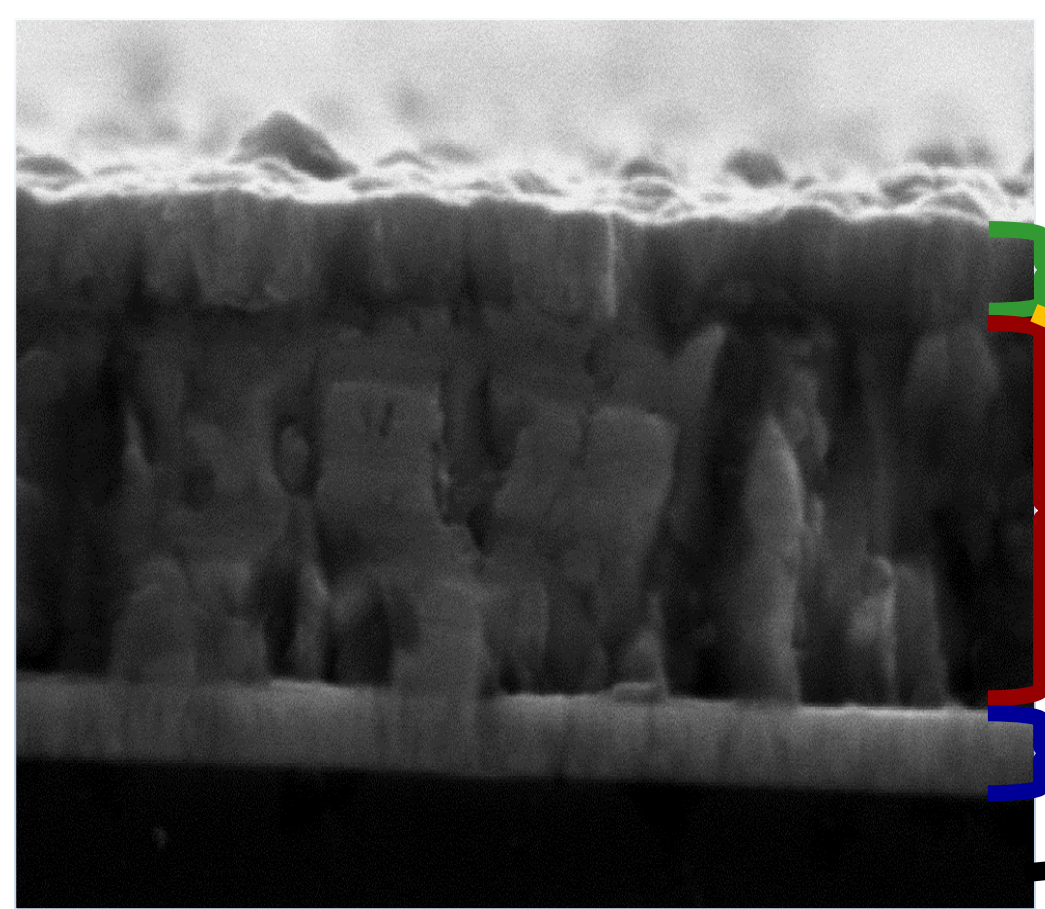

ZnO/ZnO:Al (n)
CdS (n)
CIGS (p)
Mo
SLG

$$CGI = \frac{Cu}{In+Ga} = 0.93$$

$$GGI = \frac{Ga}{In+Ga} = 0.28$$

This work focuses on optimizing only the CIGS absorber layer

Cu(In,Ga)Se₂ cell measured with different irradiance levels: Outdoor vs indoor

Standard cell I-V measurements

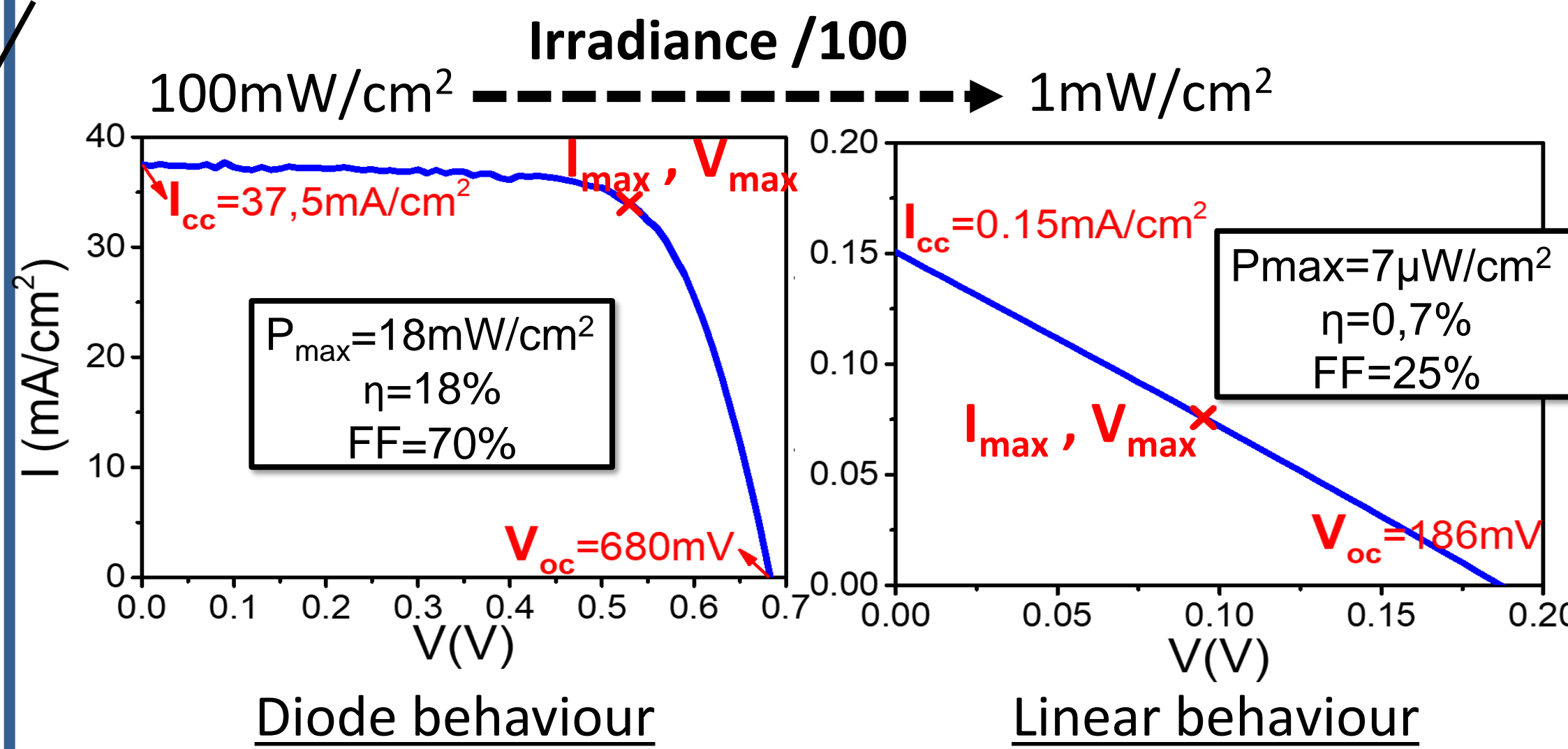

At low irradiance levels, CIGS cells optimized for traditional use (outdoor) have linear behavior. This is due to their low shunt resistance (R_p) that presents an undesired pathway for the current to bypass the diode.

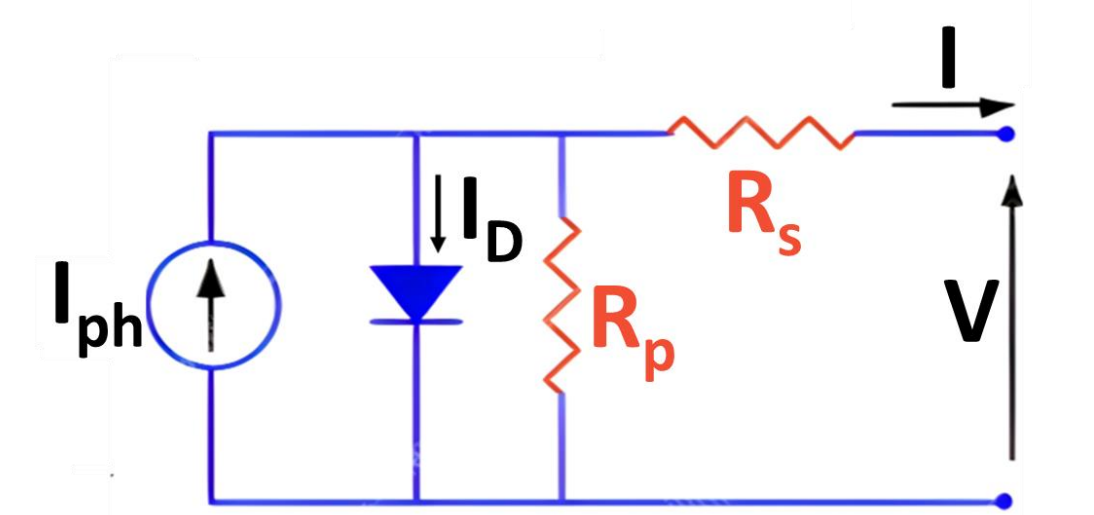

Copper poor and Gallium rich CIGS for indoor applications

Virtuani et al. demonstrated that **copper-deficient CIGS** cells marked by a high parallel resistance perform better under low irradiance conditions (dimmed solar spectrum). We want to evaluate these cells using a **white LED** (indoor conditions).

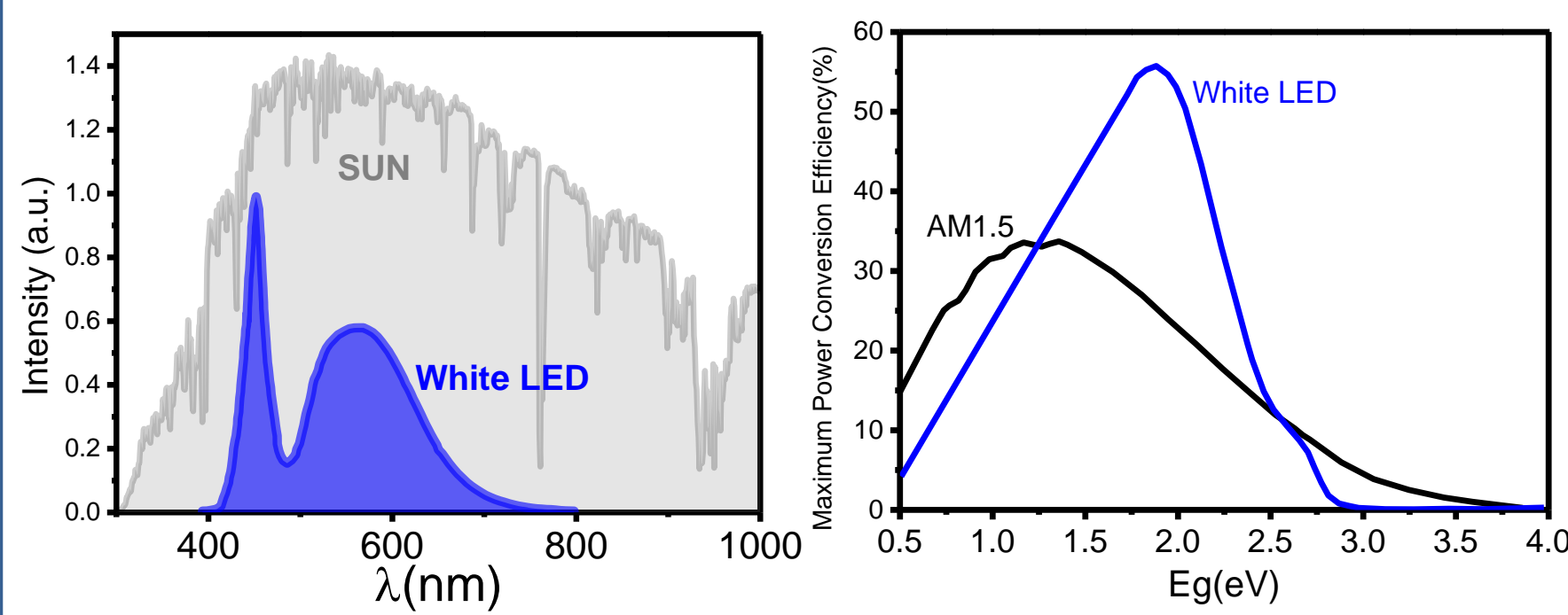

The spectral differences between the sun and the LED implies the need for a wider band gap ~ 1,8 eV for maximum absorption. That is why we extended our analysis to **Gallium rich** (wider band gap) and **copper poor** compositions.

Composition of the samples elaborated in my thesis at L2C

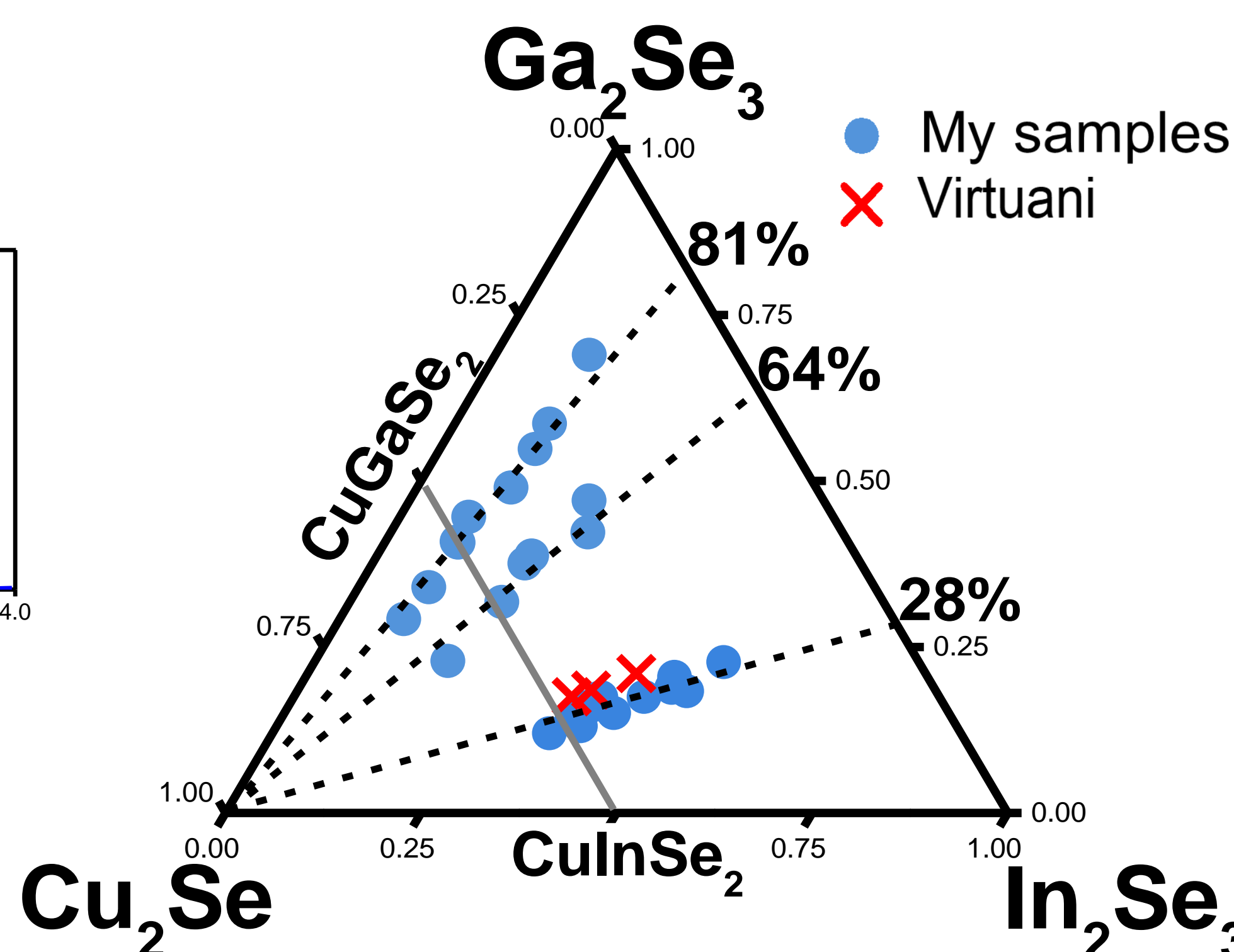

Effect of the Gallium content

EQE measurements:

The band gap was optimized from 1,15 eV (28%, CGI=0,94) to 1,57 eV (81%, CGI=0,49) for Gallium rich and copper poor CIGS cells.

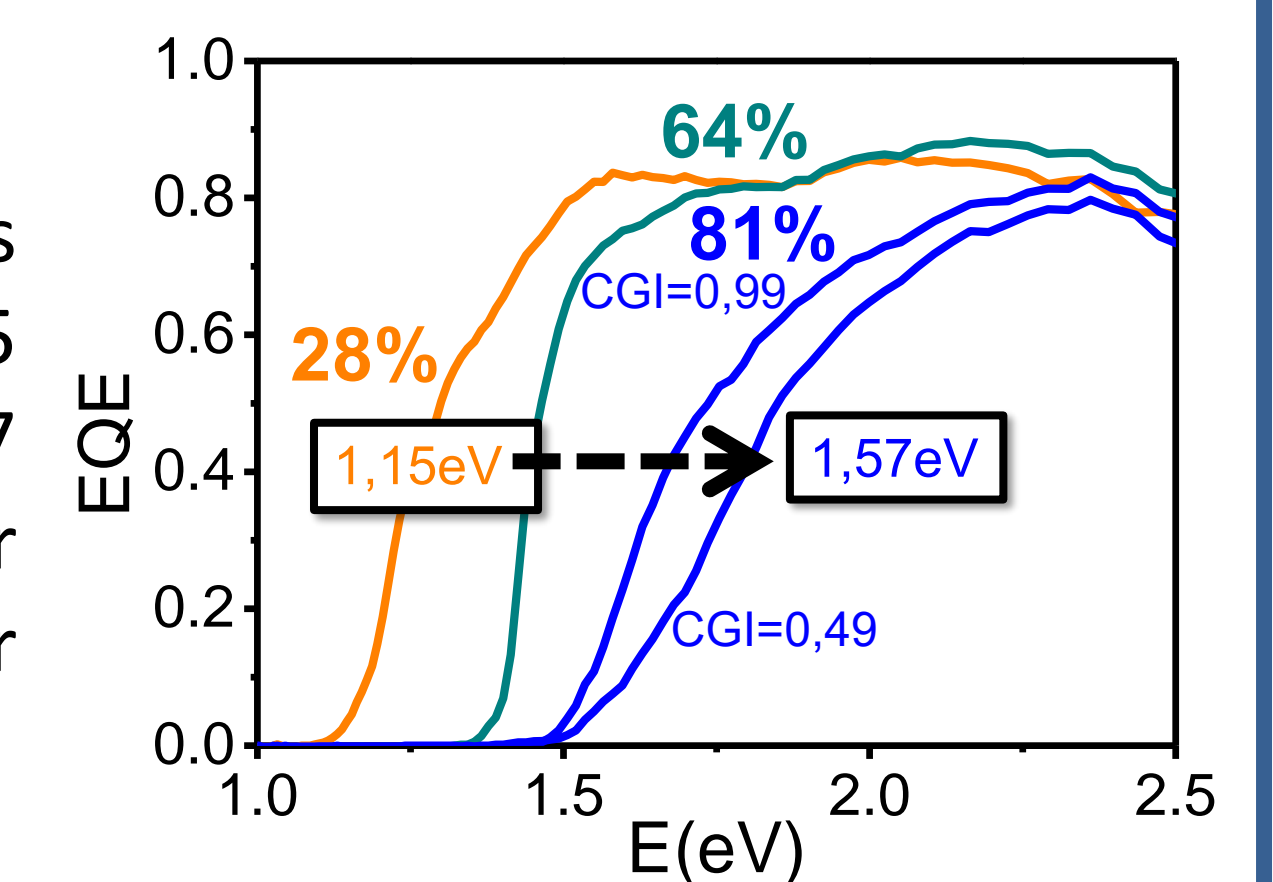

I_{cc} Measured at 200lx (LED) Vs dimmed solar spectrum

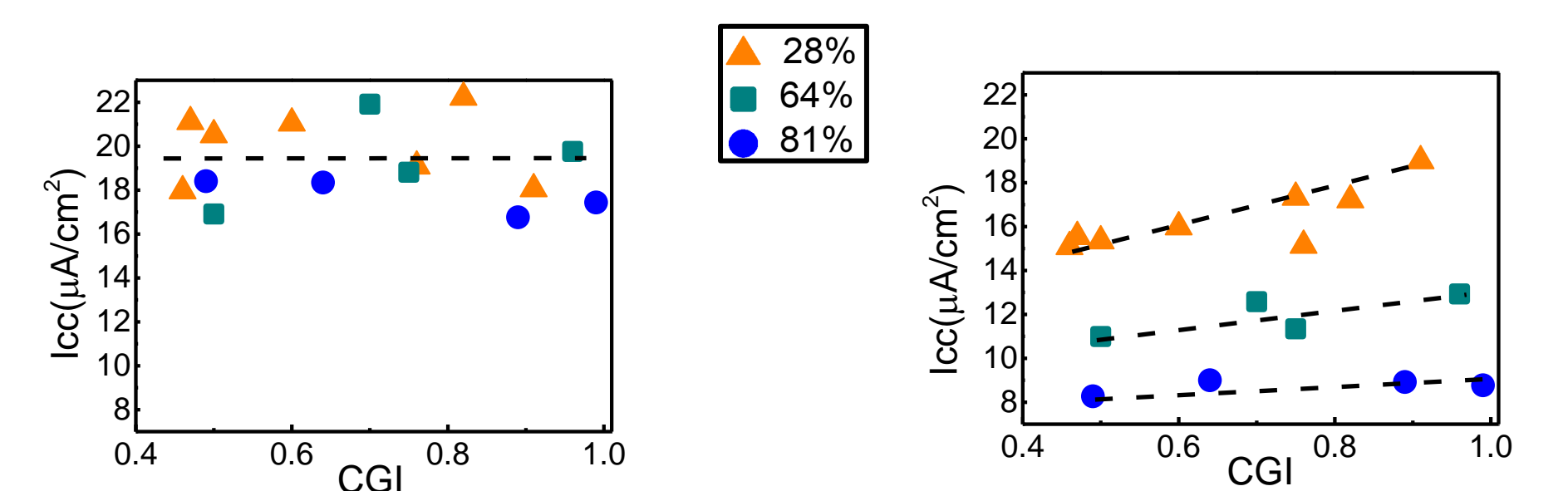

The increase of the bandgap keeps a constant I_{cc} in the case of the LED while a reduction is observed with the sun.

Effect of the copper content on the shunt resistance and the performance of CIGS cells

The Current-voltage characteristics are measured with a white LED over 3 orders of illuminance.

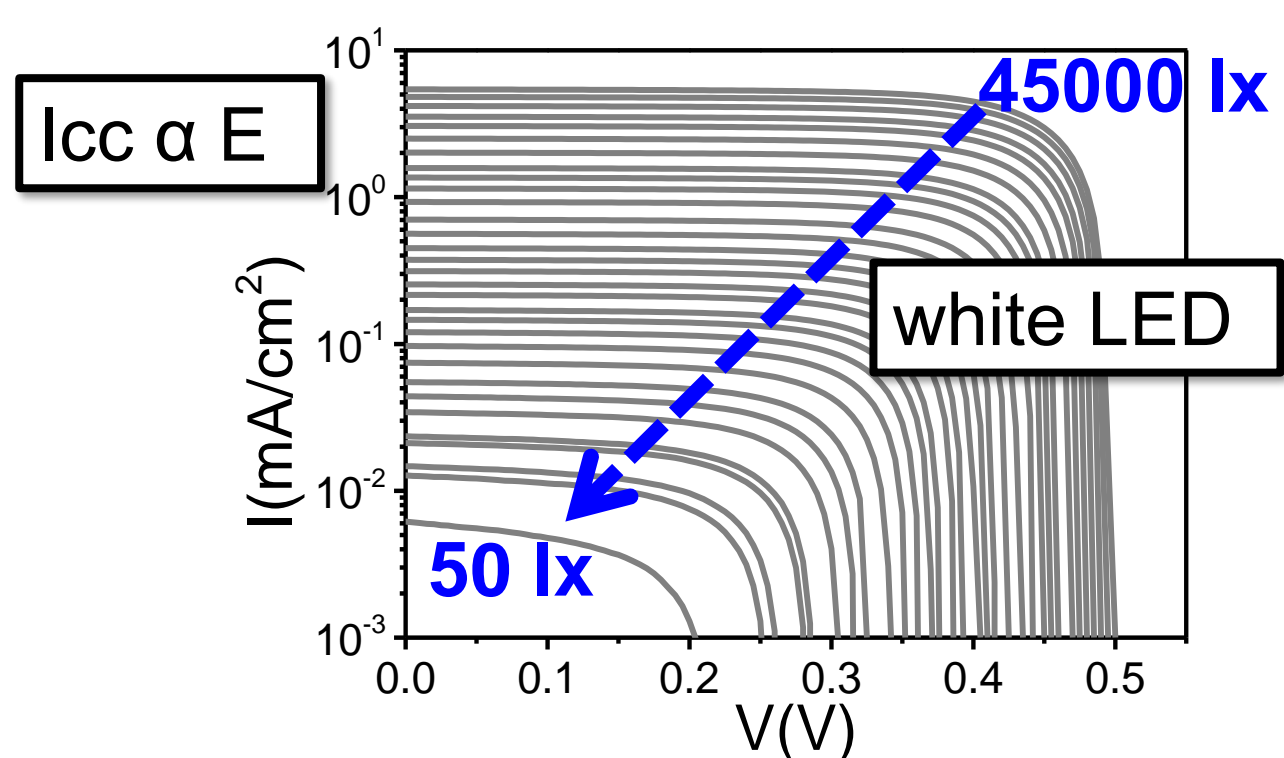

An improvement of the electrical parameter has resulted in enhancing the P_{max} by a factor 1000 in indoor conditions.

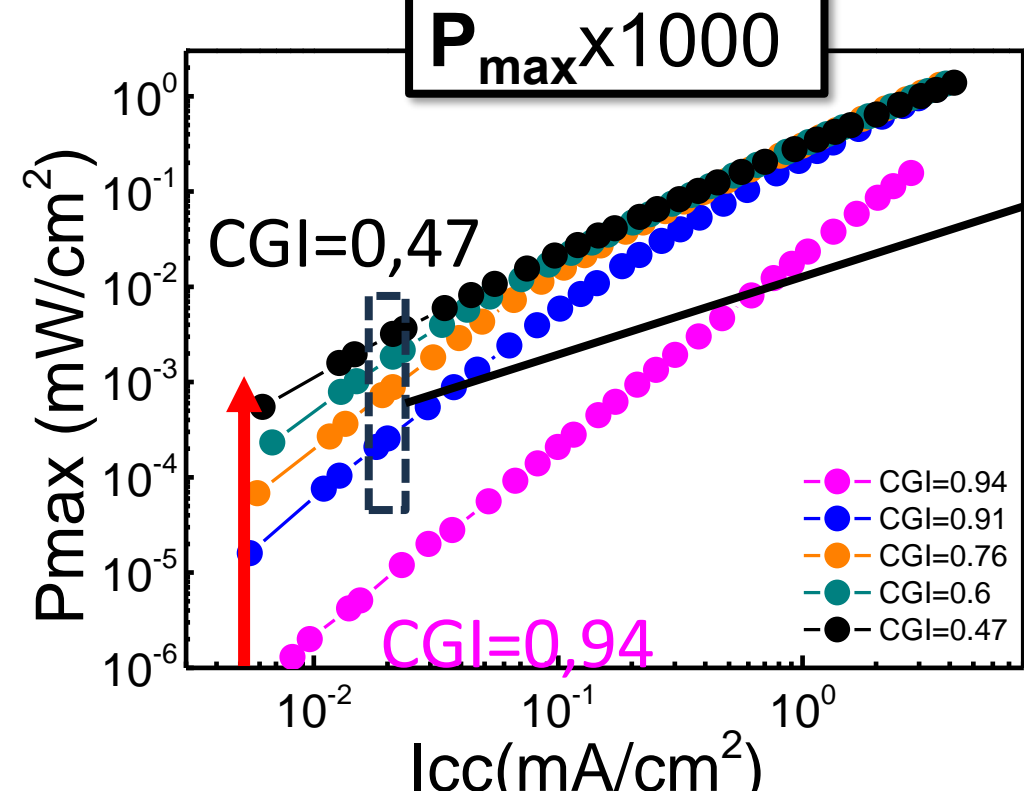

Comparing the I-V curve at **200 lux**, the copper-deficient cell exhibits diode-like behavior, leading to improved performance.

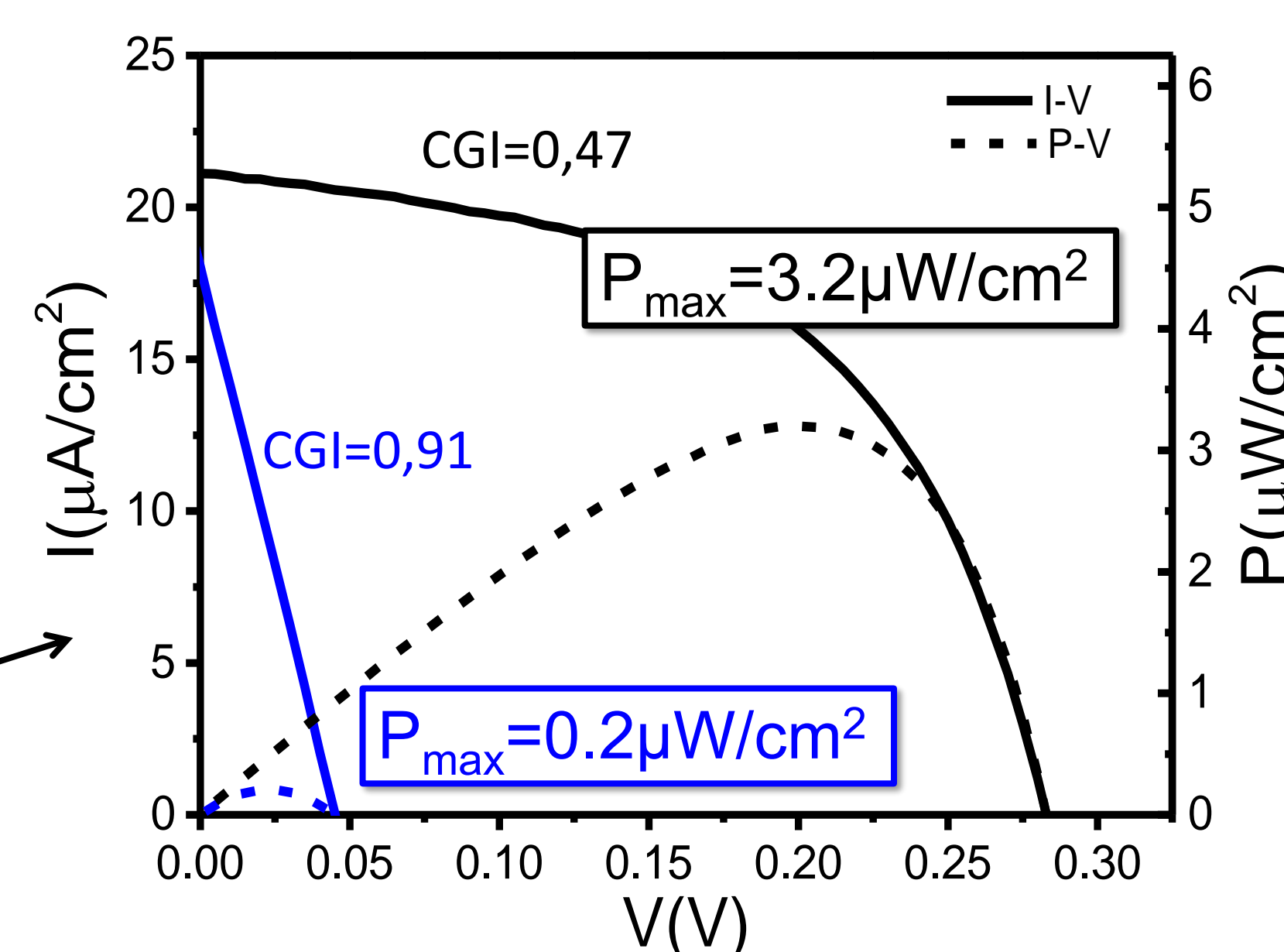

Effectively, the copper poor cells that showed the best performances at low light are those with the **highest shunt resistance**.

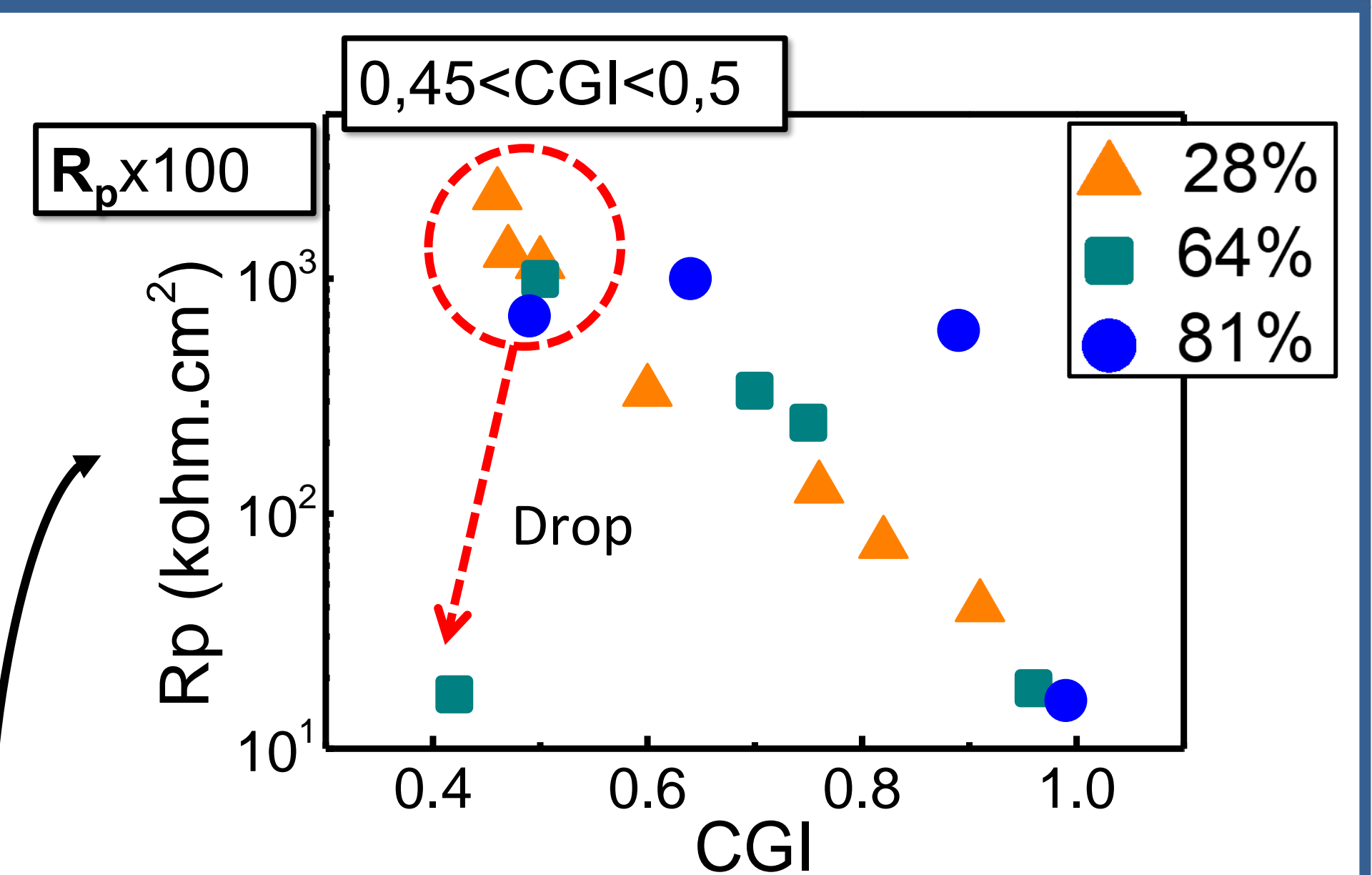

We optimized the CIGS absorber layer composition for indoor applications. The optimal range for **copper to Gallium/Indium ratio** is between **0.45 and 0.5** with the highest parallel resistance. However, if the CGI ratio drops below 0.4, there is a possible reversal of the doping, making the cell non-working.[3]

Contact

Maya El Khoury
L2C, PV2D, Montpellier
Email: Maya.el-Khoury@umontpellier.fr
Phone: +33605522983

References

- J. Bouclé et al., Solar 2023, 3(1), 161-183.
- A. Virtuani et al., Thin Solid Films 451, 160 (2004)
- T. Negami et al., Applied Physics Letters, 67(6):825-827, 7/24/2023 1995

Acknowledgments

This PhD is funded by **Region Occitanie** and **Programme d'investissement d'avenir PIA3 - Campus des Métiers et des Qualifications "Habitat, énergies renouvelables et éco-construction"** – IUT de Nîmes