



**HAL**  
open science

# Study and Evaluation of Local Area Network Architectures for Video Image Transmission

Bernard Cousin, Lotfi Kamoun

► **To cite this version:**

Bernard Cousin, Lotfi Kamoun. Study and Evaluation of Local Area Network Architectures for Video Image Transmission. International conference on Local Area Networks (IndoLAN'90), IFIP TC6, Jan 1990, Madras, India. pp.231-243. hal-04808086

**HAL Id: hal-04808086**

**<https://hal.science/hal-04808086v1>**

Submitted on 27 Nov 2024

**HAL** is a multi-disciplinary open access archive for the deposit and dissemination of scientific research documents, whether they are published or not. The documents may come from teaching and research institutions in France or abroad, or from public or private research centers.

L'archive ouverte pluridisciplinaire **HAL**, est destinée au dépôt et à la diffusion de documents scientifiques de niveau recherche, publiés ou non, émanant des établissements d'enseignement et de recherche français ou étrangers, des laboratoires publics ou privés.

# Study and Evaluation of Local Area Network Architectures for Video Image Transmission

Bernard COUSIN\*, Lotfi KAMOUN+  
ENSERB  
351 Cours de la Libération  
33405 Talence cedex  
FRANCE

We are interested in wide band local area network for image transmission on fibre optic. We study new architectures for videocommunication networks using electronic switching matrices. The matrix architecture enables numerous topologies to be built. We propose a software tool to evaluate these different topologies. We study two main topologies : the linear and the circular topologies. The evaluation shows the linear topology is better than the circular topology.

Logically, videocommunication networks include two subnetworks : one for image transmission, and the other for the command transmission. The first prototype implementation of our network uses two independent and specialized networks. We propose to integrate image and command subnetworks on the same medium. We propose two classes of architecture. The first class uses only a frequency division multiplex : a channel is assigned to the command transmission, the remaining channels are used for the image transmission. The second class includes a time division multiplex technique : on each channel the commands are mixed within the images. We conclude that, in relation to the state of art in video standards, the first class is better than the second until a universal video standard is created.

## 1. Introduction

The *Retine* project deals with the design of a local area network (LAN) for image distribution. Development of these networks is necessary to share the high cost of image equipment. Both analog video and digital image kinds are broadcast. Digital image involves the transmission of a large amount of information, so development of high speed local area network is essential for interactive and real time transmission. The physical medium used by this local area network is the fibre optic. Our fibre optic is seven kilometres long.

In fact, the *Retine* local area network includes three different networks. The first network is called *Carthage* [1]. It is an integrated services digital network with a throughput of 40 Mbit/s. It integrates voice and digital communications. It is fully operational and works as the university telephone exchange. The second network is under study. It is a very high speed network with a throughput of up to 560 Mbit/s. It is planned to enable the transmission of high resolution digital images between heterogeneous systems [2]. The third network is presented here. It is a network which uses electronic switching matrices linked by fibre optics via optoelectronic transceivers to transmit video images. This network has been entirely designed in our laboratory [3].

Switching matrices enable numerous topologies to be built. Thus, we propose a tool to evaluate the different topologies [4]. The tool explores all the possible configurations of a topology and so determines its appropriateness.

\* Laboratoire Bordelais de Recherche en Informatique (LaBRI)

+ Laboratoire pour l'intégration des composants et des systèmes électroniques (IXL)

Two aspects of design will be discussed in this paper after a short presentation : the evaluation of both circular and linear topologies (third paragraph); and the study of the architecture of the distributed management enabling the image equipment and the transmission components to be remotely controlled (fourth paragraph).

## 2. Presentation

When the distance between the LAN nodes is great (in the case of Retine more than 2 kilometres), and if high transmission rates are to be reached, the choice of transmission medium is primordial. Compared to other transmission media, **fibre optic** provides the advantage of having a wide bandwidth, a very low loss coefficient and a total immunity to electromagnetic interference. The distribution of the information over all the stations raises both light splitting and power loss problems. To solve these problems, we choose an optical point to point topology, and we build sophisticated electronics to process the received signal.

Figure 1 compares the bandwidth of **video image** transmission with **digital image** transmission. The bandwidth of digital transmission is obtained from the analog transmission applying the Nyquist theorem and a  $4^{bits}/5^{bits}$  encoding. Even with compression techniques digital transmission requires a wider bandwidth than analog transmission. The transmission of video images requires a bandwidth from 4 to 30 MHz, whereas the real time transmission of digital images with high resolution requires a bandwidth from 200 to 2100 MHz. Furthermore, very high speed digital networks require fast and expensive technology. Consequently, the first stage of the Retine project is to build an analog network to broadcast the video images.

Standard	Characteristics Lines/Hz/Scan	Format Width/Height	Band. (MHz)	Ref.	Sample frequency Lum. Chrom.	Rate (Mbit/s)	Band. (MHz)	Ref.
<b>Standard</b>								
PAL/Secam	625/50/2:1	4/3	5 to 6	[7]	13.5 6.75	216	270	[8]
NTSC	525/60/2:1	4/3	4.2	[5]	13.5 6.75	216	270	[8]
<b>Enhanced</b>								
super NTSC	1050/60/2:1	4/3	6	[6]	≥ 12 ≥ 6	≥ 192	≥ 240	
D2MAC	625/50/2:1	4/3 or 16/9	9	[7]	≥ 18 ≥ 9	≥ 288	≥ 360	
<b>HDTV</b>								
Muse(NHK)	1125/60/2:1	5/3	≤ 30	[6]	≥ 60 ≥ 30	≥ 960	≥ 1200	
Rs412(BBC)	1501/60/2:1	5/3	≤ 30	[6]	≥ 60 ≥ 30	≥ 960	≥ 1200	
HD-MAC v1	1250/50/2:1	16/9	≤ 30	[9]	72 36	1152	1440	[9]
HD-MAC v2	1250/50/1	16/9	≤ 30	[9]	144 72	1729	2160	[9]

Figure 1 - Analog and digital bandwidth for now and future video standards

Our network must assure efficient and flexible **functions**, such as remote control and access to image banks (optical disk, video tape recorder, ...), connexion to all sources of images (television, satellite channel, video camera, monitor, ...), image broadcasting for conferences or computer aided teaching, digital conversion and interactive processing of images, and remote control of videocommunication equipment.

To assure these functions, we propose the following general architecture (Figure 2). The LAN is made up of switching **matrices** located in different nodes. Each matrix has 16 input ends and 16 output ends. An input end enables transmitting equipment (e.g. a camera) to be connected to the matrix. An output end enables receiving equipment (e.g. a monitor) to be connected. Matrix output ends are connected to the transmitting end of the fibre optic through a transmitting optoelectronic coupler. Matrix input ends are connected to the receiving end of the fibre optic through a receiving optoelectronic coupler. The matrices are interconnected by fibre optics.

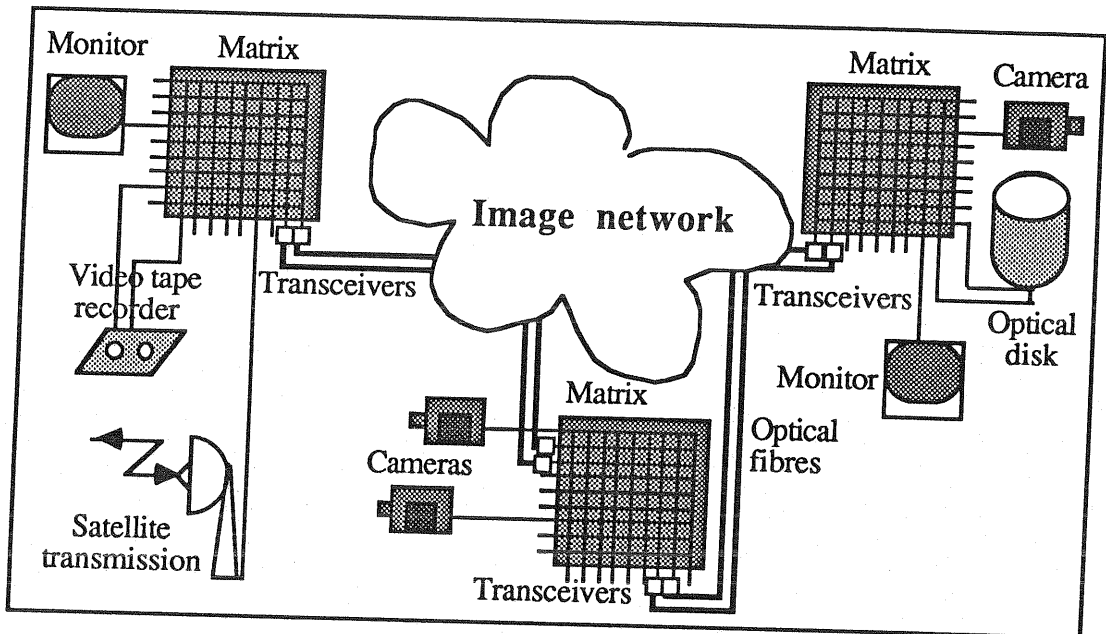

- Figure 2 - General architecture

The network architecture enables numerous topologies to be obtained. The two main topologies are the linear topology and the circular topology (Figure 3). The difference between these two topologies is relative to the way in which the matrices are interconnected. In the circular topology, each matrix is connected in an identical way : each matrix has two neighbors. While in a linear topology, the first and the last matrices are only connected to one neighbor. These two topologies are imposed by the linear installation of the fibre optic on the university campus. But, other medium topologies enable star or ring topologies to be considered.

It is to be noted that the two topologies use the same physical topology (four fibre optics), so their costs are approximately the same. To decide which is the best topology is not obvious. The circular topology is regular, but the linear topology has more connexions. And if we consider failures, the redundancy of connexions favours the linear topology toward link failures, whereas circular architecture favours the circular topology toward matrix failures. So, we propose a tool to enable the appropriateness and the fault tolerance of a topology to be evaluated.

### 3. Evaluation Tool

#### 3.1 Description

We define a topology  $T = \langle S, F \rangle$  by its set of stations  $S$ , and its set of links represented by the function  $F$ .  $F$  describes the number of links connecting each pair of stations. It is defined from  $S \times S$  into  $\mathbb{N}$ , where  $\mathbb{N}$  is the natural number set.

In our model, each link is unidirectional. If the real network allows bidirectional communication on the same medium, we modelize each medium by two links, one in each direction. In a similar way, each link allows one data unit to be transmitted. If the real network allows multiplex communication on the same medium, we modelize each channel by a link.

#### Example

The circular topology  $T_1 = \langle S, F_1 \rangle$  and the linear topology  $T_2 = \langle S, F_2 \rangle$  are described by:

$$F1 = \begin{bmatrix} 0 & 1 & 1 \\ 1 & 0 & 1 \\ 1 & 1 & 0 \end{bmatrix}, F2 = \begin{bmatrix} 0 & 2 & 0 \\ 2 & 0 & 2 \\ 0 & 2 & 0 \end{bmatrix}$$

We define the requirements  $U = \langle L, B \rangle$  by the set of logical connexions  $L$  which is required by the applications, and by the function  $B$  which enables the connexions to be weighed. The function  $L$  describes the number of useful connexions. It is defined from  $S \times S$  into  $\mathbb{N}$ . The function  $B$  modelizes the frequency of use or the importance of a connexion beside the others. It is defined from  $S \times S \times \mathbb{N}$  into  $\mathbb{R}$ , where  $\mathbb{R}$  is the real number set. The connexion concept enables the requirement to be described regardless of physical topology. The two functions  $B$  and  $L$  express the criteria enabling several different topologies based on the same stations to be rigorously evaluated. We normalize the function  $B : \sum_{i \in S} \sum_{j \in S} \sum_{k \in \mathbb{N}} B(i, j, k) = 1$ .

### Notations

$[k, l]$  denotes the matrix where the one element  $(k, l)$  is not null :

$$\forall i \neq k \in S, \forall j \neq l \in S [k, l](i, j) = 0, \text{ whereas } [k, l](k, l) = 1.$$

If  $M$  and  $N$  are two matrices,  $M \leq N$  denotes :  $\forall i \in S, \forall j \in S, M(i, j) \leq N(i, j)$ .

$\| M \|$  denotes the weight of the matrix  $M : \| M \| = \sum_{i \in S} \sum_{j \in S} M(i, j)$ .

### Example

Both topologies are evaluated beside the following requirements. The applications need two connexions between each station :

$$L = \begin{bmatrix} 0 & 2 & 2 \\ 2 & 0 & 2 \\ 2 & 2 & 0 \end{bmatrix}$$

The requirements are fairly distributed among all the connexions :

$$\forall i \in S, \forall j \in S, \forall k \in \mathbb{N} \dots L(i, j), B(i, j, k) = 1 / \| L \|.$$

$$B_{k \in \{1,2\}} = \begin{bmatrix} 0 & 0.08334 & 0.08333 \\ 0.08334 & 0 & 0.08334 \\ 0.08333 & 0.08334 & 0 \end{bmatrix}, \begin{bmatrix} 0 & 0.08333 & 0.08333 \\ 0.08333 & 0 & 0.08333 \\ 0.08333 & 0.08333 & 0 \end{bmatrix}$$

A logical connexion links two stations using one or more physical links. This set of physical links makes up a path from the starting station to the arrival station, and this set is called the **support** of the connexion. One connexion can have more than one support (Figure 4). This redundancy enables the network to be fault tolerant.

The function  $H_F$  associates to each logical connexion its supports. It is defined from  $S \times S$  into  $S \times S \times \mathbb{N}$ . The set of physical links modelized by the matrix  $M$  is a support of the connexion between the sites  $i$  and  $j$ , if and only if  $H_F(i, j) = M$ , which is denoted by :

$\exists n \in \mathbb{N}$  such that  $M = \sum_{k \in \{1..n\}} [i_k, j_k]$  with

(1)  $\forall k \in \{1..n\}, [i_k, j_k] \leq F$ ,

(2)  $i_1 = i, j_n = j$ , and  $\forall k \in \{1..n\} j_k = i_{k+1}$ ,

(3)  $\forall k \in \{1..n\}$ , if  $\exists l \in \{1..n\}$  and  $i_k = i_l$  then  $j_k = j_l$ .

- (1) The set of physical links is included in the physical topology  $F$ , (2) and makes up a path (3) without cycle from the station  $i$  to the station  $j$ .

### 3.2 The graph

We explore the graph of all the possible configurations which can be accepted by a given

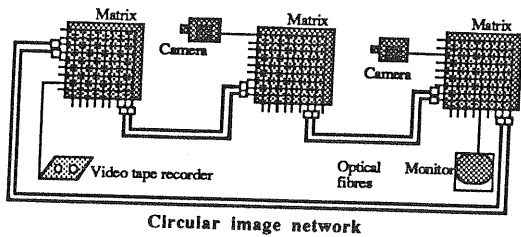

Circular image network

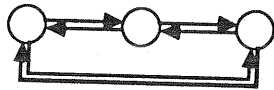

- Figure 3a- The circular topology -

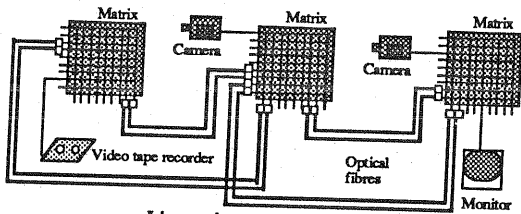

Linear image network



- Figure 3b - The linear topology -

- Figure 4 - A connexion and its supports

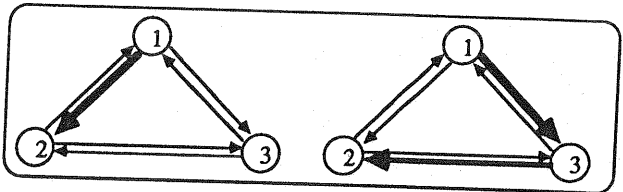
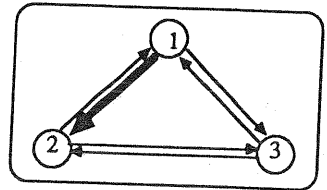

- Figure 5 - A configuration and its supports

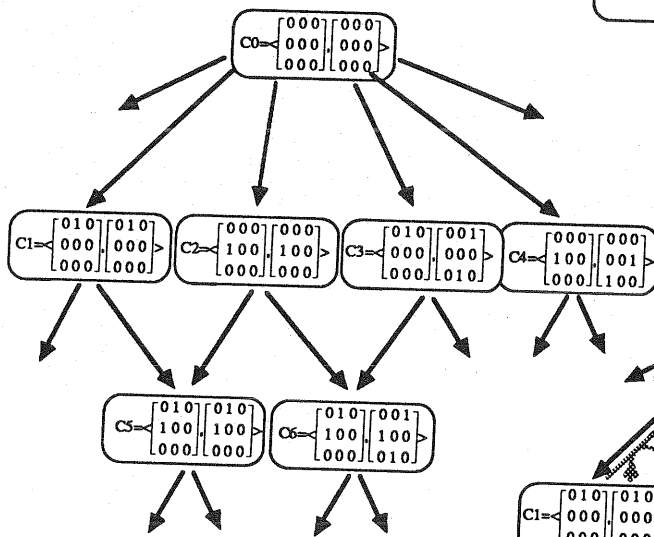
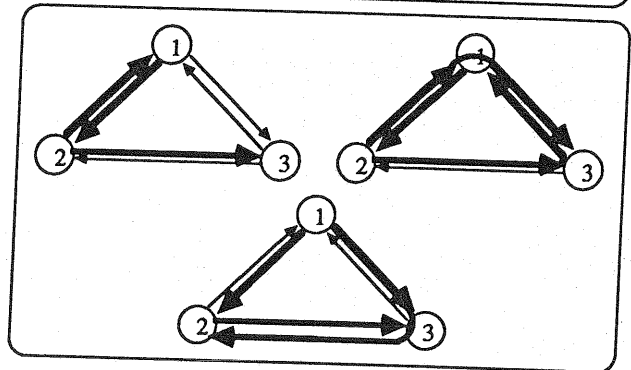
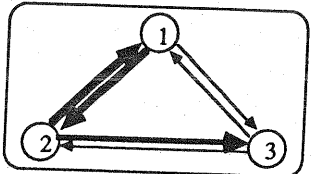

- Figure 6 - The configuration graph -  
notation : configuration = <logical connexion matrix, its support >

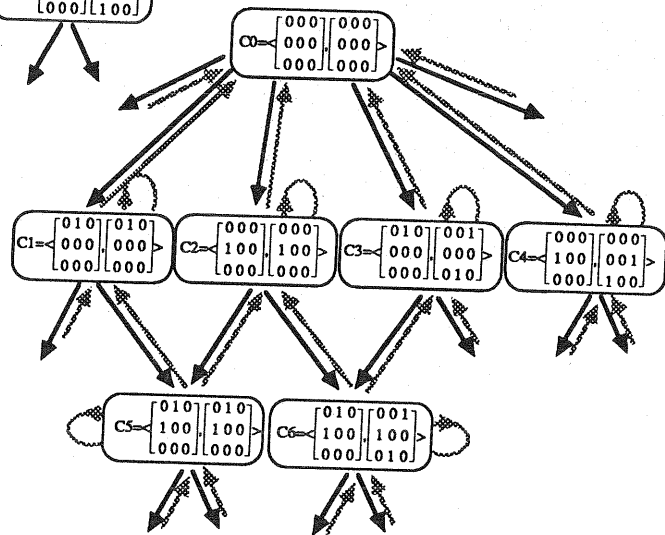

- Figure 7 - The Markov chain -

topology. A configuration is made up of a set of connexions which can be simultaneously settled in the topology. A configuration is a snap shot of a state of the network. The support of a configuration is made up of the supports of all the connexions settled. As one connexion can have more than one support, one configuration can have more than one support (Figure 5).

The function  $R_F$  associates to each configuration its supports. It is defined from  $S \times S \times N$  into  $S \times S \times N$ . The matrix  $M$  is a support of the set of connexions "e", if and only if  $R_F(e) = M$ , which is denoted by :

- (1)  $\exists n \in N$  such that  $e = \sum_{k \in \{1..n\}} [i_k, j_k]$ , and
- (2)  $\exists h_k \in H^F [i_k, j_k]$  such that  $M = \sum_{k \in \{1..n\}} h_k$ , and
- (3)  $M \leq F$ .

(1) "e" can be split up into a set of logical connexions; (2) "M" can be split up into a set of physical links which are the supports of the previous connexions; (3) this set of physical links must be included in the physical topology.

The evaluation of a topology requires the evaluation of all its configurations. The evaluation of a configuration requires the drawing-up of which required connexions are settled or can be settled from this configuration. The required connexions are listed by the function  $L$ . Thus we need to know all the children of a configuration. A child of a configuration is a configuration which can be obtained by adding a new connexion to its father configuration. Consequently, we get a graph of configurations. Figure 6 describes a part of the graph of the topology  $T_1$ .

The graph  $G = \langle C, A \rangle$  of a topology  $T = \langle S, F \rangle$  is defined by the set  $C$  of the configurations which are the vertices of the graph, and by the function  $A$  which describes the edges.

The set  $C$  is denoted by :

$C = \{ \langle e, p \rangle \text{ such that } e : S \times S \rightarrow N \text{ with } e \leq L, p : S \times S \rightarrow N \text{ with } p \leq F, \text{ and } p \in R^F(e) \}$ .  
A configuration is a couple based on a set of logical connexions "e", and one of its supports "p". Each logical connexion of the set must be required ( $e \leq L$ ), and the support must be compatible with the physical topology ( $p \leq F$ ).

The function  $A$  is defined from  $C$  into  $C$ . Two configurations are associated if and only if :

- $\exists i \in S, \exists j \in S$  such that  $e_1 + [i, j] = e_2$ , and
- $\exists c \in H^{F-p_1}([i, j])$  such that  $p_1 + c = p_2$ .

### 3.3 Evaluation function

The evaluation function  $V$  is defined by the following functions.

The function  $X$  denotes the probability of settling  $k$  connexions  $[i, j]$  from a given configuration  $c$ . If we denote  $Child(c) = \{k \text{ as } k = A(c)\}$ ,  $X$  is defined from  $C \times S \times S \times N$  into  $\mathbb{R}$  by :

$$X(c, i, j, k) = \begin{cases} \text{if } Child(c) \neq \{\} \text{ then } \sum_{f \in Child(c)} X(f, i, j, k) / \| Child(c) \| \\ \text{else if } e(i, j) \geq k \text{ with } c = \langle e, p \rangle \text{ then } 1 \text{ else } 0. \end{cases}$$

The function  $Y$  denotes the probability of settling  $k$  connexions  $[i, j]$  from any configurations of a topology. It is defined from  $S \times S \times N$  into  $\mathbb{R}$ . To establish the function  $Y$  the state probability  $E$  of each configuration needs to be known. The state probability of a configuration is the frequency that the network is in this configuration.  $Y(i, j, k) = \sum_{c \in C} X(c, i, j, k) \cdot E(c)$ .

So we can assess the evaluation function  $V$  of a topology  $T = \langle S, F \rangle$  beside the requirements  $U = \langle L, B \rangle$ . The evaluation function is defined into  $\mathbb{R}$ .

$$V^T_U = \sum_{(i,j) \in S \times S} \sum_{k \in N} Y(i, j, k) \cdot B(i, j, k) .$$

### 3.4 State probabilities

The state probability  $E$  associated to each configuration can be obtained knowing the probability law that the network changes from one configuration to another. If we know the probability laws to open or to close a connexion, and if these laws are exponential, then the configuration graph can be changed in a Markov chain.

We add an opposite edge between the configurations  $c1$  and  $c2$ , if an edge exists between the configurations  $c2$  and  $c1$ . We associate the disconnexion probability with the first edge, and the connexion probability with the second edge. We add a loop to each configuration. We associate the probability of remaining in this configuration with each loop. Figure 7 describes the Markov chain obtained from the configuration graph of Figure 6.

The Markov chain is modeled by the probability matrix  $PM$  defined from  $C \times C$  into  $\mathbb{R}$ .

$$\forall c1 = \langle e1, p1 \rangle \in C, \forall c2 = \langle e2, p2 \rangle \text{ as } A(c1) = c2, PM(c1, c2) = Pe(e2 - e1).$$

$Pe$  is the connexion probability function defined from  $S \times S$  into  $\mathbb{R}$ .

$$\forall c1 = \langle e1, p1 \rangle \in C, \forall c2 = \langle e2, p2 \rangle \text{ as } A(c2) = c1, PM(c1, c2) = Pr(e1 - e2).$$

$Pr$  is the disconnexion probability function defined from  $S \times S$  into  $\mathbb{R}$ .

We associate the probability of remaining in a configuration with the diagonal elements of the matrix. The normalization imposes their values :

$$\forall c1 \in C, PM(c1, c1) = 1 - \sum_{c \in C - \{c1\}} PM(c1, c) .$$

All the others elements of the matrix are null.

If the stationary condition is fulfilled, we must resolve the following equational system to get the state probability  $E$  of the configurations.

$$PM \cdot E = E$$

### 3.5 Resolution

If, respectively, all the connexion probabilities and the disconnexion probabilities are equal, we prove an original result [11]. We prove that the state probability of being in a configuration can be achieved without computing the associated Markov chain. This result speeds up the topology evaluation process.

#### Theorem

If the connexion probability and the disconnexion probability are constant :

$$\forall i \in S, \forall j \in S, Pe([i, j]) = Pe \text{ et } Pr([i, j]) = Pr$$

Then the state probability  $E$  of each configuration  $c$  can be established by :

$$\forall c = \langle e, p \rangle \in C, E(c) = (Pe / Pr)^{\|e\|} / \gamma, \text{ with the normalization constant : } \gamma = \sum_{c \in C} E(c) \otimes$$

If we denote the ratio between the connexion probability and the disconnexion probability by :  $\beta = Pe / Pr$ , the mean number of settled connexions is :  $Nm = \sum_{c \in C} \beta^{\|e\|} / \gamma \cdot \|e\|$ .

The evaluation of the fault tolerance of a topology can be achieved with the same evaluation function. It is sufficient to evaluate the original topology without a physical link, or without a station. The result of the evaluation must be weighted by the probability of such a failure appearing.



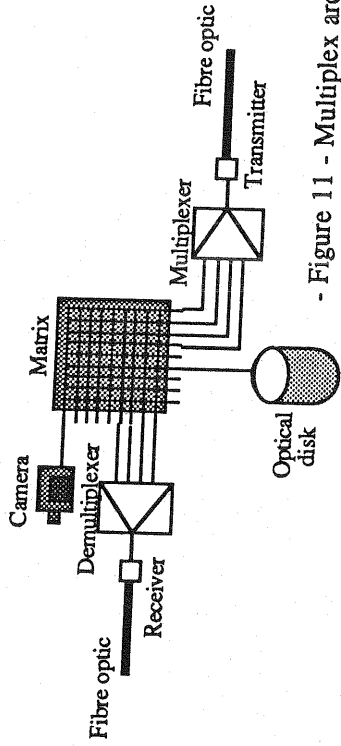
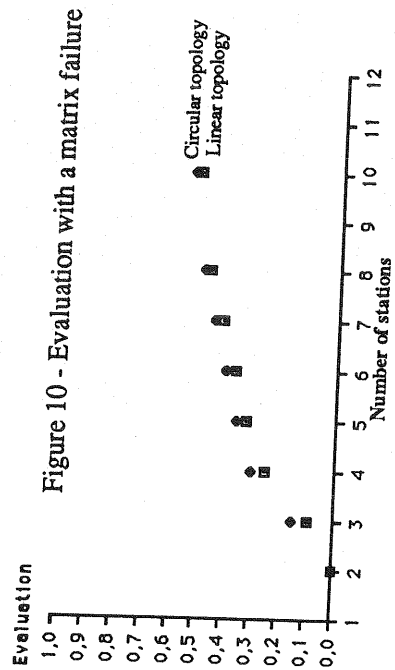
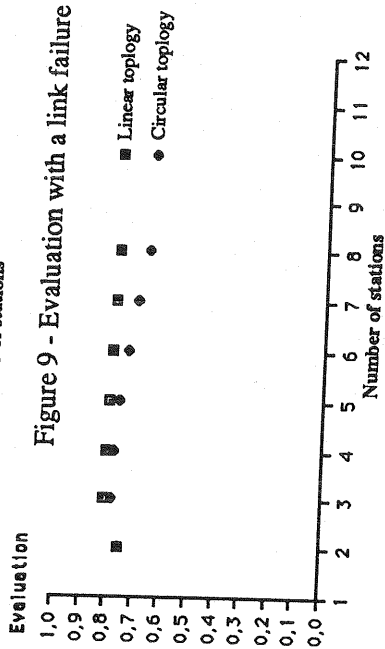
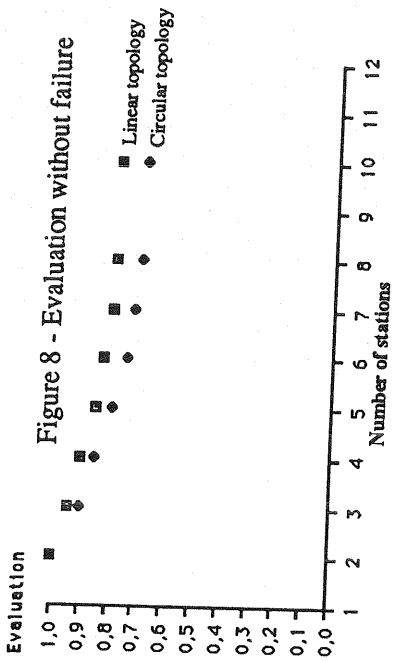

- Figure 11 - Multiplex architecture -

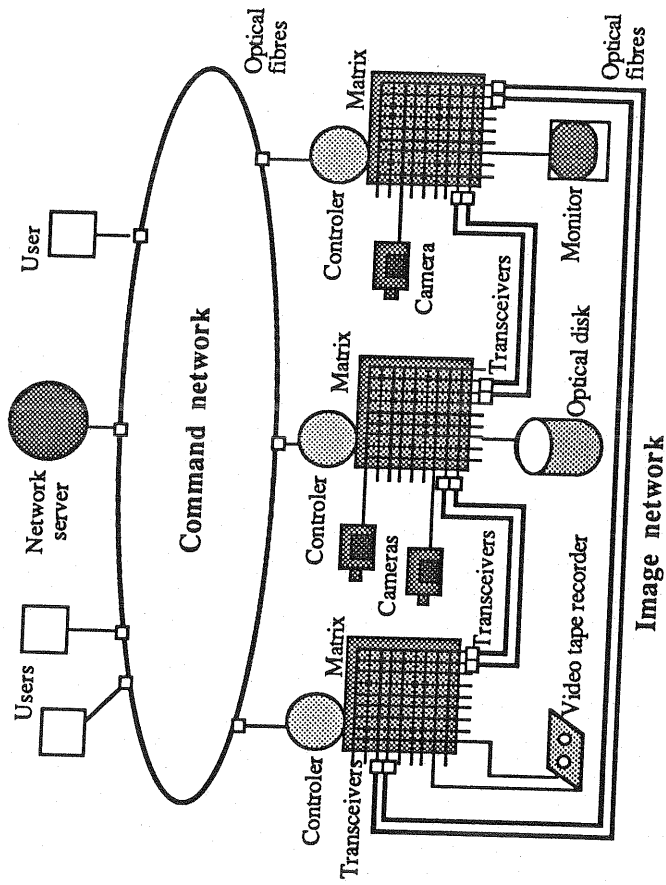

- Figure 12 - Global Architecture -

## 4. Architecture

### 4.1 Topology evaluation

We have evaluated the linear and the circular topologies with 2,3,4,5,6,7,8 and 10 stations. The curve of Figure 8 shows that the linear topology is better than the circular topology with the video equipment spending ten per cent of its time connected up. For other ratios, the results are similar. Taking the failures into account, Figure 9 shows that the redundancy of the linear topology favours its link fault tolerance. Nevertheless, Figure 10 shows the opposite towards matrix failure, because matrix failure splits into two parts the linear topology, whereas the circular topology remains entire. The global evaluation of both topologies with a link failure probability equal to  $10^{-6}$  and a matrix failure probability equal to  $10^{-6}$  proves that the linear topology is better than the circular one.

### 4.2 Architecture Improvement

It has been shown previously that the bandwidth of the video signal are at most 30 MHz, whereas fibre optics enable a wide bandwidth to be used. We propose to multiplex several channels into one fibre optic allowing all the bandwidths to be covered. We use for this purpose a frequency division multiplex (FDM) technique.

So, we add into our architecture a **demultiplexer/multiplexer** between the fibre optic and the input/output ends of each matrix (Figure 11). The increase in channels provokes an increasing use of the matrix ends. Thus, less equipment can be connected to the remaining ends of the matrix. The linear topology is more sensitive than the circular topology to this phenomenon. With 16 input and 16 output end matrix, two pairs of fibre optics, and four channels per fibre optic, the inner matrices are saturated. No equipment can be connected ! To manage these problems, we propose a larger matrix with more input/output ends, or a cascaded assembly of several matrices.

The evaluation of both circular and linear topologies again shows the better performance of the linear one. However, the difference is less marked than in the previous architecture without multiplexer. We explain these alleviations of difference by the two following points : as the number of channels increases, the relative importance to obtain one more channel decreases; the linear topology remains disadvantaged by matrix failure which splits the set of stations into two parts.

### 4.3 Command Network

Each matrix is locally controlled by a **controller** based on a microprocessor. A **server** located on a distant processor makes the overall management of the video network (Figure 12). The server, the controllers and the users communicate with each other through a command network. The architecture of the command network is studied here.

The functions of the controller associated to each matrix are the following (Figure 13):

- the management of the local switching matrix through the matrix line (ML);
- the management of the local equipment through the equipment lines (EL);
- the support of local terminals if necessary through the terminal line (TL);
- the management of the information exchanged with the distant server through the command channel (CC).

The server gets the connexion or disconnexion requests from the users, computes the routing algorithm to establish the connections from the sources to the sinks using several matrices, and sends the commands to the appropriate controllers. The server ensures the overall administration of the LAN (supervision, consistency, accounting, ...). It manages the controller and the switching matrices (remote software loading, configuration, controller and matrix states, ...). It exchanges commands with controllers to establish the video equipment

connexions. In addition to that, the server can remotely control the video equipment, which can be connected to the nearest matrix.

Logically, we can see two networks : the video transmission network broadcasts the images; the command network supports the management messages exchanged between the users, the server and the controllers.

Two main ways of implementing the command network exist : the first way is to have two independent and specialized networks, one analog network for image transmission and one digital network for management; the second is to have an integrated network.

The first prototype implementation of our network uses the first architecture [3]. One pair of fibre optics is used to broadcast the video images through matrices, another pair of fibre optics is used with the Carthage protocol to send the commands from the users to the server and from the server to the controllers. This architecture has been chosen because it was straightforward (the Carthage network was fully operational), and because several fibre optics covering all the campus were available. But this architecture duplicates the networks and increases their cost.

Consequently, we propose integrating the image network and the command network into the same medium. The Retine project can be seen as composed with progressive integration steps:

- 1 - The first prototype implements the image transmission and the command transmission on separate networks using the same type of medium : two pairs of fibre optics.
- 2 - The current prototype wants to integrate both transmissions on the same medium : one pair of fibre optics. In this paper, we study several techniques enabling this multiplexing.
- 3 - The final step of the project will be to obtain complete integration using the same protocol to achieve the image and the command transmission on digital network.

Two classes of architecture can be considered : they differ from each other in the process integration of the commands and the images in the same medium. The first class uses only a frequency division multiplex (FDM) technique. A channel is assigned to the command transmission, the other channels are used for the image transmission. The second class of architecture includes time division multiplex (TDM) techniques. On each channel the commands are mixed within the images.

#### 4.4 First architecture class

If a channel is assigned to the command transmission, we can choose to connect the controller to the channel either through the matrix, or directly. The use of the matrix enables different channels to be chosen to transmit the commands. This architecture is fault tolerant, nevertheless it uses one input and one output matrix ends.

In both cases, a ring must be established using the channels associated to the command subnetwork to connect all the matrix controllers to the server. Then, a digital standard local area network protocol can be used.

#### 4.5 Second architecture class

The general architecture is shown in Figure 14. A command **mixer/extractor** is inserted between the matrices and the multiplexers. They enable the insertion/extraction of the commands into/from the images. In this case, the controllers manage several independent command channels.

Image and command multiplexing can be achieved by the following techniques : The commands are included within each image. The commands use the slot time where the video signal associated to the image is not significant and not used.

To understand this technique used to include a command in one image, it is necessary to

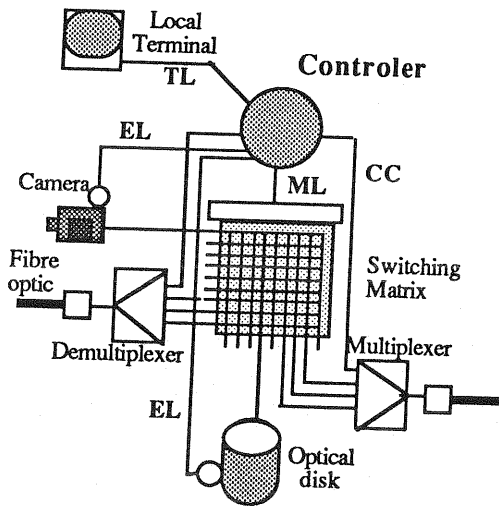

- Figure 13 - Functions of the controller -

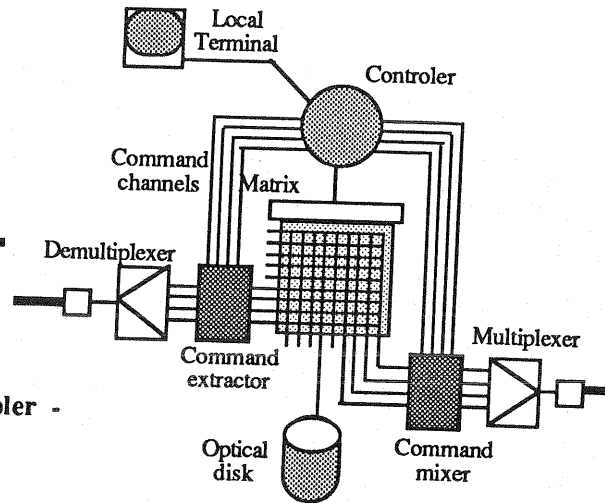

- Figure 14 - Command extractor/mixer -

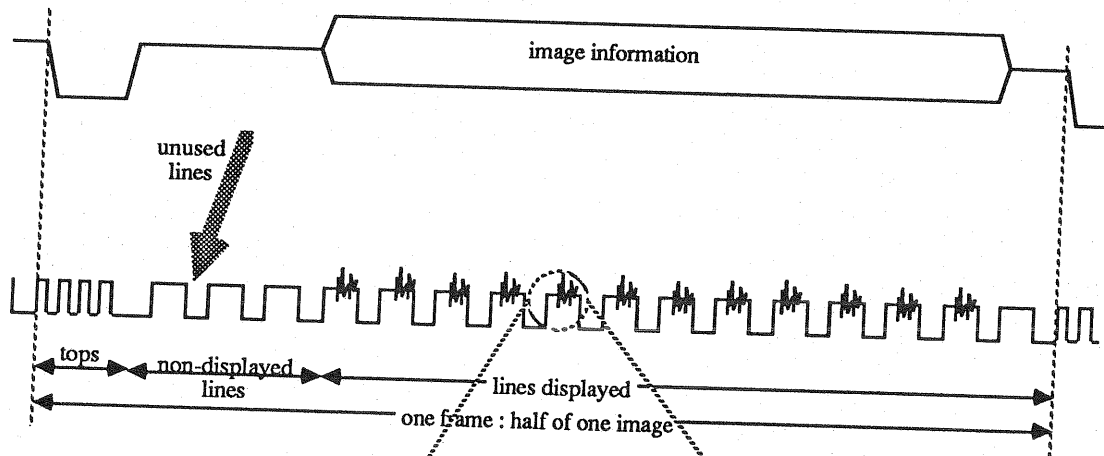

Figure 15 - the general video frame coding -

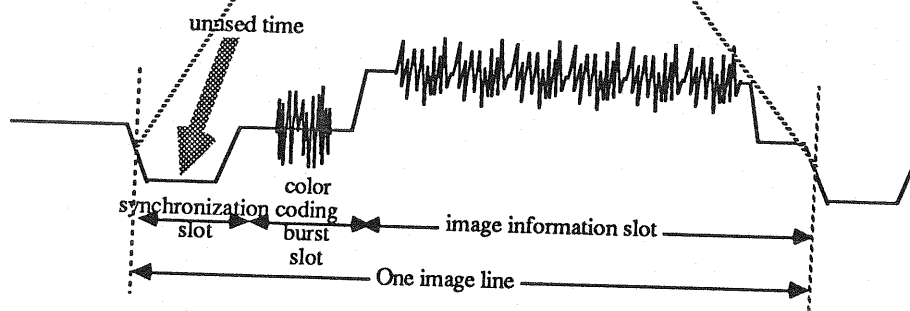

Figure 16 - The general video line coding -

consider the general format of video signal standards. In the television standards codes (PAL, SECAM, NTSC\*), there are 625/525\* lines in an image. An image is constituted of 2 to 1 interlaced frames. Some lines (about 25 frames) are not displayed on the TV screen (Figure 15).

An effective transmission rate of about 180 Kbit/s can be reached, if we include the command information in the remaining lines, with a transmission rate of 4 Mbit/s which is compatible with the channel bandwidth.

Moreover, each line includes a synchronization slot, a color coding burst slot, and an image information slot. There is a short duration into the synchronization slot which is not significant, and thus, which can be used to include digital information (Figure 16). An additional effective transmission rate can be reached using both methods.

Both the synchronization and the maintenance of the shape frame are difficult problems to solve. The mixer/extractor includes digital command information with a time reference based either on the synchronization tops of the image source if it exists, or if none, on its own time reference which will synchronize the down stream neighbor station.

The advantages of this technique are its great availability since a command can be transmitted at any instant, and a very efficient use of the bandwidth : unused period of image transmission coding is used to transmit the commands. The disadvantages concern the complex implementation due to the complex synchronization required, and the difficulty of managing the numerous video standards. Integrating commands into the images suffers from the great variety of current video standards. Also, new standards use different frame formats, new transmission techniques, and a wider bandwidth for high definition TV than current TV. Obviously, to achieve best rate performance the above two techniques can be mixed.

So, the first class of architecture which used a dedicated channel to assume the command transmission is more adapted to the multiplicity of present and future video standards. This is true for the following two reasons : straightforward implementation, and easy management of the command channel which is independent of the image channels; no investigation and no sophisticated method is required related to the numerous standards due to the transparency architecture used.

## 5. Conclusion

We have studied a new architecture for a video communication network. Our architecture is based on electronic switching matrices and fibre optics. Fiber optic has been chosen due to both its large bandwidth enabling high speed transmission, and its weak power loss enabling a large field to be covered.

The switching matrix architecture enables numerous topologies to be built. We have proposed a software tool TOPE to evaluate these different topologies. The two main studied topologies are the linear and the circular ones. The evaluation shows the linear topology is better than the circular topology. So the RETINE project uses the linear topology.

For optimal use of the fibre optic bandwidth, a frequency multiplexer is added to our architecture. The FDM technique enables several transmission channels to be implemented in one fibre optic. The tool proves that the evaluation of the linear topology remains higher than the circular topology.

In previous paper, we have introduced a videocommunication LAN using two independent subnetworks : one for image transmission, and one for command transmission. We discuss here the possibilities of the integration of the command subnetwork with the image subnetwork. Two solutions are proposed. The first architecture class uses one channel for

command transmission and the other channels for image transmission. The second architecture class uses TDM techniques to integrate the commands and the images in the same channel. We conclude relating to the state of the art in video standards, that the first architecture class is better than the second, until a universal video standard is created, unless we choose to broadcast only one current standard.

The design of our videocommunication LAN uses a modular concept. This modularity preserves for both hardware and software investment. The architecture allows new improvements to be incorporated, making future growth possible without major changes. The TOPE software remains a good tool for the evaluation of these new topologies.

## References

- [1] Documentation technique du réseau local Carthage. LCT 6500. 1986.
- [2] R.Castanet, X.Navarro. Networks for image transmission. Euteco 88. Vienne-Austria, April 1988.
- [3] H.Henry, L.Kamoun, A.Mora. Local area network for video image transmission. Data communication technology. Limerick-Eire, September 1988.
- [4] B.Cousin. TOPE : manuel d'utilisation (version 0.6). Talence-France, April 1989.
- [5] K.A.Prabhu. Digital 's advantages in video transmission. Lightwave, journal of fibre optic, pp28-30, May 1988.
- [6] R.W.Lay. What is Super NTSC. Lightwave, journal of fibre optic, p9, October 1988.
- [7] E.Launet. Les premiers pas de la télévision haute fidélité. Sciences et techniques, n°42-43, p32, November 1987.
- [8] Paramètres de codage de télévision numérique pour studios. Avis 601 du CCIR, 1982.
- [9] La TVHD grâce à Eurêka. Antennes n°8, pp16-18, 1988.
- [10] S.S.Wagner. Optical amplifier applications in fibre optic local networks. IEEE transactions on communications, Vol COM-35, n°4, April 1987.
- [11] B.Cousin. Evaluation des topologies. Rapport de recherche LaBRI n°89-79. France, Mai 1989.
- [12] A.M.Johson, M.Malek. Survey of software tools for evaluating reliability, availability and serviceability. ACM computing surveys, vol 20 n°4, December 1988.
- [13] M.Lesk. Diamètre de graphes et qualité de service d'un réseau de données. RAIRO recherche opérationnelle, vol 18 n°3, August 1984.
- [14] J.M.Mepuis. CREDO : Configurateur de réseaux de données. Echo des recherches, n°110, Octobre 1982.
- [15] L.Kleinrock. Queuing systems. Vol 1&2 : theory & applications, John Wiley, 1976.
- [16] M.Minoux. Multiflôts de coûts minimums avec fonctions de coûts concaves. Annales des télécommunications, vol 31 n°3-4, 1976.
- [17] R.Sharp, M.Show, M.Jensen, J.Sparso. Architectural considerations in LAN-dth. Symposium on local communication systems. Toulouse-France, November 1986.