



HAL
open science

RETINE: an academic fiber optic network for image transmission

Richard Castanet, Bernard Cousin, Lofti Kamoun, Xavier Navaro, Omar Rafiq, César Viho

► **To cite this version:**

Richard Castanet, Bernard Cousin, Lofti Kamoun, Xavier Navaro, Omar Rafiq, et al.. RETINE: an academic fiber optic network for image transmission. 3rd Conference on Computer Communications (Africom- CCDC), IFIP TC6/ICCC, May 1991, Tunis, Tunisia. hal-04807918

HAL Id: hal-04807918

<https://hal.science/hal-04807918v1>

Submitted on 27 Nov 2024

HAL is a multi-disciplinary open access archive for the deposit and dissemination of scientific research documents, whether they are published or not. The documents may come from teaching and research institutions in France or abroad, or from public or private research centers.

L'archive ouverte pluridisciplinaire **HAL**, est destinée au dépôt et à la diffusion de documents scientifiques de niveau recherche, publiés ou non, émanant des établissements d'enseignement et de recherche français ou étrangers, des laboratoires publics ou privés.

RETINE: an academic fiber optic network for image transmission

R CASTANET (1), B. COUSIN(1), L KAMOUN(3), X NAVARO(1), O RAFIQ(2), G VIHO (1)

351 Cours de la Libération
F 33405 TALENCE cedex (FRANCE)

(1) Laboratoire LaBRI (2) Université de PAU (3) Laboratoire IXL

ABSTRACT

This report documents the necessary phases in the installation of a local area network with high throughput for image transmission in an academic setting: specification of requirements for transmission of digital and analog video images; specification of a service to implement the OSI application layer; specification of a communication protocol; verification of the efficacy of this protocol; verification of its conformity; and testing of its interoperability after implementation.

This report culminates several years of experience by our team in researching networking and protocols.

1. INTRODUCTION AND SPECIFICATION OF NEEDS

Recognizing that images are being used more and more as the basis for conveying information, we developed project RETINE (REseau de Transmission d'Images Numérisées pour l'Economie de l'aquitaine, or network digitized image transmission) on the campus of the University of Bordeaux in Talence. The project entailed the collaboration of users, who specified their needs, with teams in the fields of both electrical engineering and computer science, for the design and actual implementation.

The needs analysis revealed the necessity of a network for, on the one hand, analog transmission of video, and on the other, digitized transmission at high throughput for images.

Services in video mode include the following: self-training service; remote teaching; documentation; pedagogical illustration through access to a video-library or image banks supported by a computer-controlled array of video disks or video cassette recorders (VCRs); university information and videocommunication service with access to a television production department for television rebroadcast, selectively forwarding local, national, and international television programs received by cable or over satellite channels; service for forwarding images to digitizing stations; telesurveillance service for buildings and equipment on the campus.

Services in the high throughput digitized mode include the following: storage and/or transmission of images from point to point; transmission of sequences of images, either independently or linked, as in a film sequence; search of a collection of images, with the option of progressive or partial transfer of these images.

The medium for these two types of services is a multi-mode fiber optic at 300 MHz.km bandwidth. It is widely known that transmission of video images requires a bandwidth of 4-30 MHz and that high definition digitized images require 200-2000 MHz. In this latter case, compression techniques--both within and between images enable to exploit a narrower bandwidth.

In this article, we present the different phases of definition and implementation of the two types of networks. In this work, we have enjoyed the benefit of more than ten years of experience in the field of networking and in implementing OSI (Open System Interconnection) protocols.

The second section of the paper presents the characteristics of the video transmission network, especially its electronic and computing aspects. The third section explains the service at the OSI application layer as well as its protocol for digitized images. The fourth section compares the characteristics of protocols or techniques used for high throughput, in particular FDDI (Fiber Data Distributed Interface) and ATM (Asynchronous Transfer Mode). The fifth section describes the electronic architecture of the digitized image communication system. In the sixth section, we outline the validation and verification techniques used for the protocols. The final section includes the testing methods exercised to check the conformity and interoperability of the protocols as they were implemented. In sum, we offer a complete synopsis from the definition, to the validation and testing of communication protocols for image transmission.

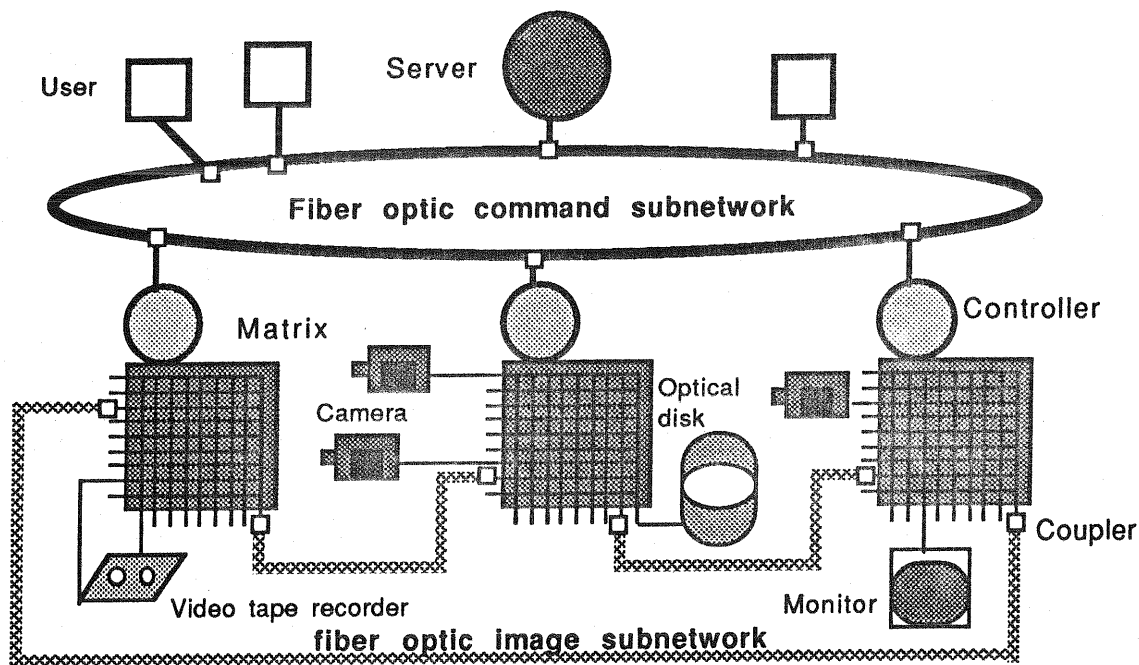

Figure 1: General architecture of videocommunication network

2. VIDEOCOMMUNICATION NETWORK

2.1 General architecture of the network

A functional schematic drawing of the network appears in Figure 1. We can distinguish two subnetworks in the videocommunication network:

1. The subnetwork of video images, formed by a group of switching matrices (16 in-ports, 16 out-ports) located in different laboratories on the campus and connected by fiber optic links. Each switch is controlled by a command system (SMCS: Switching Matrix Control System) which is based on microprocessors.

2. The command subnetwork uses a microcomputer server as an interface with the users for establishing connections with the resources of the network. The server also manages equipment, communication, and traffic on the network [KAM 90a]. The command subnetwork, which links users, SMCS controllers, and their server, is made up of a local network MATRACOM in a ring at 40 Mbits/s.

2.2 Topology of the video network

The two basic topologies are linear (Figure 2) and circular (Figure 3). In a circular topology, each node is connected in an identical manner: every node has two neighbors. In a linear topology, the first and last nodes are each connected to a single neighbor.

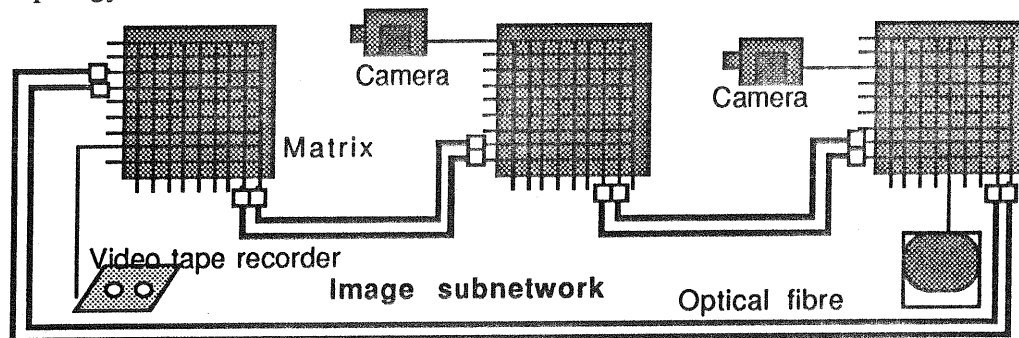

- Figure 2- Circular topology -

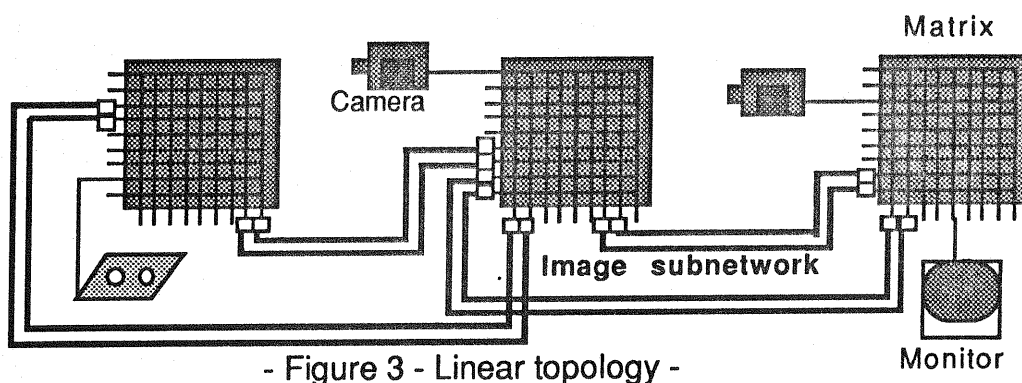

- Figure 3 - Linear topology -

A study was undertaken to evaluate these topologies [COU 90a]. TOPE, software based on calculations of Markov chains, enabled us to conclude that a linear topology is best if the video equipment is connected on average 10% of the time. For other values, the results are identical. Taking account of failures, we can show that the redundancy of a linear topology promotes fault-tolerance in the event of failures in the links. At the same time, our evaluation shows the opposite tendency in the event of break-down of a matrix because such failures divide a linear network into two parts, whereas a circular topology preserves the connectivity of the network. The general conclusion led us to choose a linear topology.

2.3 Electronic architecture [KAM 88]

The basic principle of matrix electronic architecture is the association of 16 multiplexer circuits 16/1 MUX in order to form a matrix 16 by 16. The implementation uses strict rules to minimize noise introduced by switching. It also introduces buffers to avoid distortion of signals. Using a switching technique in T at the interior of the MUX increases the isolation between the input and output ports and, of course, diminishes diaphonic interference. This assembly offers good linearity for phase shift between the input and output as a function in the frequency domain, guaranteeing very good transmission of video signals.

The switching matrix control system (SMCS) is designed around a 68000 microprocessor at 8 MHz with a VME bus and G64 bus. Control of the matrix is managed by five PIA (Peripheral Interface Adaptor), among which four are used for addressing to select the input row for each MUX and the fifth is for validation/inhibition of each MUX to select the output column. Software facilitates communication with the server and control of the matrix. The command primitives are OPEN, CLOSE, READ (row number, column number of the matrix).

Complementary studies [KAM 89] and [KAM 90b] have been undertaken in order to optimize this network for videocommunication.

2.4 Communication management [AYA 89]

The primary service expected from this network is connection between a sending site and one or more receivers. To insure this service, the video server uses a local network (MATRACOM) as a subnetwork for control and command. Following a request for a connection coming from a user, the server determines the best path between the sender and receiver. This transaction entails the following steps: connection between the server and the network; connection between the server and the controller of matrix; transmission of the command primitives in order to set up a video circuit according to the remote procedure call protocol; reception of the results of switching; disconnection of the server from the controller; disconnection of the server from the network.

The management of the network is carried out by a group of functions in line with OSI standards: configuration management (resources, status and distribution of software); directory management (maintenance of mapping between resource-type names, resource names and addresses), management of routing, fault and report management.

A system of supervision is carried on by graphic representation in real time of the active ports on the matrices as well as on the fibers in use. For users, there is access directly to commands or access through menus in graphic mode as well.

3. THE DIGITIZED IMAGE TRANSMISSION SERVICE

A great deal of work has already been published in the field of image transmission, including studies in basic techniques such as ATM [COU 87], studies of the framework of networks for the integration of services ISDN [DIC 87], studies or proposals for standards for files of images such as CGM (Computer Graphic Metafile) [ISO 87a]. We propose an application level service, notably ITAM (Image Transfer Access and Management) in the OSI context of heterogeneous equipment for image transmission.

3.1 Presentation of the OSI application layer [ISO 95]

ISO (International System Organization) document number 9545 describes the cooperative functioning of open systems in terms of interaction between application processes (AP). The aspects of an AP that have to be taken into account in OSI terms are represented by one or more application entities(AE). An AE represents a group of OSI functions available to the application.

In order to permit two AEs to communicate, one or more application service elements (ASE) are set up, each one of them representing a group of functions furnished by the OSI communication layer. These functions are defined by the specification of a group of application protocol entities (APDU) and by the protocol managing their use between two ASEs of the same type.

To implement an AE, we define one or more single association objects (SAO) modeling the functions and the information of the AE. Coordination of the SAOs is insured by a group of association control functions (See Figure 4). The normalized association control service element (ACSE) insures a liaison with lower OSI levels (for example, the presentation layer) for every SAO .

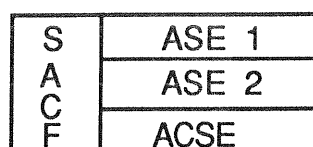

Figure 4 : Structure of SAO

3.2 Proposed architecture for an image transfer application entity [CAS90]

To insure an image transfer service, we use two normalized ASEs, one for the transfer of files, or the FTAM [ISO 87b], and the other for the virtual terminal, or the VT [ISO 86] to take into account the characteristics of graphic terminals and compression techniques (See Figure 5).

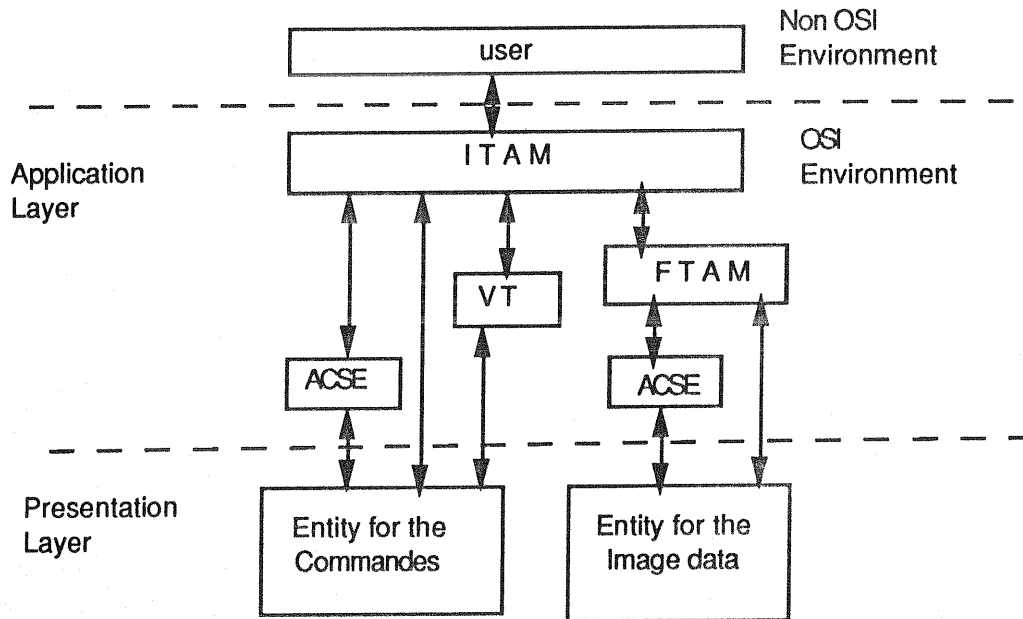

Figure 5: Structure of an application entity for image transfers using two SAOs

3.3 Services for image transfers

-Basic transfer service: This service entails a phase of negotiation about the representation of the data and a phase of actual transfer. The negotiation phase has to insure that the data received are matched to the receiver, which should be able to display without modification the data on its screen. The transfer phase uses the service furnished by FTAM to the degree that images are represented as data of the same nature as a file.

-Progressive transfer service: This service enables us to transfer images with lower resolution (1 pixel in 4, for example) with the goal of more rapid transfer or with the goal of scanning or leafing through a group of images.

-Selective transfer service: This service enables us to select a portion of an image.

-Compression service: Since pixels of an image have either spatial or temporal correlations, we can exploit appropriate kinds of compression. The techniques that we have adopted are DCT (Discrete Cosine Transformation) [EUD 86] and ADPCM (Adaptative and Differential Pulse-Code Modulation, or MICDA: Modulation par Impulsion et Codage Différentiel et Adaptatif) both within and between images [LAB 87].

-Broadcast service: This service allows us to transmit images from a sender to several receivers.

-Detection service: This service facilitates recovery from losses, duplications, errors, etc.

3.4 Steps in image transfer

The first step consists of choosing the service mode (connected or unconnected) and the remote correspondent with the primitive ITAM-ESTABLISH. The phase of negotiation, called ITAM-

NEGOTIATE, sets the transfer parameters as a function of resources and terminals. The virtual terminal service VT is used. The request to open the data association is handled by the primitive ITAM-OPEN. The user has the option to specify a compression technique by ITAM-COMPRESS.

After these first steps, the actual transfer is requested by ITAM-PLAY. This service decomposes the image into units of data, and then the transfer is managed by FTAM. Interruption and/or termination of the transfer are handled by a group of primitives: ITAM-END, ITAM-STOP, ITAM-ABORT.

3.5 Image transfer protocol

Starting from these services, we can specify the protocol by using a formal description technique, ESTELLE [EST 89]. The exterior step is the writing of a model of this protocol in a language executable on a given operating system.

4. PROTOCOLS AND TECHNIQUES FOR HIGH SPEED IMAGE TRANSMISSION [COU 90b]

4.1 Image characteristics

Images have some temporal constraints that do not exist in the data conventionally handled in data processing. In order to express these temporal constraints, we have to distinguish the time interval $T(i,j)$, which separates two signals i and j , from $T(0,j)$, the time interval separating the signal j from the origin.

The first constraint for us is that the delay in the broadcast of a film has to be humanly acceptable. If we denote the waiting time for the first image as T_{max} , and the reception time as T_r , and the time of broadcast as T_e , then we have the following relation:

$$(1) \quad \forall i \quad T_r(0,i) < T_{max} + T_e(0,i).$$

The second constraint turns on the fact that images must appear on reception at the same speed as at the sender. Accordingly, we have the following relation:

$$(2) \quad \forall i,j \quad T_r(i,j) = T_e(i,j).$$

4.2 Synchronous and asynchronous transmissions

During a broadcast, the clock of the image receiver is slaved to the clock of the sender by means of synchronization signals included in the image during its transmission.

With the synchronous technique, the intervals of time are preserved during transport. Synchronization between the receiver and the sender is thus easily maintained; only a constant delay is added, this delay is due to the time required for transfer.

In the case of an asynchronous transmission, the delay varies, according to the load and the method of access. In such a case, it is no longer possible to slave the receiver's clock to the received signal.

In this case, one can reconstitute the missing temporal information locally by means of specific delimiters inserted explicitly in the signal during transmission.

Deviation of the receiver's clock away from that of the sender is inevitable due to the fact of the possible long duration of broadcasts and due to the high frequencies used.

A buffer of units of transmission can accommodate variations in the local clock. A reasonable size for such a buffer is fewer than 30 bytes.

The technique for correcting the clock drift by suppression or insertion of periods of recalculation necessitates the storage in memory of a complete image at the level of the receiver in order to be able to regenerate the image if necessary, and in order to absorb the variations in speed of transmission.

4.3 The FDDI protocol (Fiber Data Distributed Interface) [FDD 87]

The standard of the FDDI protocol (proposed for transmissions at 100 Mbits/s) stipulates both synchronous and asynchronous modes of transmission.

The synchronous mode insures that a station has a pre-allocated bandwidth and the right to transmit at an average period of time equal to a value negotiated among all stations on the network. This negotiated interval is called the Target Token Rotation Time (TTRT). Moreover, the protocol guarantees that the maximum transmission time will not exceed two times the TTRT (2TTRT).

The TTRT should lie between two values: T_{min} (minimum time required for the management and rotation of the token) and T_{max} (maximum time that the stations may keep the token and still allow fair access to the network).

Once the TTRT is fixed, knowing the average throughput d_i required by each station i to transmit images in real time, we should limit the number of bits sent by each station on each turn with the token in order to sustain this relation: $\sum d_i \leq D$ where D represents the effective throughput of the medium. We must respect this relation in order to avoid overloading the medium.

The synchronous mode of transmission is proposed for the transmission of film images. The application should be aware of the average throughput d_i necessary to the transmission of a film; in addition, it should request (from the network manager) a reservation for the duration of the film transmission. During the process of negotiation, we find that the smaller the TTRT, the shorter is the transmission time, and thus the fewer or shorter the delays due to transmission. But in this case, the efficiency of FDDI is accordingly diminished as well.

Careful calculations indicate that the ideal value lies in the neighborhood of twenty milliseconds. An application should have the right to send up to $l_i = d_i \times \text{TTRT}$ bits at each turn with the token.

Accordingly, at the price of a slight delay equal to the TTRT due to the image buffering at the level of the image receiver, it is useless to get a token rotation time equal to half the rotation time required, as that leads to a guaranteed maximum transmission time of two times the TTRT.

4.4 Asynchronous Transmission Mode (ATM)

The technique of asynchronous transmission facilitates communication on a very high speed network. It uses a technique between packet switching and circuit switching. As in the technique of packet switching, the frames contain a block of data and an address; as in the technique of circuit switching, there is no control of errors nor of flow. Since the size of the frames is fixed, the mechanisms for switching are very simple, and the switching equipment achieves very high throughput. These two switching techniques give rise to four distinct phenomena:

- the absence of control procedures implies that the rate of error is the inherent rate of the medium;

- the absence of flow control may bring about congestion at the level of the switches. But global control can manage the resources to avoid overallocation;

-at each switch, the waiting queues for frames can add to the transmission delay. The use of small-sized frames can resolve this problem;

-the asynchronous transmission technique introduces the phenomenon of variable delay which can disturb the transmission of synchronous data.

Statistical considerations show that in most cases, these inconveniences are not noticeable. [BOY 87]

4.5 Comparison

These two techniques--FDDI and ATM--both offer the same solutions to transmission synchronization and to minimization of delays induced by intermediate equipment and access methods.

FDDI has the advantage of controlling access to the medium by offering both synchronous and asynchronous modes.

With ATM, it is possible to pre-allocate a certain number of cells to convey samples of movie, but it is not possible to avoid occasional loss because of congestion of the network at the level of ATM switches. This latter case being a rare state, the ATM technique can, nevertheless, be utilized.

A study simulating the behavior of these methods is currently underway.

5. ELECTRONIC ARCHITECTURE OF THE DIGITIZED IMAGE COMMUNICATION SYSTEM [KAM 90c]

Current communication networks tend toward progressive growth in their capacity for information: we have observed the natural progress from networks of 10 Mbits/s, to those of 100 Mbits/s, to prototypes of 1 Gbit/s.

In general, communication systems and, in particular, high speed local area networks (HSLANs) for image transfer consist of five basic components: physical support; protocols; communication controllers; host computer and image system.

Specific characteristics of HSLANs require adaptations in each of these five components. Progress in the design of optical components has enabled us to tackle problems posed by bandwidth and distance. Yet the debate is still open when we start talking about HSLAN protocols and controllers characterized by very high throughput and very short response time.

In a conventional architecture representing these five components, the system of acquisition and visualization of images is connected to a host computer and all transfer of image data passes by the bus of that host.

The communication controller handles the data transfer between the network and the host computer according to specific rules of the protocols.

This conventional configuration presents some inconveniences which limit effective throughput of data transfers on the network, and it necessitates the following improvements:

a. In order to unload the host, the communication controller should execute communication software as autonomously as possible. Most the entities of the layers in the OSI reference model should be implemented in the controller. Protocols should be adapted accordingly and should respond to demands of ultra-rapid exchanges.

b. The connection between the image system and the host constitutes a handicap as far as increasing throughput; likewise the bus of the host can be a bottleneck, too. Effective throughput of data transmission on the network (several gigabits per second) is nevertheless very much greater than the throughput of information on conventional busses within computers, which are only on the order of 40 Mbits/s, or in the most recent generation of rapid processors, as much as 300 Mbits/s. The data transfer system should adapt to this ratio in throughput by using a parallel architecture owing to a multi-port memory.

An original approach would be to connect the image system directly to the communication controller and to overcome a part of the bottleneck of the host bus. Yet in the case of image treatment in the host, the bus has to be a part of the path that data follow, but the constraints on the throughput are less severe because the image treatment need not be a real time application in such cases. An ideal configuration, therefore, is pictured in Figure 6, where the protocols are executed in the controller, and where the image system is directly connected to the communication controller.

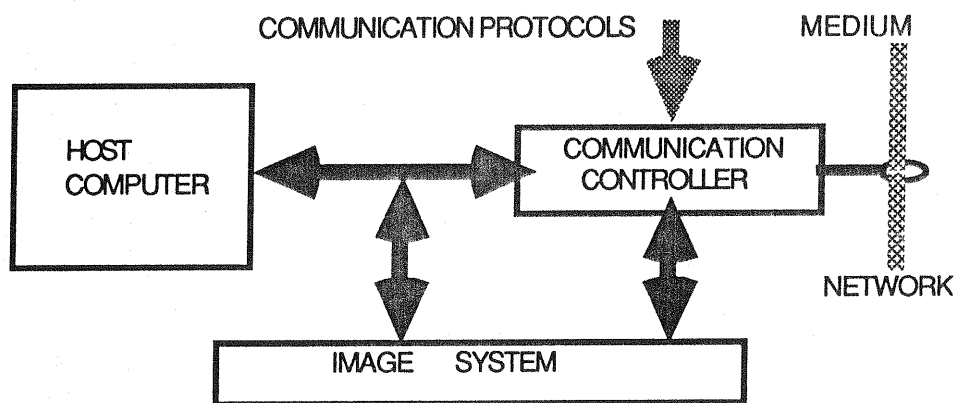

Figure 6: Ideal configuration of an image communication system

6. TECHNIQUES FOR VALIDATING PROTOCOLS

6.1 Principles

The validation phase consists in verifying that the behavior of the formal model has neither dysfunctions nor anomalies. In our study, we were interested in an exhaustive validation. We produce all global states of communication, and we verify that there is no blocking errors such as deadlock states, unspecified reception, and blocking loops.

To carry out this verification, each protocol entity is modelised by a finite state machine (FSM):

FSM = (S, so, I, O, V, T) where

- S is the finite set of states;
- so the initial state;
- I the finite set of input events;
- O the finite set of output events;
- V the finite set of integer variables;
- T the set of transitions $I \times S \times P \rightarrow O \times S \times A$;
- P the predicates on V and the integer constants;
- A the actions.

A transition $t = (i, s, p, o, s', a)$ is executed when the event i occurs in the state s while the predicate p is true. When transition t is fired, the following state is s' , the action a is executed, and the output event o is sent out.

The local entities communicate by exchanging messages throughout FIFO channels as pictured in Figure 7

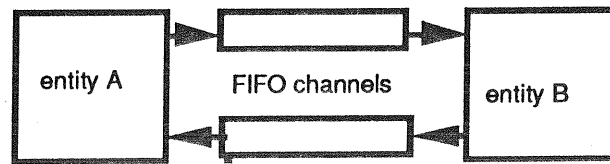

Figure 7: Communication model

The method used [ZAF 80] presupposes the construction of the accessibility graph containing all the global states of the communication.

A global state is represented by the current state of each entity, the contents of the channels, and the values of the variables. It can be represented as in Figure 8.

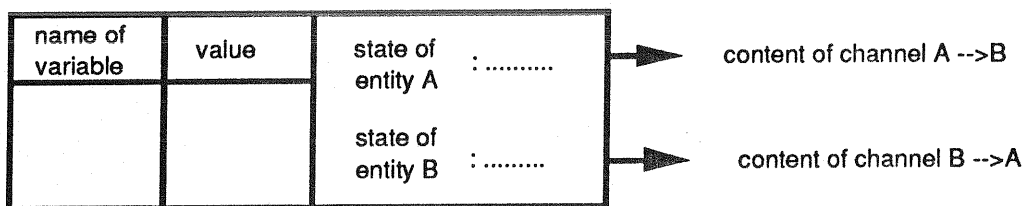

Figure 8: Implementation of a global state

VAP software has been developed to permit the automatic handling of the validation of a protocol where the size of the accessibility graph ranges as high as 50 000 states. It is clear that this method essentially validates the control aspect of the protocol and not the graph of the data.

6.2 Help in correcting anomalies [VIH 90]

The model of a protocol, represented in terms of FSM, can present certain anomalies, such as deadlock, blocking unspecified reception, and so forth.

In order to correct the protocol, it is necessary either to modify, either to add, either to suppress one or more transitions in the protocol entities. The greatest difficulty facing automatic correction remains the need to preserve the semantics and the general behavior of the protocol.

At first, we were interested in an algorithm for suppression. The basic principle is the suppression of any transition which belongs to all the paths leading to the anomaly, starting from the global initial state. This suppression should eliminate the least number of global states from the accessibility graph, among which the anomalous state, while respecting a non-regression propriety (that is to say, without generating any new errors).

Toward this end, we construct a tree, called the tree of elementary communication sequences, representing all the paths of communication between the protocol entities. We distinguish two types of nodes: those which permit the return to the initial global state and those corresponding to anomalous state. We suppress any transition for which the source node makes it a node without a successor. We also suppress those transitions representing the unique occurrence of sending (or of reception) a message and for which the suppression of corresponding transitions of receiving (or sending) creates nodes without successors in the other machine. The transitions are ordered in a way to minimize the number of global states suppressed in the accessibility graph. See [VIH 90] for the details of this algorithm. We have exercised the algorithm on the X25 protocol with an accessibility graph of about 37000 states.

7. TESTS FOR CONFORMITY AND INTEROPERABILITY

7.1 Introduction to protocol tests

The general goal of the OSI model [ISO 84] is to make distant and heterogeneous systems interoperable. The first step in achieving interoperability of implemented protocols is testing their conformity. We verify that the protocol reacts in conformity to the norm. The OSI has proposed a methodology to this effect in a multi-part standard [ISO 96]. Even if the conformity of protocols has been verified, we cannot be certain of their interoperability, but conformity greatly increases the probability of their interoperability. A great deal of work has gone into designs, methods, and tools for testing conformity. A general overview can be found in [SAR 89]. Since industry has more at stake with regard to interoperability, industry hopes to profit from all this research already undertaken in conformity testing. [COS 89] outlines the problems posed by interoperability and indicates a way to set out to try to overcome them. Since our research group has worked for more than eight years on conformity testing, we present principal results as well as the evolution that we propose for extending these methods to interoperability.

7.2 Architecture and conformity testing

The ISO standard 9646 [ISO 96] details a certain number of methods for testing a protocol entity: local method with two points of observation; distributed method with a point of observation above the entity to be tested; distant method without a direct point of observation.

An original architecture for astride testing is offered in Figure 9 for implementing a conformity test.

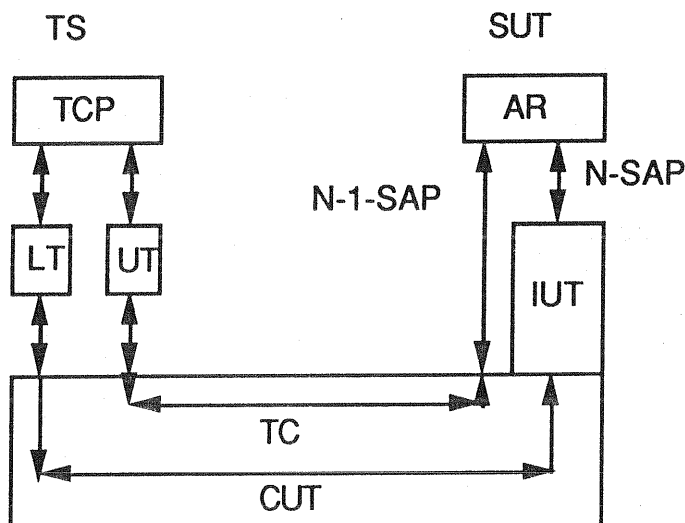

Figure 9: Architecture of astride testing

The term astride is used to indicate that the responder AR is set up on two levels of communication. This architecture uses two connections: one permitting the connection from the responder to the tester TC, and the other from the tester to the entity to be tested CUT. This architecture, as much as it appears to be derived from the distributed method, is close to the local method, that is to say, the most powerful for testing. The advantages of this architecture are the following:

- the testers UT and LT are placed in the same system TS, which facilitates procedures for coordination between the two;
- the tests can be implemented equally well starting from the test system as starting from the system to be tested;

-the astride responder is quite simple and can be reduced to a few dozen instructions for packing and unpacking primitives.

Other work on the international scene, such as "loop-back ferry" [ZEN 88], have been defined and offer similar advantages.

A system of automatic testing has been defined and set up. This system interprets a set of commands describing the implementation of test sequences in a language derived from SDL [SDL 87]. It runs on French hardware from Bull and allows testing of the transport and session layers of an entire line of hardware from this company.

7.3 Automatic generation of test sequences

Given a test architecture, we must submit it to test sequences. These test sequences should be written by specialists who know perfectly the protocol since the sequences have to cover all the usual cases of communication as well as primary functions. Methods for normalizing a given sequence are under study.

In Bordeaux, we have undertaken research to generate test sequences automatically, starting from their specification in terms of FSM.

We can distinguish two classes of algorithms:

- a touring method which exercises every transition [NAI 81]; from it, we obtain a sequence containing at least one instance of every transition of the FSM;
- a method using FSM with particular properties. GAST software [GUI 84] to generate such FSM is based on the methods presented in [BOC 83] and has already been greatly extended from there, starting from work on the UIO methods of sequences [VUO 89].

The preferred output is couched in the OSI language TTCN [ISO 96]. This output is obtained automatically by including the transformations taking into account the service on the lower layer used to implement the test [CAS 86].

7.4 Interoperability testing [RAF 90]

The technique of astride testing has been extended to facilitate interoperability testing. This extension demonstrates clearly the great generality of this testing technique, its power of adaptation, and its capacity for evolution. Figure 10 shows the proposed architecture.

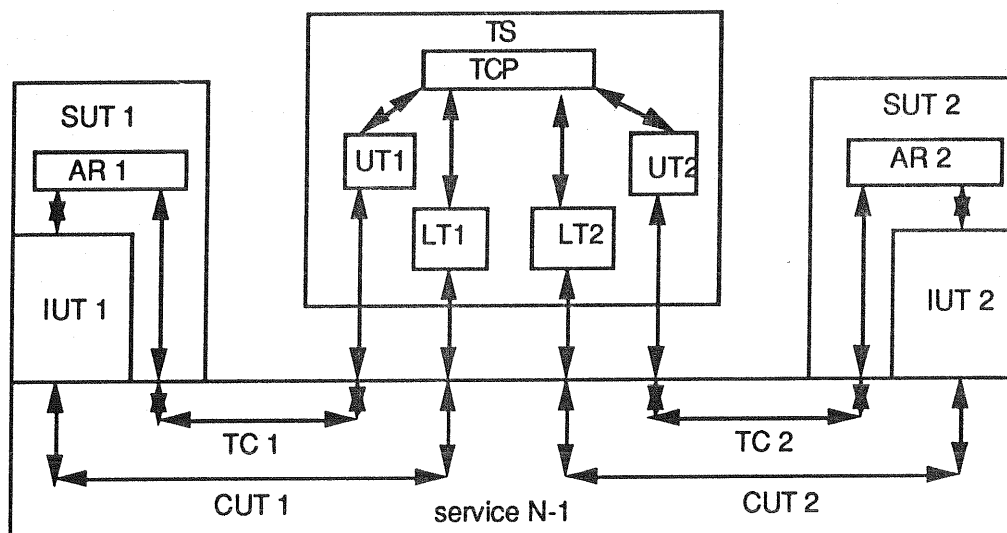

Figure 10: Architecture for interoperability astride testing

In this architecture, when we want to test the interoperability of two systems SUT1 and SUT2. We place the test system TS between them. The test system TS must manage two groups of test units, UT and LT, the one associated with one of the systems to test (namely, SUT1), and the other, obviously associated with SUT2, the other system to test. [RAF 90] suggests a new methodology for the generation of test sequences. It consists of traversing the global communication accessibility graph of the two entities being tested for their interoperability.

8. CONCLUSION

All the steps leading from the initial design of a service and a protocol and going through the final tests for conformity and interoperability have been presented here in the context of image transfer. The techniques suggested are both simple and highly generalizable. They represent the fruit of several years of research and, in the majority of cases, have actually produced working, industrial implementations, showing clearly their practicality and adaptability. They obviously constitute part of the international research scene into the field of communication protocols. Indeed, they can be extended to other domains with few or no problems.

9. REFERENCES

- [AYA89] A. AYACHE, R. CASTANET . Management of a video transmission network Network Information Processing Systems, SOFIA Bulgarie, May 1988, North Holland.
- [BOC83] G.V. BOCHMANN, B. SARIKAYA. Some experiences with test sequence generation for protocols, IFIP WG6.1 3rd international workshop on protocol specification, testing and verification, Zurich, May 1983
- [BOY87] P. BOYER, J. BOYER, J.R. LOUVION, L. ROMOEUF, Modelling the ATD transfer technique ,Traffic Engineering for ISDN, COMO 1987.
- [CAS86] R. CASTANET, R. SIJELMASSI. Methods and Semi-automatic Tools for Preparing Distributed Testing, 6th IFIP Workshop on Protocol Specification, Testing and Verification , Montréal, Gray Rocks, Sept 1986.
- [CAS90] R. CASTANET, X. NAVARRO. ITAM, un Service de Transmission d'Images Numériques. Premier colloque international sur les chaines professionnelles de l'image. IMAGECOM 90, 19-21 November 1990, Bordeaux-FRANCE.
- [COU87] J.P. COUDREUSE, P.GONNET. Techniques temporelles asynchrones ATD: éléments de synthèse in Proc. Forum Télécom, Genève 1987.
- [COS89] J. GADRE, C. ROHRER, C. SUMMERS, S. SYMINGTON. A COS Study of ISO Interoperability, Computer Standards and Interfaces, 9. 1989, pp 217-237.
- [COU90a] B. COUSIN, L. KAMOUN. Study and evaluation of local area network architecture for video image transmission. INDOLAN 90, International conferences on Local Area Network. January 30&31 1990, Madras-INDIA.
- [COU90b] B. COUSIN, R. CASTANET, L. KAMOUN. ATM, HSLAN and Images, Multimedia, Bordeaux, Nov. 1990.
- [DIC87] G. DICENET. Le RNIS, Techniques et Atouts . Masson 1988.
- [EST89] Estelle: The Formal Description Technique ESTELLE, Edited by M. Diaz, J.P. Ansart, J.P. Courtiat, P. Azema, V. Chari, North Holland 1989.
- [EUD86] G. EUDE, J. GUICHARD. Codage intra-trame par transformée en cosinus, 2ième colloque image, Nice 1988.
- [FDD87] FDDI Token Ring Media Access Control , ANSI X3.139, 1987.
- [GUI84] P. GUITTON. Description, Validation, et Test de Conformité de Protocoles de Communication, Thèse de l' Université de Bordeaux I, Jan. 1984.
- [ISO87] Metafile for the storage and transfer of picture description information, ISO/IS 8632, 1987
- [ISO95] Open Systems Interconnection. Application layer Structure. ISO/DIS 9545, 1988
- [ISO96] ISO, Information Processing Systems, OSI Conformance Testing Methodology and Framework, Parts 1,2,3,4,5 ISO 9646.

- [KAM88] L.KAMOUN, H.HENRY, A.MORA. Local area network for video image transmission. Proceedings of the international conferences on Data Communication Technology, 21-23 Sept 1988, NIHE, Limerick, IRLANDE.
- [KAM89] L.KAMOUN, H.HENRY, A.MORA. Réseau de vidéocommunication RETINE. 10ème Journées Tunisienne d'Automatique et d'Electrotechnique (JTAE) Décembre 1989, Hammamet-TUNISIE.
- [KAM90a] L. KAMOUN, A. AYACHE, R. CASTANET, H. HENRY, A. MORA et R. DUCASSE. Un exemple de réseau local de vidéocommunication, L'ONDE ELECTRIQUE, Janv.90, Vol 70, n°1.
- [KAM90b] L. KAMOUN, B. COUSIN, H. HENRY, A. MORA. Implementation technique for videocommunication LANs. Workshop MULTIMEDIA 90, 15-17 November 1990, Bordeaux-FRANCE.
- [KAM90c] L. KAMOUN, H. HENRY, A. MORA. Réseau local de transmission d'images numérisées. Premier colloque international sur les chaines professionnelles de l'image. IMAGECOM 90, 19-21 November 1990, Bordeaux-FRANCE.
- [LAB87] G. LABIT. Séquences d'images et techniques de codage MICDA intra/inter image, Rapport de recherche INRIA n° 630, Fév. 87
- [NAI87] S. NAITO, M. TSUNOYAMA. Fault Detection for Sequential Machines by Transition Tour. IEEE Fault Tolerant Computing Conference, p. 338-343, 1981.
- [RAF85] O. RAFIQ, R. CASTANET, J.P. GOURSAUD, J. HADDAD, X. PERDU. Towards an Environment for Testing OSI Protocols, IFIP Workshop on Protocol Specification, Verification and Testing, Toulouse 1987, North Holland.
- [RAF90] O. RAFIQ, R. CASTANET. From Conformance testing to interoperability testing Workshop on Protocol Test Systems, Washington, USA, October 90.
- [SAR89] B. SARIKAYA. Conformance Testing : Architectures and Test Sequences, Computer Networks and ISDN Systems, Vol 17(2), 1989, pp. 111-126.
- [SDL87] Recommandation Z100-Z104. CCITT SG XI, 1987.
- [VIH89] G.G. VIHO. Manuel d'Utilisation de VAP, Rapport Interne n° 8916, Laboratoire LaBRI, Université de Bordeaux I, Avril 1989.
- [VIH90] G.G. VIHO, R. CASTANET, O.RAFIQ. De l'Aide à la Correction des Anomalies dans les Protocoles de Communication, Congrès Nouvelles Architectures, Paris, Octobre 1990.
- [VUO89] S.T. VUONG, W.L. CHAN, M.R. ITO. The UIO Method for Protocol Test Sequence Generation, 2nd International Workshop on Protocol Test Systems, Berlin October 1989.
- [ZAF80] P. ZAFIROPOULO, H. WEST, H. RUDIN, D.D. COWAN, D. BRAND. Towards analysing and synthesing protocols, IEEE trans. on Communication, Vol com 28.4, April 1980, pp. 651-661
- [ZEN88] H.X. ZENG and all. Promoting the Local Test Method with the new Concept Ferry Clip, Proceedings of the 8 th IFIP on Protocol specification, Testing and Verification, Atlantic City, June 1988.