



HAL
open science

Pole vaulting of long fibres in a turbulent wall-bounded flow

Christophe Brouzet, J Bec, Christophe Henry

► **To cite this version:**

Christophe Brouzet, J Bec, Christophe Henry. Pole vaulting of long fibres in a turbulent wall-bounded flow. Complex Days, Rudy Valette; Claire Michel, Feb 2024, NICE, France. hal-04806528

HAL Id: hal-04806528

<https://hal.science/hal-04806528v1>

Submitted on 27 Nov 2024

HAL is a multi-disciplinary open access archive for the deposit and dissemination of scientific research documents, whether they are published or not. The documents may come from teaching and research institutions in France or abroad, or from public or private research centers.

L'archive ouverte pluridisciplinaire **HAL**, est destinée au dépôt et à la diffusion de documents scientifiques de niveau recherche, publiés ou non, émanant des établissements d'enseignement et de recherche français ou étrangers, des laboratoires publics ou privés.



Distributed under a Creative Commons Attribution 4.0 International License

Pole-vaulting of long fibres in a turbulent wall-bounded flow

C. Brouzet

in collaboration with J. Bec & C. Henry

Motivations

- Fibres in turbulent flows:

- environmental applications:

* plastic pollution

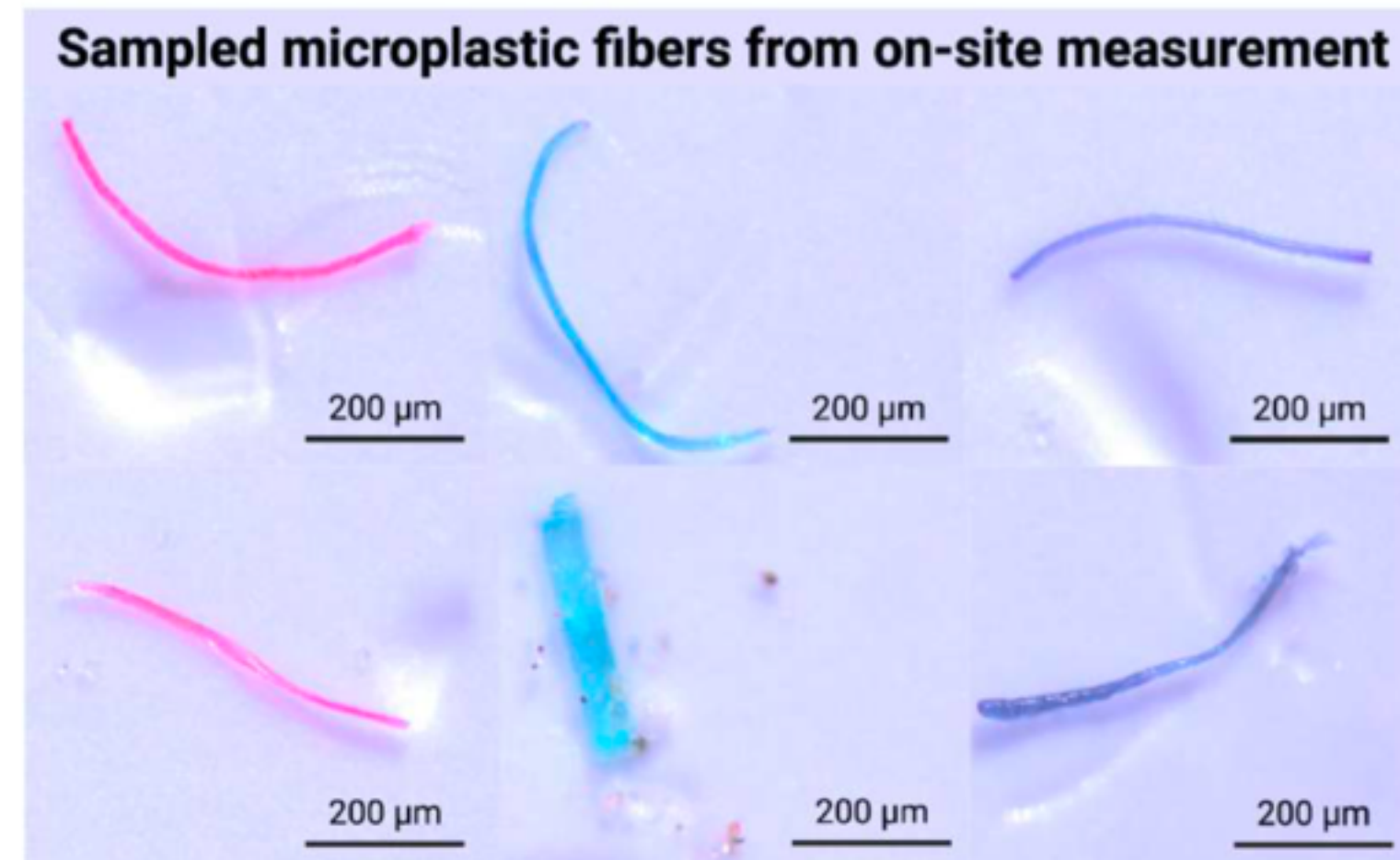

Allen *et al.* (2019)



Chubarenko *et al.* (2018)

transport ?
deposition ?
fragmentation ?

* natural fibre balls

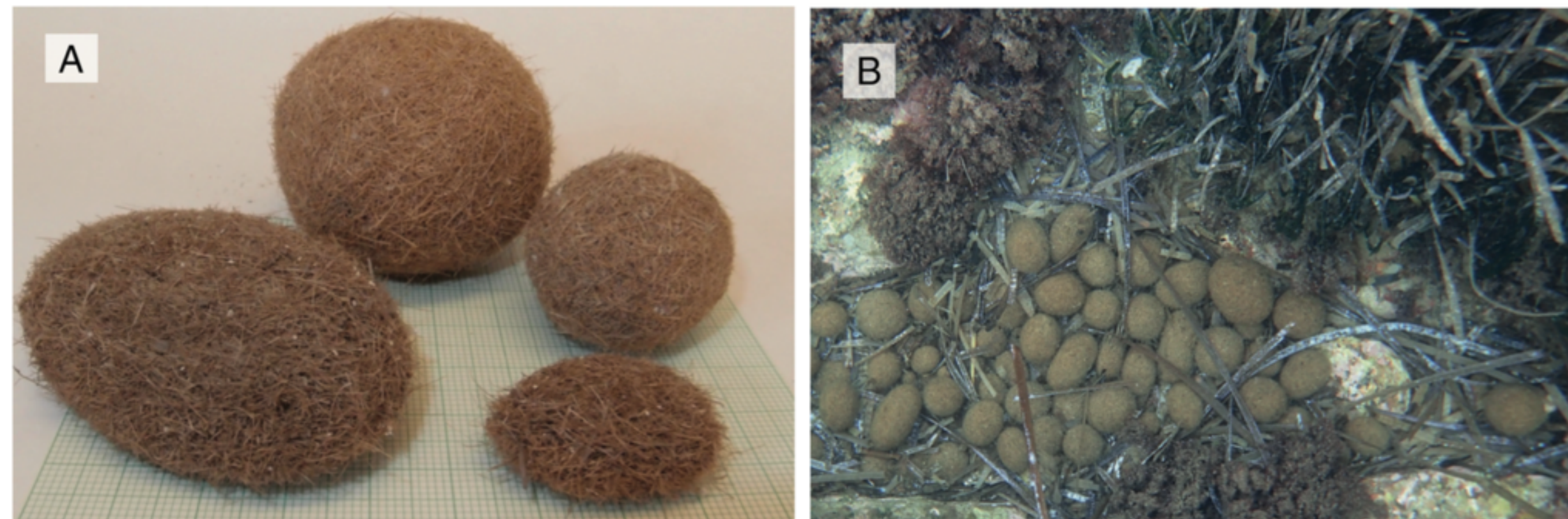

Verhille *et al.* (2017)

aggregation ?

Motivations

- Fibres in turbulent flows:

- industrial applications:

- * paper making & material fabrication

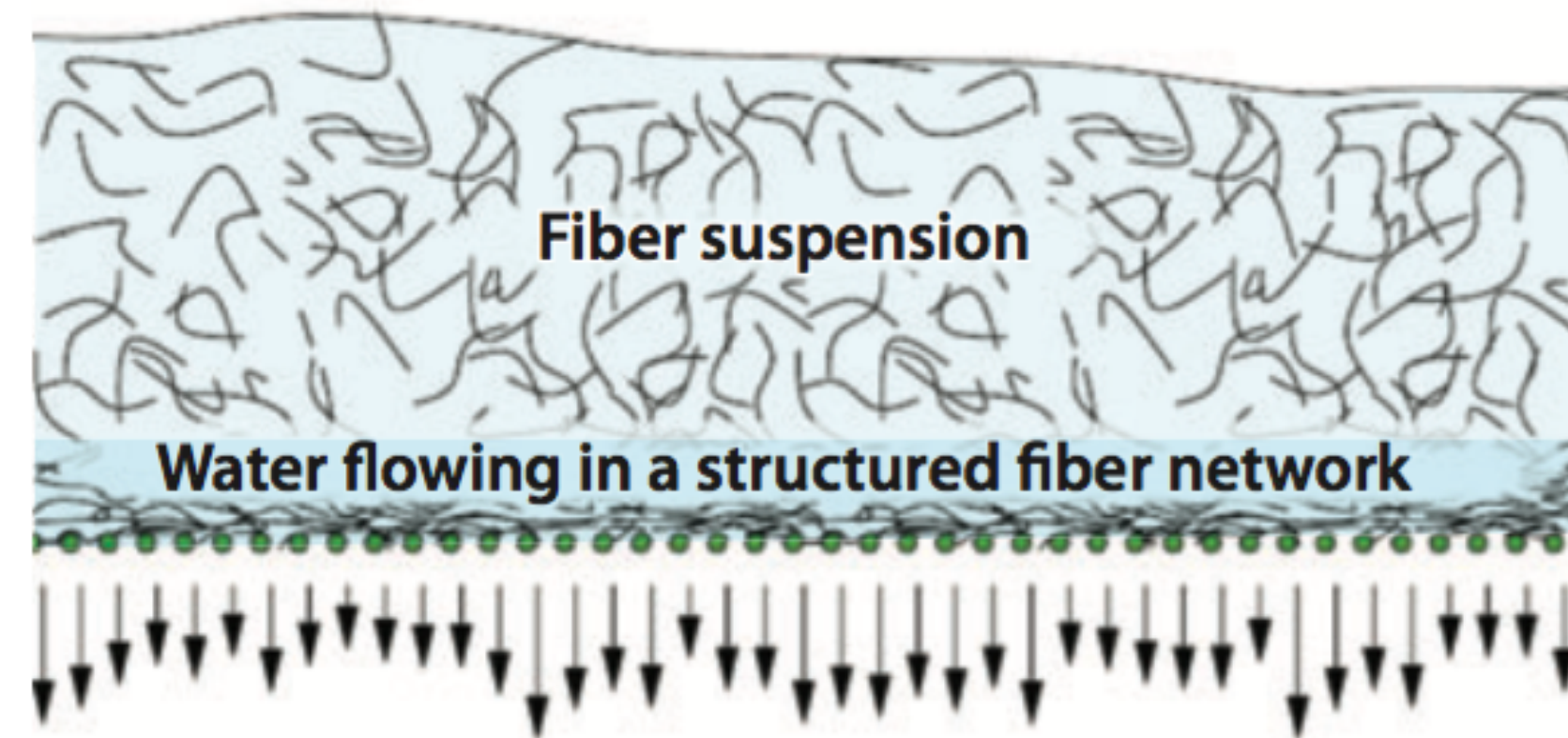

Lundell *et al.* (2011)

**orientation ?
aggregation ?**

- * water intakes



Credits: EDF



Redlinger-Pohn *et al.* (2020)

**deposition ?
clogging ?**

- Fibres in turbulent flows:
 - homogeneous & isotropic turbulence: “idealised case”
 - * rigid fibres (mainly)
 - * flexible fibres

- Fibres in turbulent flows:
 - homogeneous & isotropic turbulence: “idealised case”
 - * rigid fibres (mainly)
 - * flexible fibres
 - wall-bounded turbulent flows: inhomogeneous & anisotropic
 - * rigid & short fibres (only)

long flexible fibres in wall-bounded turbulence

=> experiments & simulations

- Fluid flow:

- open-source spectral solver *Channelflow 2.0*

- * $L_x \times L_y \times L_z = 4\pi h \times 2h \times 4\pi h/3$

- * periodic boundary conditions in x and z

- * constant bulk velocity imposed

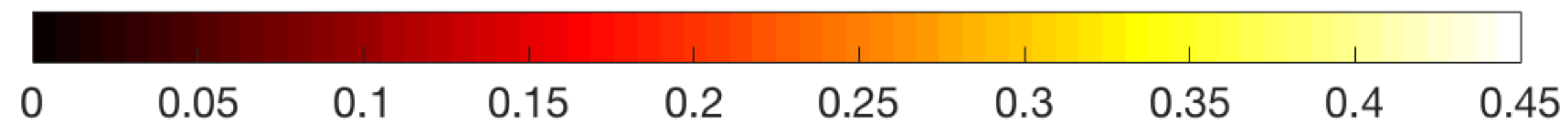

U

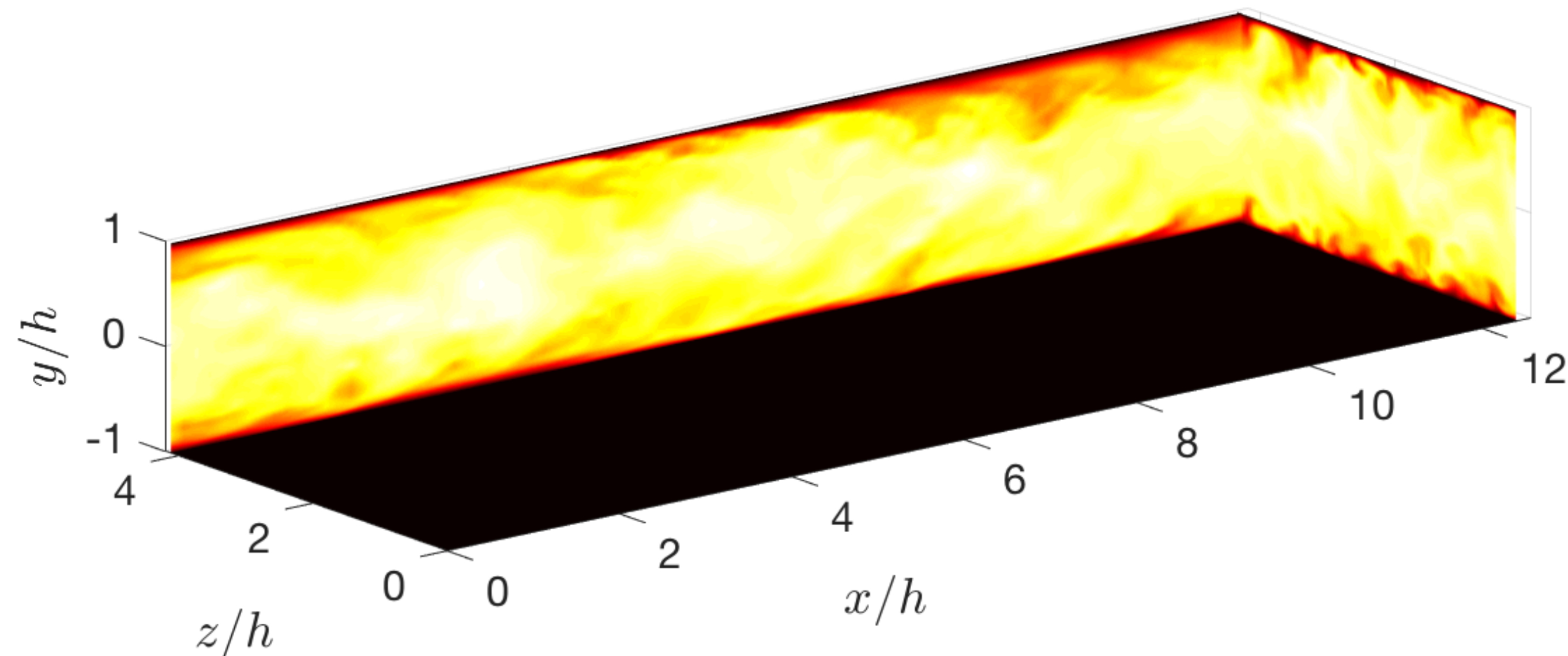

Numerical simulations

- Fluid flow:

- open-source spectral solver *Channelflow 2.0*

- * $L_x \times L_y \times L_z = 4\pi h \times 2h \times 4\pi h/3$

- * periodic boundary conditions in x and z

- * constant bulk velocity imposed

performed by Jérémie Bec

Re = 5600

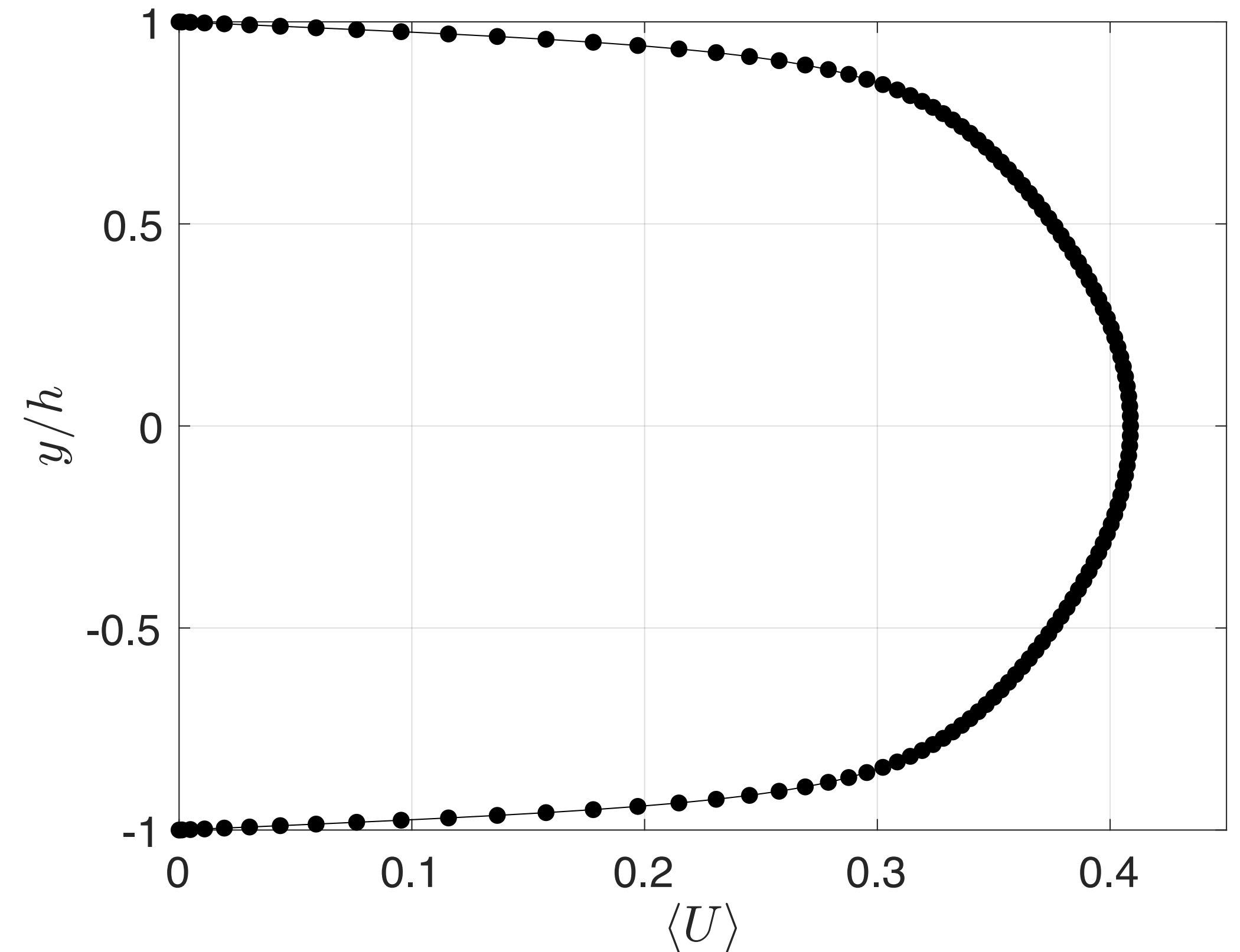
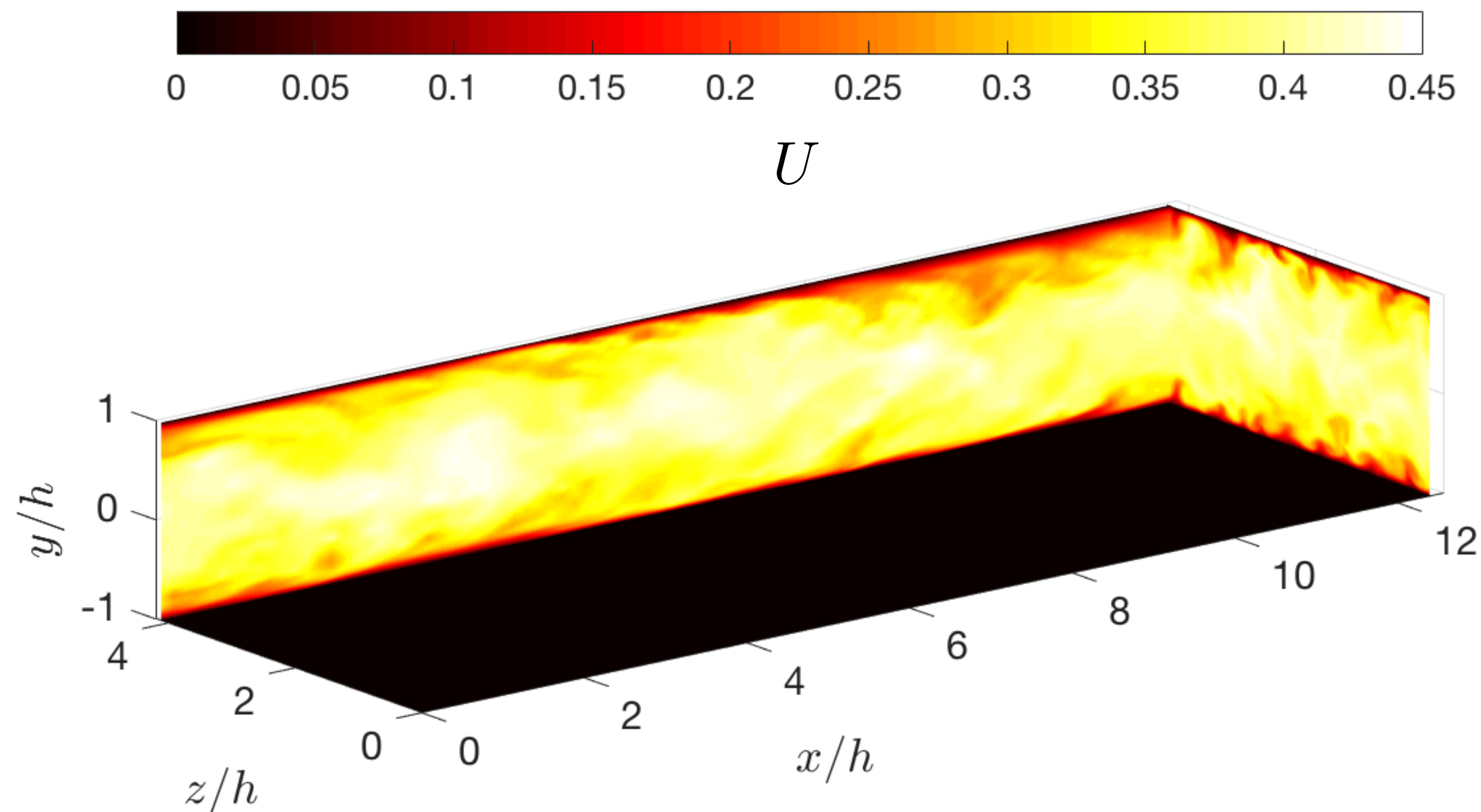

performed by Jérémie Bec

- Fluid flow:
 - open-source spectral solver *Channelflow 2.0*
 - * $L_x \times L_y \times L_z = 4\pi h \times 2h \times 4\pi h/3$
 - * periodic boundary conditions in x and z
 - * constant bulk velocity imposed
 - mean velocity profile:

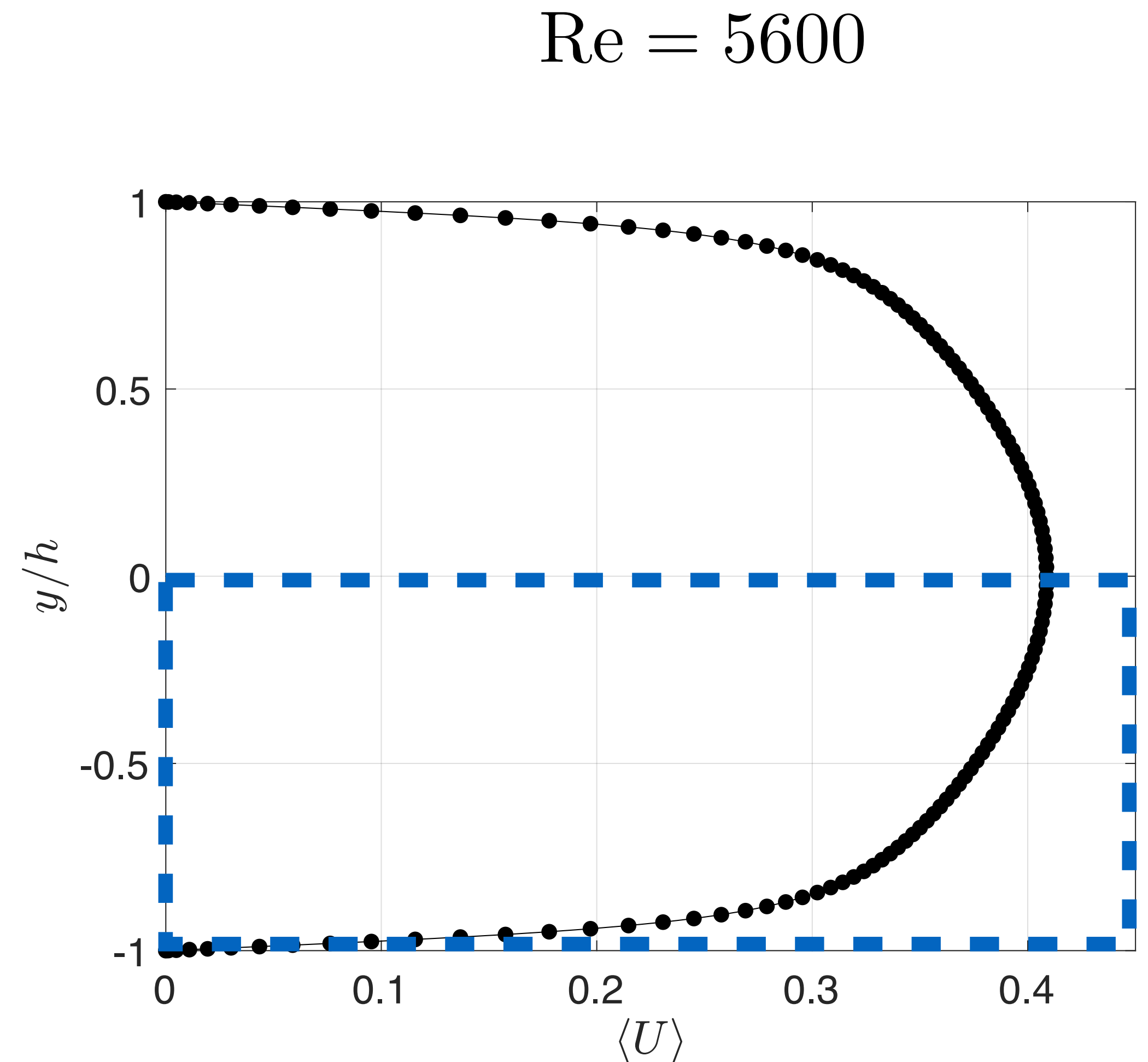

performed by Jérémie Bec

- Fluid flow:
 - open-source spectral solver *Channelflow 2.0*
 - * $L_x \times L_y \times L_z = 4\pi h \times 2h \times 4\pi h/3$
 - * periodic boundary conditions in x and z
 - * constant bulk velocity imposed
 - mean velocity profile:
 - * wall shear stress: τ_w

Re = 5600

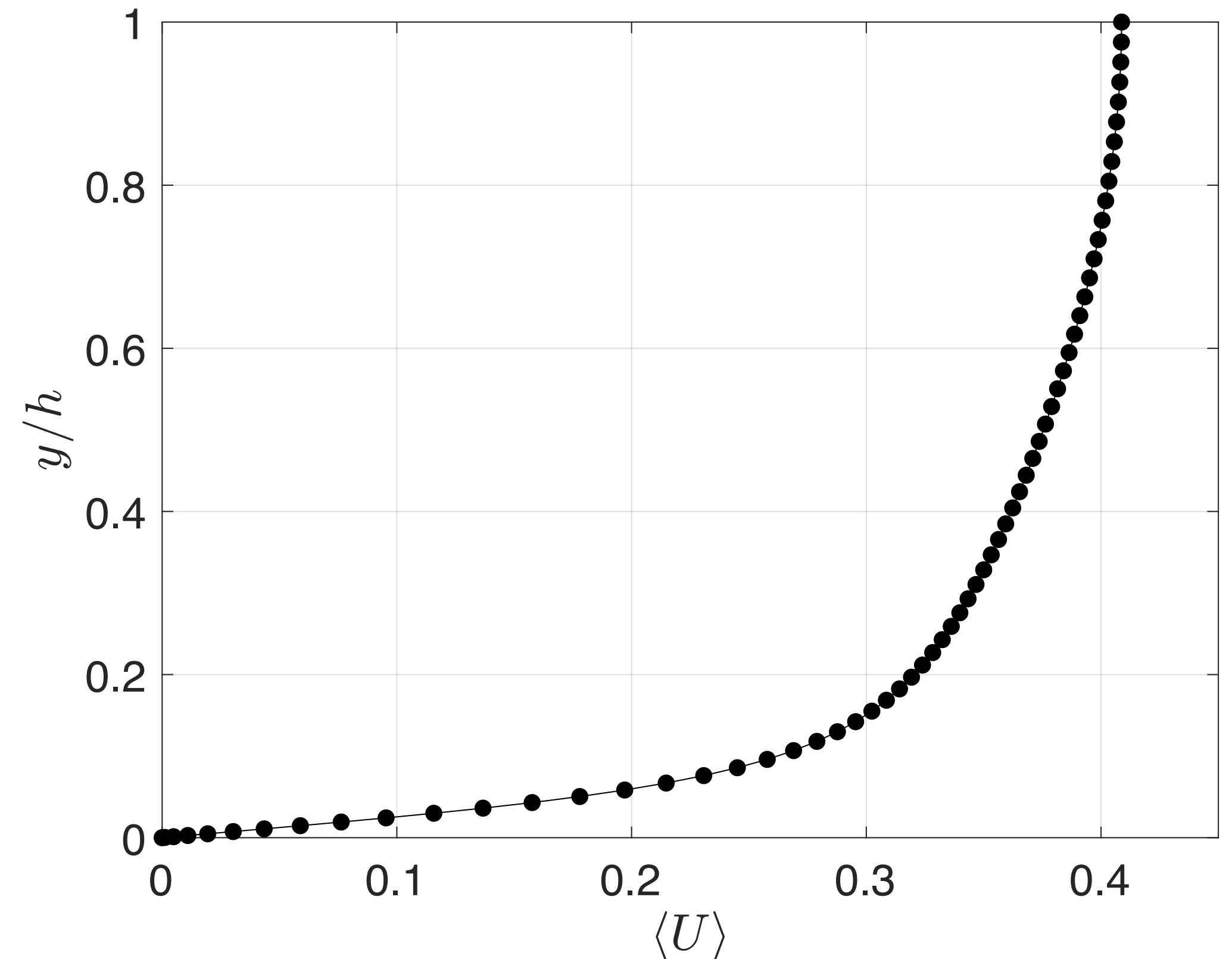

Numerical simulations

performed by Jérémie Bec

- Fluid flow:
 - open-source spectral solver *Channelflow 2.0*
 - * $L_x \times L_y \times L_z = 4\pi h \times 2h \times 4\pi h/3$
 - * periodic boundary conditions in x and z
 - * constant bulk velocity imposed
 - mean velocity profile:
 - * wall shear stress: τ_w
 - * wall units rescaling: $Re_\tau = 180$

$Re = 5600$

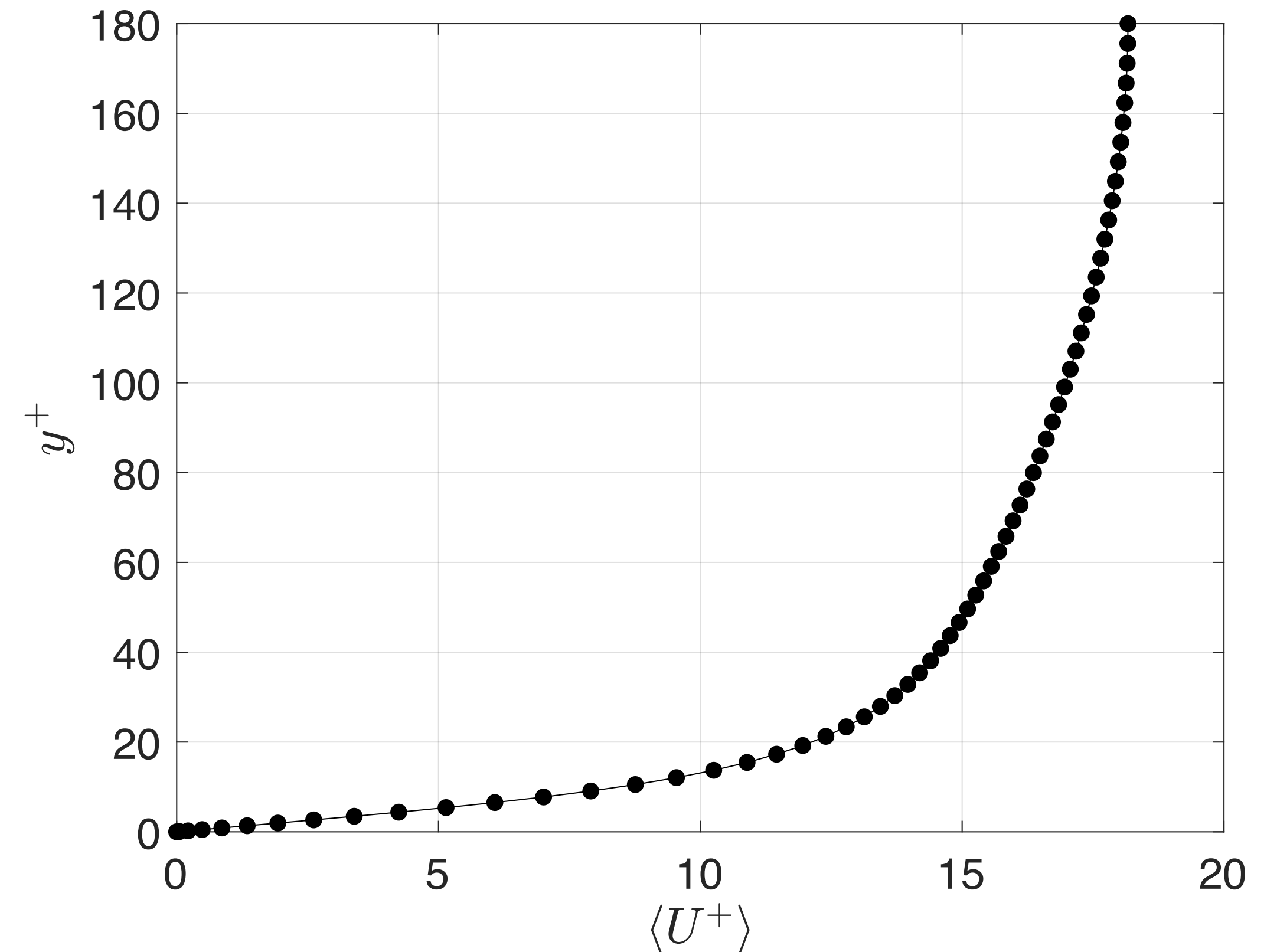

Numerical simulations

performed by Jérémie Bec

- Fluid flow:
 - open-source spectral solver *Channelflow 2.0*
 - * $L_x \times L_y \times L_z = 4\pi h \times 2h \times 4\pi h/3$
 - * periodic boundary conditions in x and z
 - * constant bulk velocity imposed
 - mean velocity profile:
 - * wall shear stress: τ_w
 - * wall units rescaling: $Re_\tau = 180$
 - * the law of the wall

$Re = 5600$

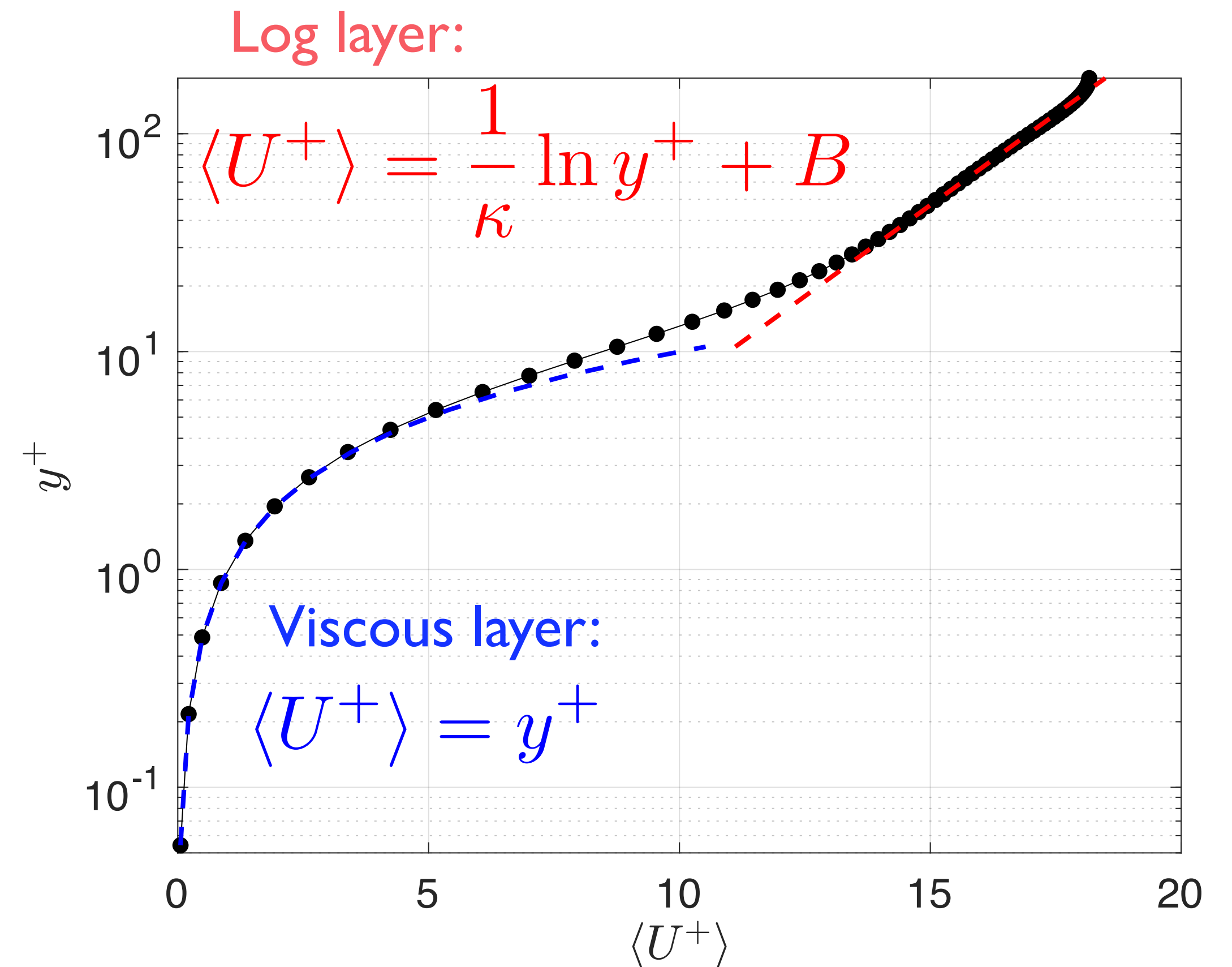

- Fibres:
 - inextensible and inertialess
 - one-way coupling

performed by Jérémie Bec

- Fibres:

- inextensible and inertialess

- one-way coupling

- over-damped slender-body theory: Cosserat equation for $\mathbf{X}(s, t)$

$$\partial_t \mathbf{X} = \mathbf{u}(\mathbf{X}, t) + \frac{c}{8\pi\eta} [\mathbb{I} + \partial_s \mathbf{X} \partial_s \mathbf{X}^\top] [\partial_s (T \partial_s \mathbf{X}) - EI \partial_s^4 \mathbf{X}]$$

with $|\partial_s \mathbf{X}|^2 = 1$

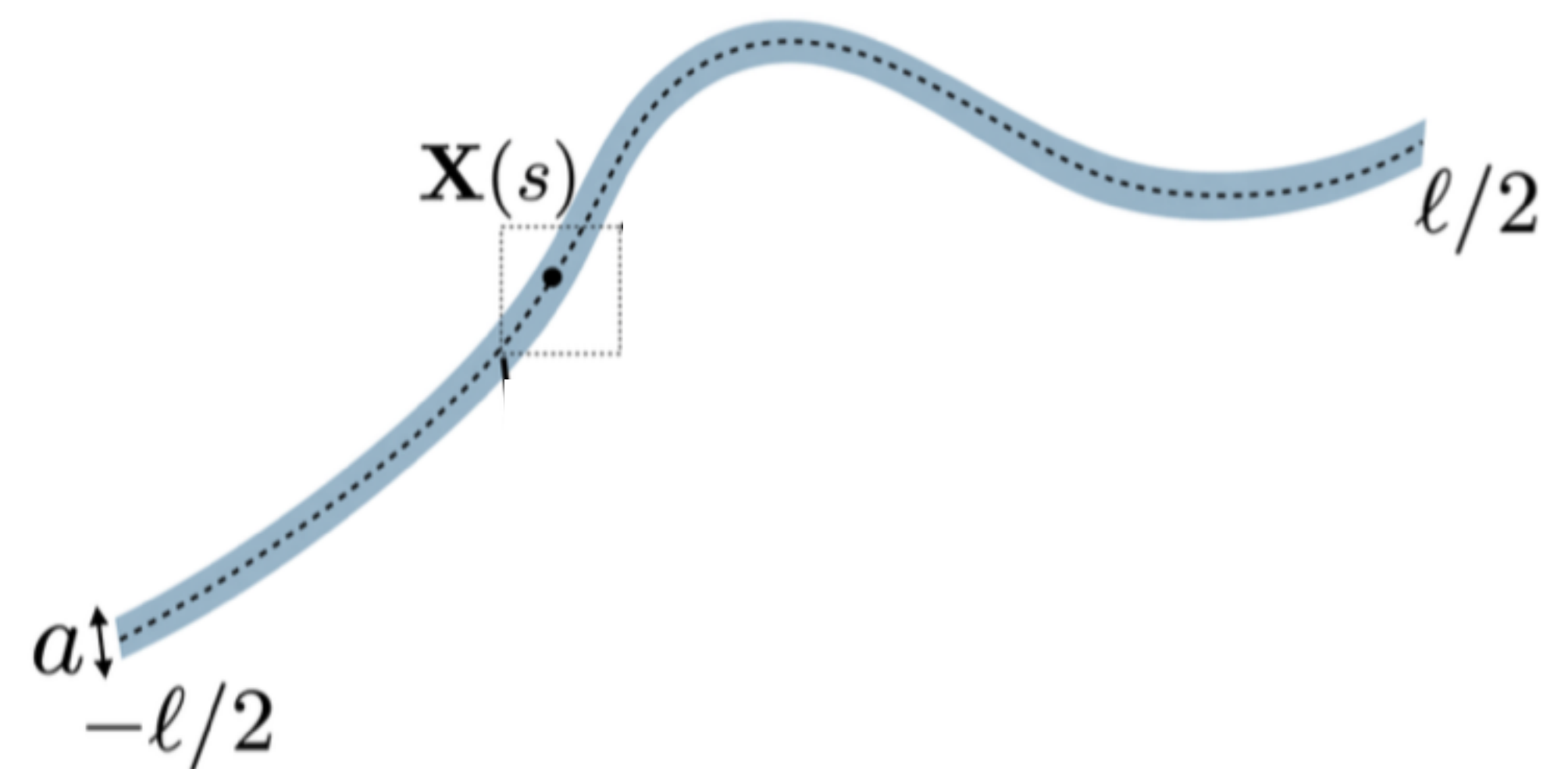

- Fibres:

- inextensible and inertialess

- one-way coupling

- over-damped slender-body theory: Cosserat equation for $\mathbf{X}(s, t)$

$$\partial_t \mathbf{X} = \mathbf{u}(\mathbf{X}, t) + \frac{c}{8\pi\eta} [\mathbb{I} + \partial_s \mathbf{X} \partial_s \mathbf{X}^\top] [\partial_s (T \partial_s \mathbf{X}) - EI \partial_s^4 \mathbf{X}]$$

with $|\partial_s \mathbf{X}|^2 = 1$

- elastic length: $\ell_E \equiv (cEI\tau_\nu / (8\pi\eta))^{1/4} \approx 7.1\delta_\nu$

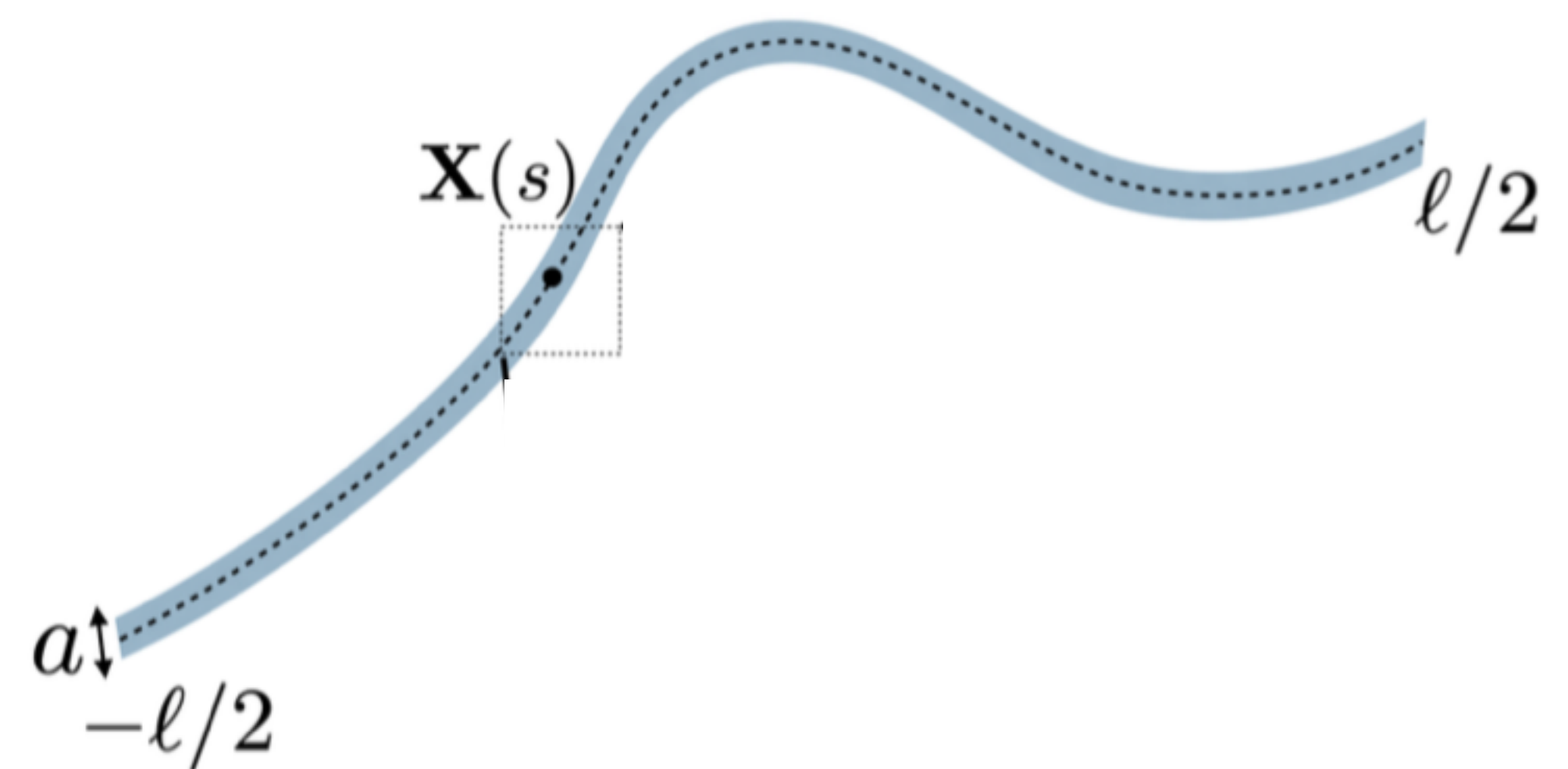

- Fibres:

- inextensible and inertialess

- one-way coupling

- over-damped slender-body theory: Cosserat equation for $\mathbf{X}(s, t)$

$$\partial_t \mathbf{X} = \mathbf{u}(\mathbf{X}, t) + \frac{c}{8\pi\eta} [\mathbb{I} + \partial_s \mathbf{X} \partial_s \mathbf{X}^\top] [\partial_s (T \partial_s \mathbf{X}) - EI \partial_s^4 \mathbf{X}]$$

with $|\partial_s \mathbf{X}|^2 = 1$

- elastic length: $\ell_E \equiv (cEI\tau_\nu / (8\pi\eta))^{1/4} \approx 7.1\delta_\nu$

- wall contact: soft boundary approach

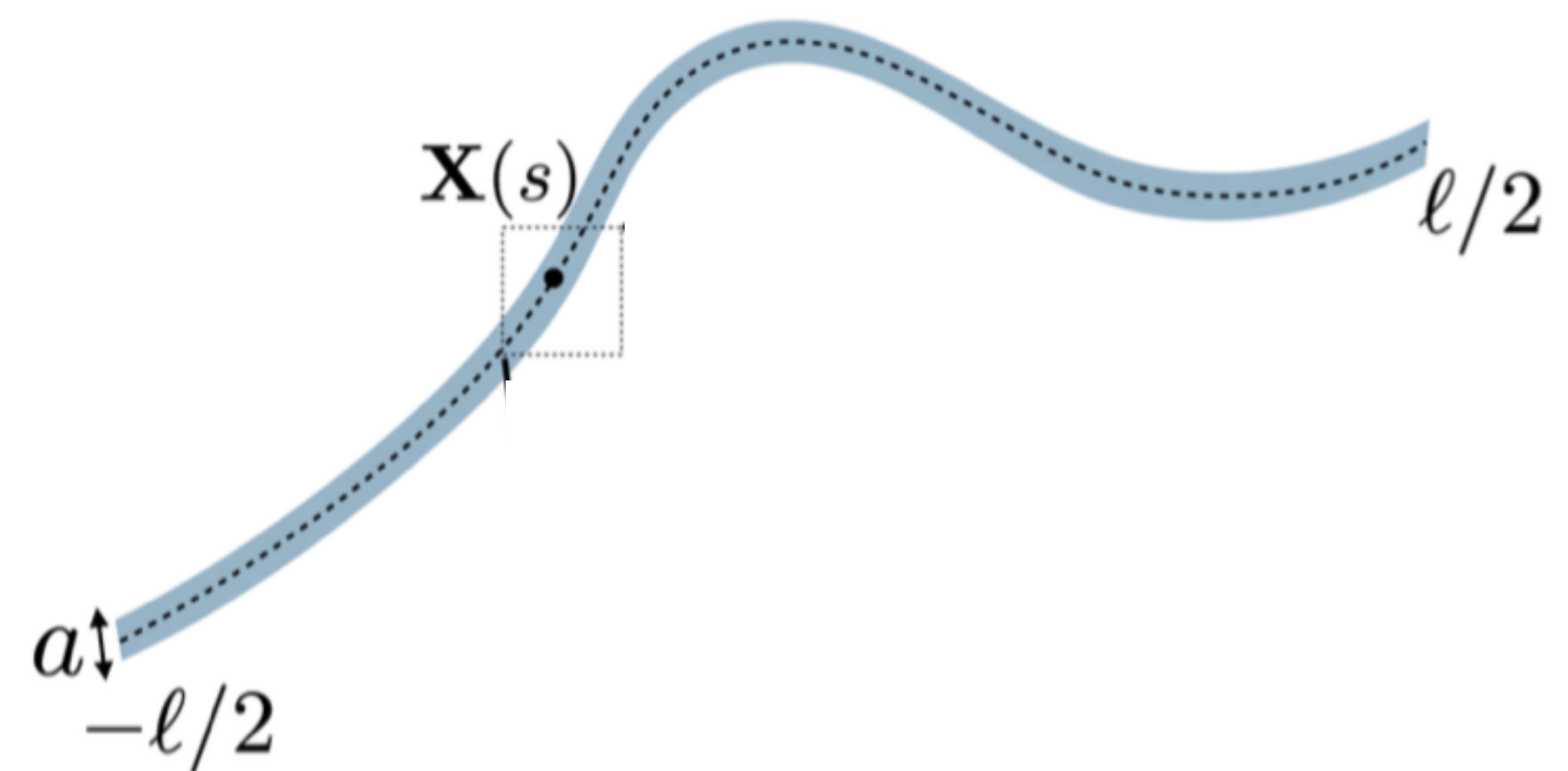

Numerical simulations

performed by Jérémie Bec

- Fibres:

- parameter space:

- * fixed elastic length: $\ell_E^+ \approx 7.1$

- * 6 different lengths: $\ell/h \in [0.08 - 1.5]$, $\ell^+ \in [15 - 270]$ + rods

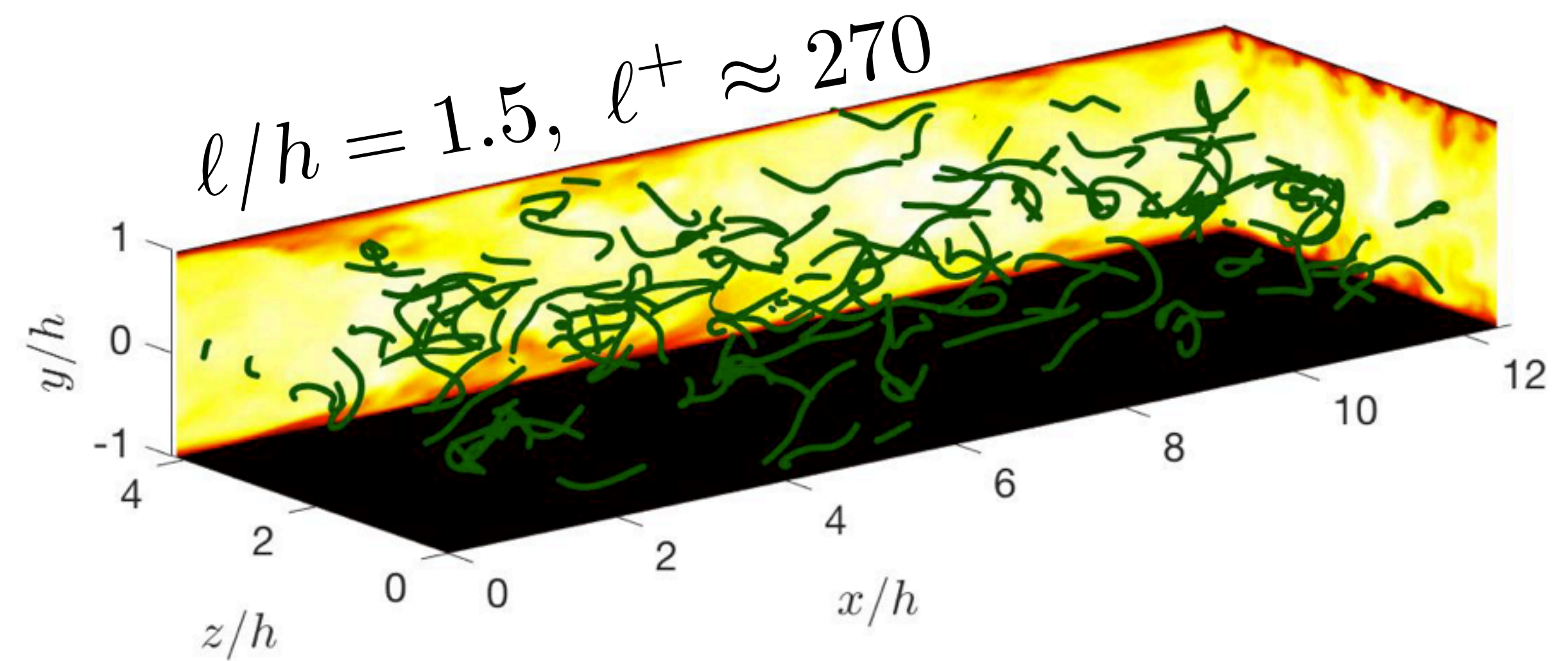
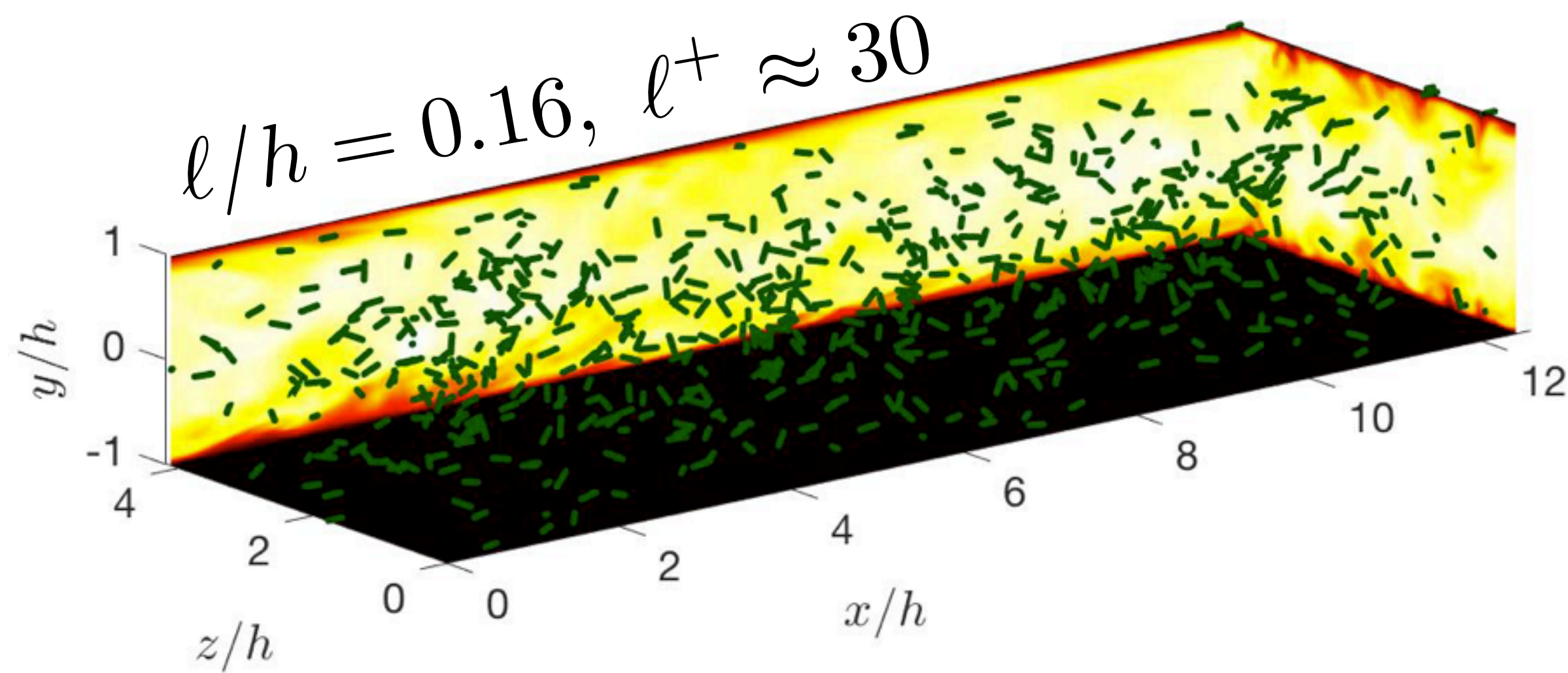

● Fibre orientation:

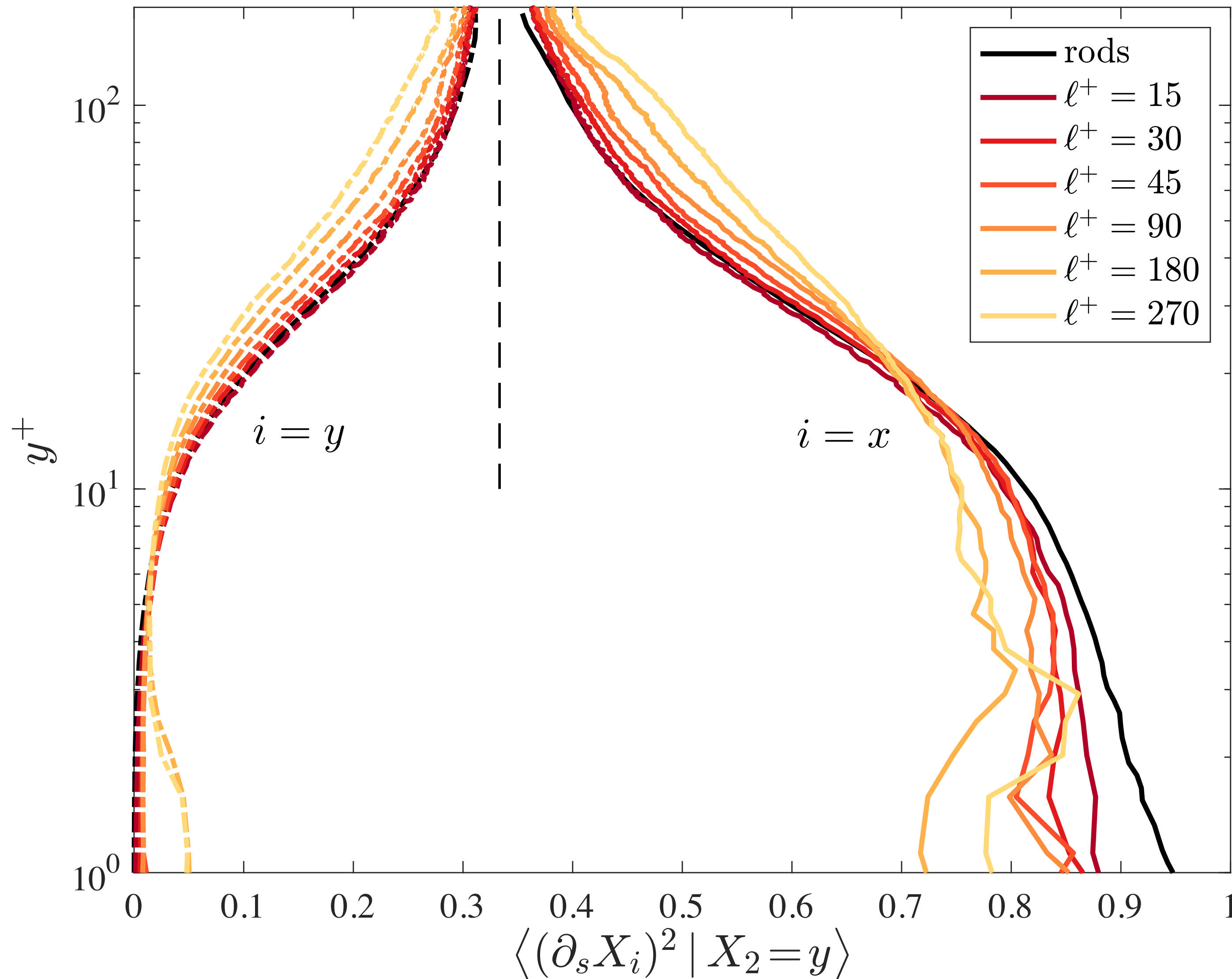

- in the centre: relatively isotropic
- close to the wall: aligned with the flow direction
- small variations with length

- Fibre tumbling rate:

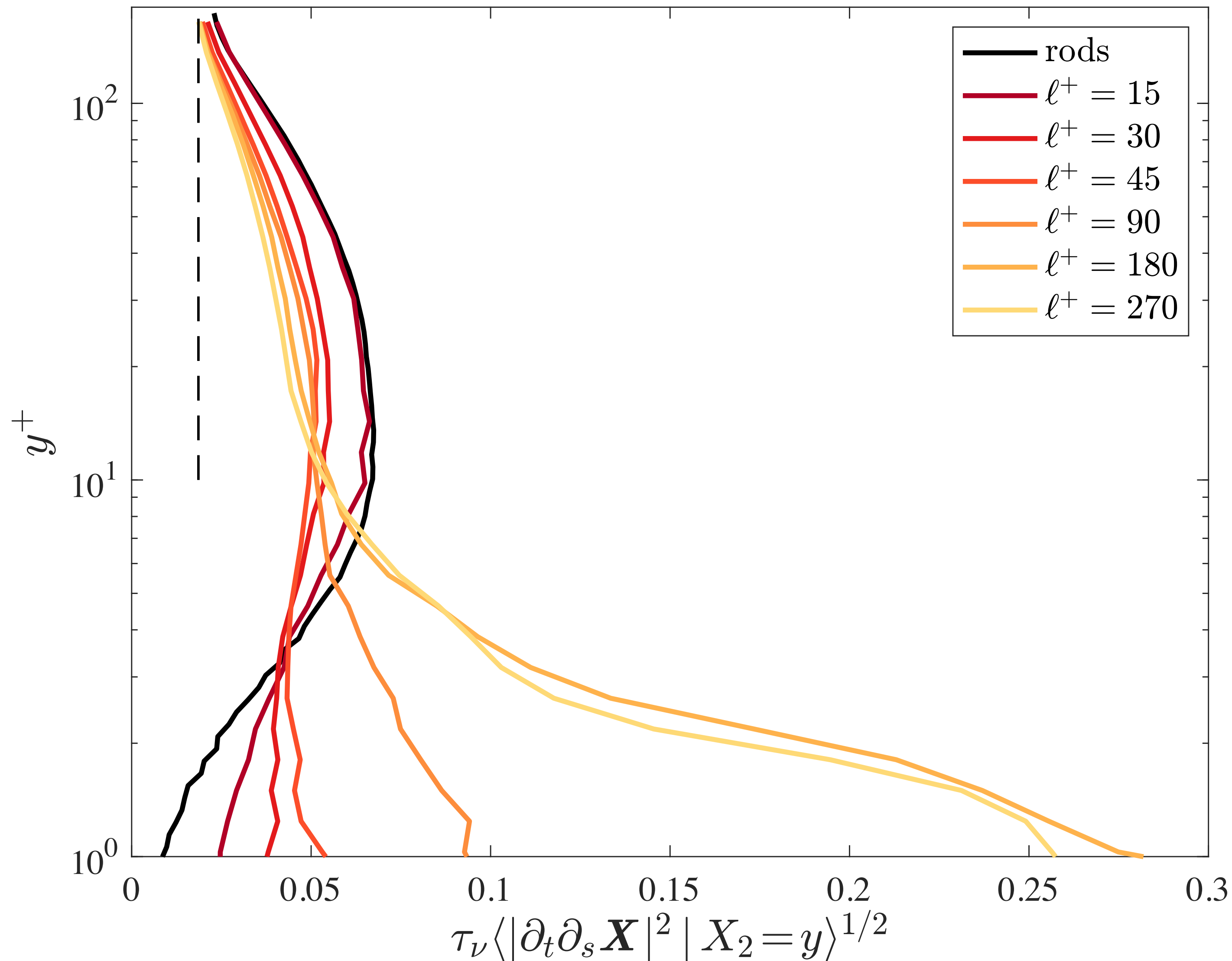

- in the centre:
 - * mainly independent of length
 - * consistent with HIT
- close to the wall:
 - * strong variations with length
 - * the longer, the higher the rate

- Fibre tumbling rate:

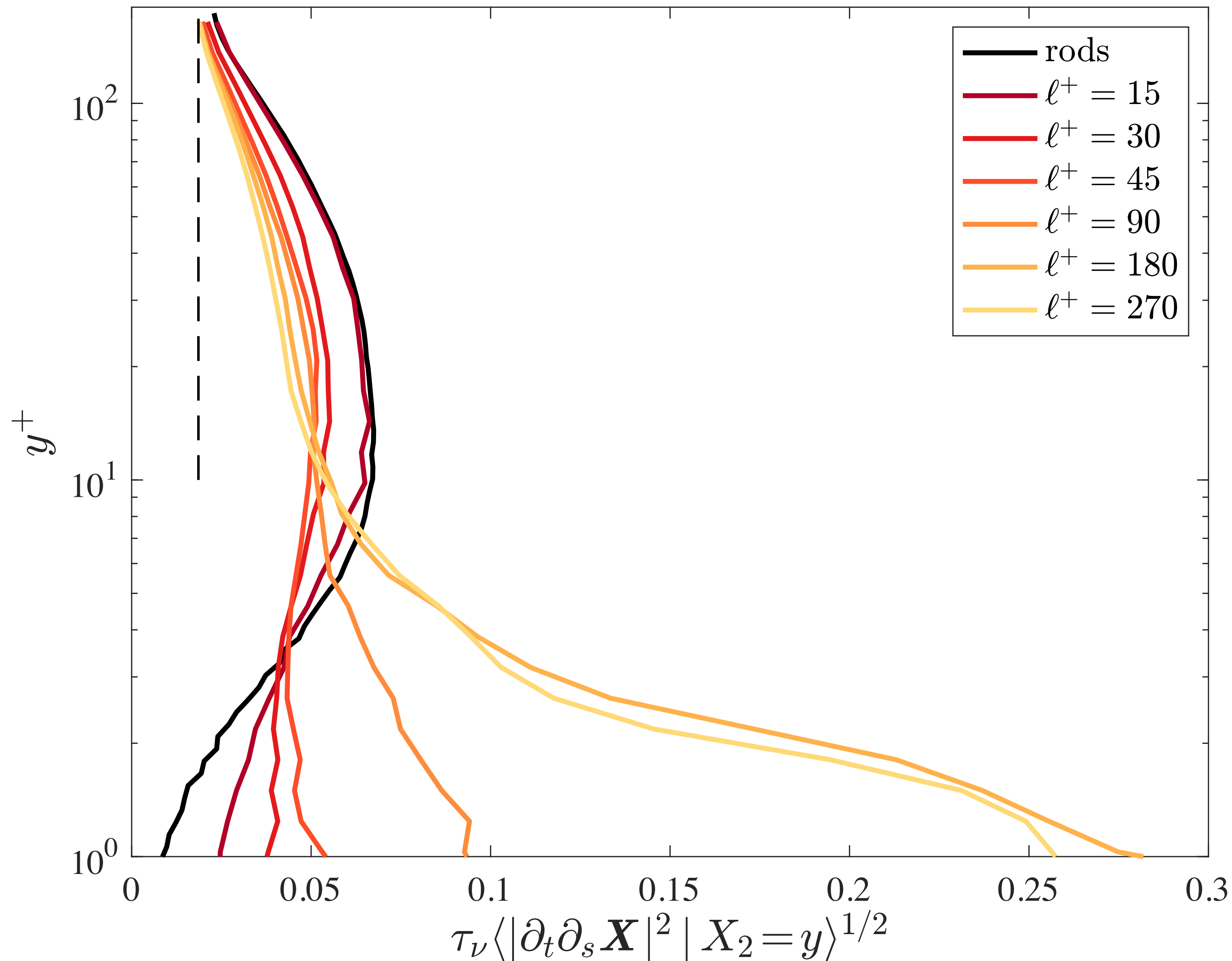

- in the centre:
 - * mainly independent of length
 - * consistent with HIT
- close to the wall:
 - * strong variations with length
 - * the longer, the higher the rate

collisions ?
effects of the wall ?

Baker & Coletti (2022)

Results: pole vaulting

- Fibre-wall interactions:

- rebound on the wall
 - * high tumbling rate
 - * “pole vaulting”

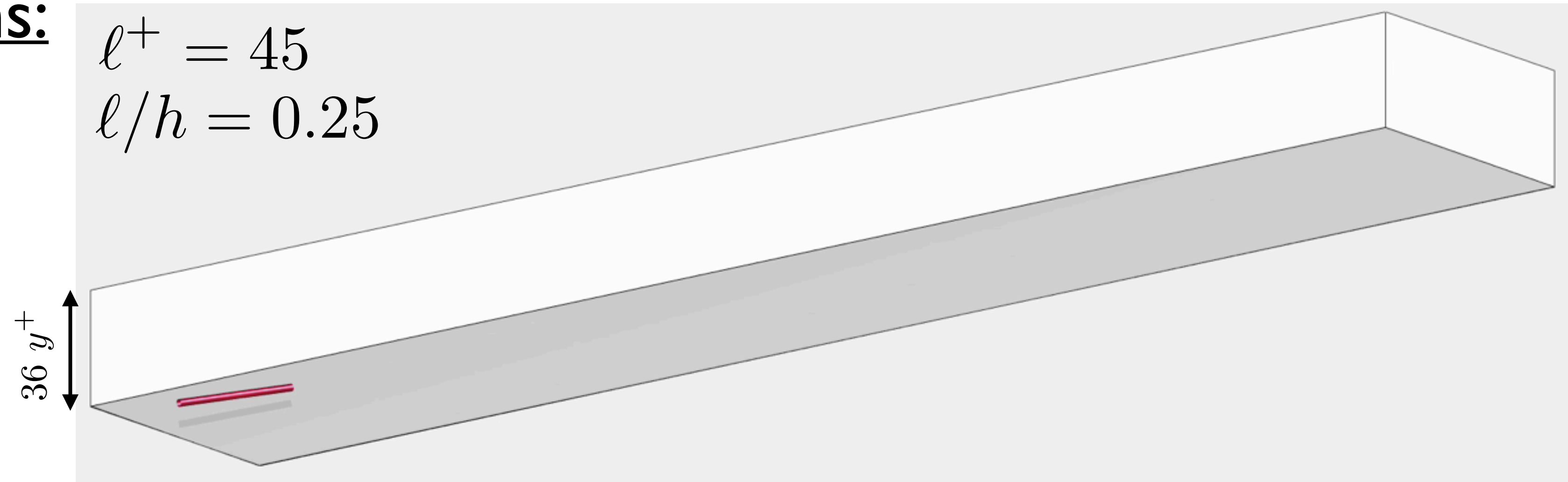

Results: pole vaulting

- Fibre-wall interactions:

$$\ell^+ = 45$$

$$\ell/h = 0.25$$

- rebound on the wall
 - * high tumbling rate
 - * “pole vaulting”

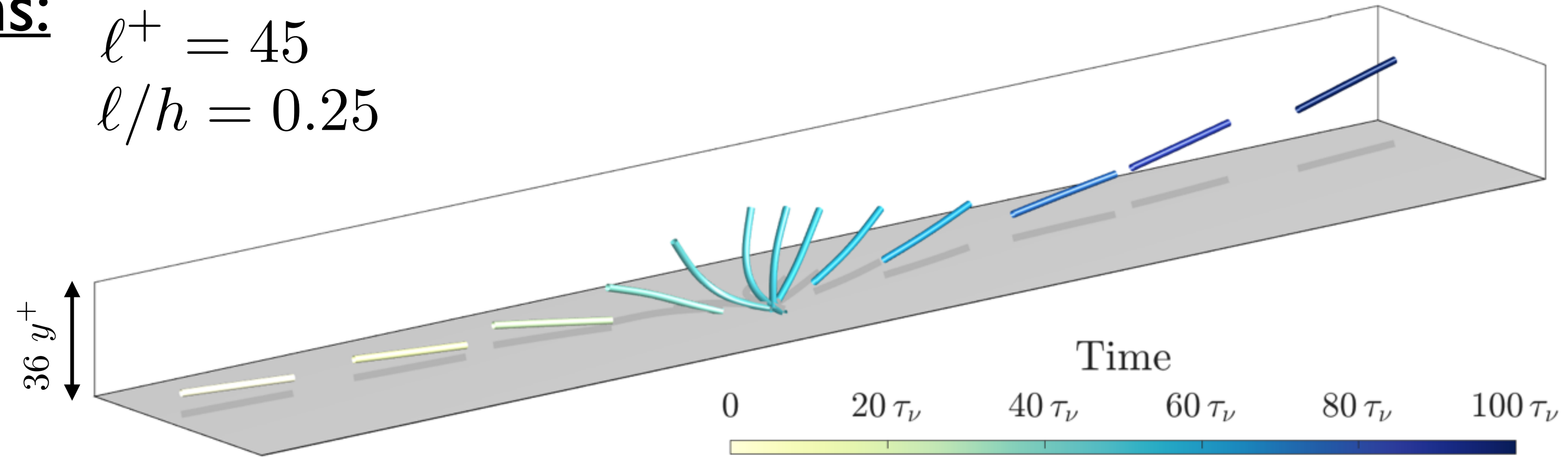

- in the literature:

- * laminar case:

- Stover & Cohen (1990)

- Moses *et al.* (2001)



Stover & Cohen (1990)

Results: pole vaulting

- Fibre-wall interactions:

$$\ell^+ = 45$$
$$\ell/h = 0.25$$

- rebound on the wall
 - * high tumbling rate
 - * “pole vaulting”

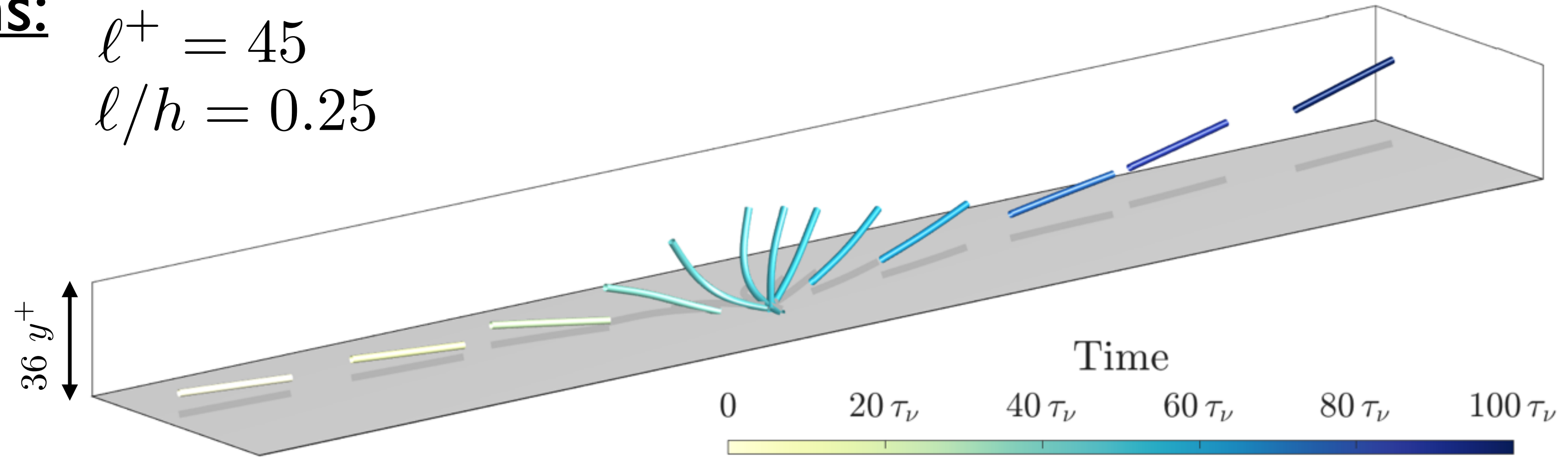

- in the literature:

- * laminar case:

- Stover & Cohen (1990)

- Moses *et al.* (2001)



Stover & Cohen (1990)

(a) $t^+ = 0$

(b) $t^+ = 1.6$

(c) $t^+ = 3.2$

- * turbulent case:

- Capone *et al.* (2017)

- Alipour *et al.* (2022)

- Baker & Coletti (2022)

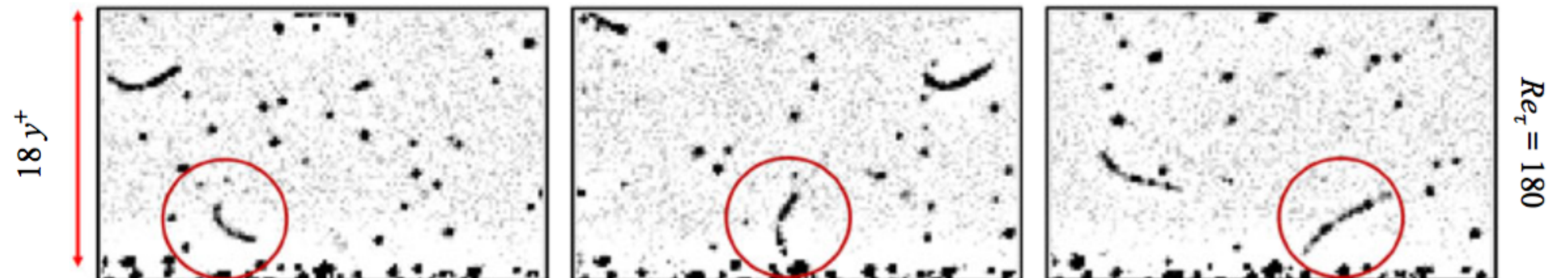

Alipour *et al.* (2022)

● Fibre density distribution:

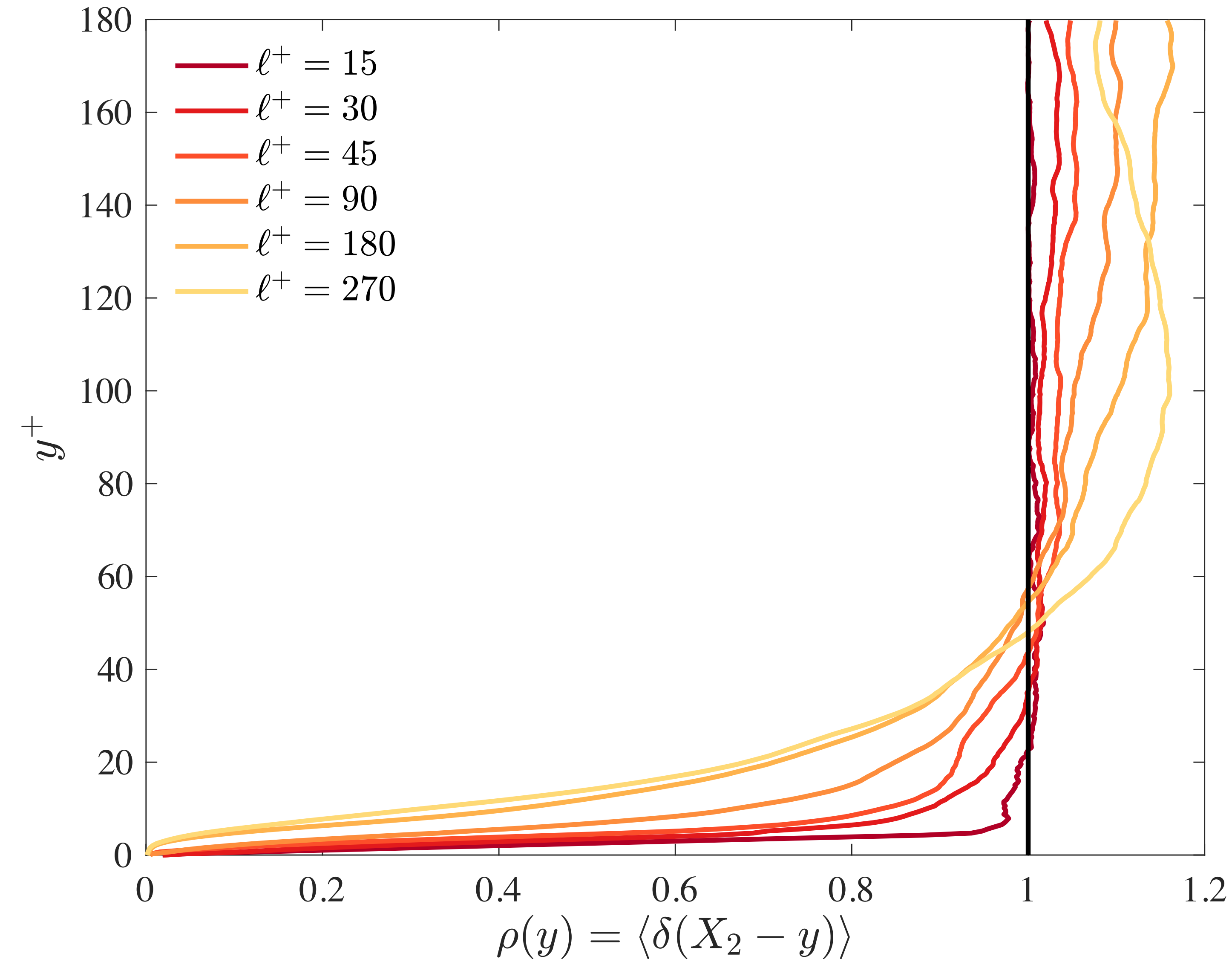

- inhomogeneous distribution:
 - * higher concentration in the center
 - * depleted region close to the wall
 - * increases with fibre length

due to wall collisions ?

● Fibre density distribution:

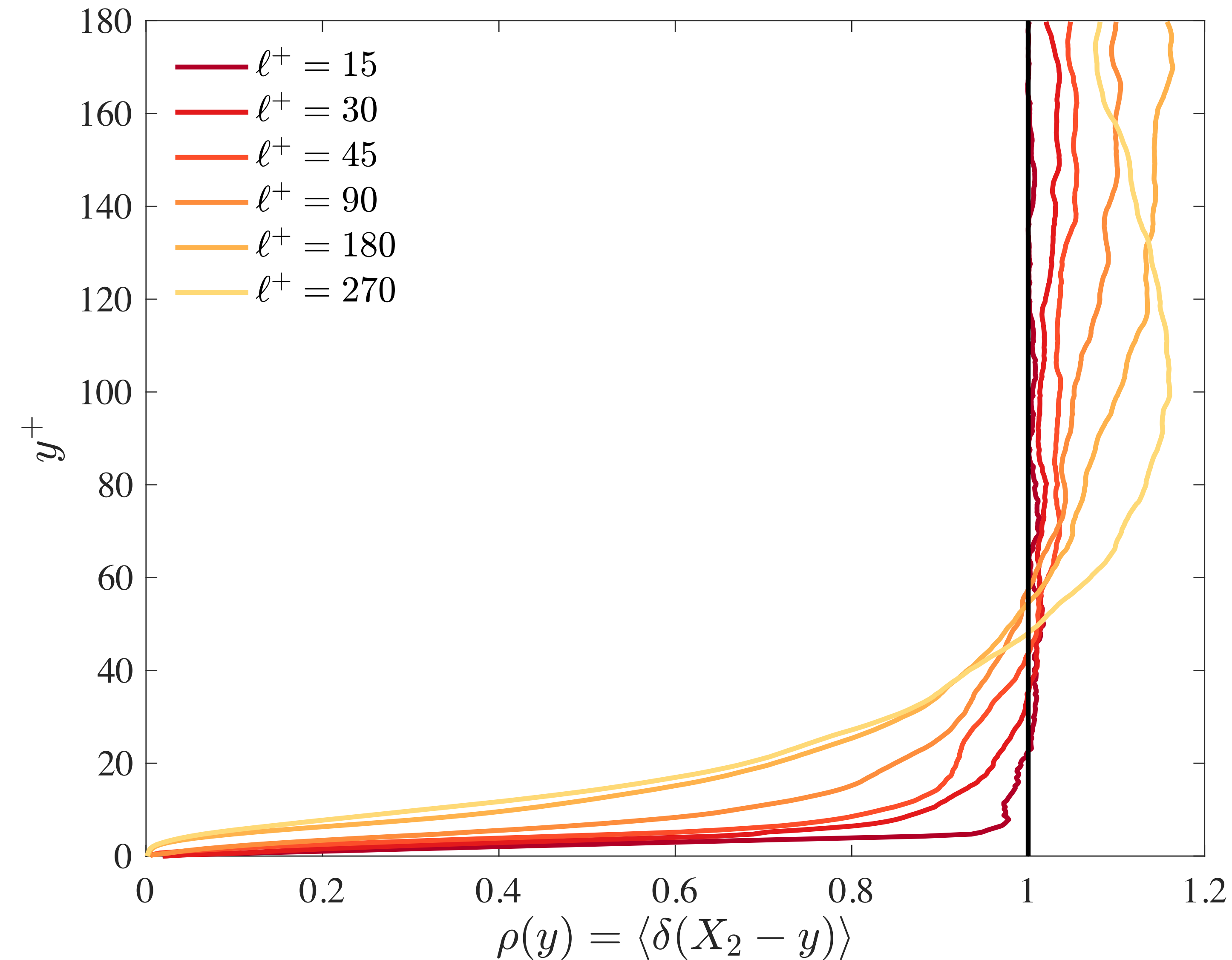

- inhomogeneous distribution:
 - * higher concentration in the center
 - * depleted region close to the wall
 - * increases with fibre length

- high collision probability when tumbling if $y_{CoM}^+ < \ell^+ / 2$

due to wall collisions ?

● Fibre density distribution:

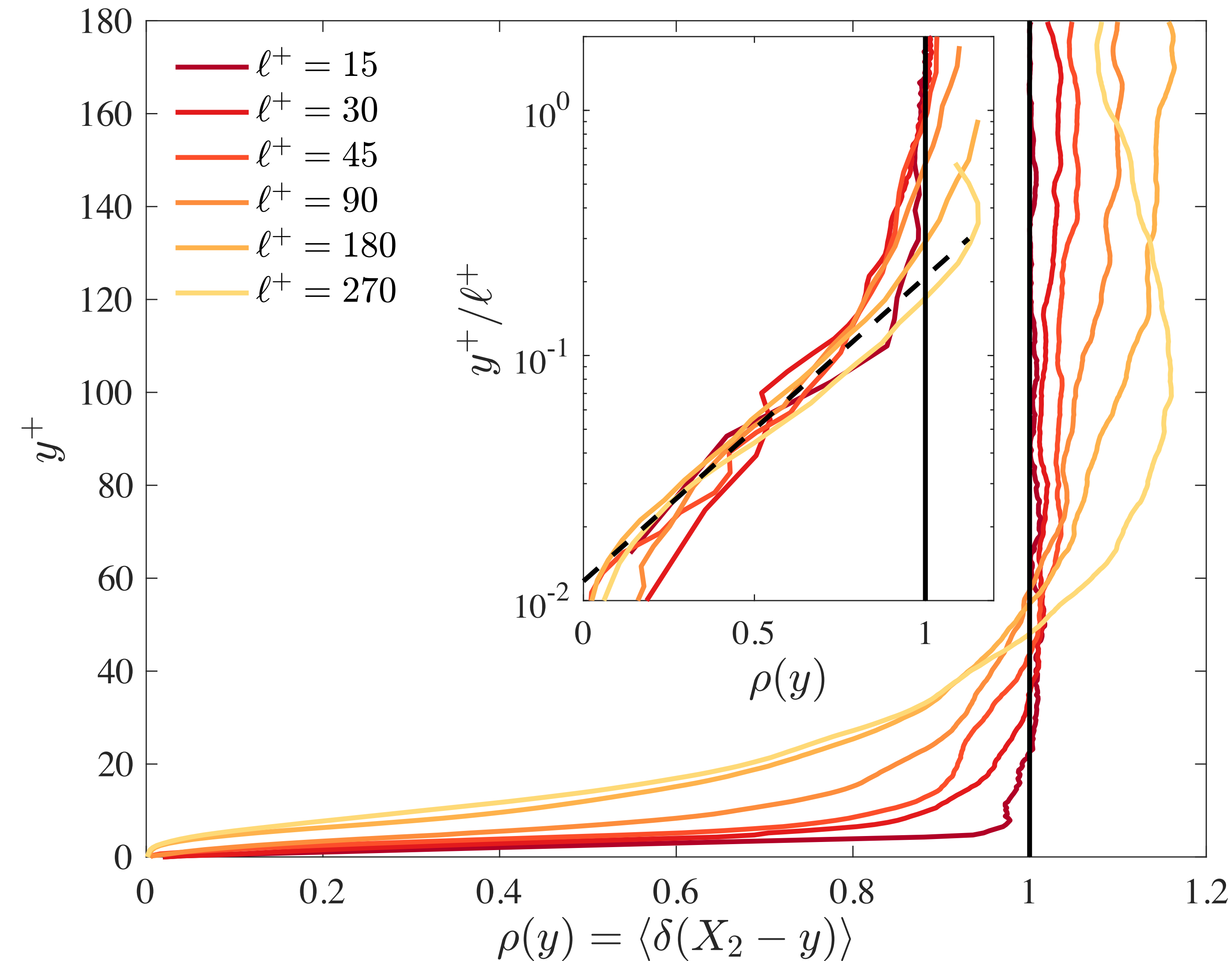

- inhomogeneous distribution:
 - * higher concentration in the center
 - * depleted region close to the wall
 - * increases with fibre length
- high collision probability when tumbling if $y_{CoM}^+ < \ell^+/2$

due to wall collisions !

- Fibre net flux:

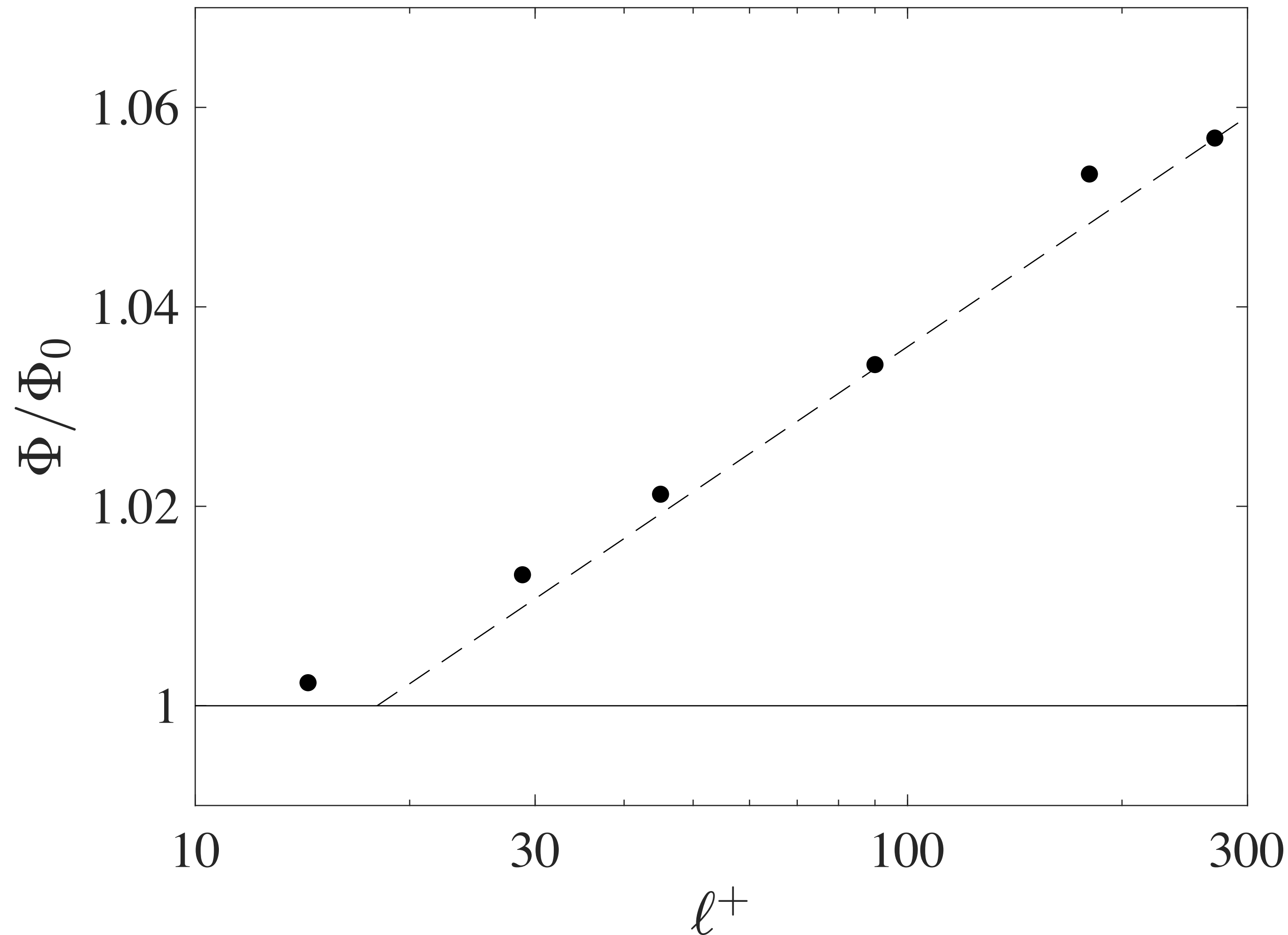

- fibres net flux Φ :
 - * velocity \times concentration
 - * compared to fluid flux Φ_0
 - * increases with fibre length
- enhancement:
 - * for fibre length within the log-layer
 - * log law scaling?

effect on the flux !

Conclusions

- Main results:

- first study on long flexible fibres in turbulent channel flow

- * numerical simulations

- * $\ell/h \in [0.08 - 1.5]$

- fibre-wall collisions: “pole vaulting”

- * high tumbling rates

- * depleted regions

increase with fibre length !

- effect on the fibre net flux:

- * higher fibre concentration in the centre

- * enhancement of the flux up to 6%

To go further

● Experiments at INPHYNI:

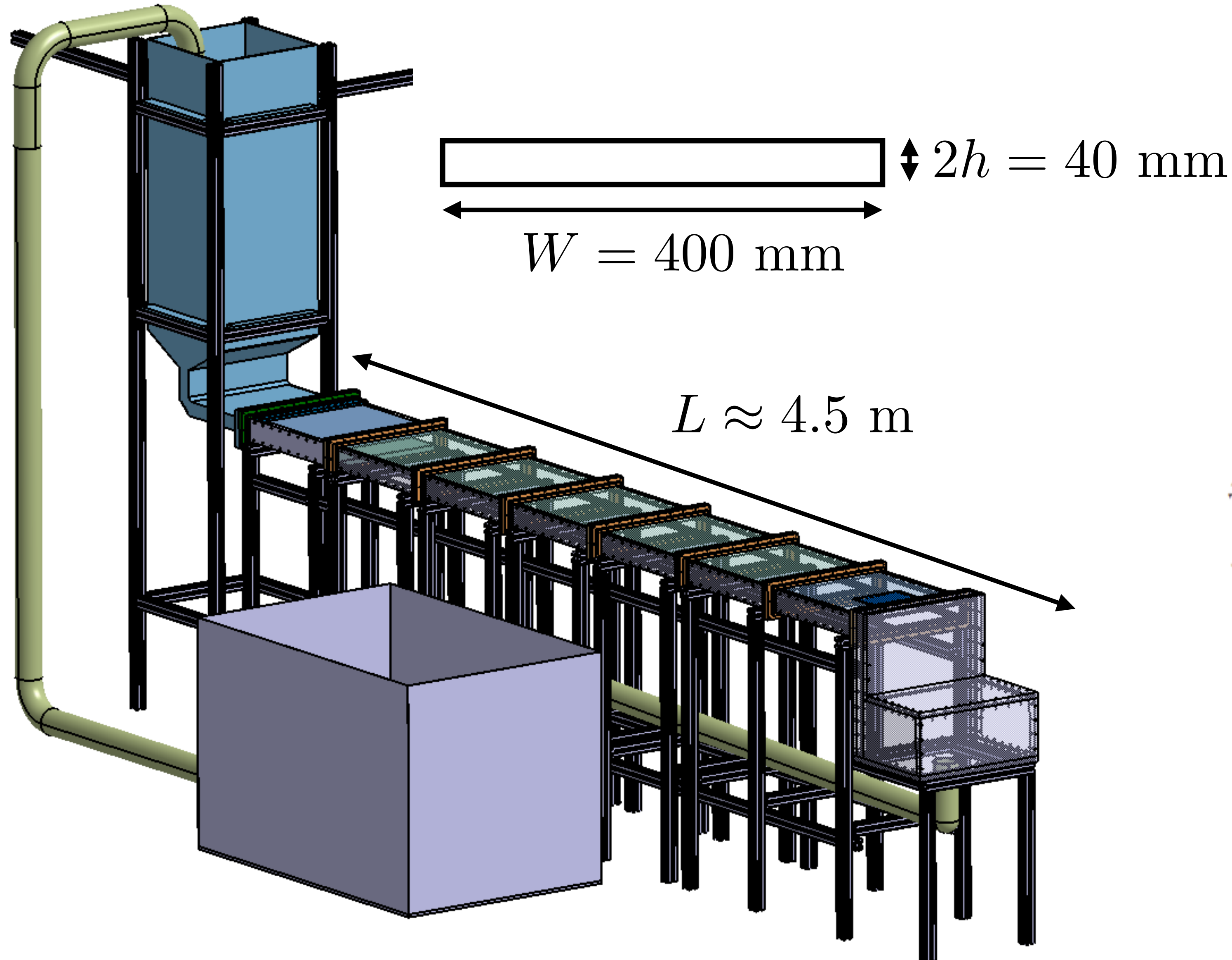

- turbulent channel flow:
 - * rectangular cross-section
 - * gravity driven
- 3D reconstruction:
 - * orientation / deformation
 - * 4 high-speed cameras (20 000 fps at 1 MPixels)

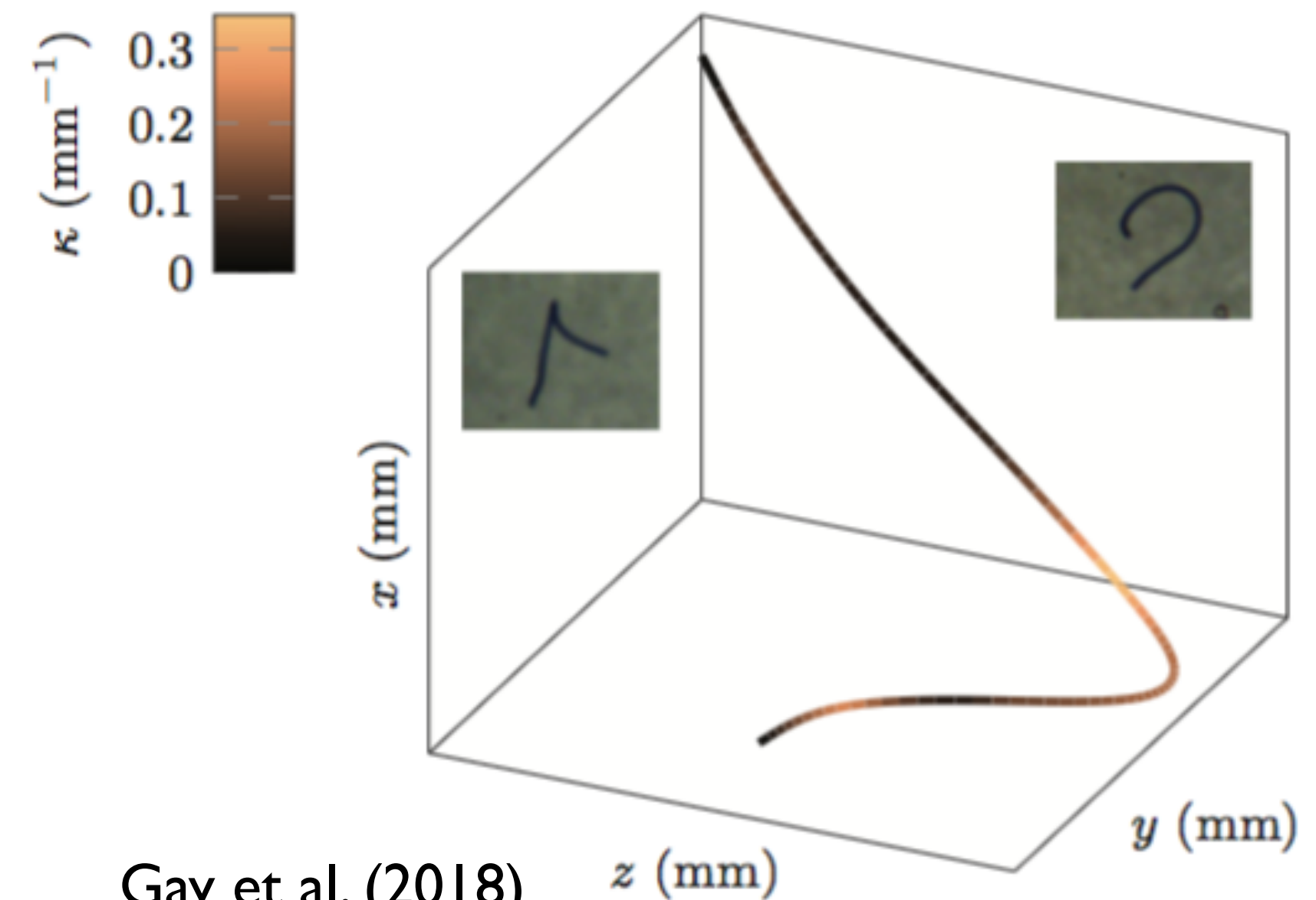

To go further

- Experiments at INPHYNI:

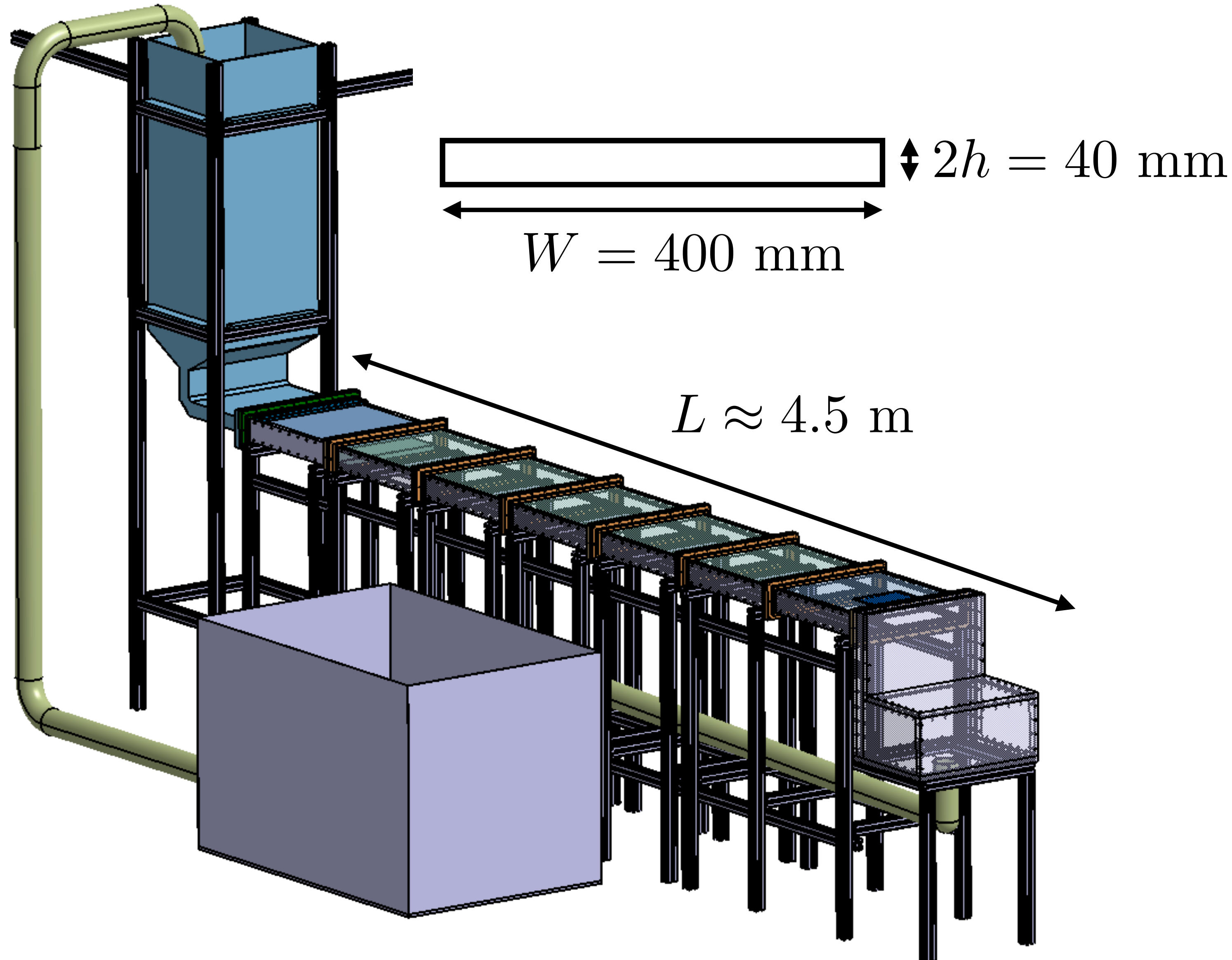

- turbulent channel flow:
 - * rectangular cross-section
 - * gravity driven
- 3D reconstruction:
 - * orientation / deformation
 - * 4 high-speed cameras (20 000 fps at 1 MPixels)
- Fundings:
 - * IDEX (Académie 2)
 - * CNRS
 - * INPHYNI
 - * Région Sud

To go further

- Experiments at INPHYNI:



- turbulent channel flow:
 - * rectangular cross-section
 - * gravity driven
- 3D reconstruction:
 - * orientation / deformation
 - * 4 high-speed cameras (20 000 fps at 1 MPixels)
- Design & manufacturing:
 - * Sandra Bosio
 - * Cyrille Claudet
 - * Christophe Pitiot
 - * Florian Zumbo
 - * Magali Varlet-Dusaucy

Questions ?

- Fibres:

- inextensible and inertialess

- one-way coupling

- over-damped slender-body theory:

- * discretisation in N_s points of length $\delta s^+ = l^+ / N_s \approx 0.9$

- * Cosserat equation for $\mathbf{X}(s, t)$

$$\partial_t \mathbf{X} = \mathbf{u}(\mathbf{X}, t) + \frac{c}{8\pi\eta} [\mathbb{I} + \partial_s \mathbf{X} \partial_s \mathbf{X}^\top] [\partial_s (T \partial_s \mathbf{X}) - EI \partial_s^4 \mathbf{X}]$$

$$\text{with } |\partial_s \mathbf{X}|^2 = 1$$

- elastic length: $\ell_E \equiv (cEI\tau_\nu / (8\pi\eta))^{1/4} \approx 7.1\delta_\nu$

- wall contact: soft boundary approach

- Fibres:
 - wall contact: soft boundary approach
 - fibres are:
 - * allowed to penetrate the wall
 - * strongly repulsed by an effective force
 - fluid velocity outside the domain $\mathbf{u} = (0, v, 0)$

$$\text{bottom} \begin{cases} v = -\gamma(y + h) \\ \text{for } y < -h \end{cases}$$

$$\text{with } \gamma = 0.5/\Delta t$$

$$\text{top} \begin{cases} v = -\gamma(y - h) \\ \text{for } y > h \end{cases}$$