

Rapport d'Opération d'Archéologie Préventive

Volume II/III – Figures et planches

Chaponnay, Janvier 2016

Région Provence-Alpes-Côte d'Azur / Département du Var (83)

LA FARLÈDE

Projet de centralité - Phases 1 et 2



Code INSEE : 83 054
Code opération Patriarche : 10534
No de site : 83 054 0028
Arrêté de prescription : n° 2012 514
Arrêté de désignation (Phase 1) : 2013 386
Arrêté de désignation (Phase 2) : 2014 516

Sous la direction de Jérôme Grasso

Avec les contributions de : Marie-José Ancel,
Emmanuelle Boissard, Benjamin Clément,
Julien Collombet, Aline Colombier-Gougouzian,
Aurélie Ducreux, Camille Faisse, Sylvain Foucras,
Nicolas Garnier, Amaury Gilles, Catherine
Latour-Argant, Frédéric Magnin.

Ministère de la culture et de la communication
Préfecture de la région Provence-Alpes-Côte d'Azur
Direction des Affaires Culturelles
Service Régional de l'Archéologie
Archeodunum



ARCHEODUNUM
INVESTIGATIONS ARCHEOLOGIQUES

Avertissement

Les rapports de fouille constituent des documents administratifs communicables au public dès leur remise au Service Régional de l'Archéologie, suivant les prescriptions de la loi n° 78-753 du 17 juillet modifiée relative à l'amélioration des relations entre l'administration et le public. Aux termes de la circulaire du 26 mars 1993, ils pourront être consultés ; les agents des Services régionaux de l'archéologie rappelleront à tout demandeur les droits de propriété littéraires et artistiques possédés par les auteurs et les contraintes qui en résultent pour tout consultant. Les prises de notes et les photocopies sont utilisées pour un usage exclusivement privé et non destiné à une utilisation collective (article L122-5 du code de la propriété intellectuelle). Toute reproduction du texte accompagnée ou non de photographies, cartes ou schémas, n'est possible que dans le cadre du droit de courte utilisation, avec les références exactes et complètes de l'auteur et de l'ouvrage. Par ailleurs, l'exercice du droit à la communication exclut, pour ses bénéficiaires ou pour les tiers, la possibilité de reproduire, de diffuser ou d'utiliser à des fins commerciales les documents communiqués (Loi n° 78-753 du 17 juillet, art. 10).

Le non respect de ces règles constitue un délit de contrefaçon puni par l'article 425 du code pénal.

DÉPARTEMENT DU VAR (83)

La Farlède : Projet de centralité - Phases 1 et 2
Rapport d'Opération d'Archéologie Préventive

Illustration de couverture : modélisation 3D de l'hypocauste à partir de relevés photogrammétriques (Clichés : David Baldassari ; infographie : Quentin Rochet, PhotoScan)

Sous la direction de Jérôme Grasso

Rédaction de : Jérôme Grasso et David Baldassari

Avec les contributions de Marie-José Ancel, Emmanuelle Boissard, Benjamin Clément, Julien Collombet, Aline Colombier-Gougouzian, Aurélie Ducreux, Camille Faïsse, Sylvain Foucras, Nicolas Garnier, Amaury Gilles, Catherine Latour-Argant, Frédéric Magnin.

Mise en page : Sandrine Swal

Sommaire

Volume II – Figures et planches

Liste des figures.....	212
Figures.....	218
Liste des planches.....	356
Planches.....	357

Fig. 1 : Localisation du site à l'échelle régionale (1/250 000) - Fond de carte IGN-Géoportail (2014) (DAO : D. Baldassari).

Fig. 2 : Localisation du site à l'échelle locale (1/25 000) - Fond de carte IGN-Géoportail (2015) (DAO : D. Baldassari).

Fig. 3 : Localisation de l'emprise prescrite sur le plan cadastral du Var, La Farlède, section AB, éch. 1/600 (cadastre.gouv.fr, 2013). (DAO : D. Baldassari).

Fig. 4 : Périmètre de l'emprise fouillée, localisée sur le plan cadastral du Var, La Farlède, section AB, éch. 1/600 (cadastre.gouv.fr, 2013). (DAO : D. Baldassari).

Fig. 5 : Localisation du site sur la carte géologique. Carte géologique de la France 1:50 000 – 1064N - Toulon - XXXIII-46. (DAO : D. Baldassari).

Fig. 6 : Localisation de l'emprise sur une photographie aérienne (geoportail.gouv, IGN, 2011). (DAO : D. Baldassari).

Fig. 7 : Contexte archéologique de l'Antiquité autour du site Projet de centralité, rue du Partégal. Fond de carte IGN-Géoportail (2015). (DAO : D. Baldassari).

Fig. 8 : Localisation de l'emprise sur le cadastre napoléonien du Var, La Farlède, cote 3PP_054_09, section B dite de la Farlède, 1848 (archives.var.fr). (DAO : D. Baldassari).

Fig. 9 : Localisation de la fouille sur le fond de plan du diagnostic (Conche 2012, p. 24). (DAO : D. Baldassari).

Fig. 10 : Surveillance du dessouchage et de la dépose des massifs de fondations des bâtiments. (Clichés : Archeodunum).

Fig. 11 : Vues de l'emprise de fouille inondée au lendemain du premier épisode de précipitations orageuses le 9 septembre 2013. (Clichés : Archeodunum).

Fig. 12 : Vue aérienne de l'emprise fouillée en 2013. Vue aérienne centrée sur le Bâtiment 2. (Clichés : Laurent Boudereaux – *Lou Parpaioun*).

Fig. 13 : Plan-masse général des vestiges, toutes époques confondues (éch. : 1/300). (DAO : D. Baldassari, J. Grasso).

Fig. 14 : Plan des vestiges de la Phase 1 : deuxième tiers du I^{er} s. ap. J.-C. – seconde moitié du II^e s. (éch. : 1/300). (DAO : D. Baldassari, J. Grasso).

Fig. 15 : Plan des vestiges de la Phase 2 : fin du IV^e s. – début du VI^e s. (éch. : 1/300). (DAO : D. Baldassari, J. Grasso).

Fig. 16 : Plan des vestiges de la Phase 3 : vestiges antiques qui ne peuvent être rattachés avec certitude à la Phase 1 ou à la Phase 2 (éch. : 1/300). (DAO : D. Baldassari, J. Grasso).

Fig. 17 : Plan des vestiges dont la datation est indéterminée (éch. : 1/300). (DAO : D. Baldassari, J. Grasso).

Fig. 18 : Plan des vestiges de la Phase 4 : Époques moderne et contemporaine (éch. : 1/300). (DAO : D. Baldassari, J. Grasso).

Fig. 19 : Diagramme stratigraphique du secteur est. (DAO : D. Baldassari).

Fig. 20 : Plan des Ensembles et des Entités (éch. : 1/300). (DAO : D. Baldassari, J. Grasso).

Fig. 21 : Coupes des chenaux 1260, 1261 et 1257 (éch. : 1/20). (DAO : C. Fäisse).

- Fig. 22 :** Logs géomorphologiques (éch. : 1/20). (DAO : C. Faisse).
- Fig. 23 :** TRG 1001 (éch. : 1/20). (DAO : C. Faisse).
- Fig. 24 :** TRG 1002 (éch. : 1/20). (DAO : C. Faisse).
- Fig. 25 :** TRG 2001 (éch. : 1/20). (DAO : C. Faisse).
- Fig. 26 :** TRG 2002 (éch. : 1/20). (DAO : C. Faisse).
- Fig. 27 :** Log 2001 (éch. : 1/20). (DAO : D. Baldassari, J. Grasso).
- Fig. 28 :** Plan du Bâtiment 1 (éch. : 1/100). (DAO : Q. Rochet, D. Baldassari).
- Fig. 29 :** Plan de la moitié ouest du Bâtiment 2 (éch. : 1/100). (DAO : Q. Rochet, D. Baldassari).
- Fig. 30 :** Plan de la moitié est du Bâtiment 2 (éch. : 1/100). (DAO : Q. Rochet, D. Baldassari).
- Fig. 31 :** Vue de l'angle nord-ouest de l'emprise, traces de labours. Vue en coupe de la fosse dépotoir contemporaine implantée à l'angle sud-est de la cuve CV1049. (Clichés : Archeodunum).
- Fig. 32 :** Coupes des structures en creux implantées dans les espaces PCE1021, PCE1022 et PCE1023 : FS1152, FS1107, FS1171, PO1151, PO1147, PO1144 et PO1108 (éch. : 1/20). (DAO : D. Baldassari, J. Grasso).
- Fig. 33 :** Vue zénithale de l'aménagement US 1425 traversant le mur MR1035. Vue en coupe des fosses FS1163, FS1164 et FS1165. (Clichés : Archeodunum).
- Fig. 34 :** Coupes des fosses implantées dans l'espace PCE1026 : FS1041, FS1042, FS1163, FS1164 et FS1165 (éch. : 1/20). (D. Baldassari, J. Grasso).
- Fig. 35 :** Plan de l'état 1 du Bâtiment 3 et coupes des fosses à *dolia* du chai STK1035. (éch. : 1/100). (DAO : Q. Rochet, D. Baldassari).
- Fig. 36 :** Plan de l'état 2 du Bâtiment 3 (éch. : 1/100). (DAO : Q. Rochet, D. Baldassari).
- Fig. 37 :** Vues d'ensemble du chai STK1035 dans le Bâtiment 3. (Clichés : Archeodunum).
- Fig. 38 :** Vue de la coupe est-ouest de la fosse de calage de *dolium* FS1183. Vue du fond de la fosse de calage de *dolium* FS1183. (Clichés : Archeodunum).
- Fig. 39 :** Plan de la cuve CV1064 (éch. : 1/25). Coupe des structures TR1102, TR1130, TR1131, TR1128 et FS1127 (éch. 1/20). (DAO : D. Baldassari, J. Grasso).
- Fig. 40 :** Plan et profil transversal de la cuve CV1049 (éch. : 1/20). (DAO : D. Baldassari, J. Grasso).
- Fig. 41 :** Vue en plan de la cuve CV1049. Vue de détail de la cupule US 1461 sur le fond de la cuve CV1049. (Clichés : Archeodunum).
- Fig. 42 :** Vue de détail de la conduite d'évacuation de la cuve CV1049. Vue de détail du bourrelet d'étanchéité de la cuve CV1049. (Clichés : Archeodunum).
- Fig. 43 :** Vues en plan de la cuve CV1064. (Clichés : Archeodunum).
- Fig. 44 :** Vues de détail de la cupule US 1467 et de son bouchage sur le fond de la cuve CV1064. (Clichés : Archeodunum).
- Fig. 45 :** Vue d'ensemble de l'espace situé au sud de la cuve CV1064 avec l'évacuation CN1178. Vue en plan de la canalisation CN1178. (Clichés : Archeodunum).
- Fig. 46 :** Plan de la cuve CV1031 (éch. : 1/20). (DAO : D. Baldassari, J. Grasso).
- Fig. 47 :** Vue en plan des vestiges de la cuve CV1031. Vue générale de la « loge à cochons » PCE1091. (Clichés : Archeodunum).
- Fig. 48 :** Plan des bases de piliers BP1052, BP1053, BP1054, BP1135 et BP1139 (éch. : 1/25). (D. Baldassari, J. Grasso).

- Fig. 49** : Vues en plan des bases de piliers BP1052 et BP1059. (Clichés : Archeodunum).
- Fig. 50** : Coupes des fosses FS1174, FS1082 et FS1173 (éch. : 1/20). (DAO : D. Baldassari, J. Grasso).
- Fig. 51** : Plan du mur MR1051 (éch. : 1/100). (DAO : Q. Rochet, D. Baldassari).
- Fig. 52** : Plan du Bâtiment 4 (éch. : 1/50). (DAO : Q. Rochet, D. Baldassari).
- Fig. 53** : Vues de détail du bloc (mégalithe ?) réemployé dans le chaînage des murs MR1012 et MR1013. (Clichés : Archeodunum).
- Fig. 54** : Plan de l'espace PCE1051 (éch. : 1/50). (DAO : D. Baldassari, J. Grasso).
- Fig. 55** : Coupes des fosses FS1070, FS1154, FS1156 et FS1159 (éch. : 1/20). (D. Baldassari, J. Grasso).
- Fig. 56** : Plan de l'espace PCE1071 (éch. : 1/50). (DAO : D. Baldassari, J. Grasso).
- Fig. 57** : Vue en plan des murs formant l'espace PCE1071. Vue générale de l'hypocauste, départ de la canalisation CN1161. (Clichés : Archeodunum).
- Fig. 58** : Plan de l'hypocauste (éch. : 1/20). (DAO : D. Baldassari, J. Grasso).
- Fig. 59** : Coupes longitudinale et transversale de l'hypocauste et plans de la canalisation CN1161 localisée sous le sol en béton de tuileau UC 1023 (éch. : 1/50). (DAO : D. Baldassari, J. Grasso).
- Fig. 60** : Vue générale et détail du trou US 1290 perforant le sol bétonné SL1132 de l'hypocauste. (Clichés : Archeodunum).
- Fig. 61** : Vue du trou de poteau PO1168 installé dans l'angle sud-ouest de l'espace ESP1063 de l'hypocauste. Vue en plan de la partie couverte de la canalisation CN1161. (Clichés : Archeodunum).
- Fig. 62** : Vue en plan de la canalisation CN1162. Vue en plan de la jonction des canalisations CN1161 et CN1162. (Clichés : Archeodunum).
- Fig. 63** : Vues partielles de la couverture de la canalisation CN1161 sous la chape de mortier de tuileau US 1023 de l'hypocauste, avant et après démontage. (Clichés : Archeodunum).
- Fig. 64** : Vues de détail de la coupe nord-sud pratiquée dans la chape de mortier de tuileau US 1023 de l'hypocauste, implantation de la canalisation CN1161. (Clichés : Archeodunum).
- Fig. 65** : Modélisation 3D de l'hypocauste réalisée à partir des relevés photogrammétriques. (Clichés : D. Baldassari ; infographie : Q. Rochet).
- Fig. 66** : Vues de détail du seuil réemployé dans la maçonnerie du mur MR1215 de l'hypocauste. (Clichés : Archeodunum).
- Fig. 67** : Plan des puits PT1117 et PT1149 (éch. 1/100). (D. Baldassari, J. Grasso).
- Fig. 68** : Coupe du puits PT1117 (éch. : 1/20). (D. Baldassari, J. Grasso).
- Fig. 69** : Vue de la coupe du niveau supérieur du puits PT1117. Vue partielle du cuvelage du puits PT1117. (Clichés : Archeodunum).
- Fig. 70** : Vue de la coupe est-ouest du puits PT1117. Vue de détail du surcreusement dans le fond du puits PT1117. (Clichés : Archeodunum).
- Fig. 71** : Vue de détail du fond du puits PT1117 et des fonds d'amphores colmatés par l'US 1267. Bloc retrouvé au fond du puits PT1117, US 1267 (meule dormante). (Clichés : Archeodunum).
- Fig. 72** : Coupe du puits PT1149 (éch. : 1/20). (D. Baldassari, J. Grasso).
- Fig. 73** : Vue en plan de la moitié ouest du puits PT1149. Vue partielle de la coupe sud-nord du puits PT1149. (Clichés : Archeodunum).
- Fig. 74** : Vue de la coupe intégrale du puits PT1149. Vue en coupe du puits PT2040 avec son bouchage. (Clichés : Archeodunum).

- Fig. 75 :** Plan de localisation du puits PT2040 (éch. : 1/100). (D. Baldassari, J. Grasso).
- Fig. 76 :** Plan et coupe du puits PT2040 (éch. : 1/20). (D. Baldassari, J. Grasso).
- Fig. 77 :** Vue du puits PT2040 partiellement vidé. Vue de détail des fragments de cuve issus du bouchage du puits PT2040 (US 2166). (Clichés : Archeodunum).
- Fig. 78 :** Plan et coupe du collecteur CN1113 (éch. : 1/50). (D. Baldassari, J. Grasso).
- Fig. 79 :** Vue d'ensemble du collecteur CN1113. Vue en plan de la canalisation CN1097 (Clichés : Archeodunum).
- Fig. 80 :** Plan et coupe de la canalisation CN1097 (éch. : 1/20). (D. Baldassari, J. Grasso).
- Fig. 81 :** Vues du départ de la canalisation CN1032 au niveau du mur MR1035, avant et après démontage de la couverture. (Clichés : Archeodunum).
- Fig. 82 :** Vue de détail du piédroit nord de la canalisation CN1032. Vue de la coupe sud-nord de la canalisation CN1032. (Clichés : Archeodunum).
- Fig. 83 :** Plan et coupes de la canalisation CN1162 (éch. : 1/50). (D. Baldassari, J. Grasso).
- Fig. 84 :** Plan de localisation des coupes des fossés FO2031, FO2032, FO2033, FO2053 et FO2054 (éch. : 1/300). (D. Baldassari, J. Grasso).
- Fig. 85 :** Coupes des fossés FO2031, FO2032, FO2033, FO2053 et FO2054 (éch. : 1/20). (DAO : D. Baldassari, J. Grasso).
- Fig. 86 :** Coupe du fossé FO1213 (éch. : 1/20). (D. Baldassari, J. Grasso).
- Figure 87 :** relevés en plan et profils de la tombe SP2009 (éch. : 1/20) ; cliché en cours de fouille. (DAO : J. Grasso, D. Baldassari ; cliché : J. Grasso).
- Figure 88 :** relevés en plan des tombes SP2010, SP2064 et SP2067 (éch. : 1/20) ; cliché du niveau d'apparition des 3 tombes. (DAO : J. Grasso, D. Baldassari ; cliché : D. Baldassari).
- Figure 89 :** relevés en coupe des tombes SP2010 et SP2064 (éch. : 1/20) ; clichés en cours de fouille. (DAO : J. Grasso, D. Baldassari ; clichés : D. Baldassari).
- Figure 90 :** relevés en plan et en coupe de la tombe SP2067 (éch. : 1/10) ; clichés en cours de fouille. (DAO : J. Grasso, D. Baldassari ; clichés : A. Collet).
- Figure 91 :** relevés en plan et en coupe de la tombe SP2104 (éch. : 1/10) ; vue du niveau d'apparition. (DAO : J. Grasso, D. Baldassari ; cliché : A. Collet).
- Figure 92 :** relevés en plan et en coupe de la tombe SP2105 (éch. : 1/10) ; vue en plan du niveau d'apparition. (DAO : J. Grasso, D. Baldassari ; cliché : A. Collet).
- Fig. 93 :** Plan et coupe de la fosse FS1068 (éch. : 1/20). (D. Baldassari, J. Grasso).
- Fig. 94 :** Vues en plan et en coupe de la fosse dépotoir FS1068. (Clichés : Archeodunum).
- Fig. 95 :** Coupe et plan de la fosse FS1081 (éch. : 1/20). (D. Baldassari, J. Grasso).
- Fig. 96 :** Plan de localisation de l'aire de battage SB2087 et structures environnantes (éch. : 1/100). (D. Baldassari, J. Grasso).
- Fig. 97 :** Plan de l'aire de battage SB2087 (éch. : 1/20). (D. Baldassari, J. Grasso).
- Fig. 98 :** Vue en plan de l'aire de battage SB2087. Vue en plan et coupe partielle de l'aire de battage SB2087 laissant apparaître les remblais sous-jacents. (Clichés : Archeodunum).
- Fig. 99 :** Plan de localisation des sépultures SP2009, SP2010, SP2064, SP2067, SP2104, SP2105 et structures environnantes (éch. : 1/100). (DAO : D. Baldassari, J. Grasso).
- Fig. 100 :** Plan de localisation et coupes des fosses FS2028 et FS2114 (éch. : 1/100 et 1/20). (DAO : D. Baldassari).

Fig. 101 : Coupes de la berme est (éch. : 1/50). (D. Baldassari, J. Grasso).

Fig. 102 : Plan de localisation et coupe de la fosse FS1126 (éch. : 1/100 et 1/20). (D. Baldassari, J. Grasso).

Fig. 103 : Plan de localisation et coupes des fosses FS1026 et FS1093 (éch. : 1/100 et 1/20). (D. Baldassari, J. Grasso).

Figure 104 : relevé en plan et profils de la tombe SP2019 (éch. : 1/20) ; clichés en cours de fouille. (DAO : J. Grasso, D. Baldassari ; clichés : J. Grasso).

Fig. 105 : Vue en plan du drain-canal moderne CN1008/CN2005. Vue en plan du mur MR2007 coupé par le drain-canal CN1008/CN2005 et par le drain FO2008. (Clichés : Archeodunum).

Fig. 106 : Plan et coupe du drain-canal moderne CN1008/CN2005. (éch. : 1/50 et 1/20). (DAO : D. Baldassari, J. Grasso).

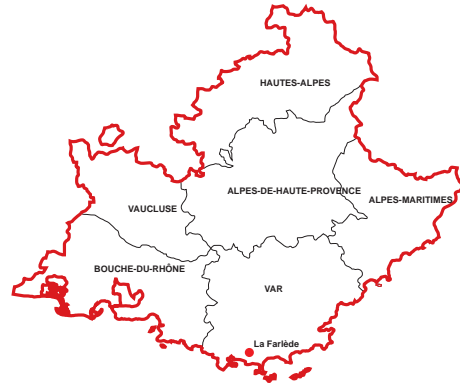
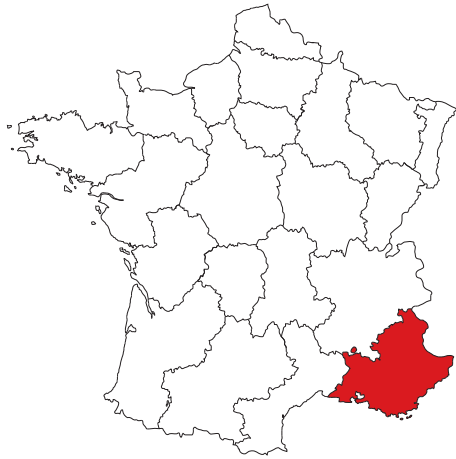
Fig. 107 : Plan et coupe du mur MR2007. (éch. : 1/30). (DAO : D. Baldassari, J. Grasso).

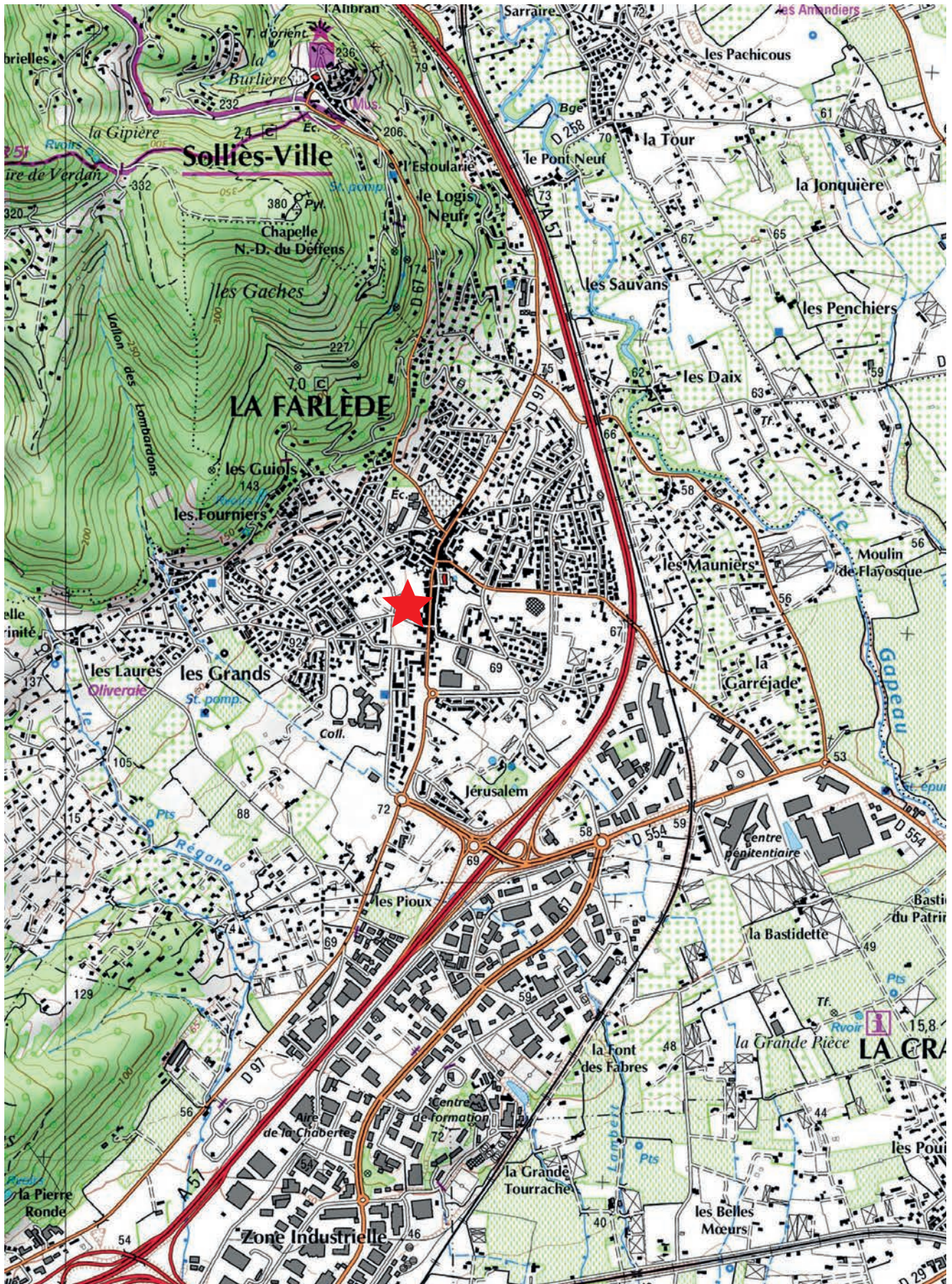
Fig. 108 : Plan de localisation des structures en creux du secteur sud-est (éch. : 1/100). (D. Baldassari, J. Grasso).

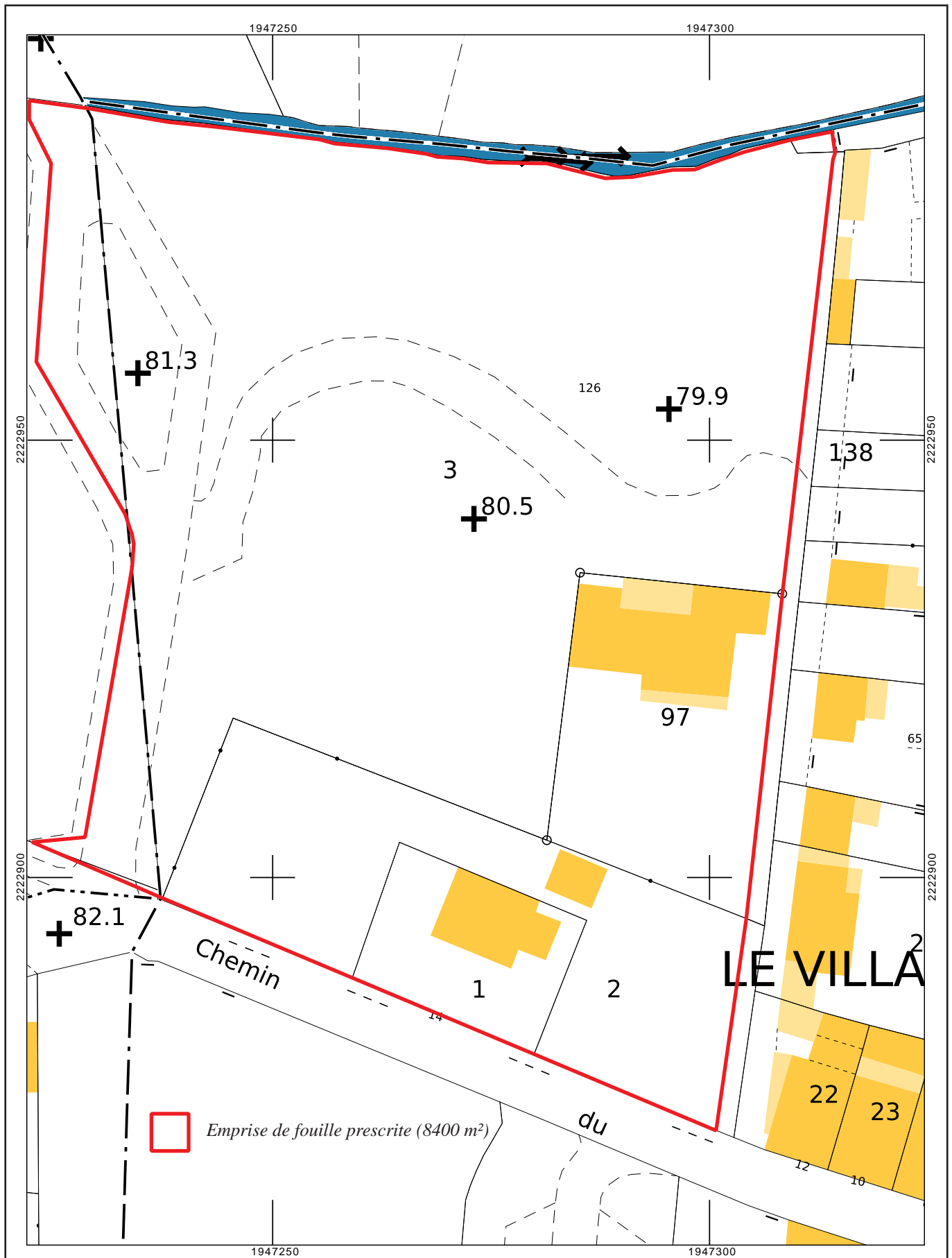
Fig. 109 : Coupes des structures en creux isolées du secteur sud-est : PO1001, FS1002, PO1003, PO1005, PO1006, PO1007, PO1133, PO1134, PO1138 et PO1139 (éch. : 1/20). (D. Baldassari, J. Grasso).

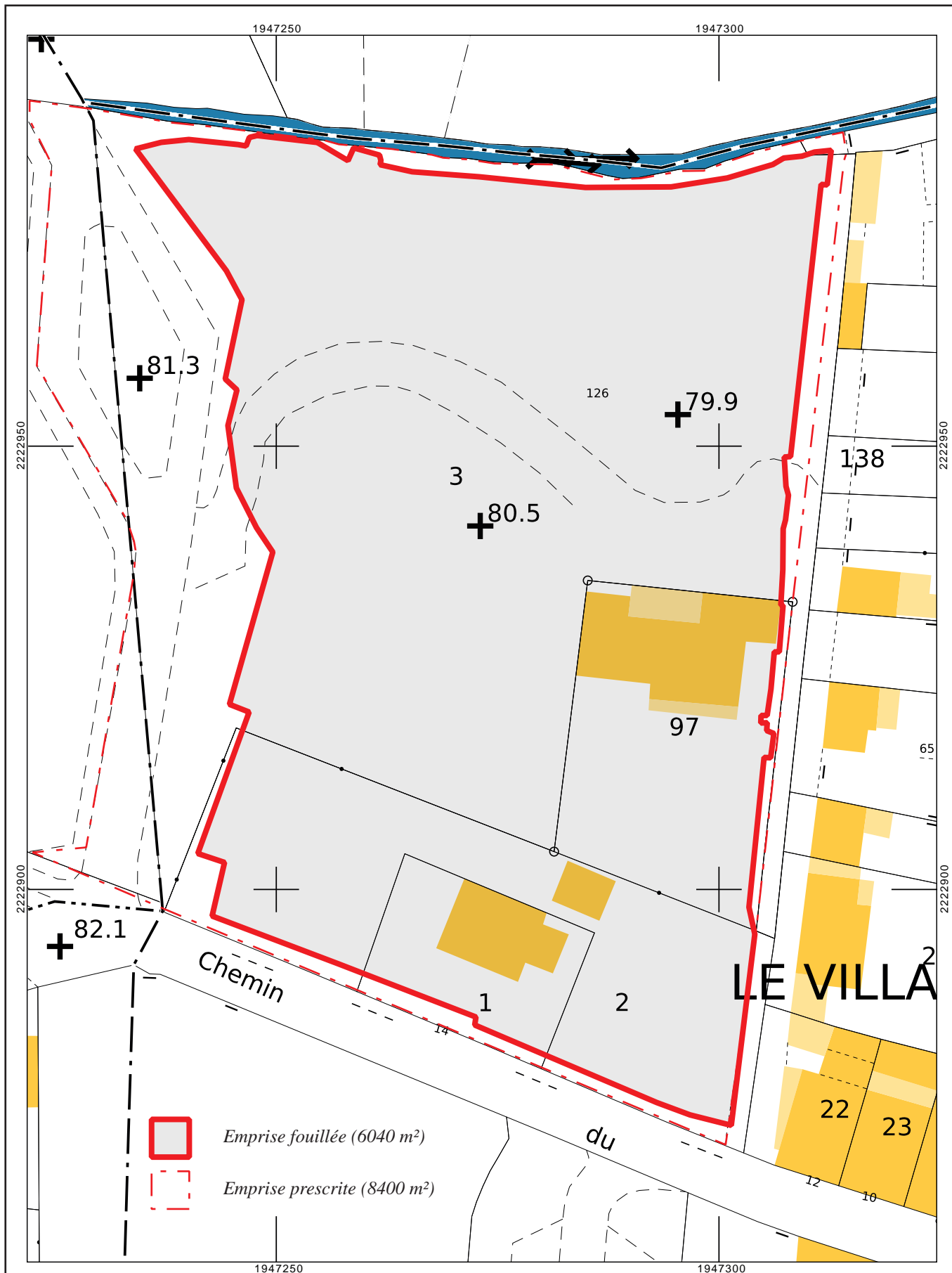
Fig. 110 : Coupes des structures en creux isolées du secteur sud-est : FS2044, FS2049, FS2050 et FS2051 (éch. : 1/20). (D. Baldassari, J. Grasso).

FIGURES











Localisation du site



Epandages de cailloutis de piedmont (Würm)



Alluvions de la basse terrasse : Würm récent



Permien : Arkose, grès et pélites



"Trias inférieur : ""Grès bigarré"" et conglomérats"



Trias - Trias moyen : calcaires et dolomies



Hettangien : Calcaires et dolomies




Bajocien inférieur calcaire - Lias supérieur et moyen



Bajocien - Bathonien marneux



 *Emprise de fouille*



La Farlède, «Projet de centralité»



Autres sites antiques



Sites mentionnés dans le texte (§ 1.1.2.)



Limites communales

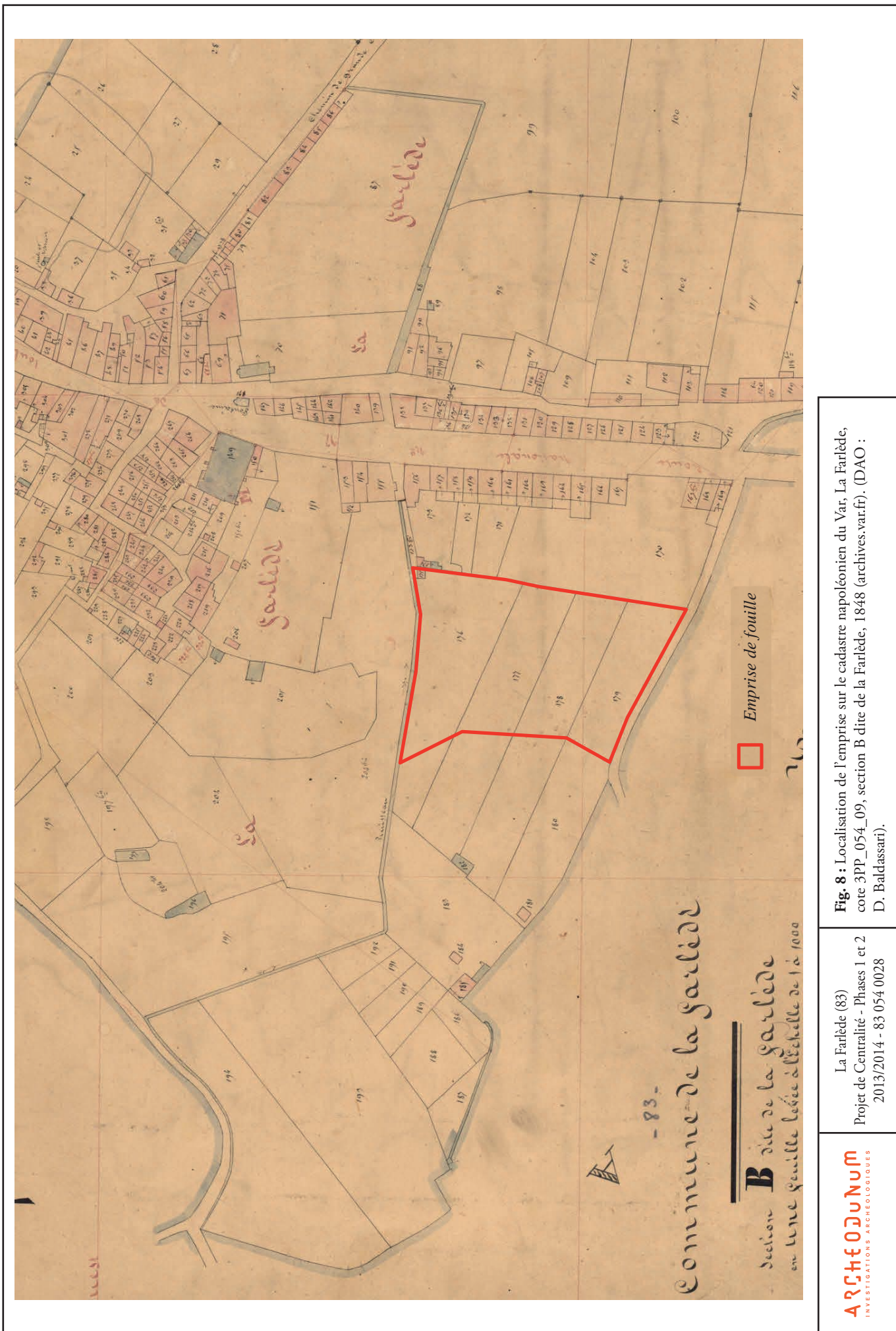
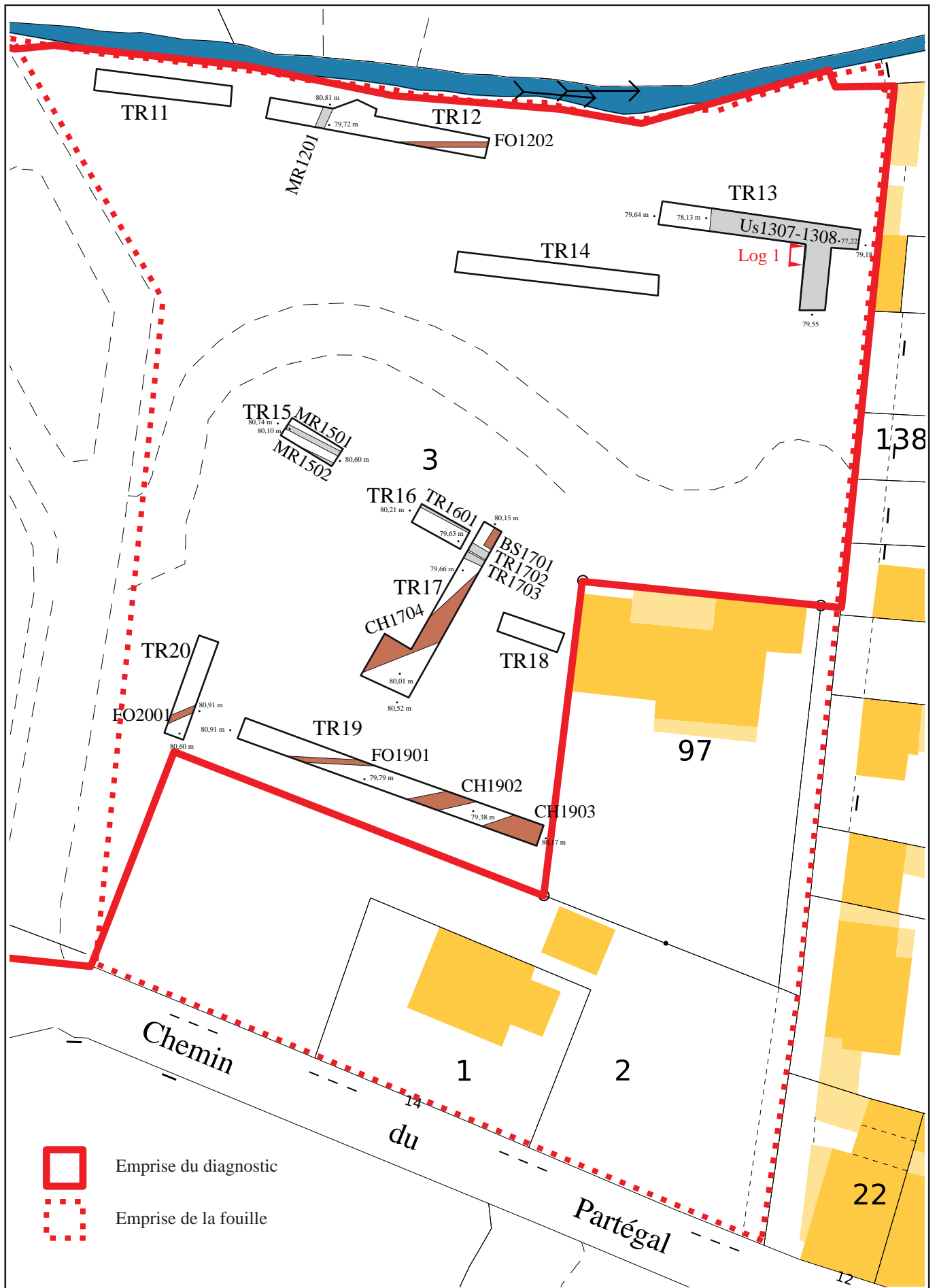


Fig. 8 : Localisation de l'emprise sur le cadastre napoléonien du Var, La Farlède, cote 3PP_054_09, section B dite de la Farlède, 1848 (archives.var.fr). (DAO : D. Baldassari).

La Farlède (83)
 Projet de Centralité - Phases 1 et 2
 2013/2014 - 83 054 0028



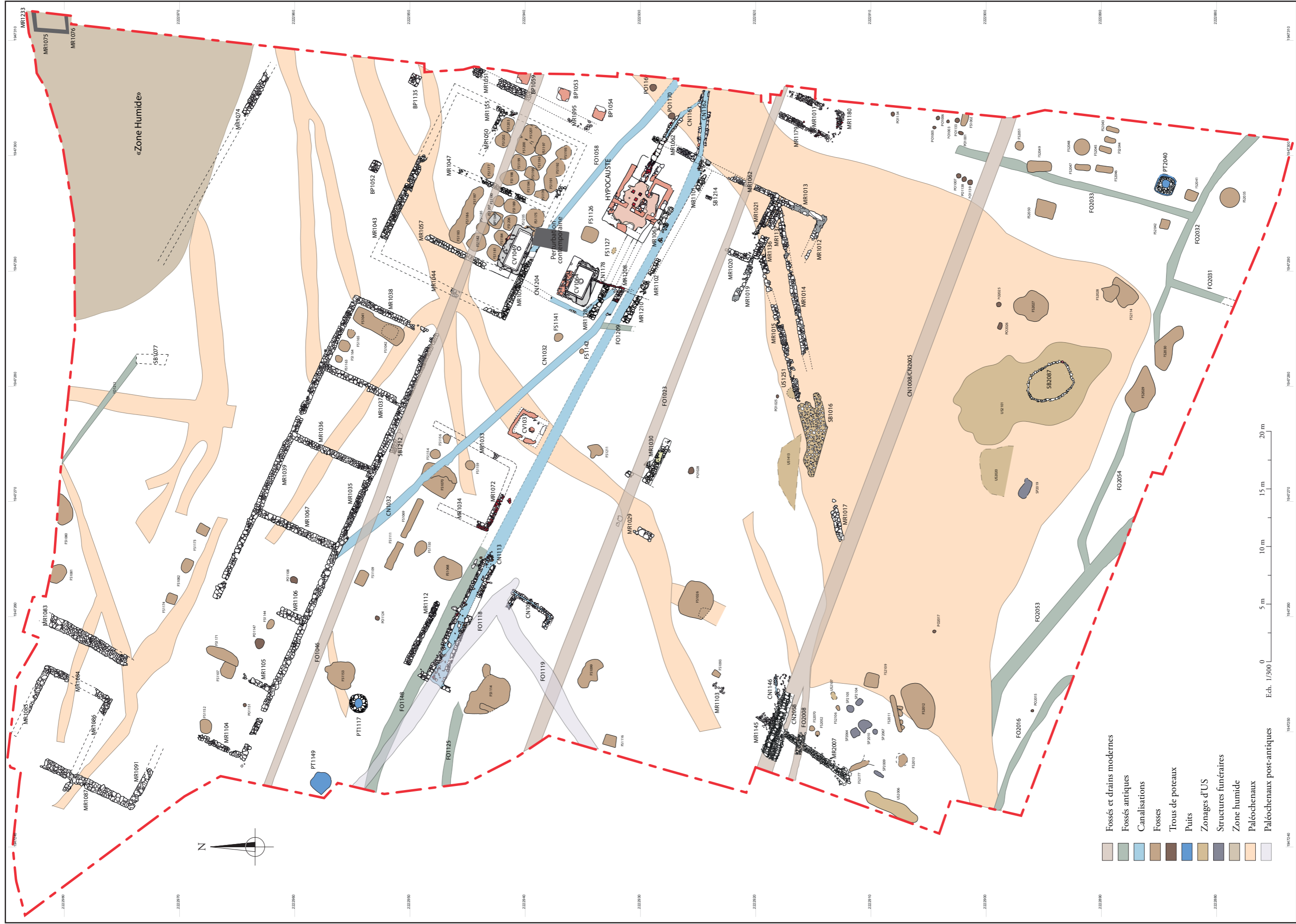
Emprise du diagnostic

Emprise de la fouille









- Fossés et drains modernes
- Fossés antiques
- Canalisations
- Fosses
- Trous de poteaux
- Puits
- Zonages d'US
- Structures funéraires
- Zone humide
- Paléochenaux
- Paléochenaux post-antiques



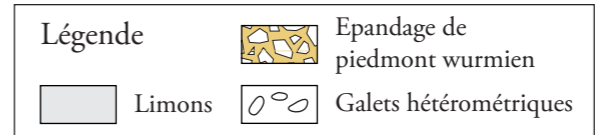
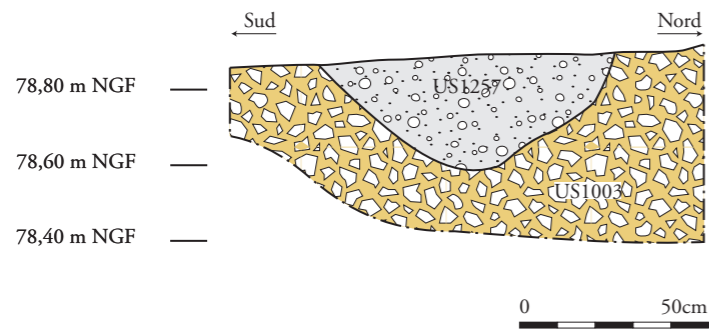
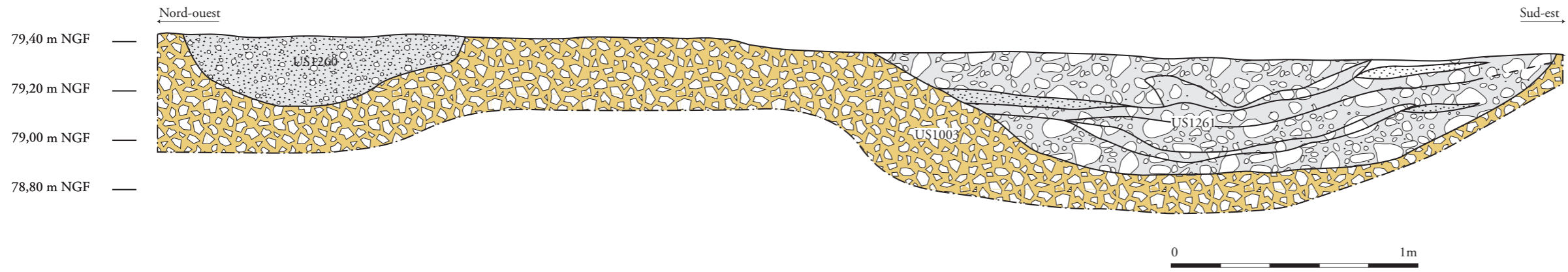
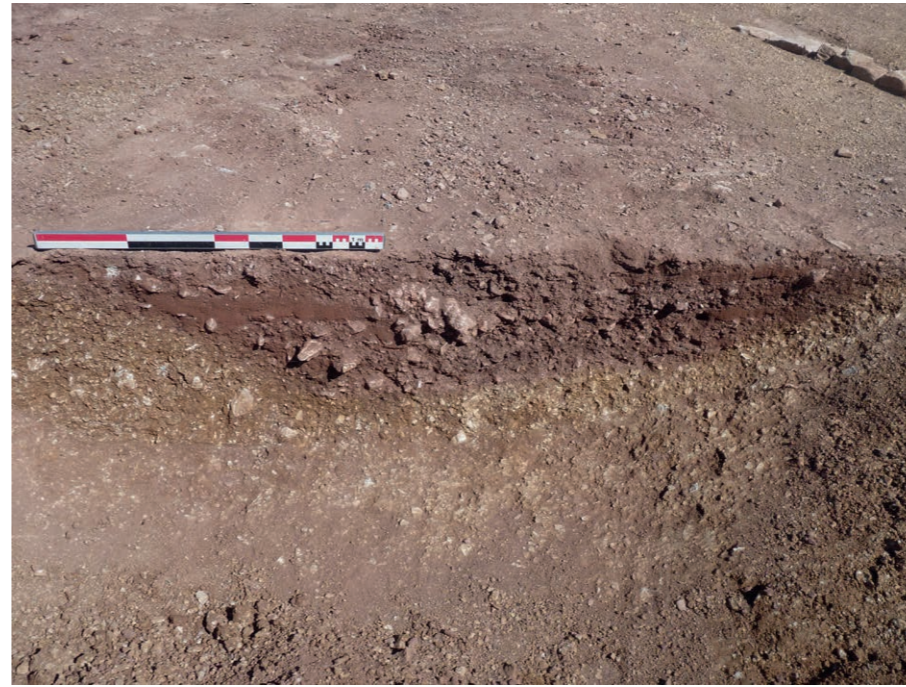
Fig. 16 : Plan des vestiges de la Phase 3 : vestiges antiques qui ne peuvent être rattachés à la Phase 1 ou à la Phase 2 (éch. : 1/300).
 (DAO : D. Baldassari, J. Grasso).

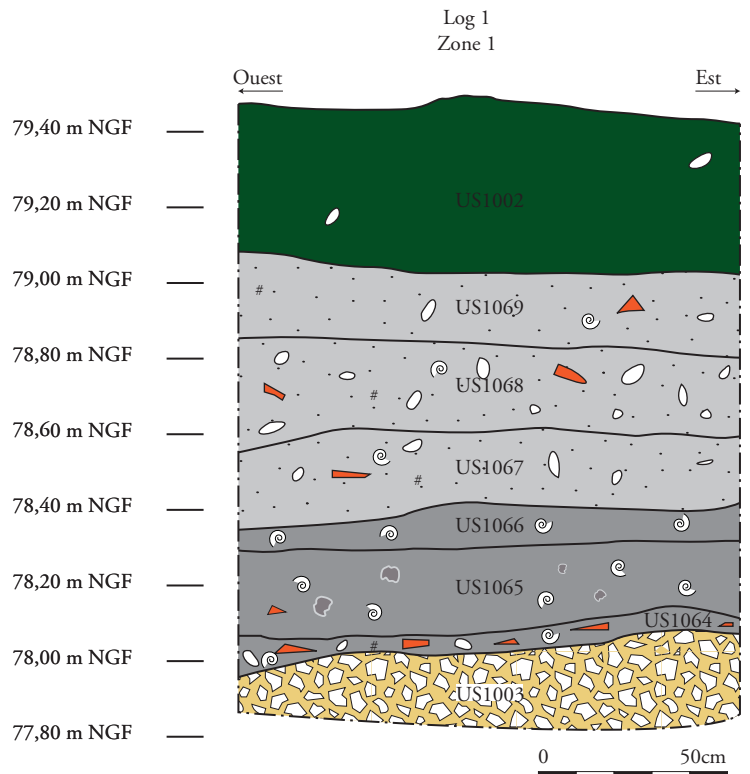
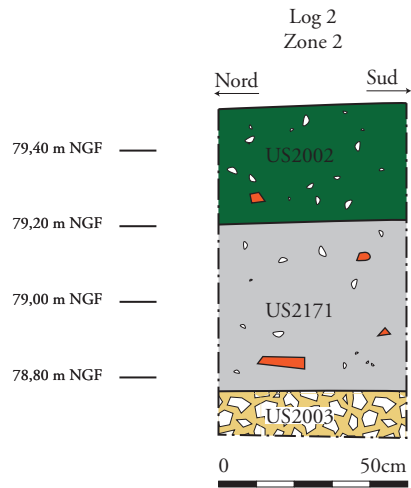
La Farliède (83)
 Projet de Centralité - Phases 1 et 2
 2013/2014 - 83 054 0028



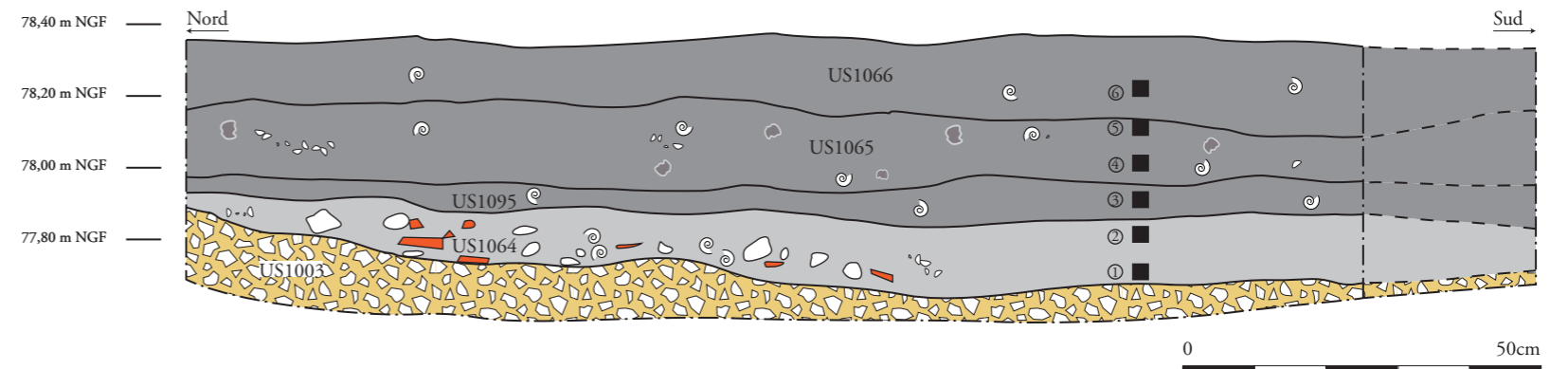
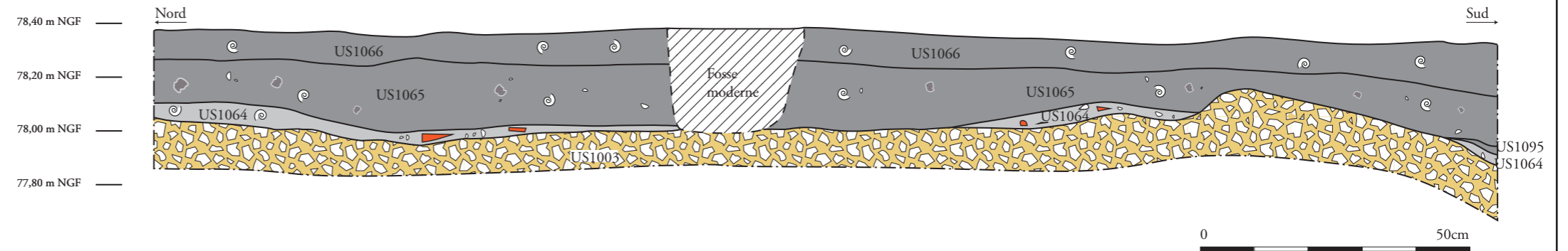


Fig. 20 : Plan des Ensembles et des Entités (éch. : 1/300). (DAO : D. Baldassari, J. Grasso).

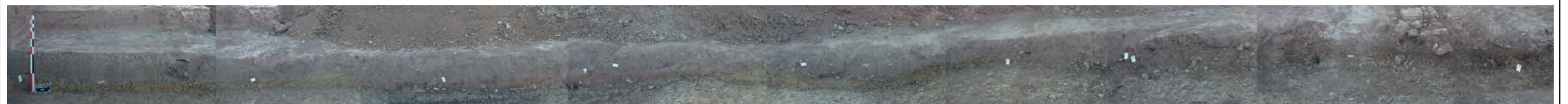
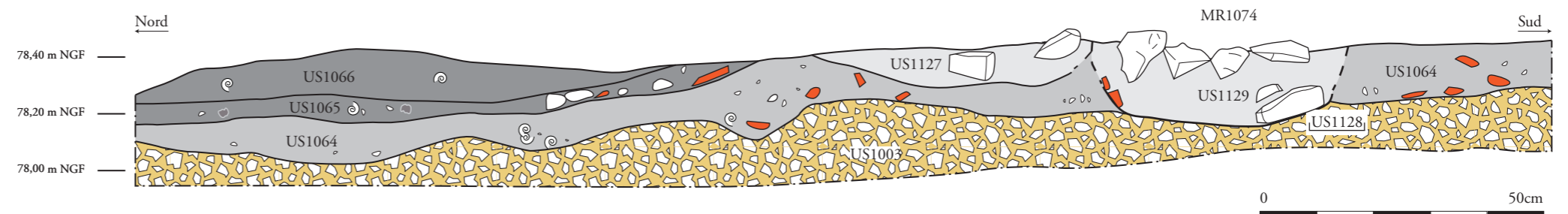
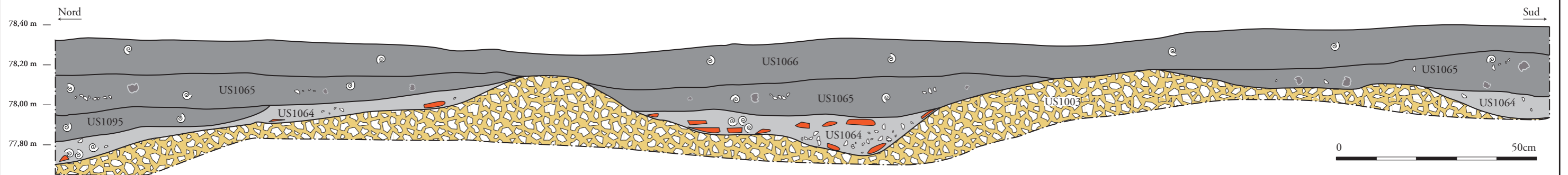




	Sables		Epandage de piedmont wurmien		Malacofaune		Sol actuel
	Limons/argiles		Gravier		Charbons		
	Argiles		Oxydo-réduction		Céramiques		



Légende					
	Limons/argiles		Epandage de piedmont wurmien		Malacofaune
	Argiles		Graviers		Céramiques
			Oxydo-réduction		Prélèvements palynologiques



Légende			
	Epandage de piedmont wurmien		Manganèse
	Limons/argiles		Céramique/TCA
	Argiles		Sigillée
	Gravier		
	Sables		

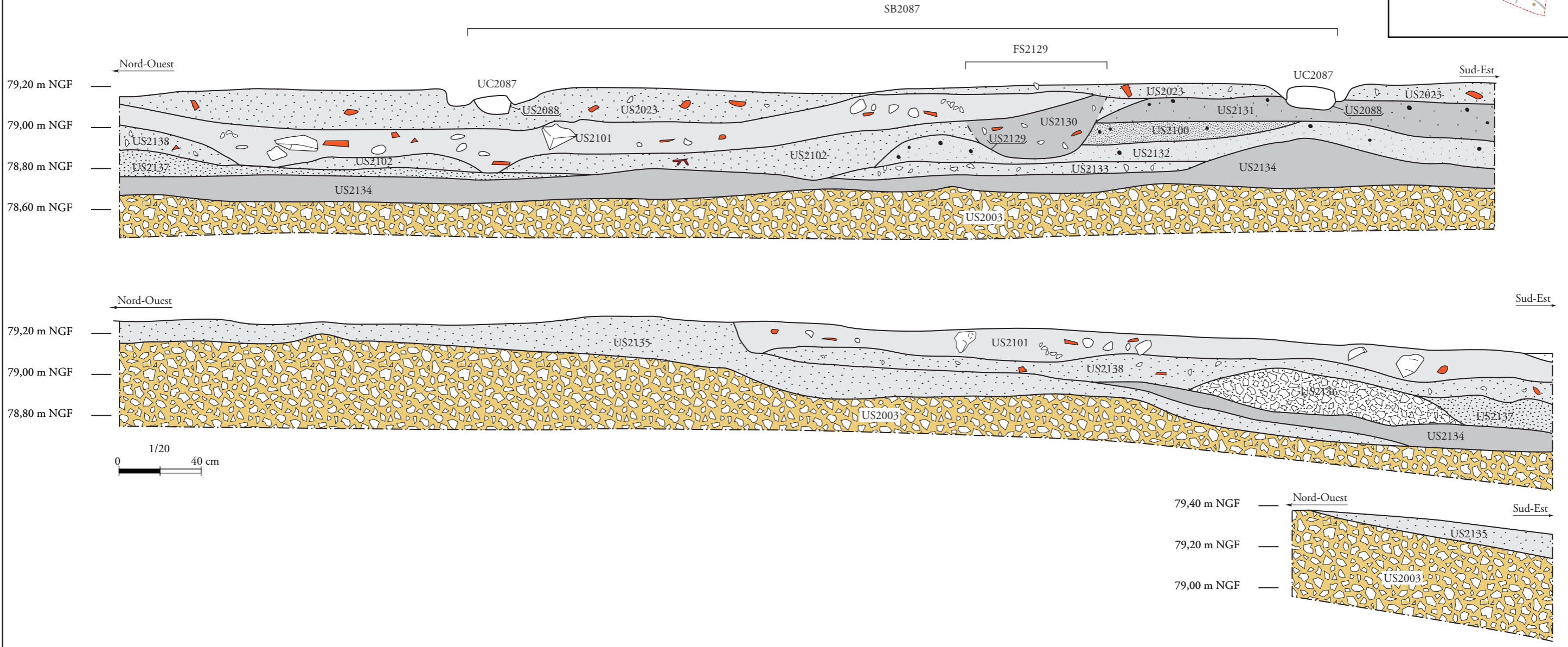


Fig. 25 : TRG 2001 (éch. : 1/20). (DAO : C. Faisse).

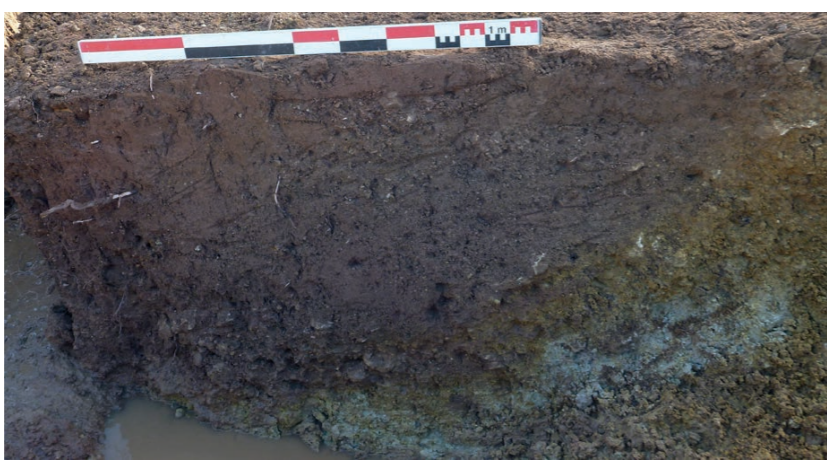
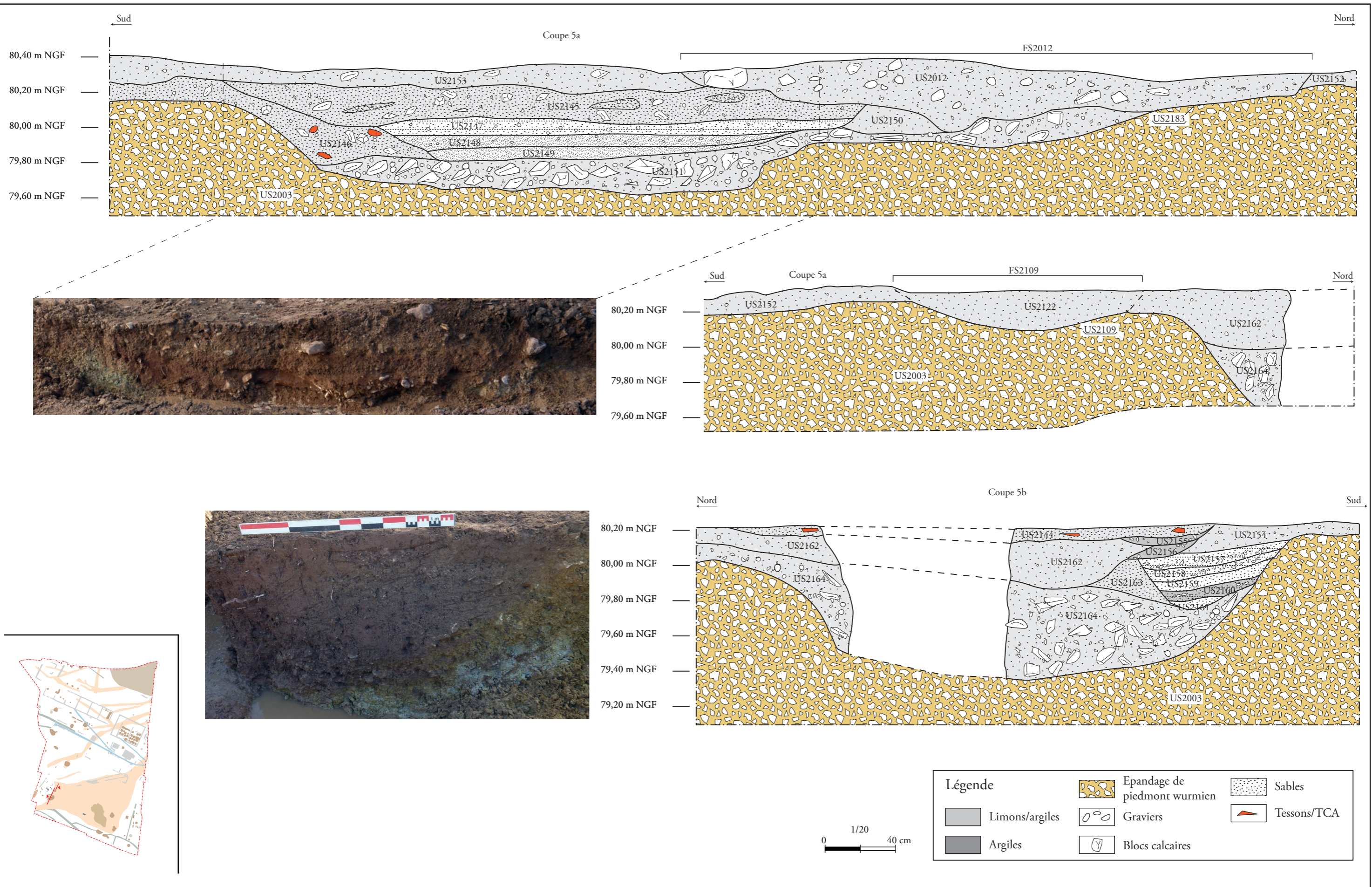
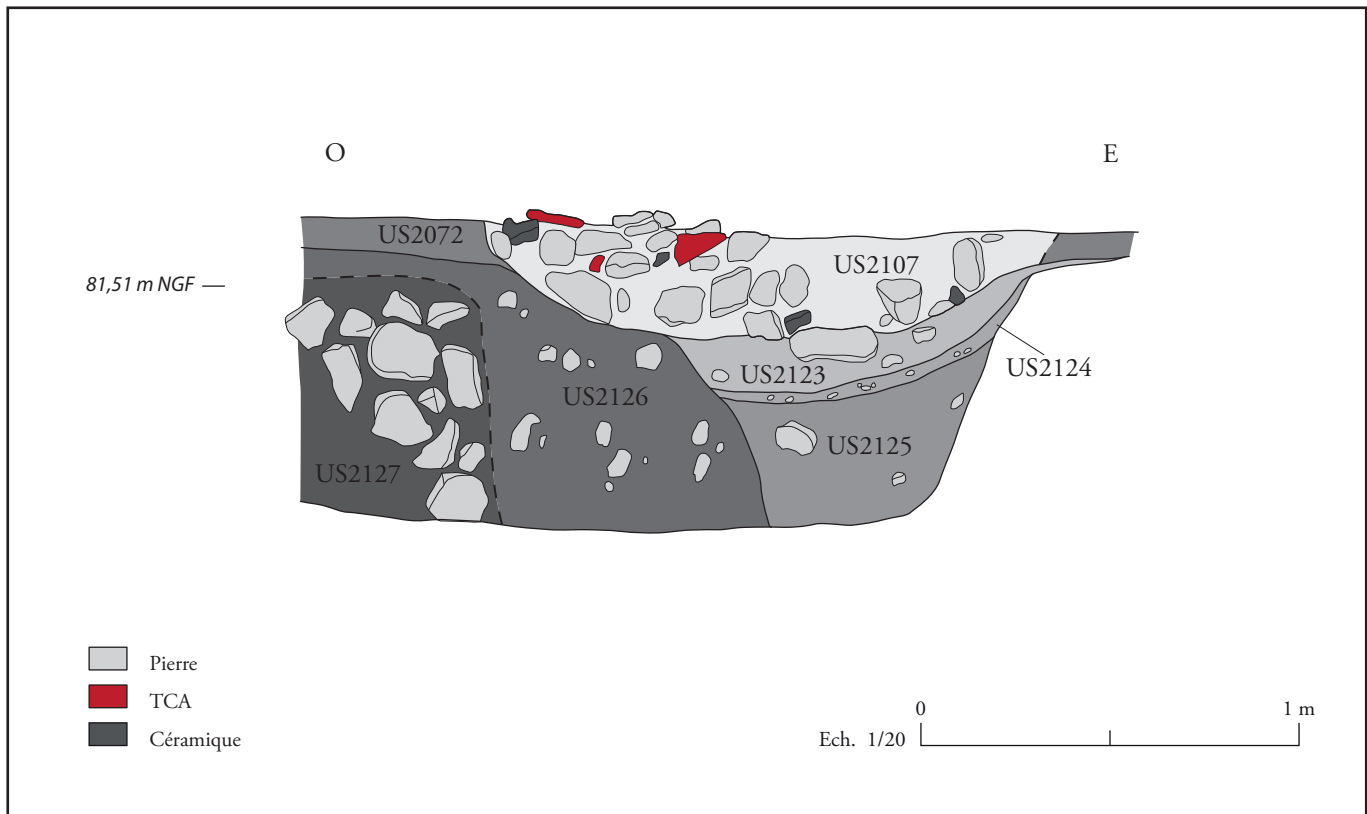


Fig. 26 : TRG 2002 (éch. : 1/20). (DAO : C. Faisse).



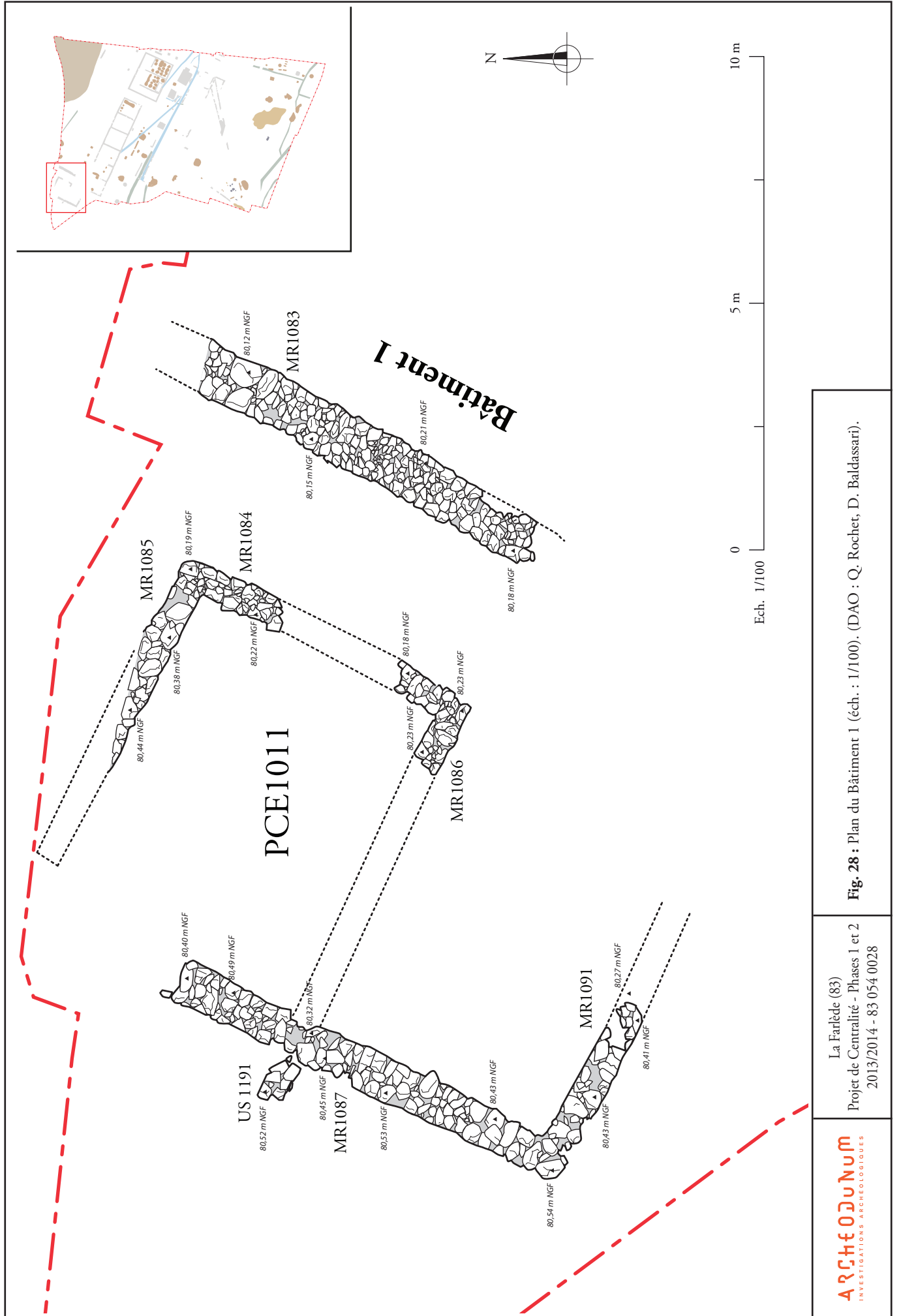


Fig. 28 : Plan du Bâtiment 1 (éch. : 1/100). (DAO : Q. Rochet, D. Baldassari).

La Farliède (83)
 Projet de Centralité - Phases 1 et 2
 2013/2014 - 83 054 0028

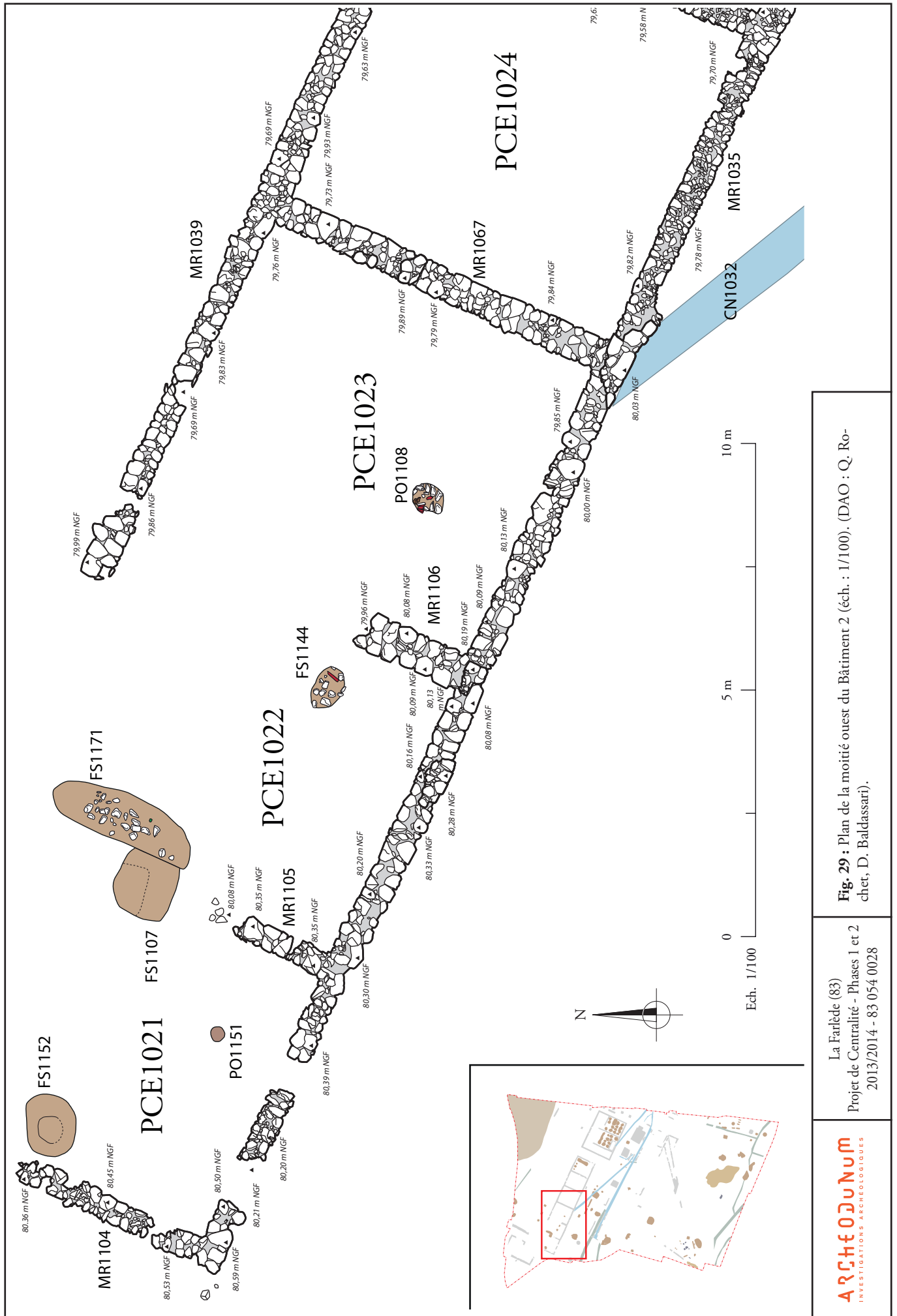
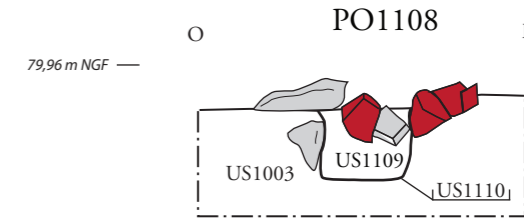
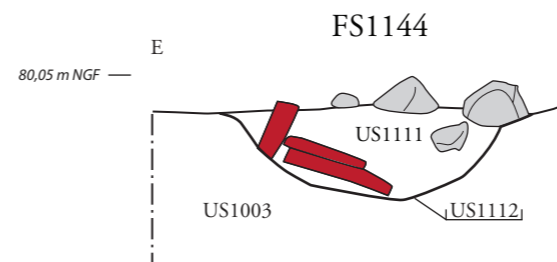
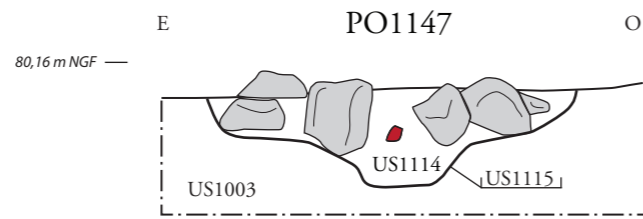
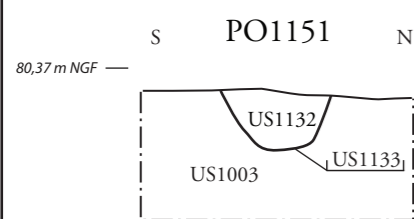
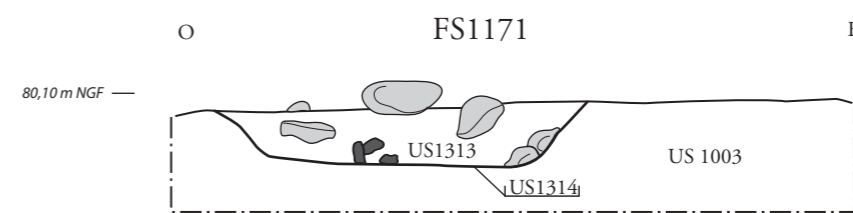
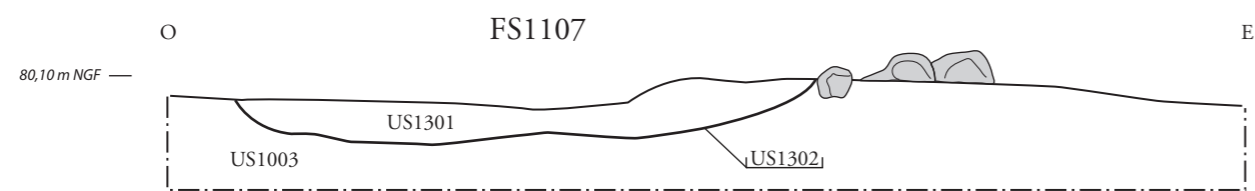
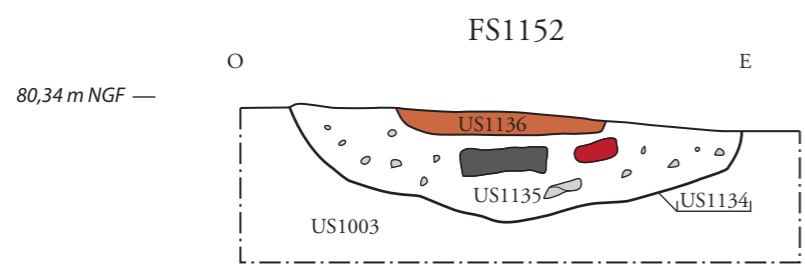
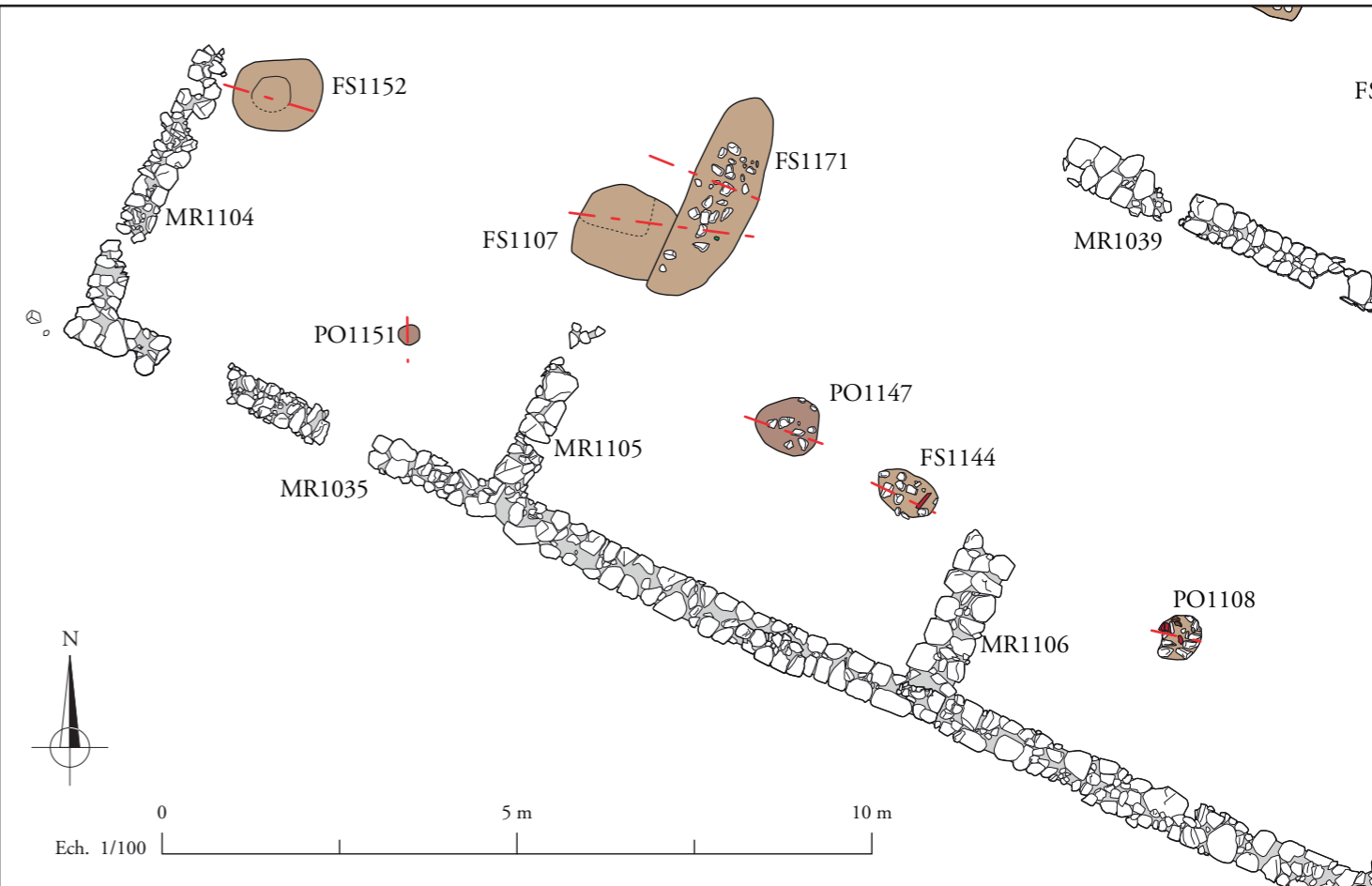
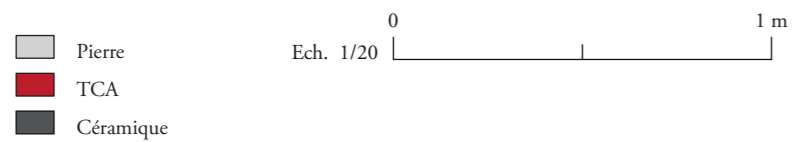


Fig. 29 : Plan de la moitié ouest du Bâtiment 2 (éch. : 1/100). (DAO : Q. Rochet, D. Baldassari).

La Farliède (83)
 Projet de Centralité - Phases 1 et 2
 2013/2014 - 83 054 0028







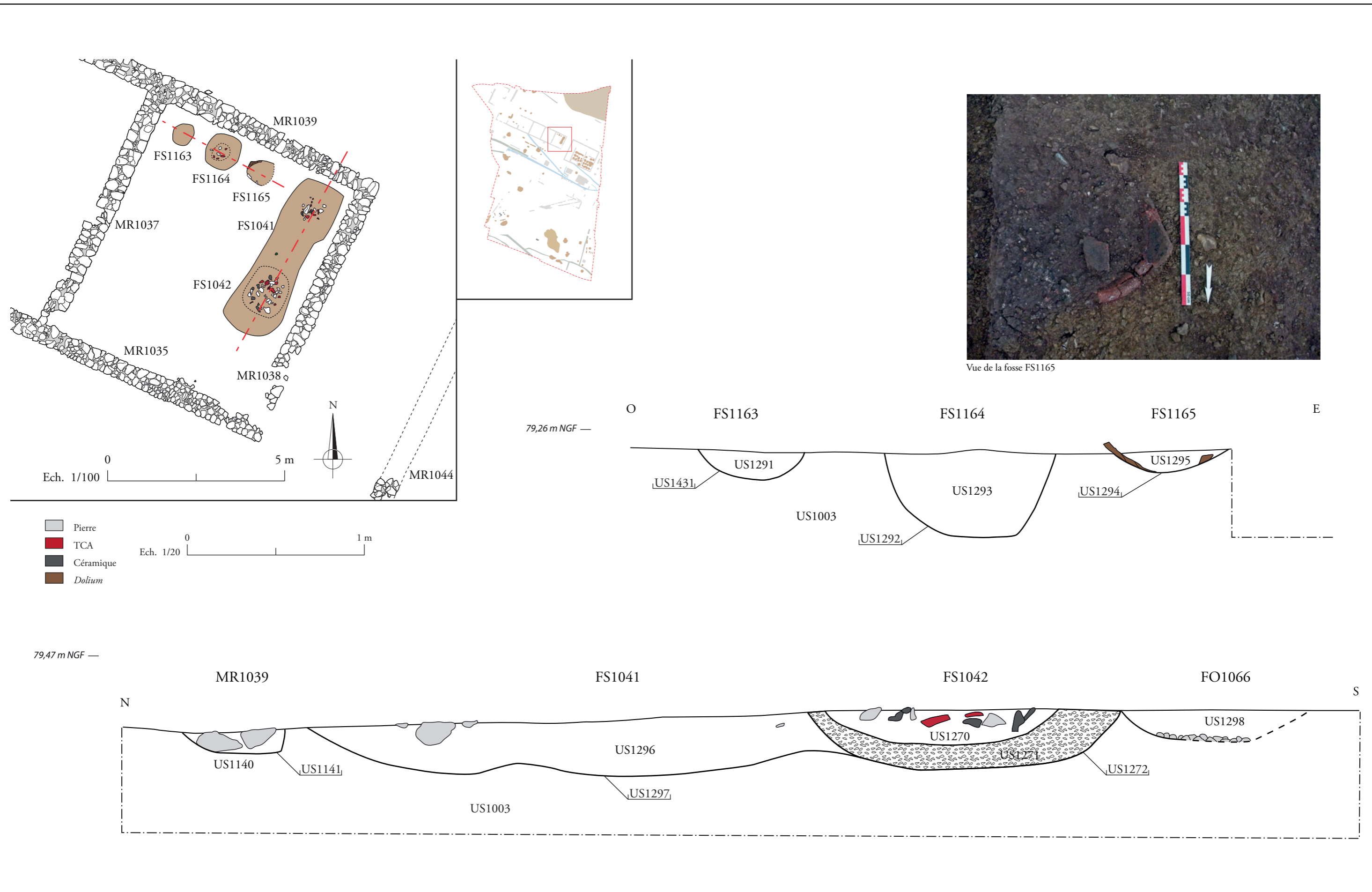
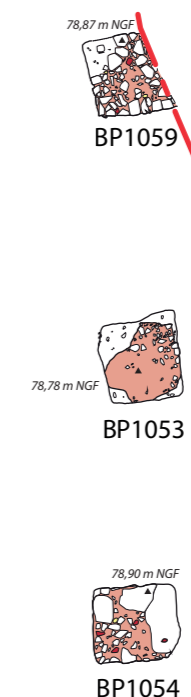
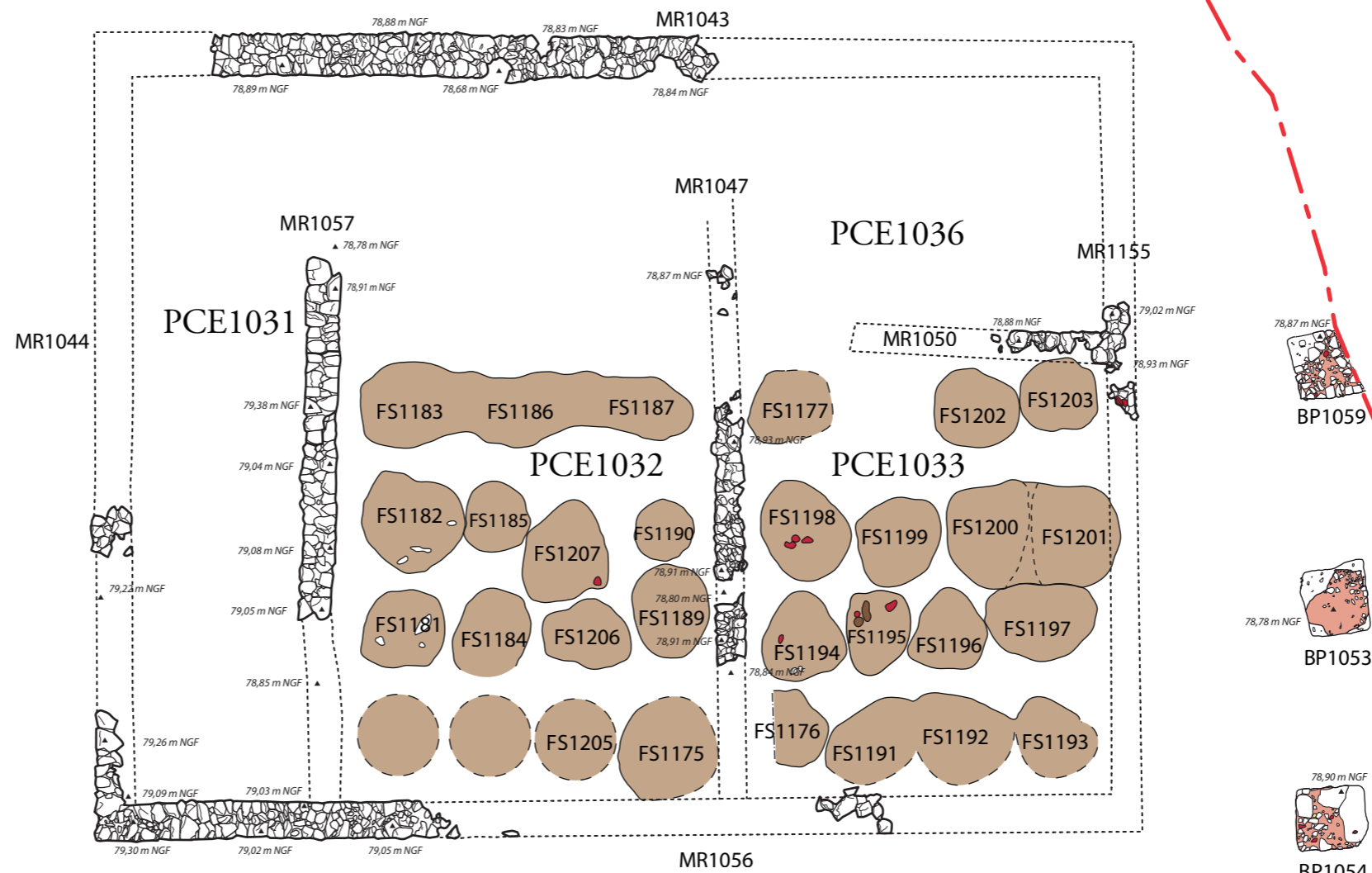
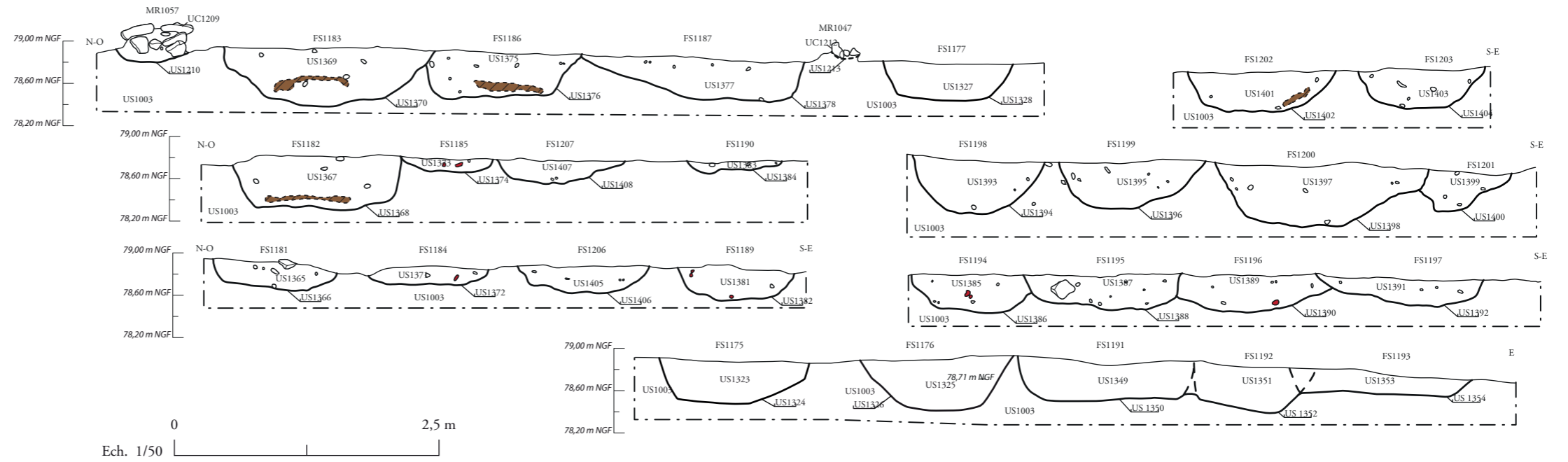
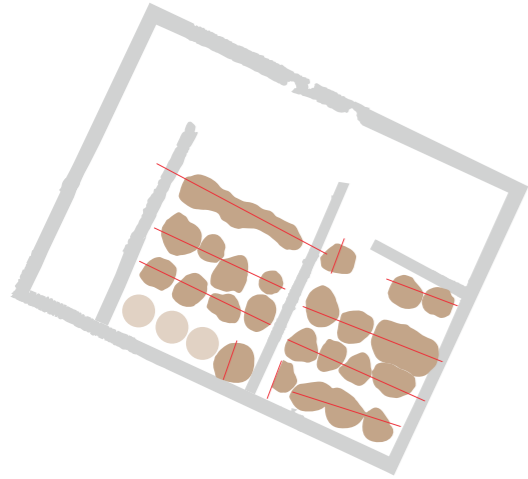


Fig. 34 : Coupes des fosses implantées dans l'espace PCE1026 : FS1041, FS1042, FS1163, FS1164 et FS1165 (éch. : 1/20). (D. Baldassari, J. Grasso).



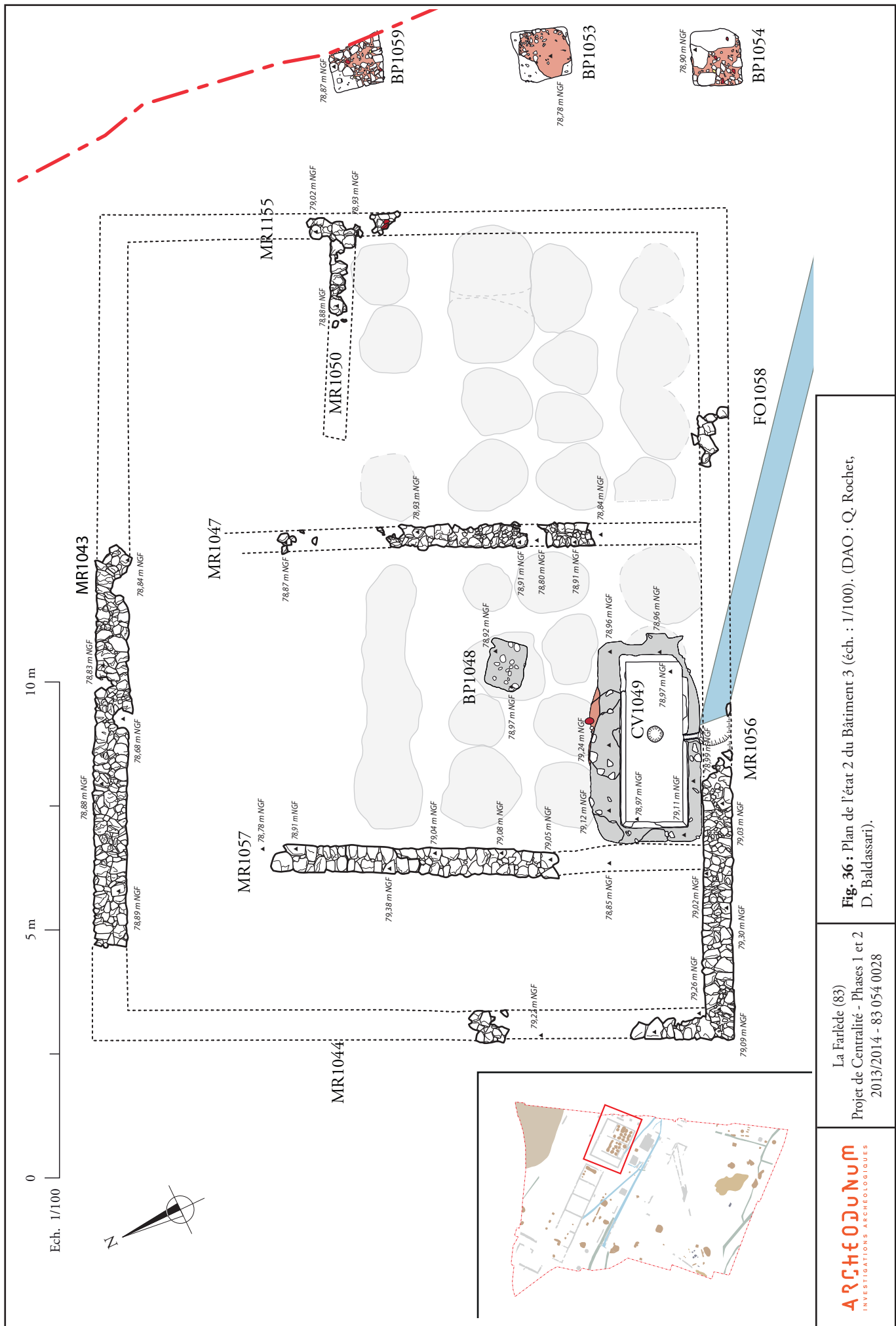


Fig. 36 : Plan de l'état 2 du Bâtiment 3 (éch. : 1/100). (DAO : Q. Rochet, D. Baldassari).

La Farliède (83)
 Projet de Centralité - Phases 1 et 2
 2013/2014 - 83 054 0028





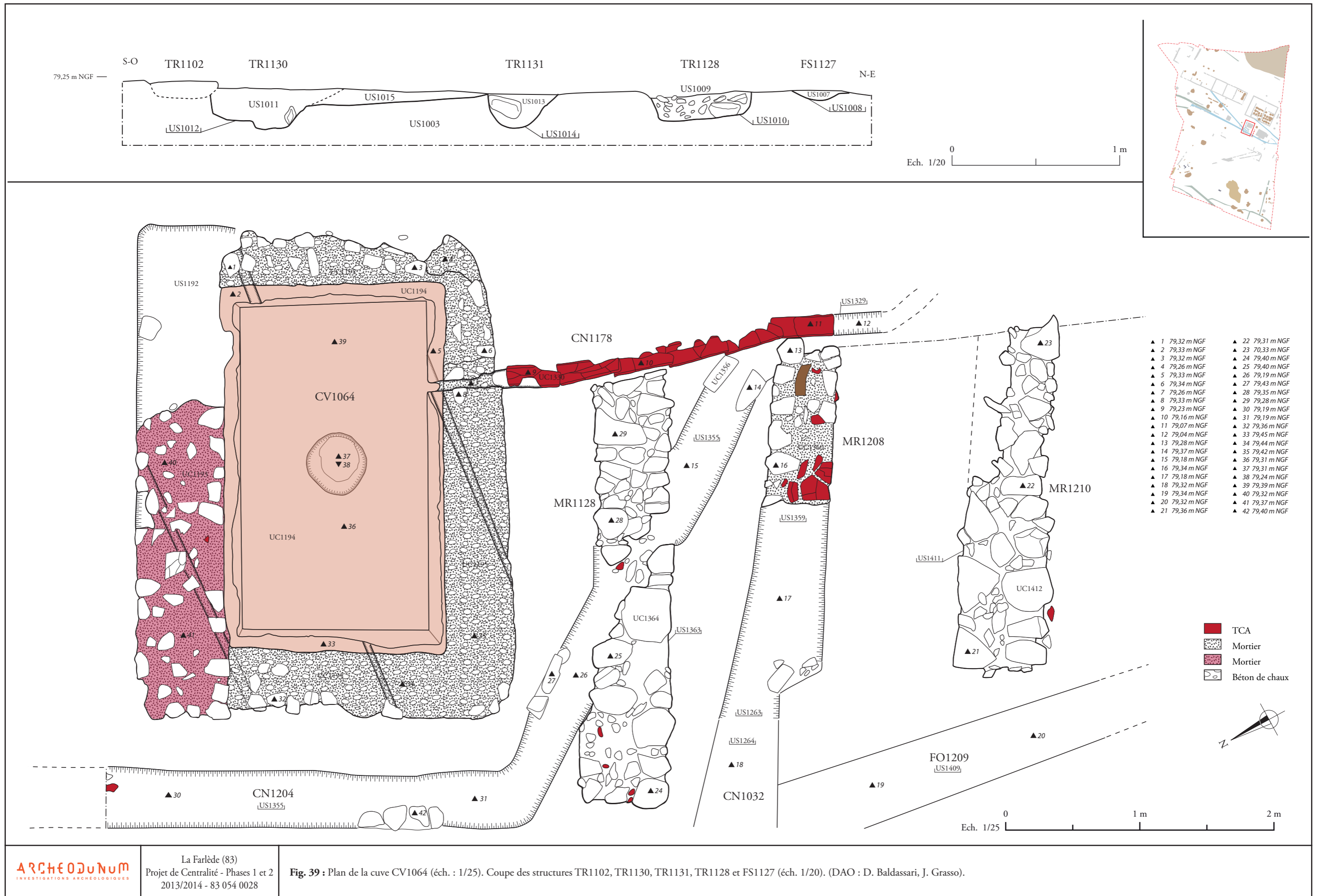


Fig. 39 : Plan de la cuve CV1064 (éch. : 1/25). Coupe des structures TR1102, TR1130, TR1131, TR1128 et FS1127 (éch. 1/20). (DAO : D. Baldassari, J. Grasso).










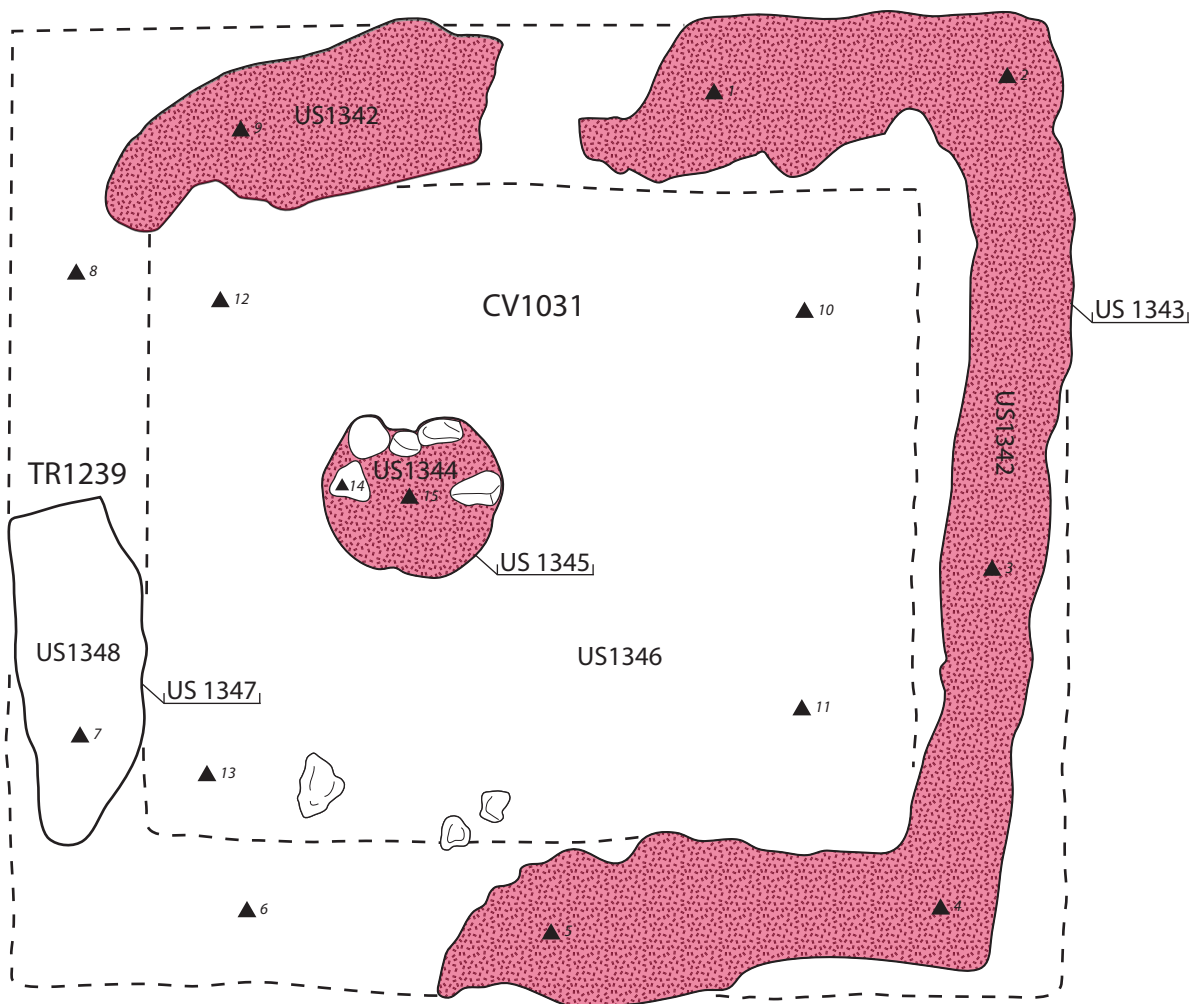
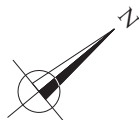


Ech. 1/20 0 1 m 2 m

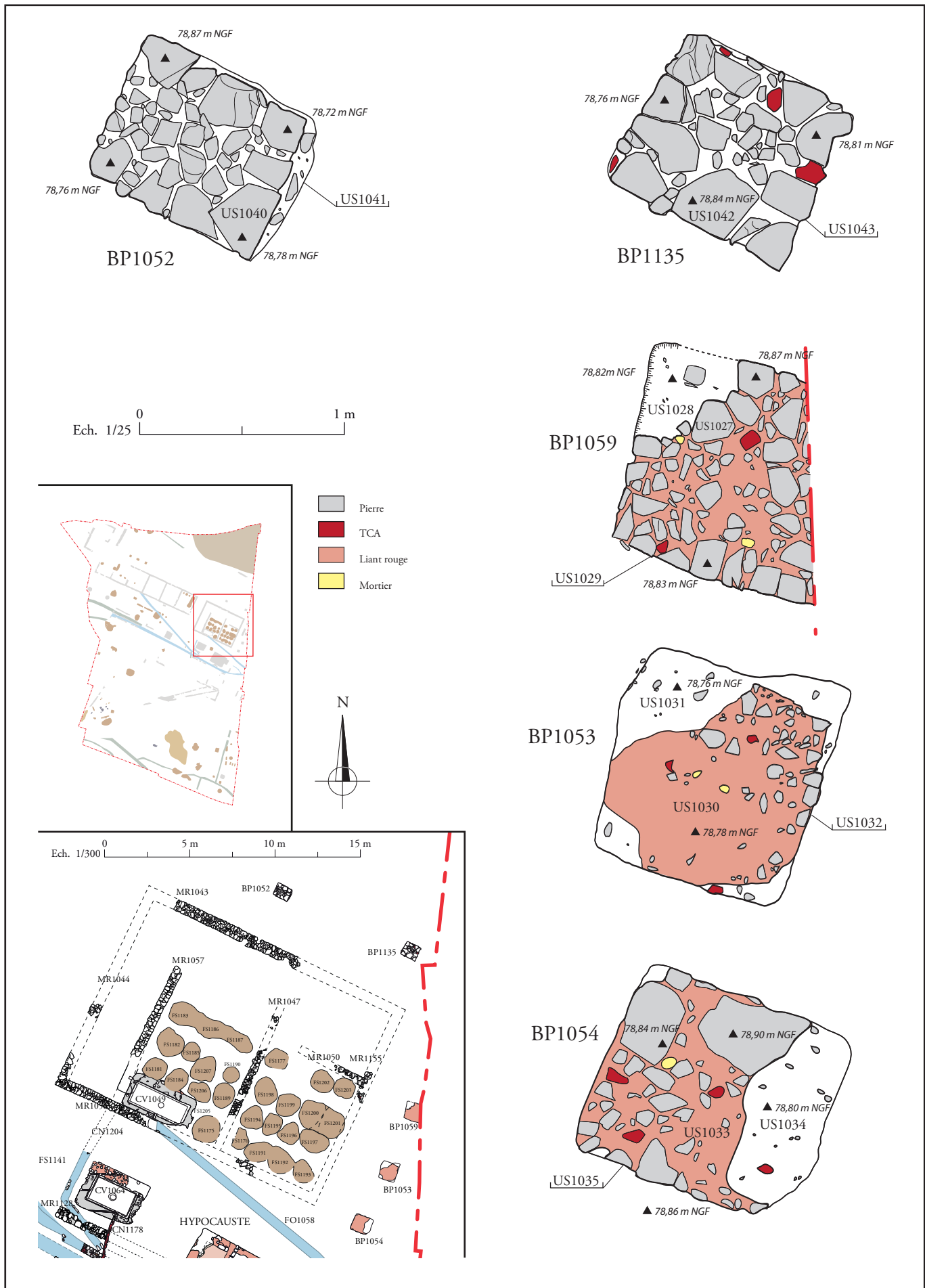
- ▲ 1 79,57 m NGF
- ▲ 2 79,61 m NGF
- ▲ 3 79,60 m NGF
- ▲ 4 79,50 m NGF
- ▲ 5 79,50 m NGF
- ▲ 6 79,51 m NGF
- ▲ 7 79,49 m NGF
- ▲ 8 79,57 m NGF

- ▲ 9 79,57 m NGF
- ▲ 10 79,53 m NGF
- ▲ 11 79,50 m NGF
- ▲ 12 79,54 m NGF
- ▲ 13 79,53 m NGF
- ▲ 14 79,55 m NGF
- ▲ 15 79,46 m NGF

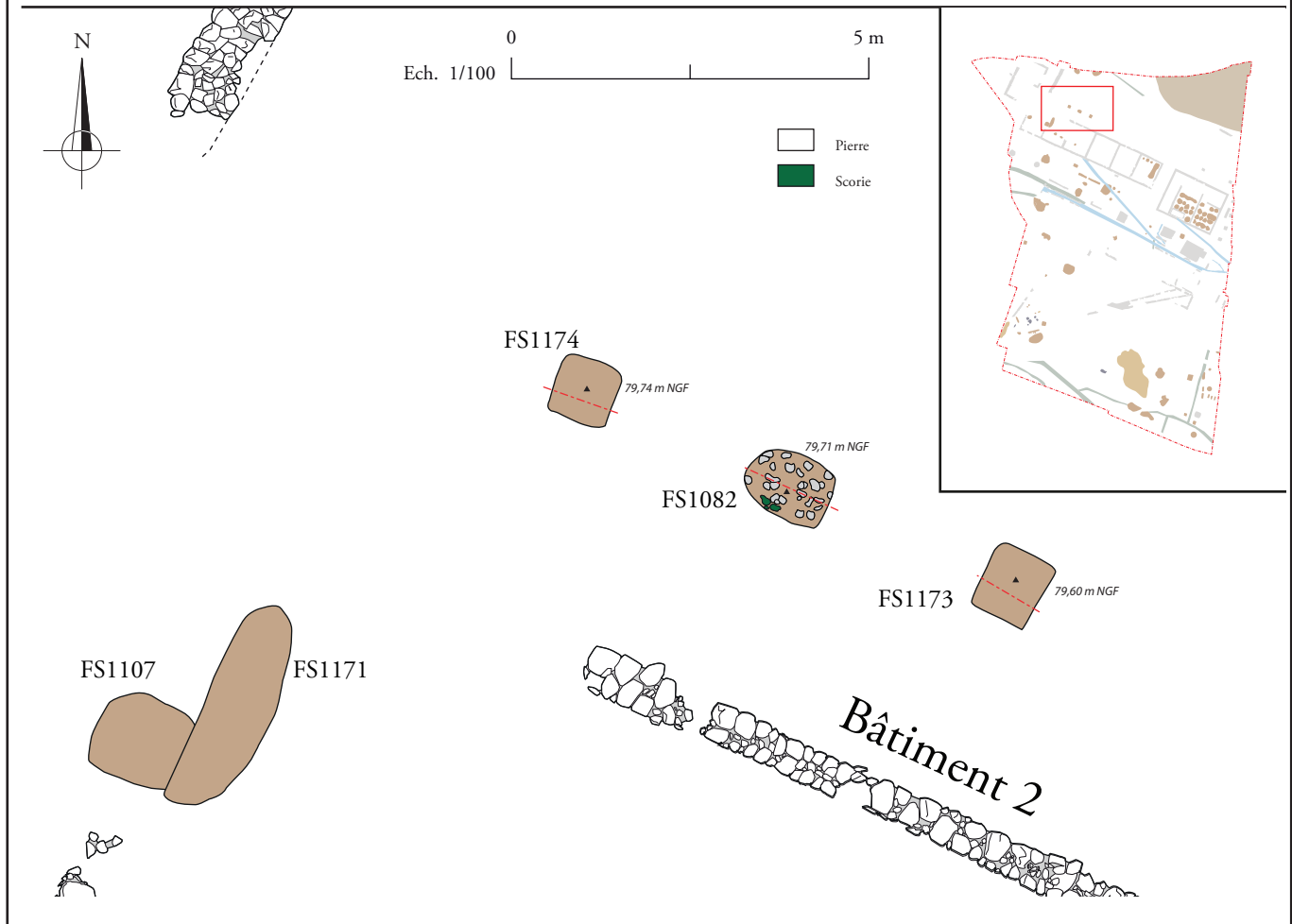
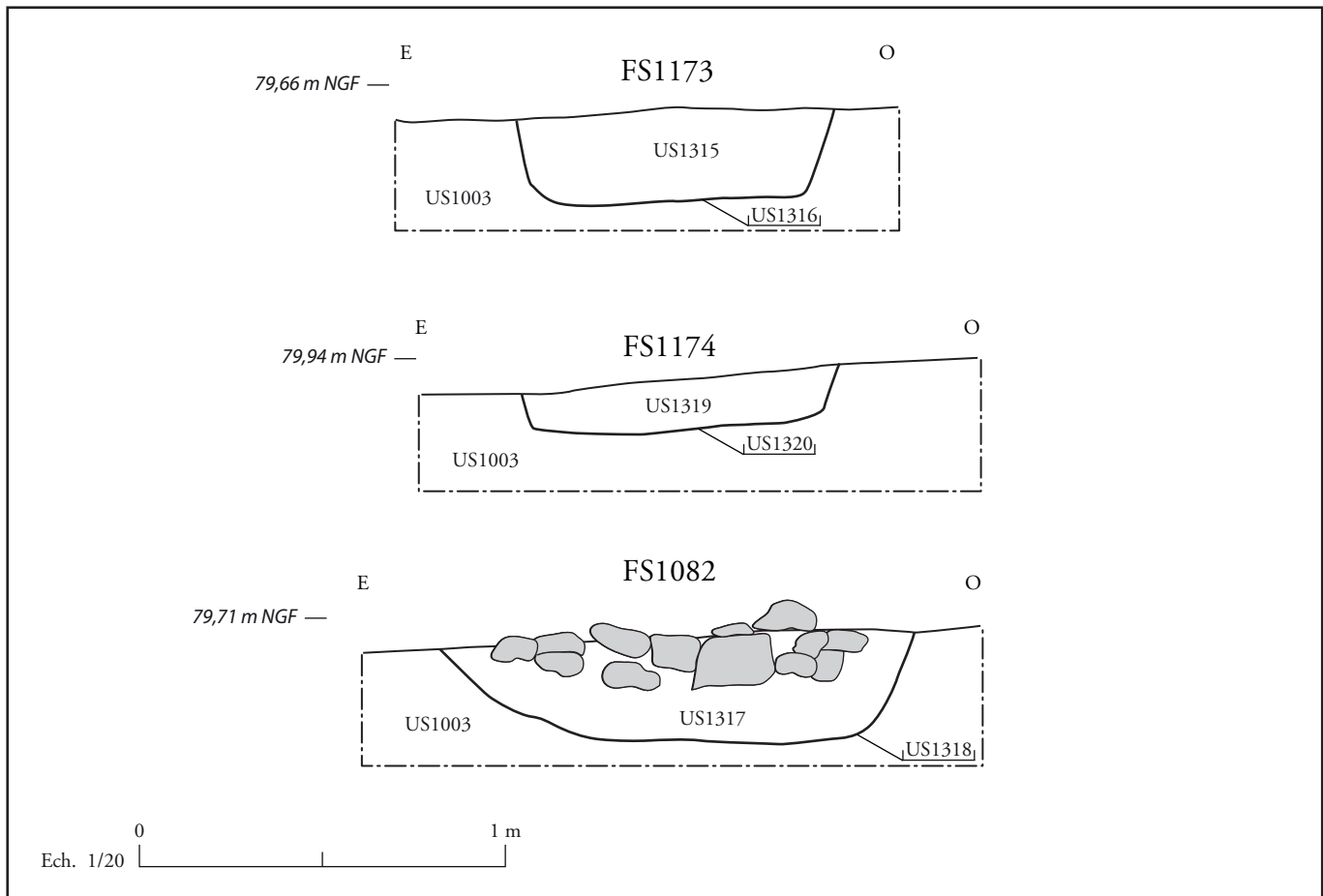
 Mortier de tuileau

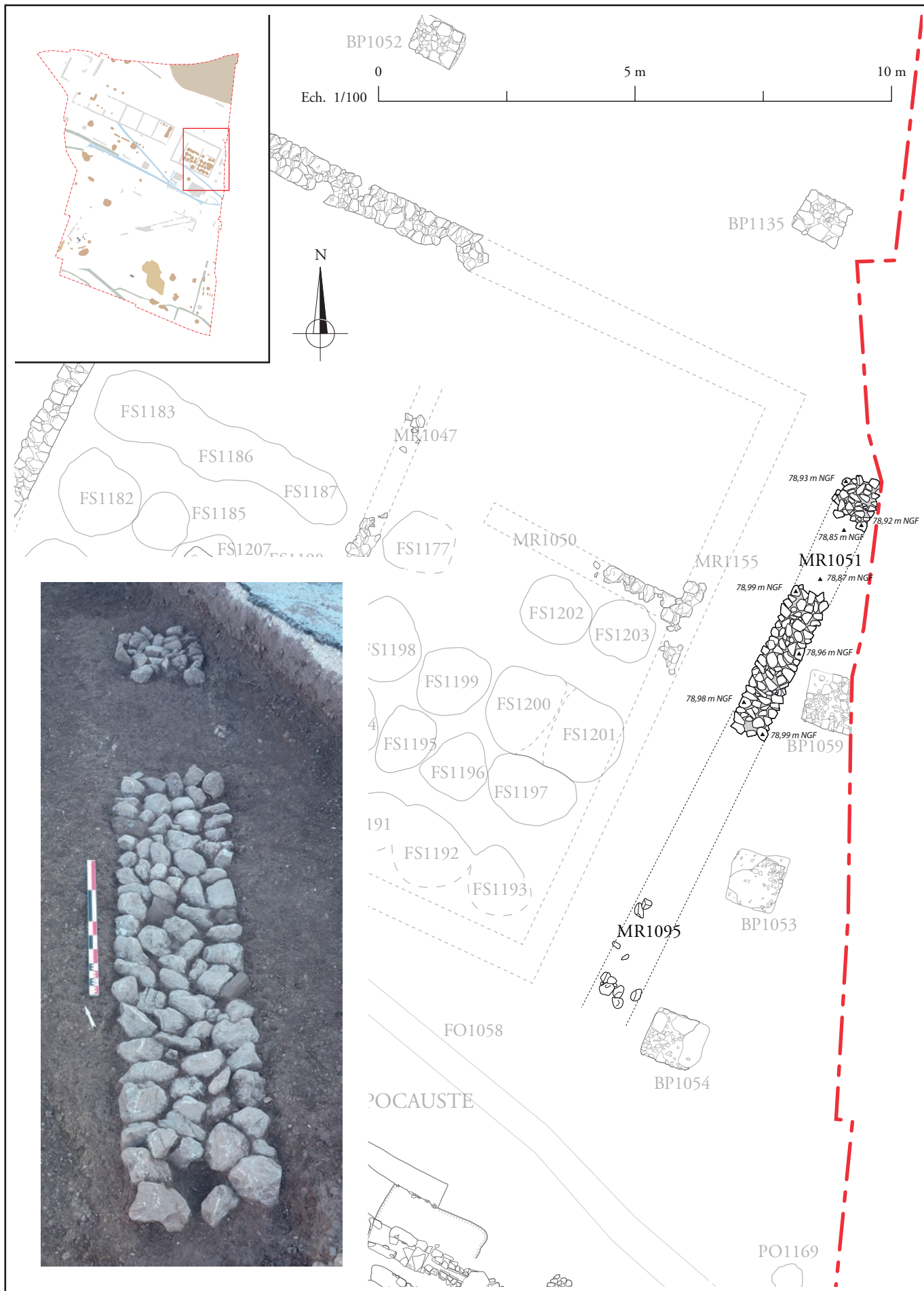


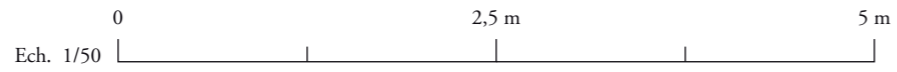




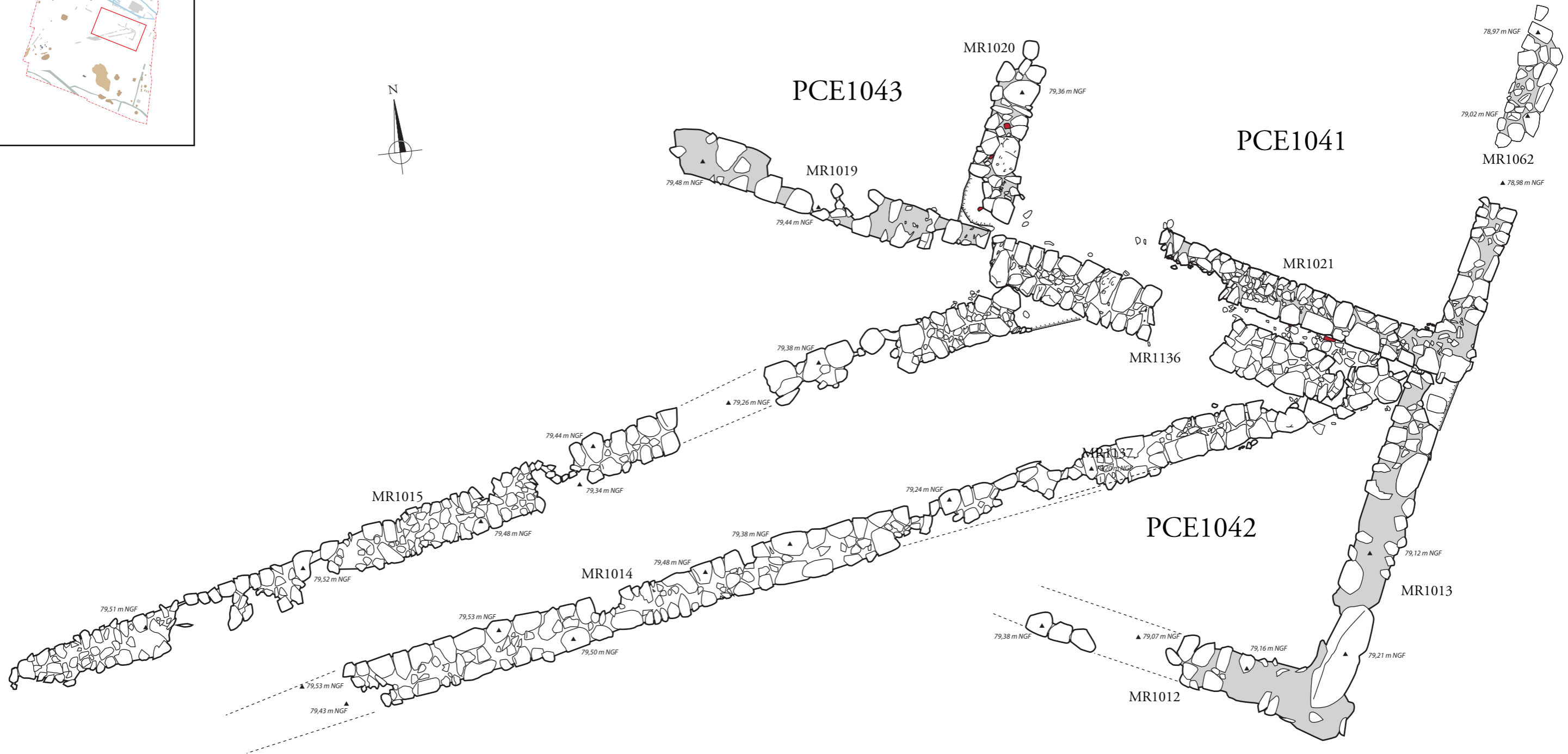








Bâtiment 4





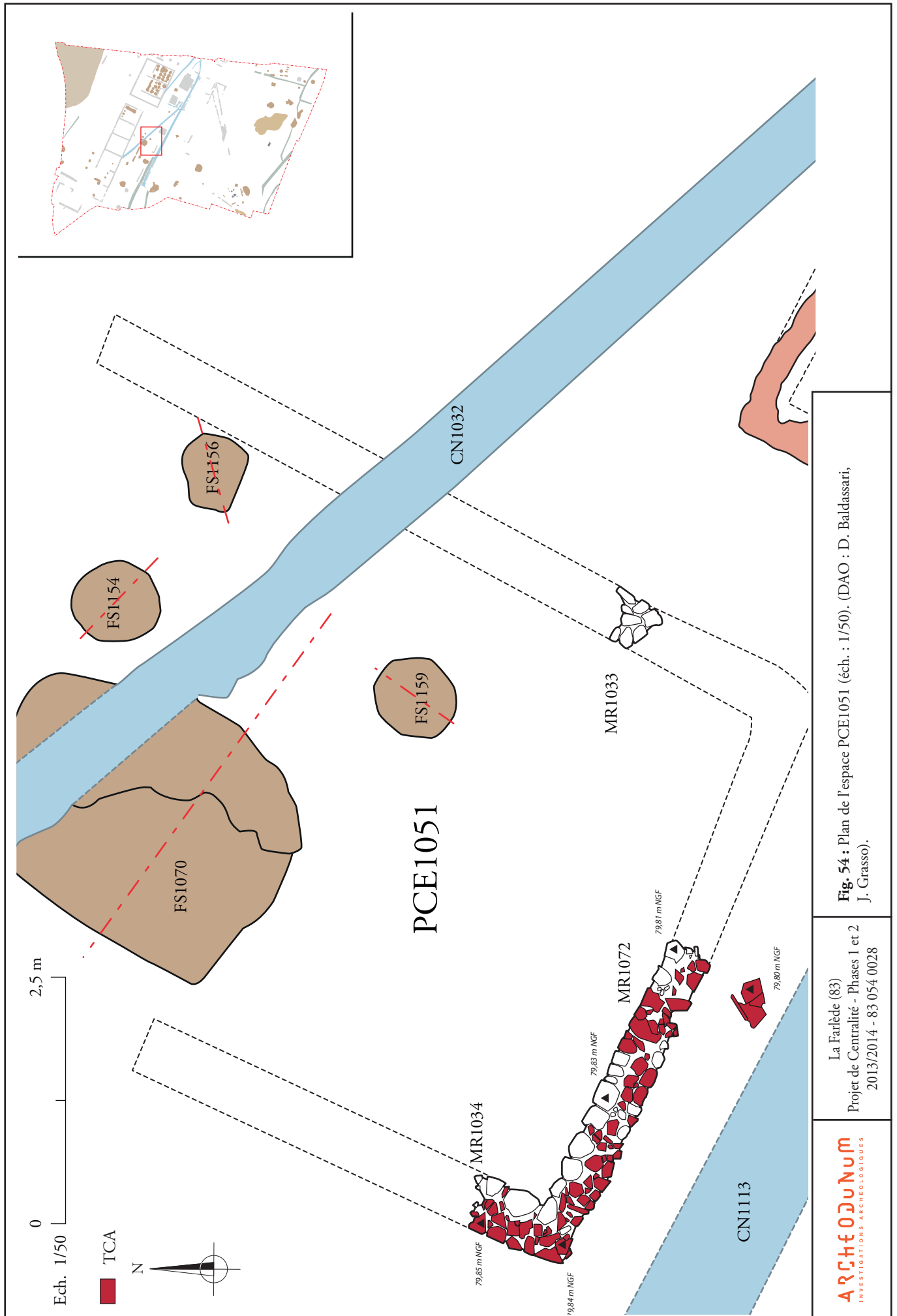


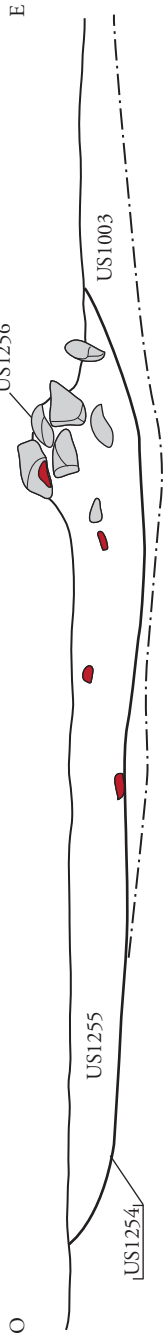
Fig. 54 : Plan de l'espace PCE1051 (éch. : 1/50). (DAO : D. Baldassari, J. Grasso).

La Farlède (83)
 Projet de Centralité - Phases 1 et 2
 2013/2014 - 83 054 0028



79,98 m NGF —

FS1070



FS1154

FS1156

79,70 m NGF —

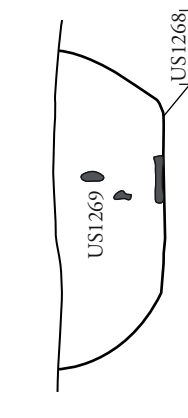
79,66 m NGF —



FS1159

FS1156

79,62 m NGF —



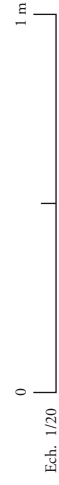
Pierre



TCA

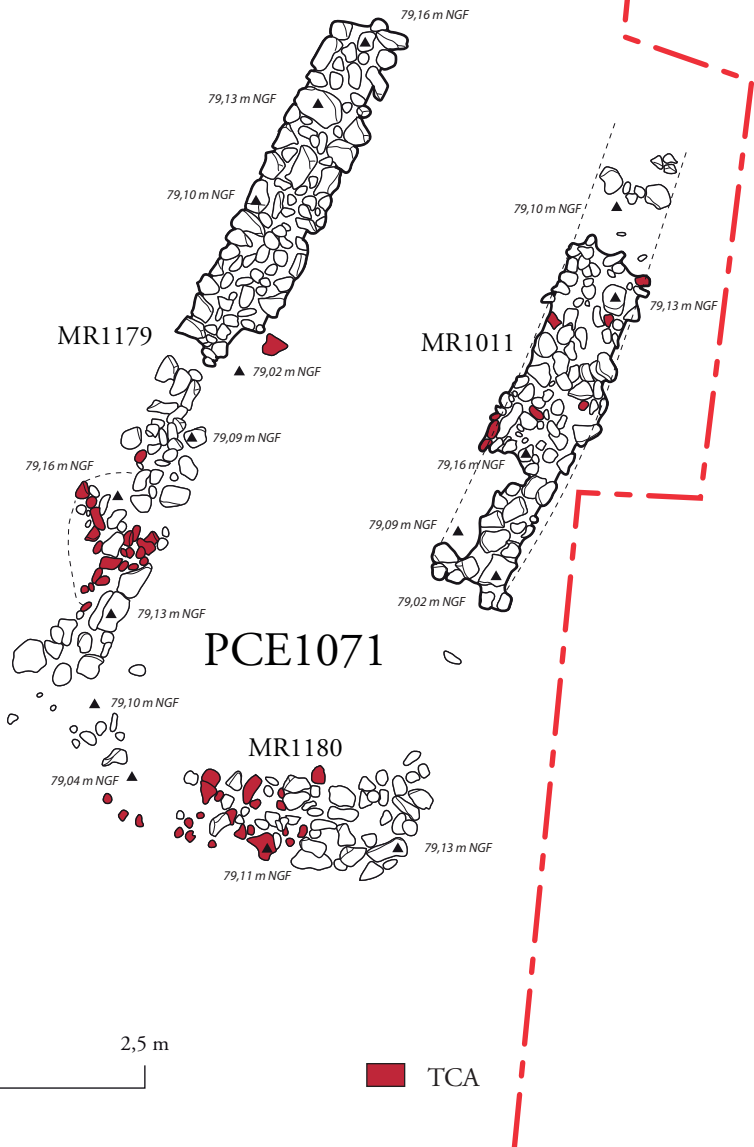


Céramique





Ech. 1/50 0 2,5 m





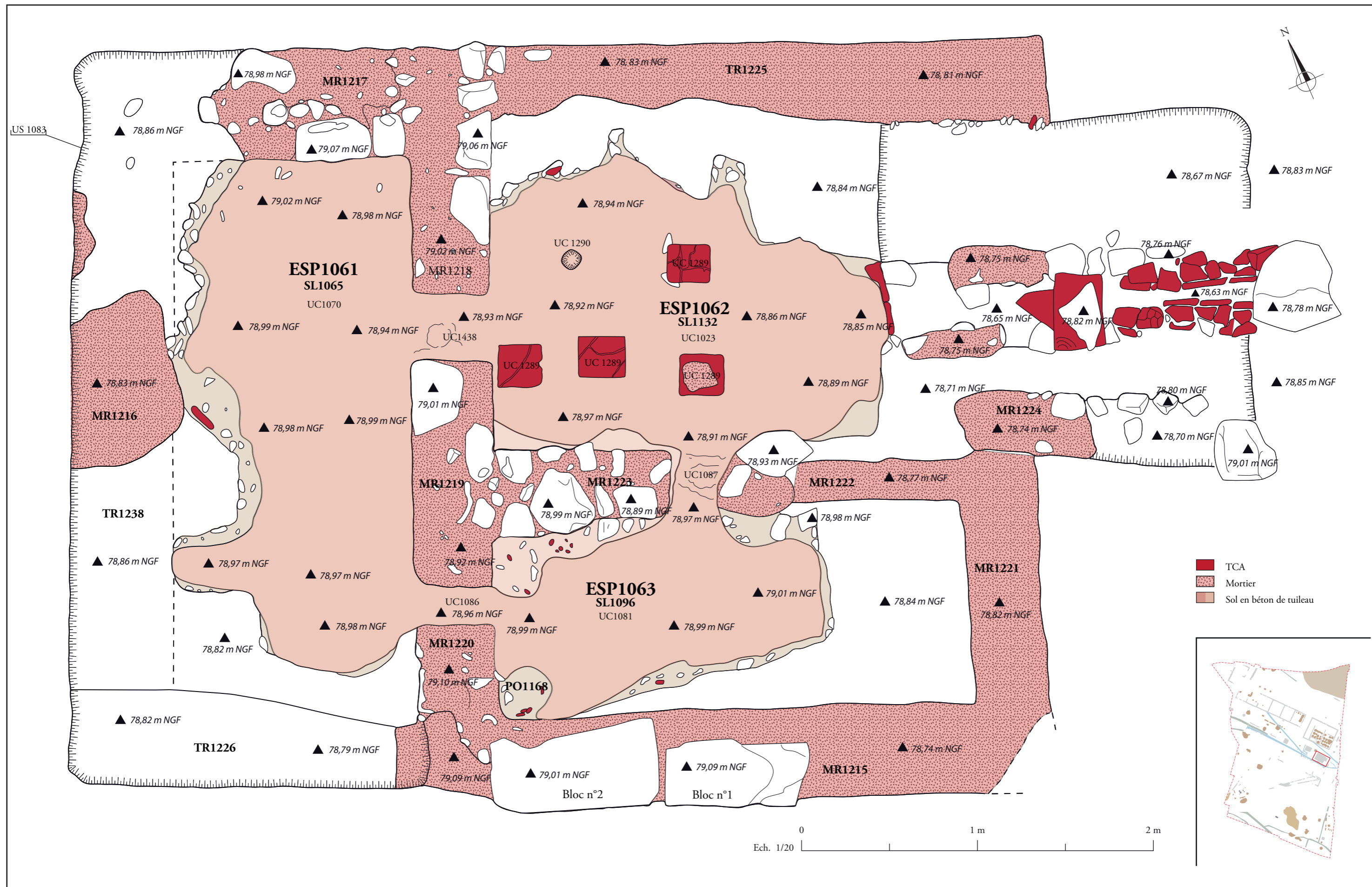


Fig. 58 : Plan de l'hypocauste (éch. : 1/20). (DAO : D. Baldassari, J. Grasso).

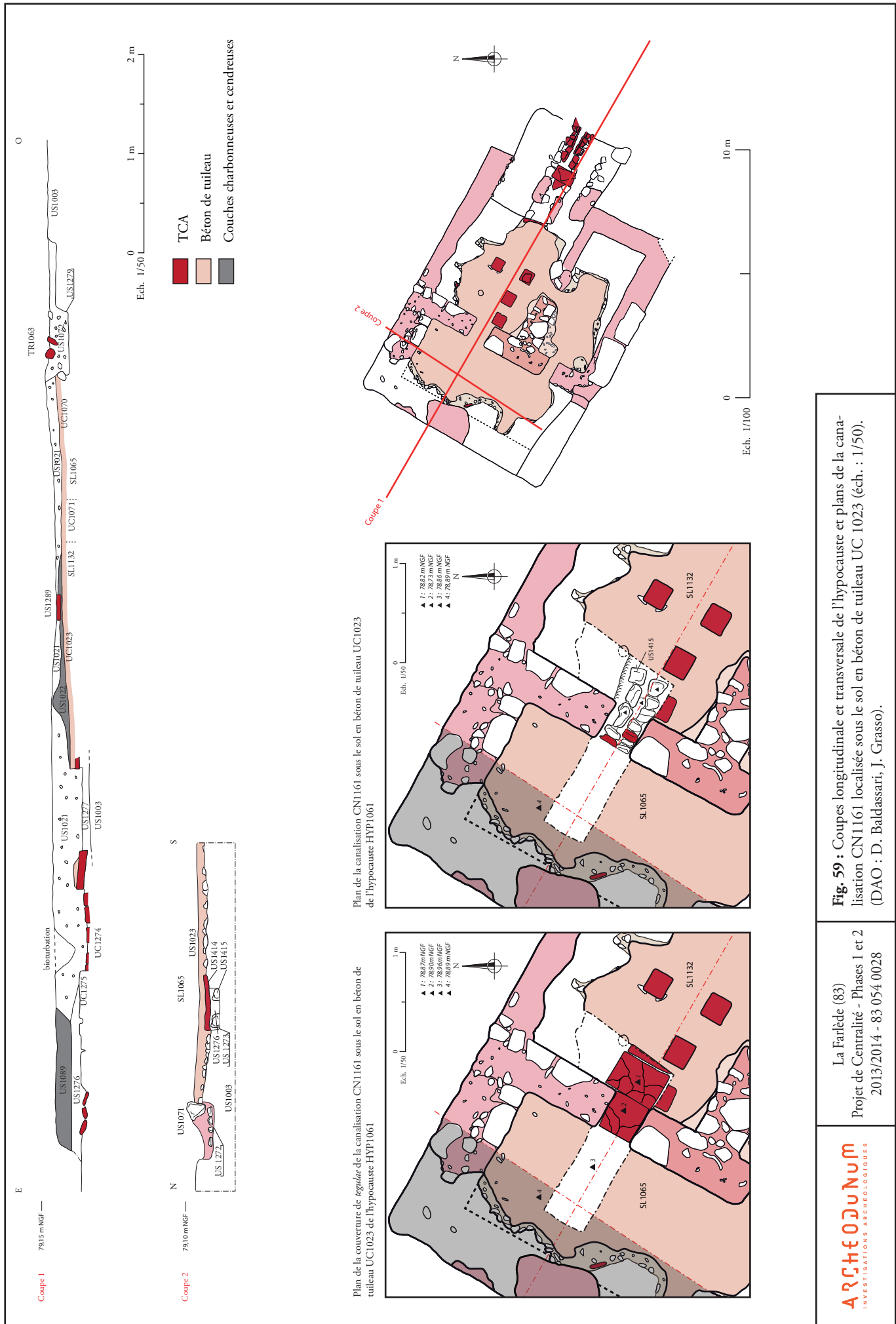


Fig. 59 : Coupes longitudinale et transversale de l'hypocauste et plans de la canalisation CNI1161 localisée sous le sol en béton de tuileau UC 1023 (éch. : 1/50). (DAO : D. Baldassari, J. Grasso).

La Farliède (83)
 Projet de Centralité - Phases 1 et 2
 2013/2014 - 83 054 0028









La Farlède (83)

Projet de Centralité - Phases 1 et 2
2013/2014 - 83 054 0028

ARCHEODUNUM
INVESTIGATIONS ARCHÉOLOGIQUES

Fig. 63 : Vues partielles de la couverture de la canalisation CN1161 sous la chape de mortier de tuileau US 1023 de l'hypocauste, avant et après démontage. (Clichés : Archeodunum).



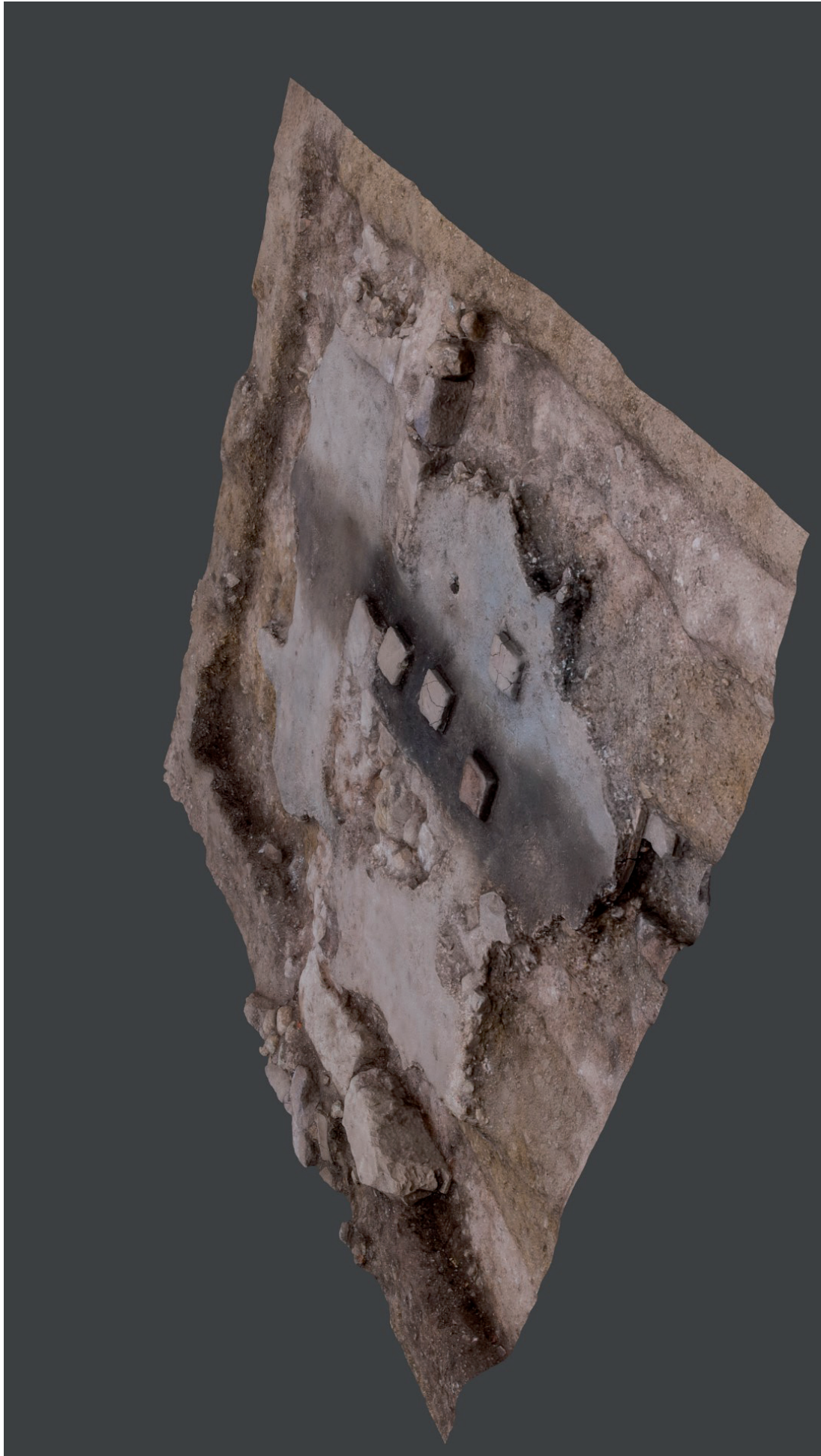
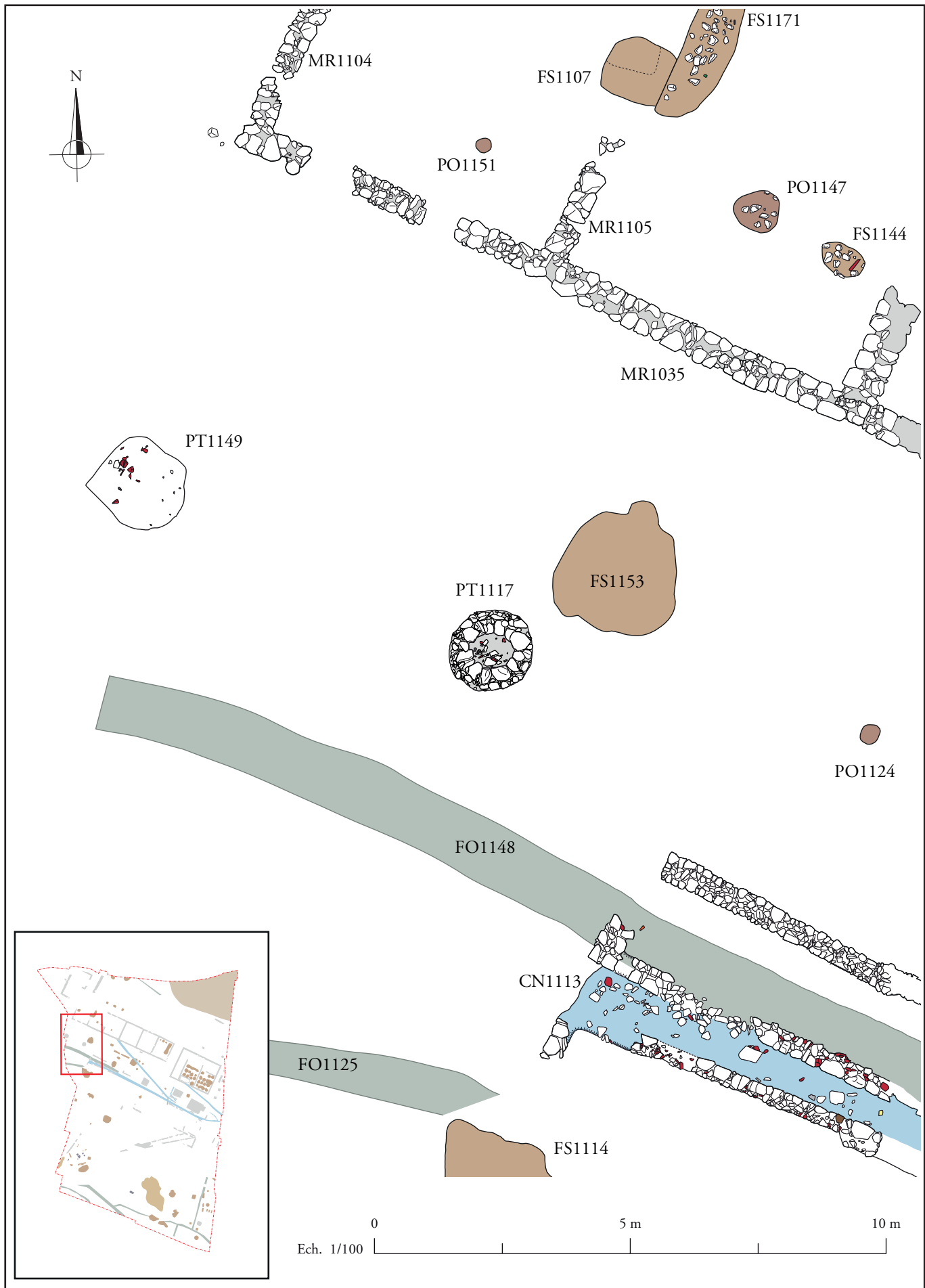


Fig. 65 : Modélisation 3D de l'hypocauste réalisée à partir des relevés photogrammétriques. (Clichés : D. Baldassari ; infographie : Q. Rochet).

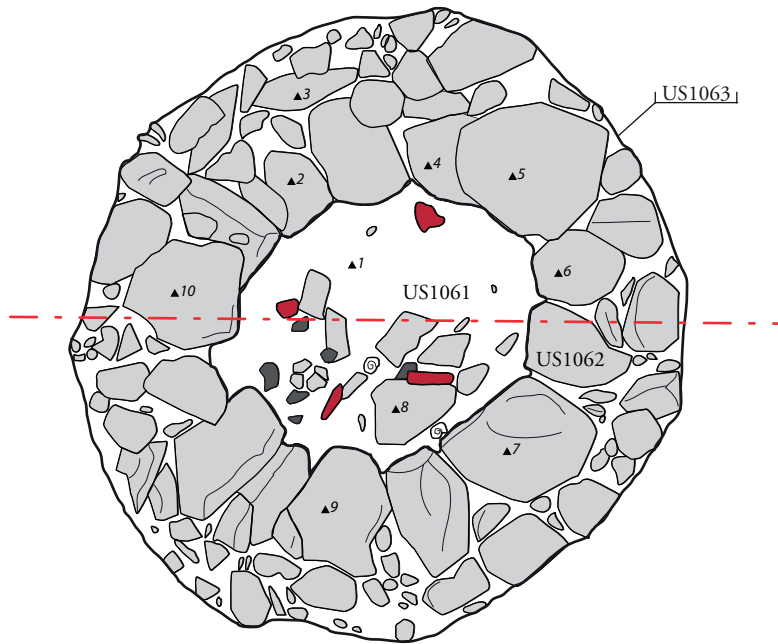
La Farlède (83)
Projet de Centralité - Phases 1 et 2
2013/2014 - 83 054 0028







- ▲ 1 80,21 m NGF
- ▲ 2 79,98 m NGF
- ▲ 3 80,05 m NGF
- ▲ 4 80,08 m NGF
- ▲ 5 80,18 m NGF
- ▲ 6 80,28 m NGF
- ▲ 7 80,26 m NGF
- ▲ 8 80,23 m NGF
- ▲ 9 80,26 m NGF
- ▲ 10 80,29 m NGF



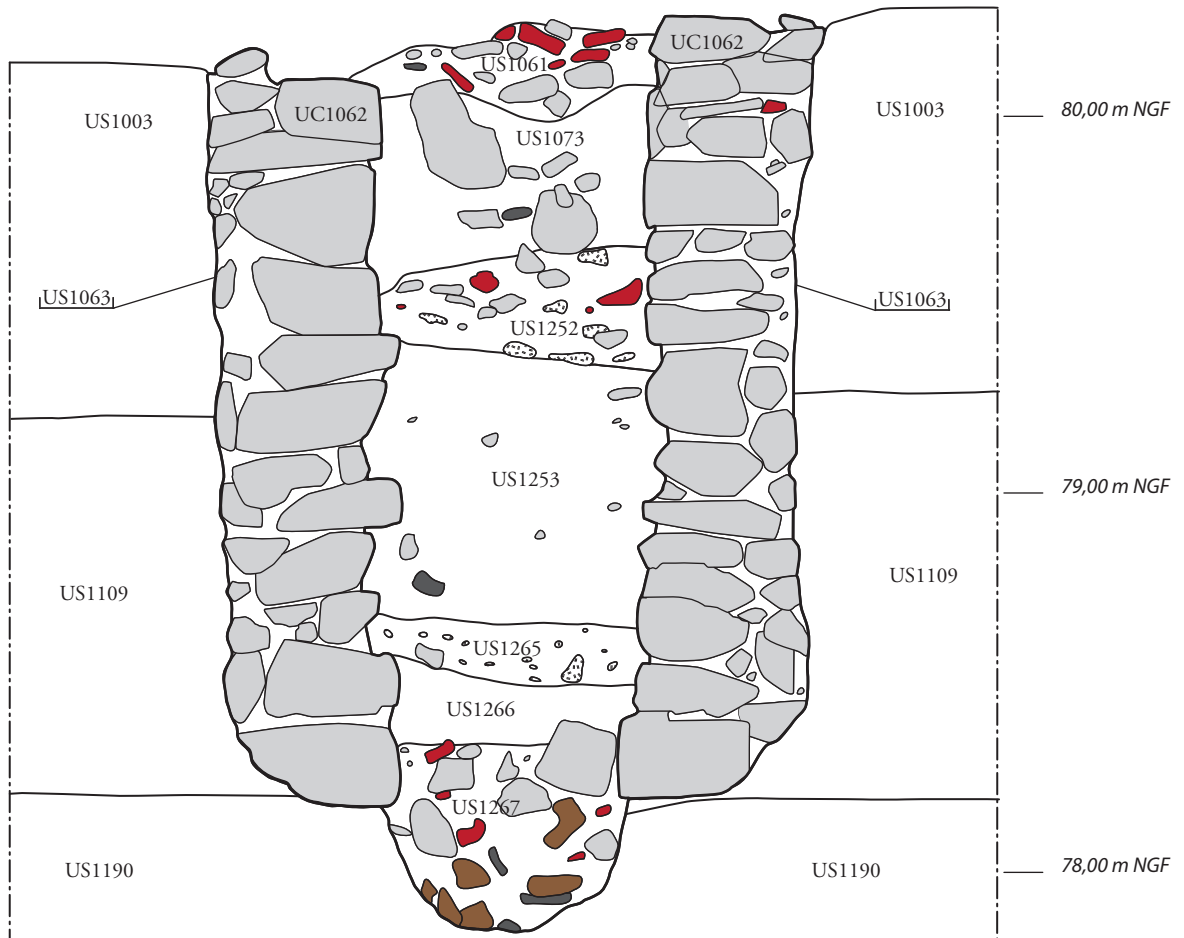
- Pierre
- TCA
- céramique
- dolium
- mortier

PT1117

Ech. 1/20 0 1 m

E

O







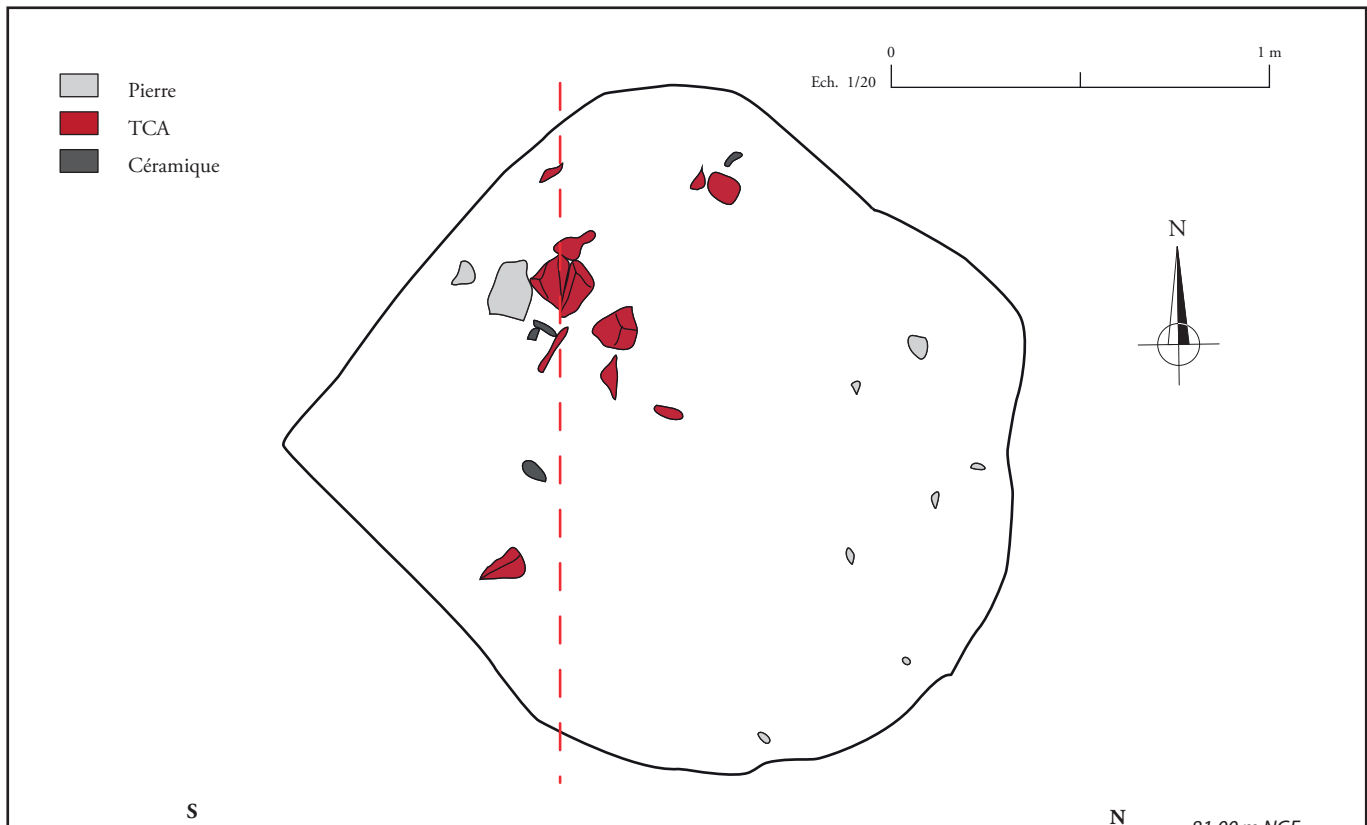
La Farlède (83)

Projet de Centralité - Phases 1 et 2
2013/2014 - 83 054 0028

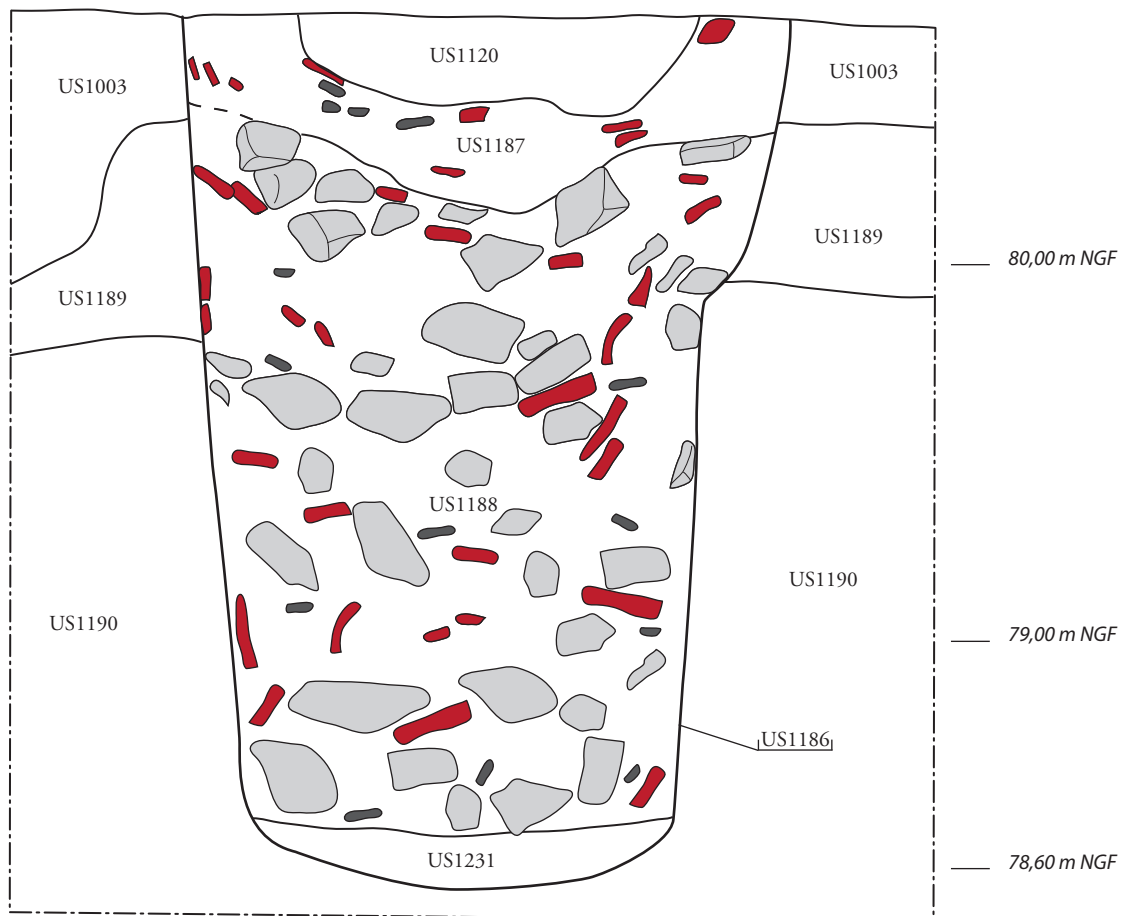
ARCHEODUNUM
INVESTIGATIONS ARCHÉOLOGIQUES

Fig. 70 : Vue de la coupe est-ouest du puits PT1117. Vue de détail du surcreusement dans le fond du puits PT1117. (Clichés : Archeodunum).





PT1149







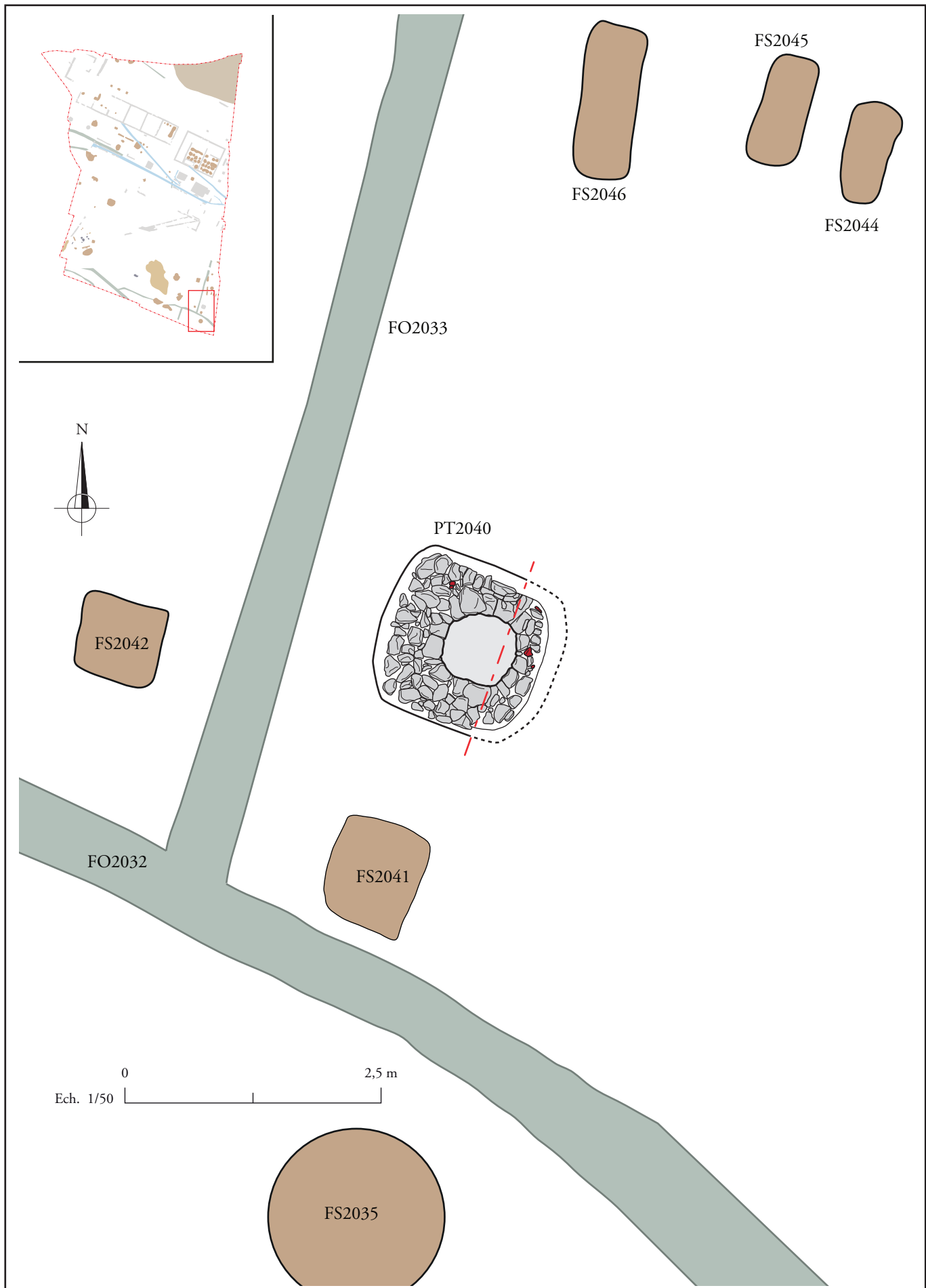
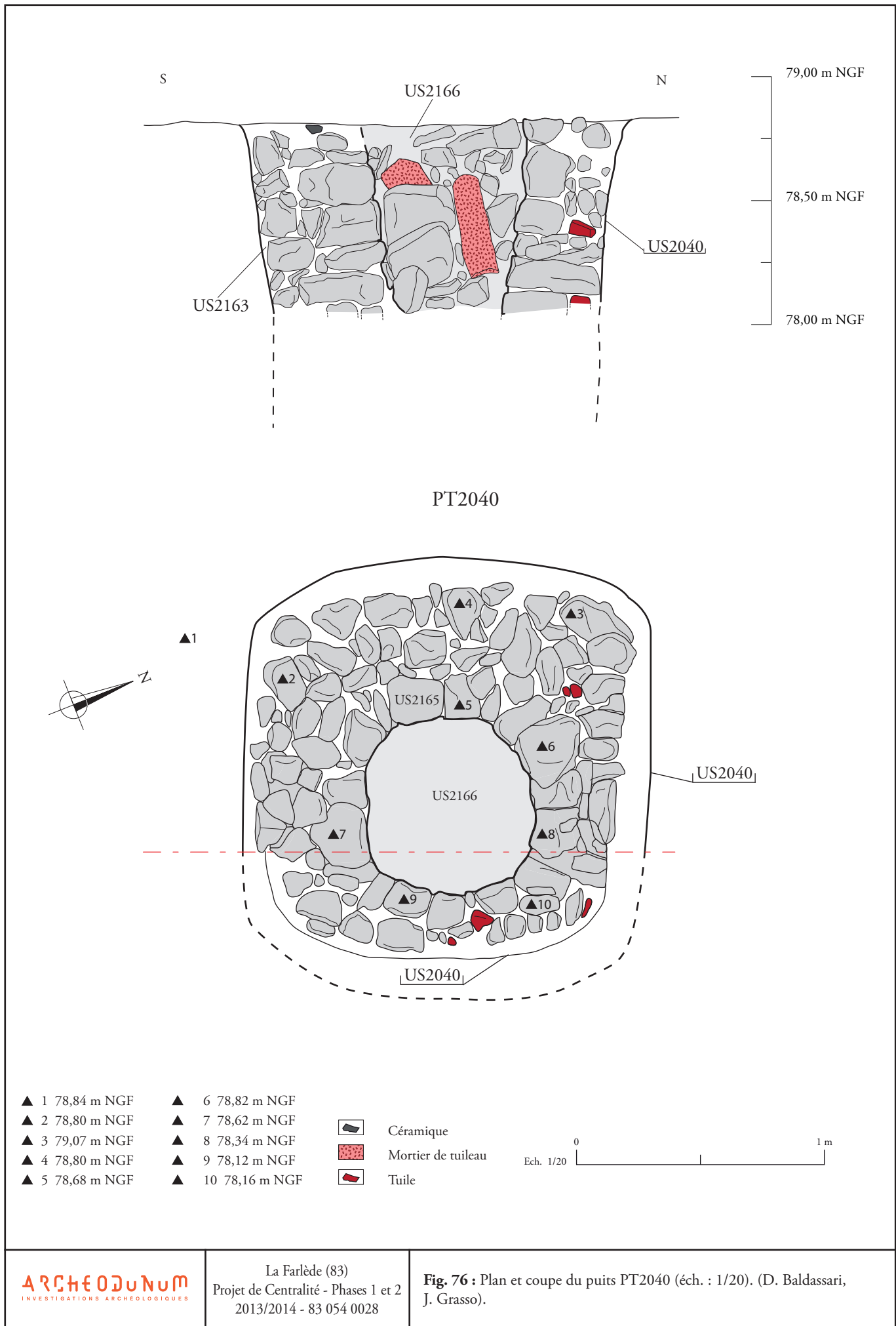


Fig. 75 : Plan de localisation du puits PT2040 (éch. : 1/100). (D. Baldassari, J. Grasso).





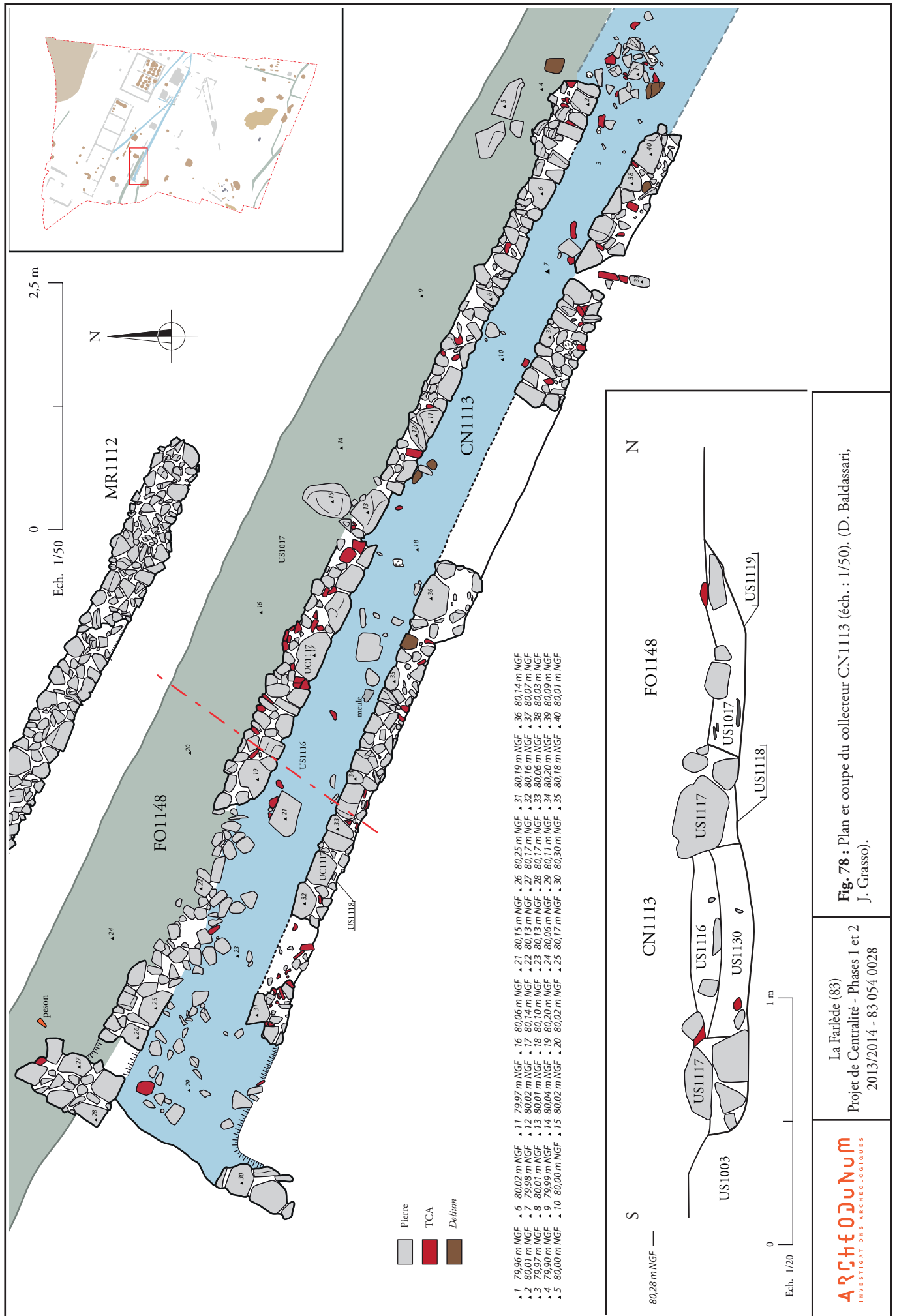
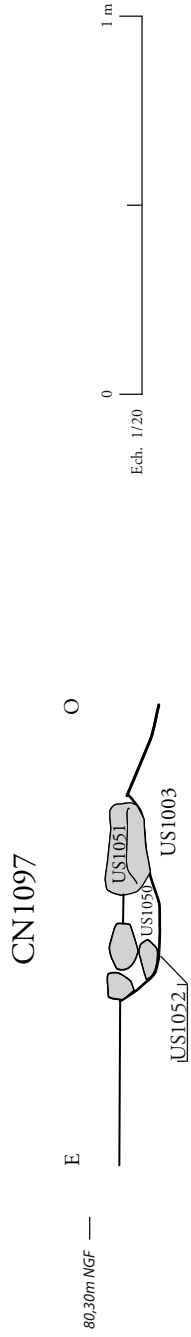


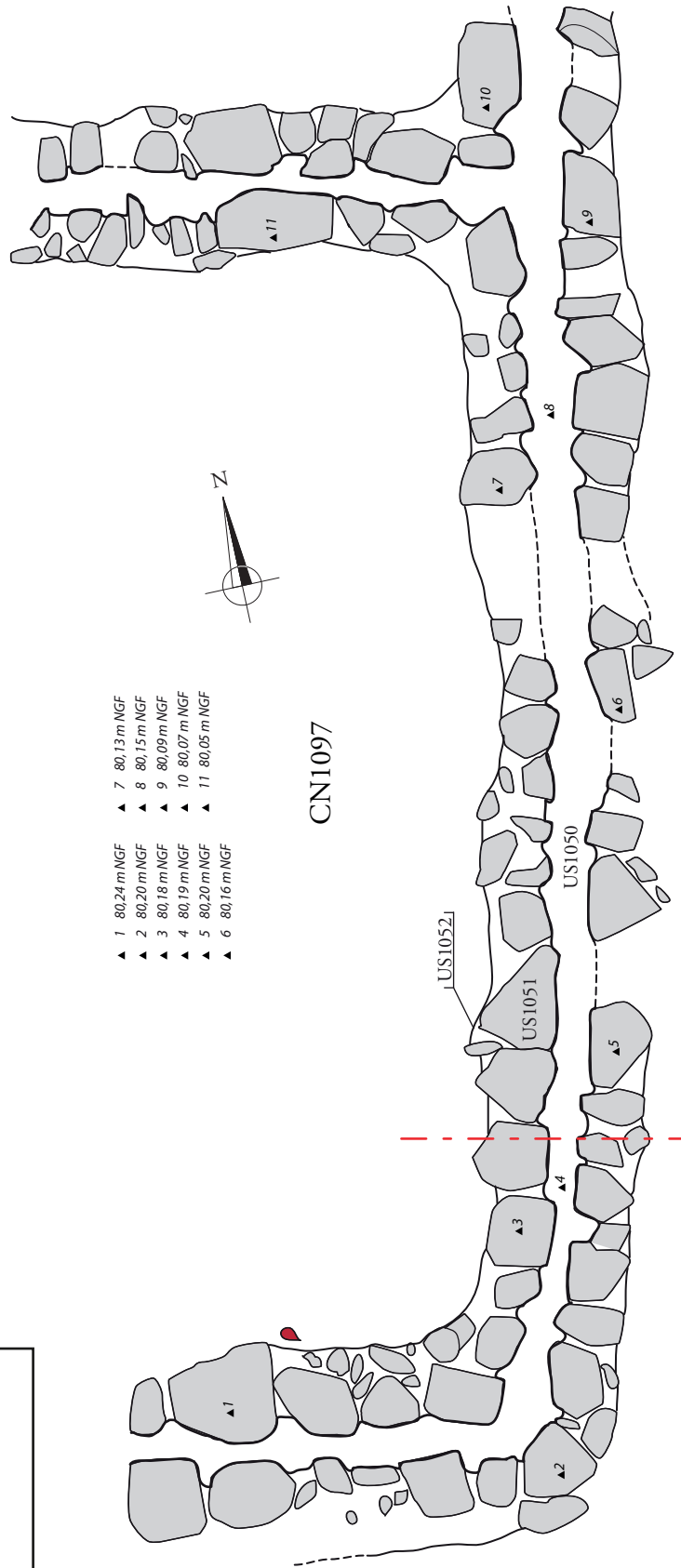
Fig. 78 : Plan et coupe du collecteur CN1113 (éch. : 1/50). (D. Baldassari, J. Grasso).

La Farliède (83)
 Projet de Centralité - Phases 1 et 2
 2013/2014 - 83 054 0028





- ▲ 1 80,24 m NGF
- ▲ 2 80,20 m NGF
- ▲ 3 80,18 m NGF
- ▲ 4 80,19 m NGF
- ▲ 5 80,20 m NGF
- ▲ 6 80,16 m NGF
- ▲ 7 80,13 m NGF
- ▲ 8 80,15 m NGF
- ▲ 9 80,09 m NGF
- ▲ 10 80,07 m NGF
- ▲ 11 80,05 m NGF



ARCHEODUNUM
INVESTIGATIONS ARCHÉOLOGIQUES

La Farliède (83)
Projet de Centralité - Phases 1 et 2
2013/2014 - 83 054 0028

Fig. 80 : Plan et coupe de la canalisation CN1097 (éch. : 1/20). (D. Baldassari, J. Grasso).





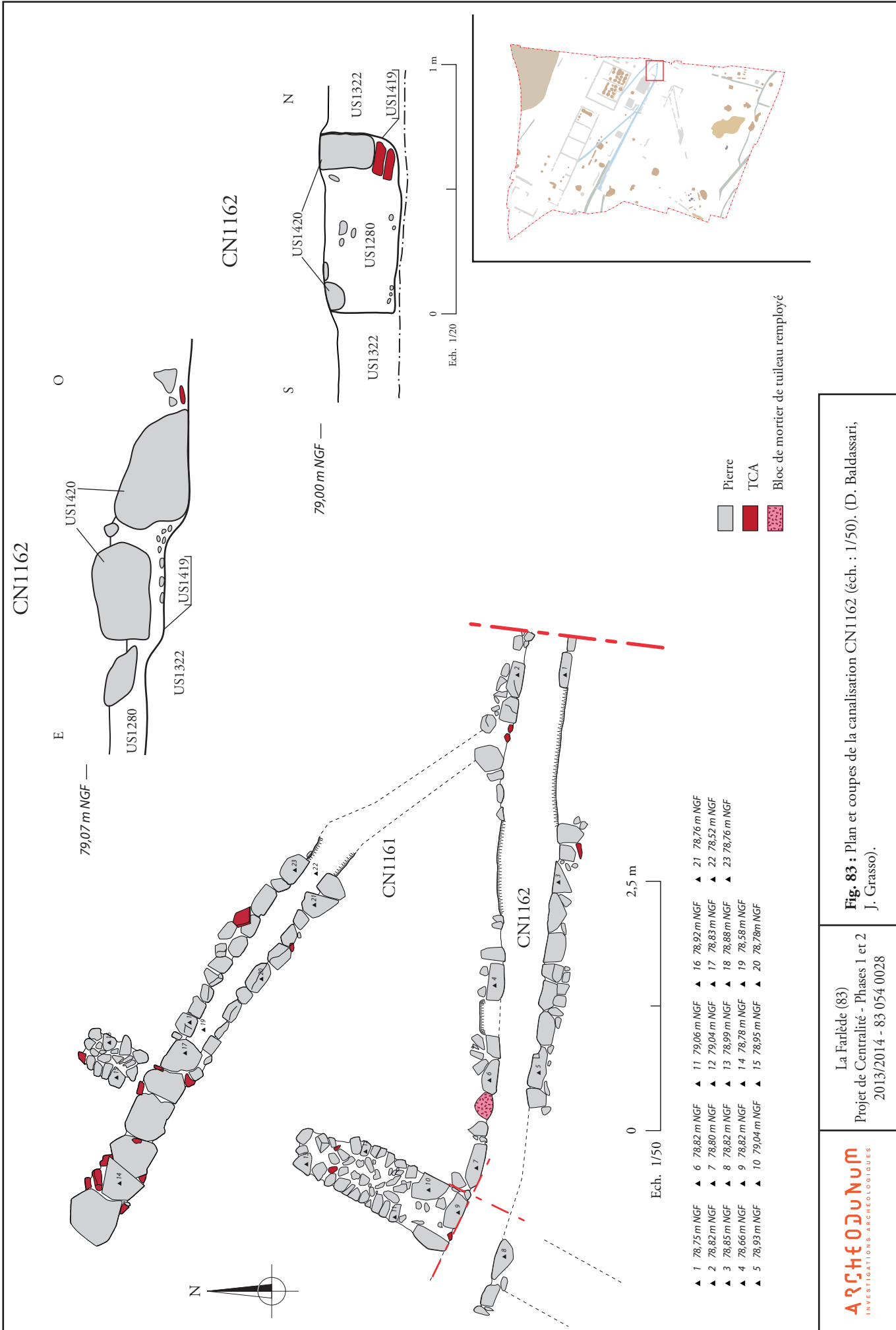


Fig. 83 : Plan et coupes de la canalisation CN1162 (éch. : 1/50). (D. Baldassari, J. Grasso).

La Farliède (83)
 Projet de Centralité - Phases 1 et 2
 2013/2014 - 83 054 0028

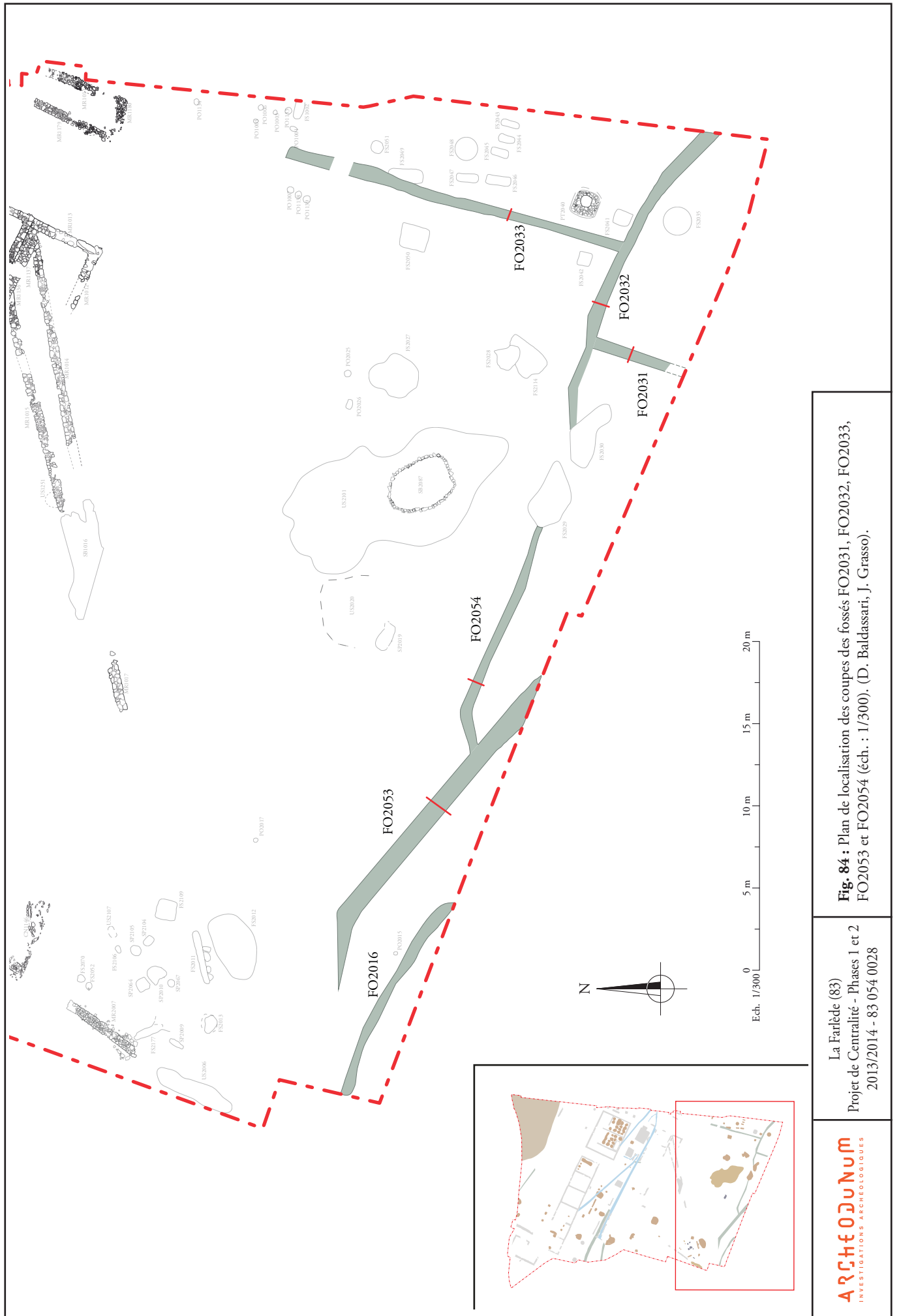
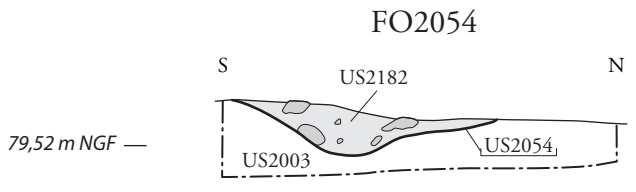
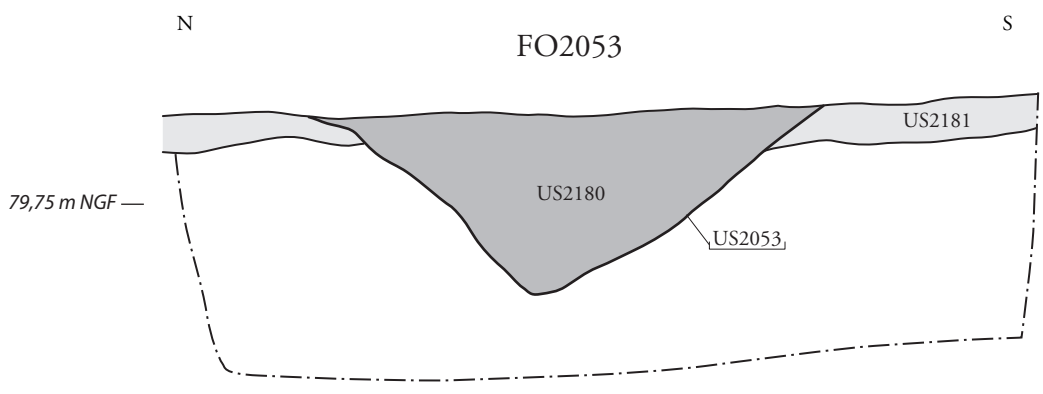
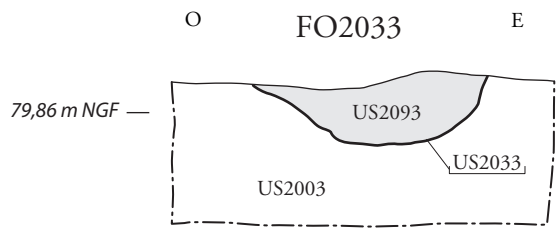
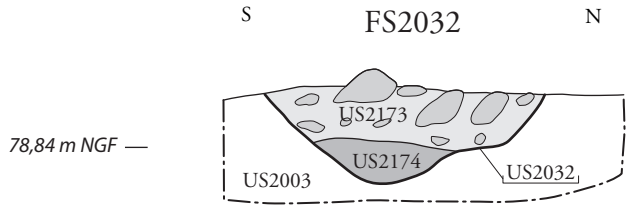
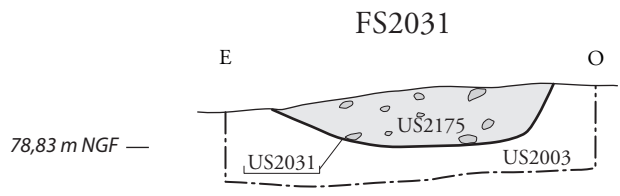
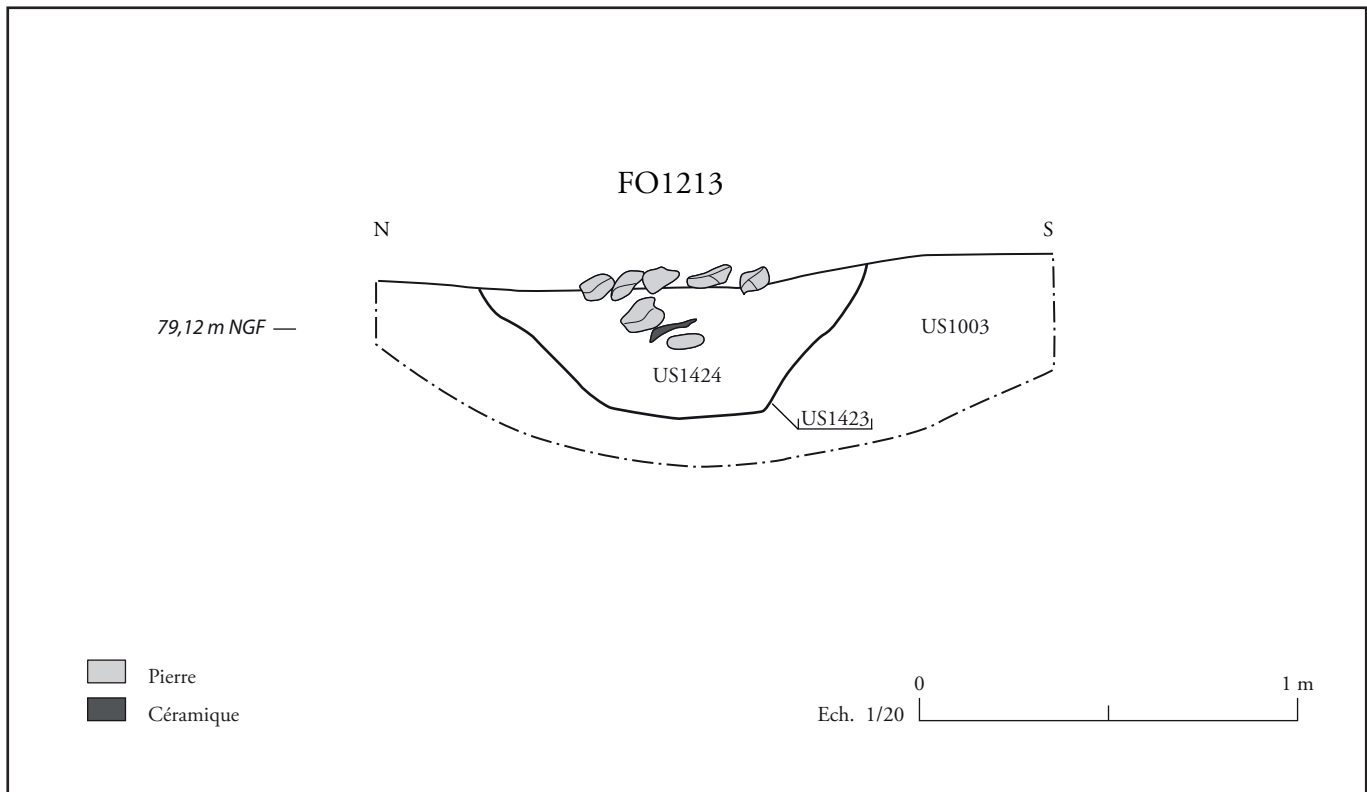



Fig. 84 : Plan de localisation des coupes des fossés FO2031, FO2032, FO2033, FO2053 et FO2054 (éch. : 1/300). (D. Baldassari, J. Grasso).

La Farliède (83)
 Projet de Centralité - Phases 1 et 2
 2013/2014 - 83 054 0028





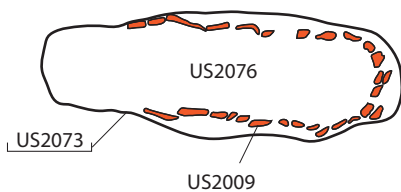




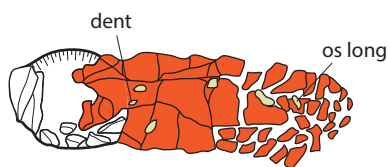
 La Farlède (83)
 Projet de Centralité - Phases 1 et 2
 2013/2014 - 83 054 0028

Fig. 86 : Coupe du fossé FO1213 (éch. : 1/20). (D. Baldassari, J. Grasso).

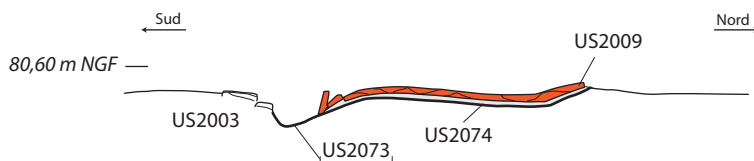
Niveau d'apparition



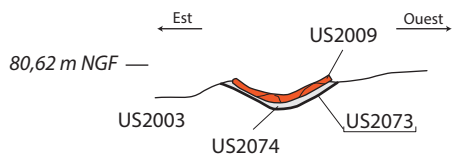
Niveau d'inhumation



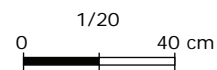
Coupe longitudinale

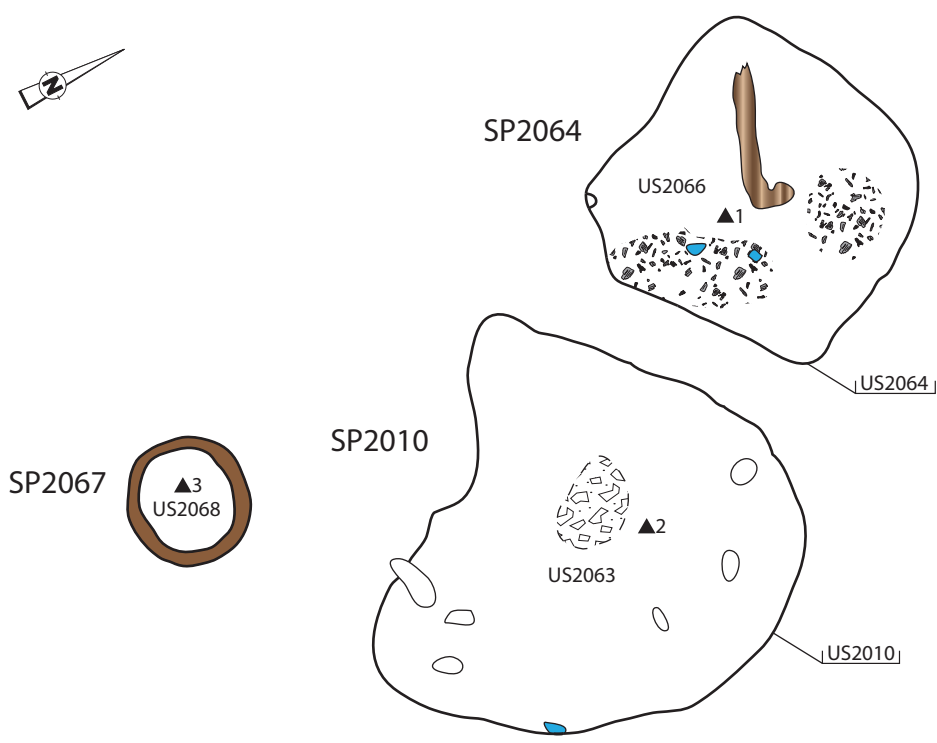







Coupe transversale



- Amphore
- Os (US 2075)





-  racine
-  verre
-  zone charbonneuse
-  concentration d'esquilles osseuses
-  dolium

- ▲ 1 : 80,48 m NGF
- ▲ 2 : 80,39 m NGF
- ▲ 3 : 80,37 m NGF

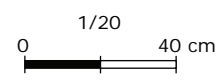
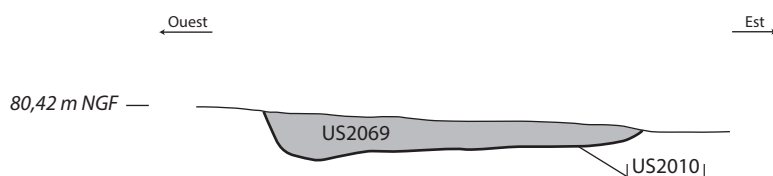
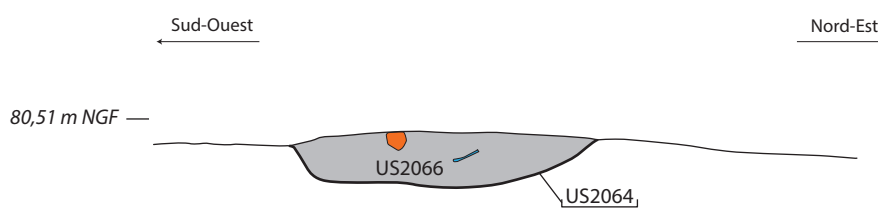


Figure 88 : relevés en plan des tombes SP2010, SP2064 et SP2067 (éch. : 1/20) ; cliché du niveau d'apparition des 3 tombes. (DAO : J. Grasso, D. Baldassari ; cliché : D. Baldassari).

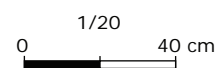
Coupe de la tombe SP2010



Coupe de la tombe SP2064



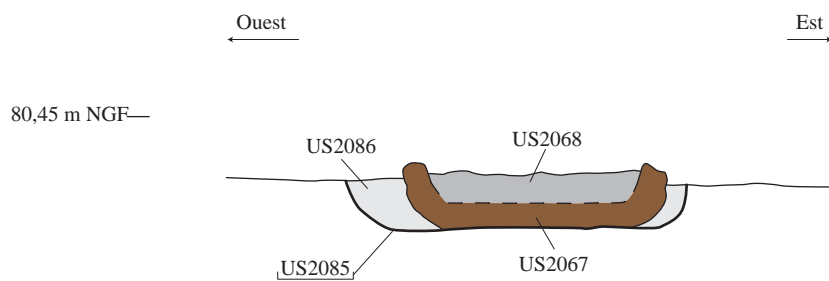
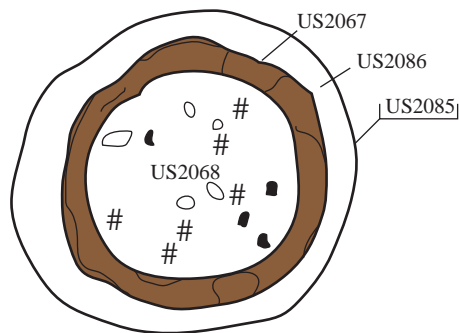
- verre
- TCA/Argile



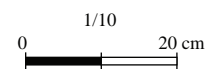
Vue en coupe de la tombe SP2010



Vue en plan de la tombe SP2064



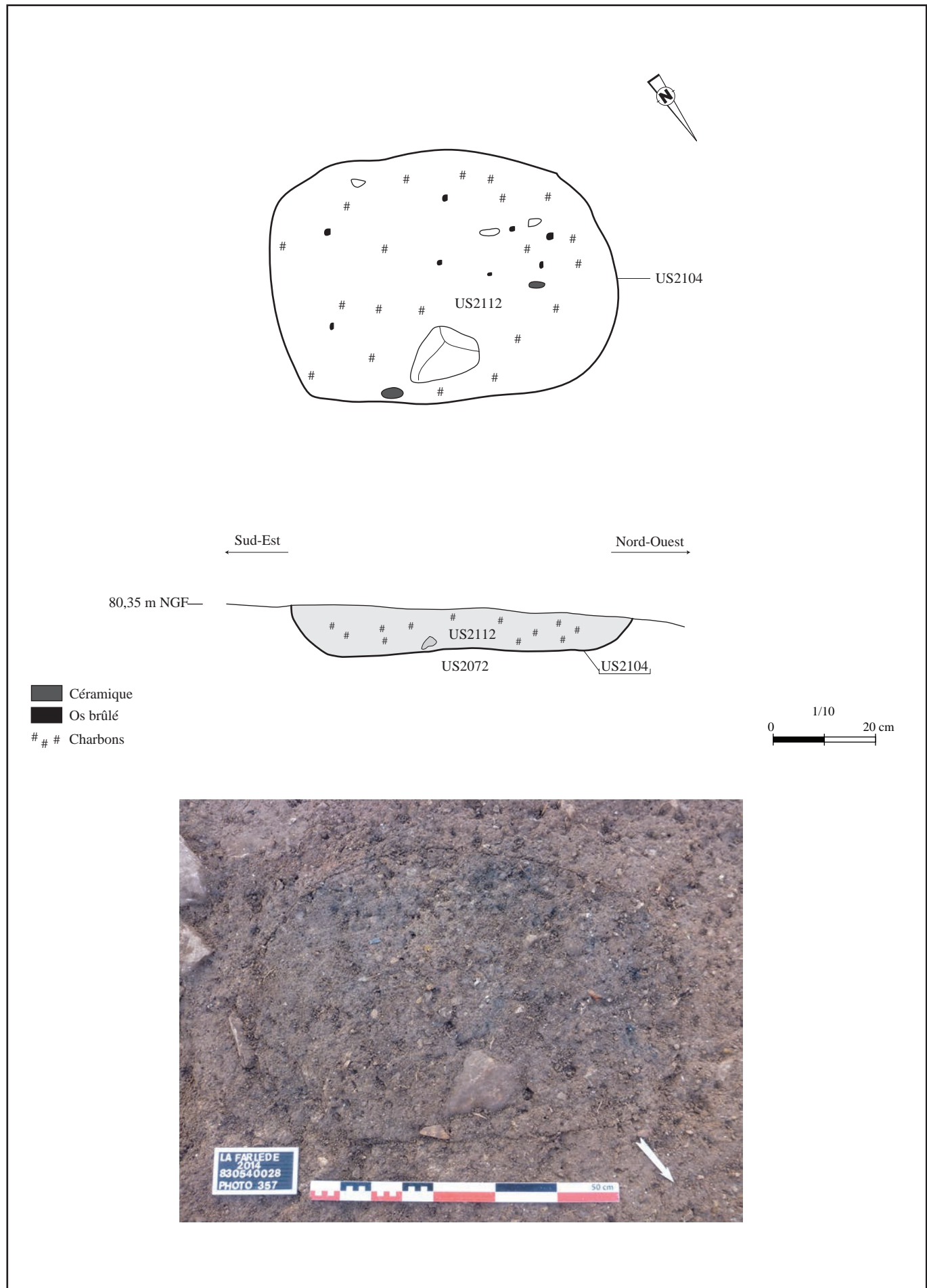
- Dolium
- Os brûlés
- ### Charbons

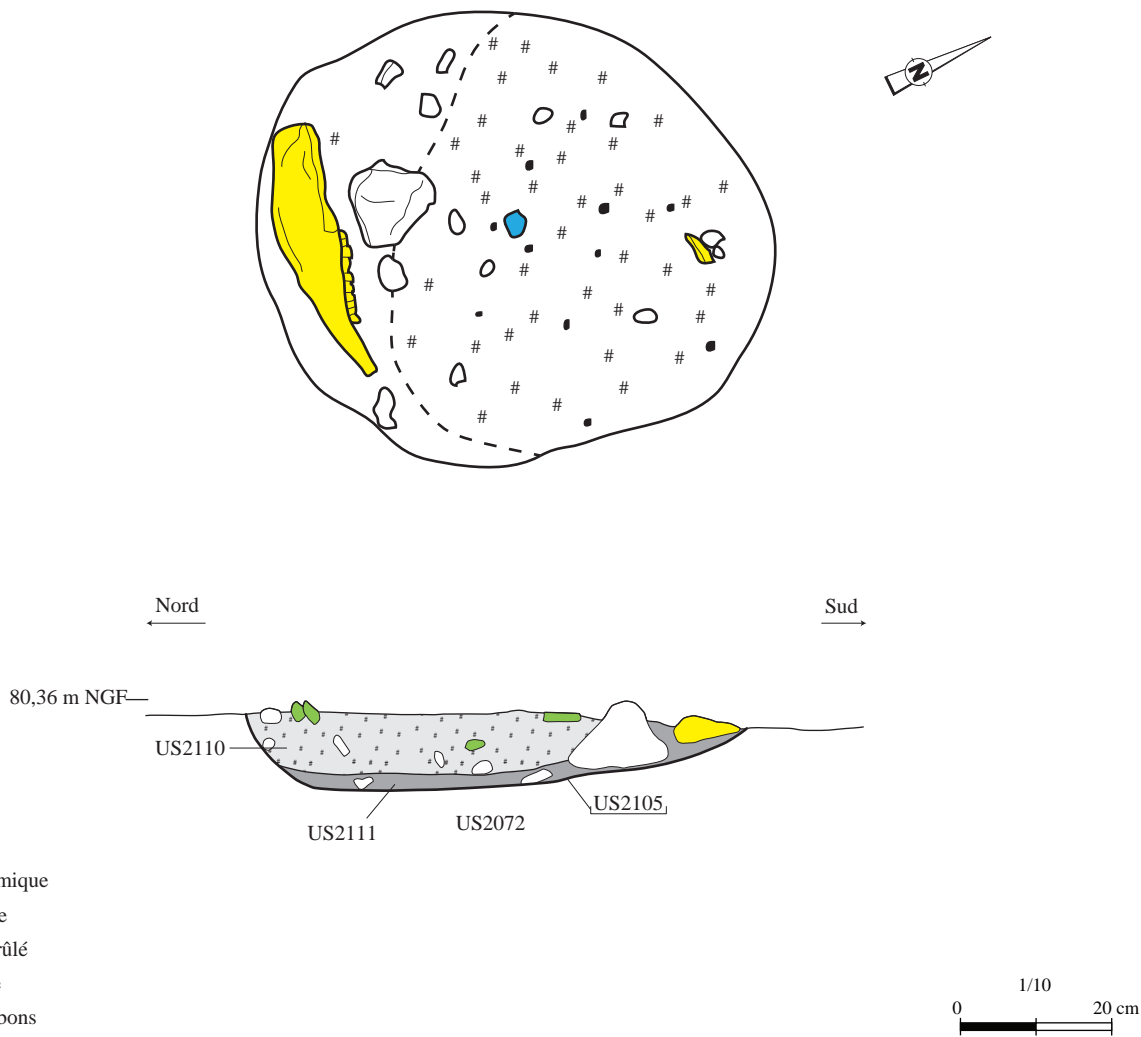


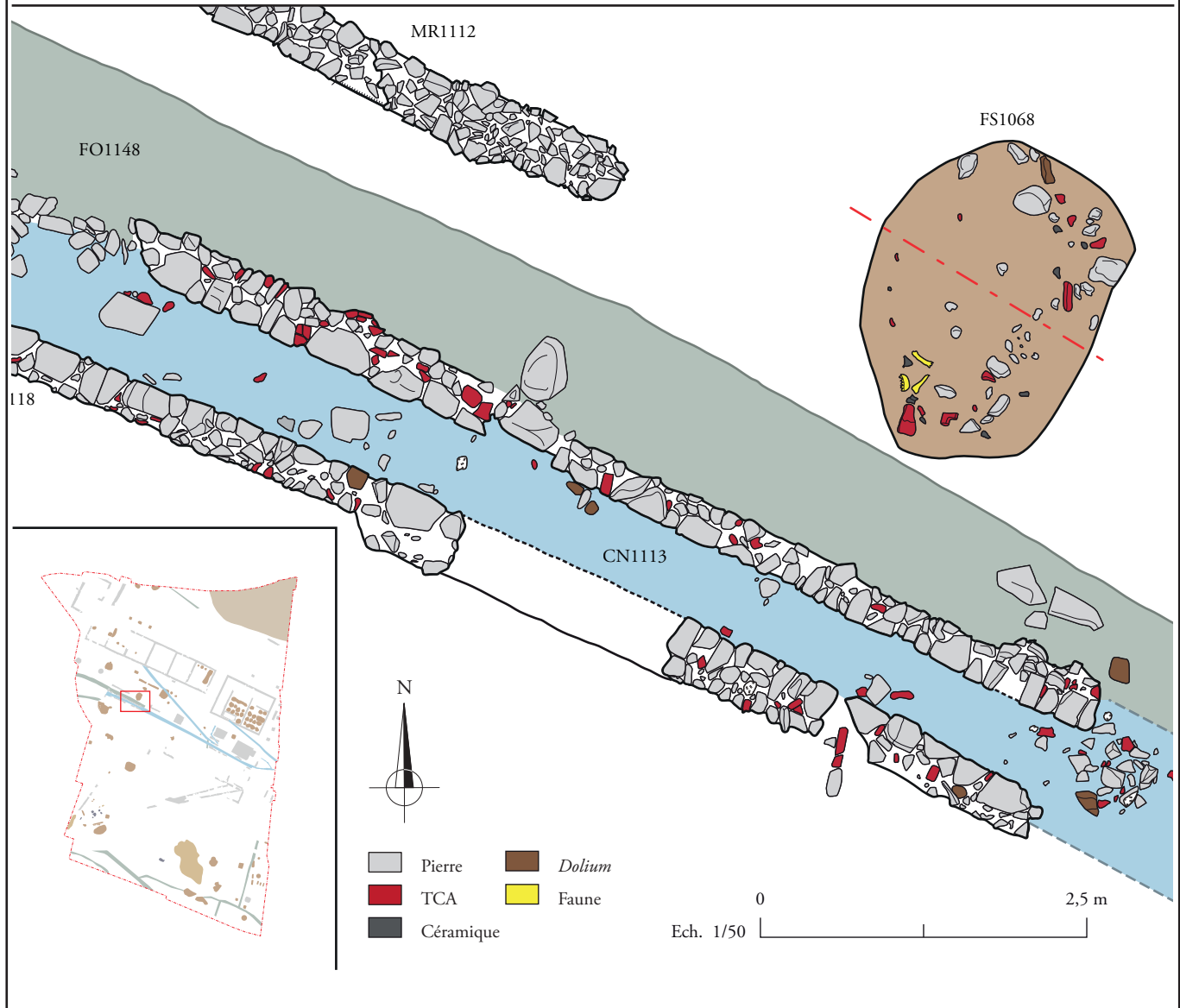
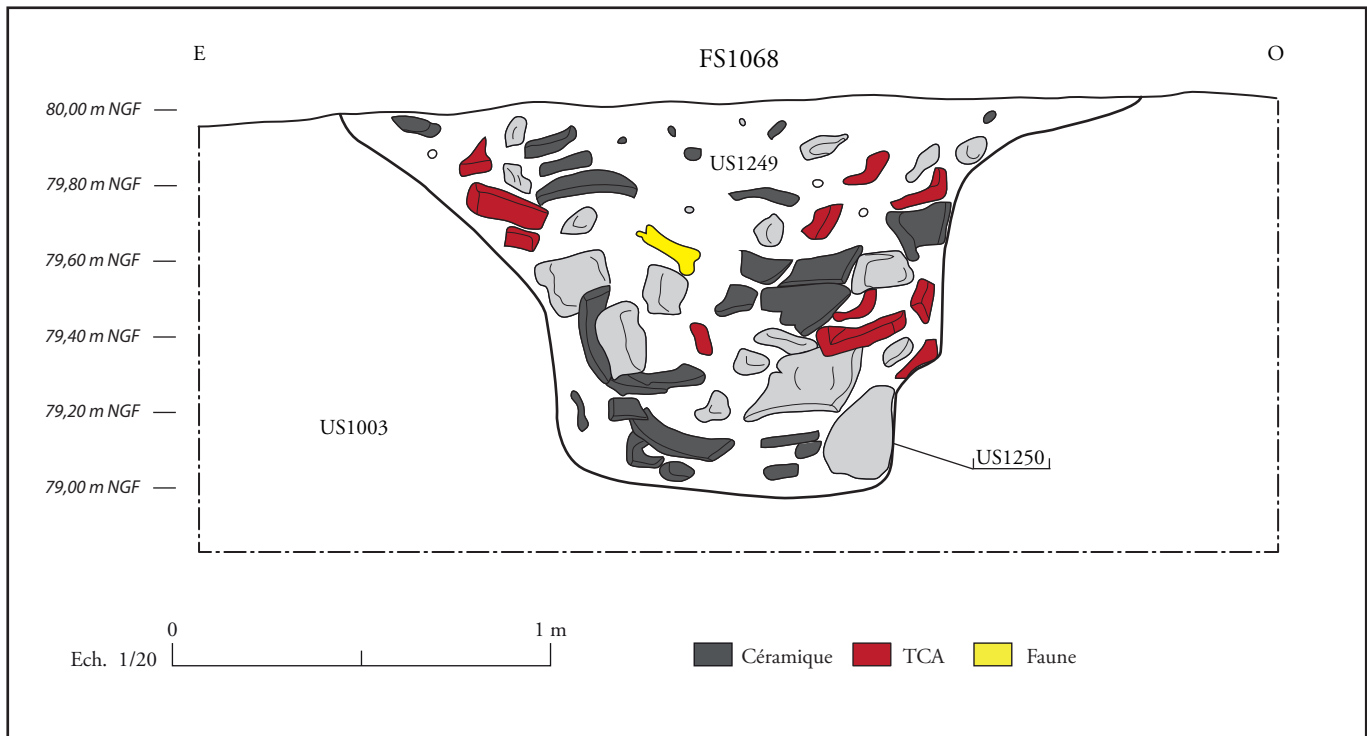
Vue en plan de la tombe SP2067



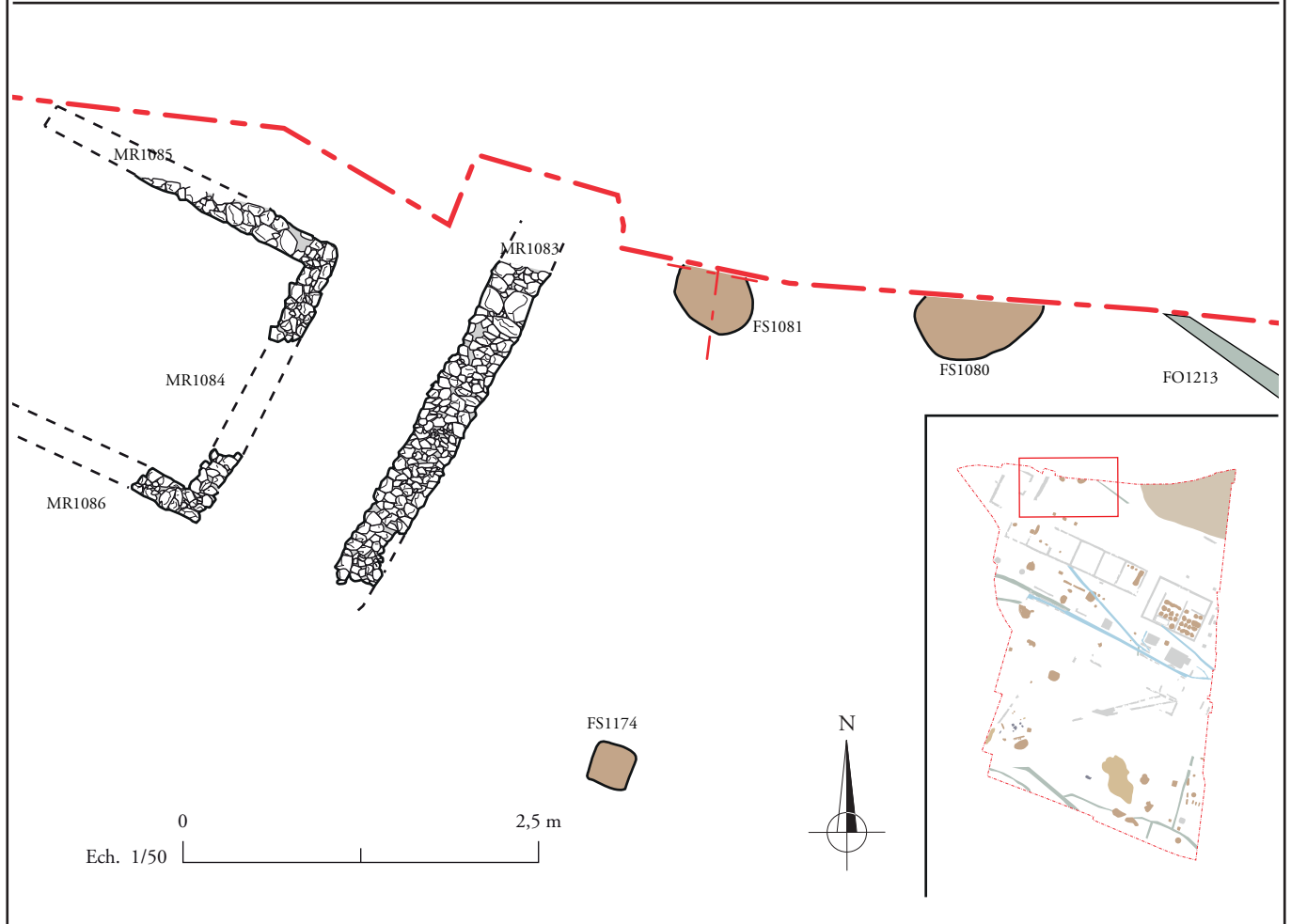
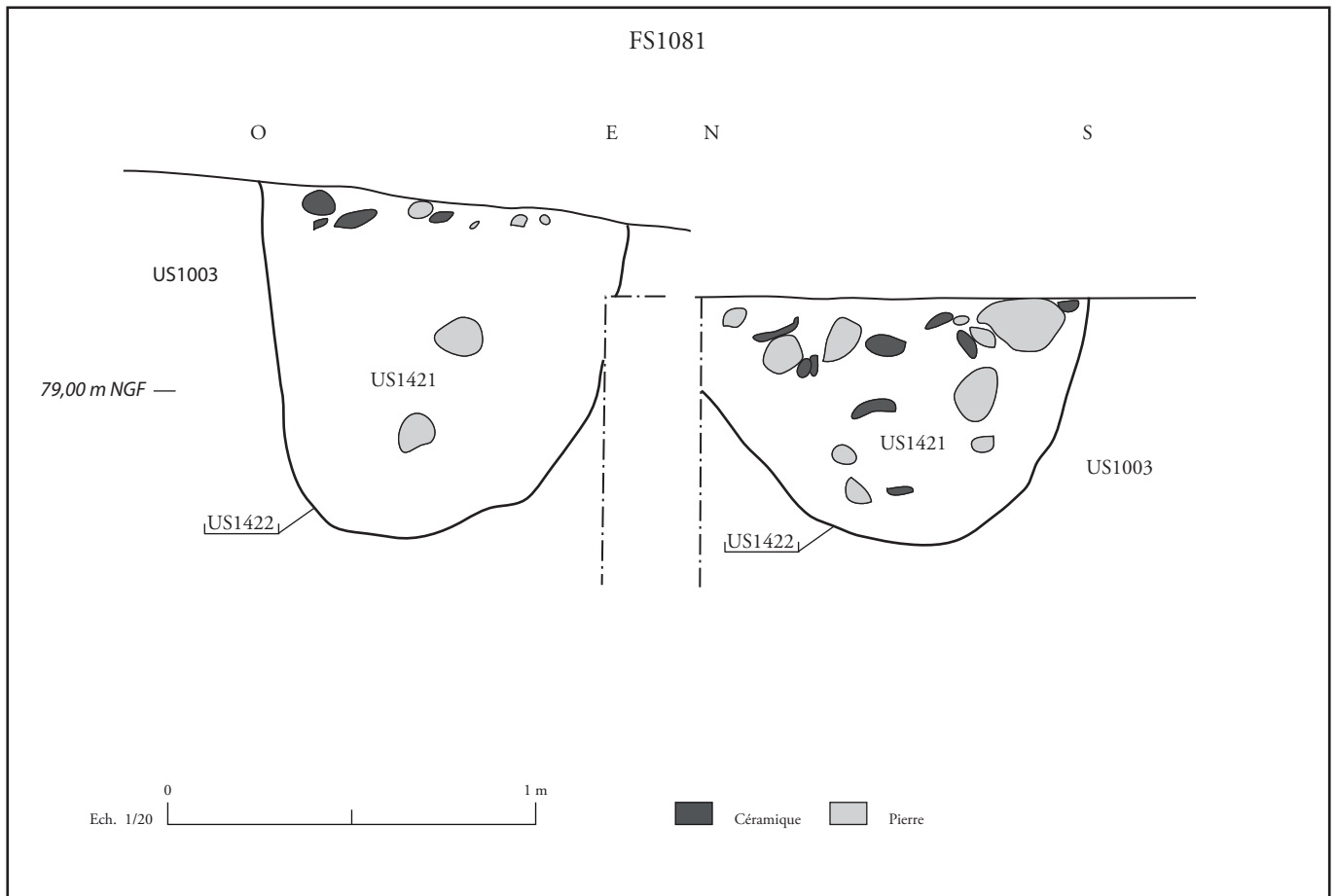
Vue en coupe de la tombe SP2067











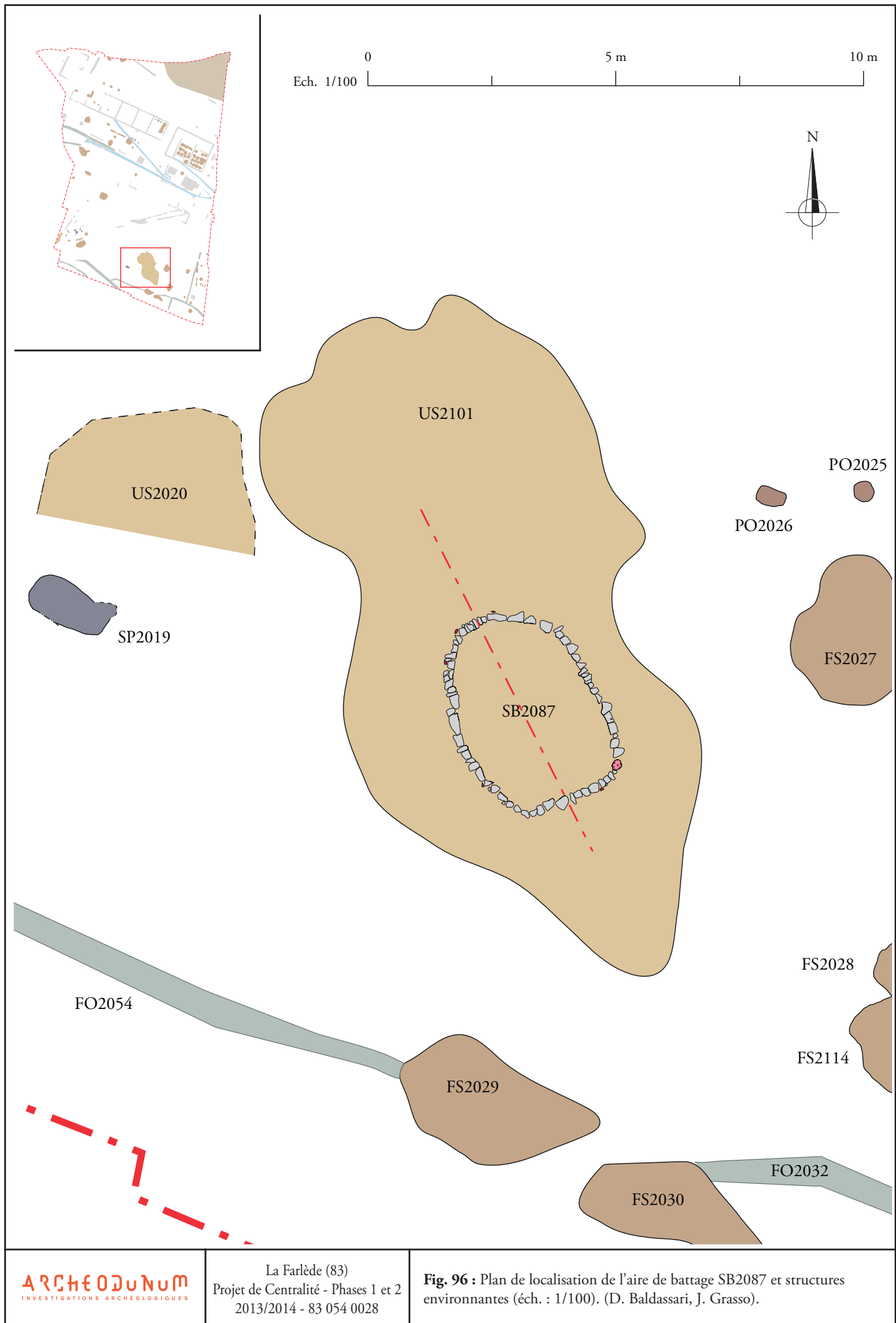
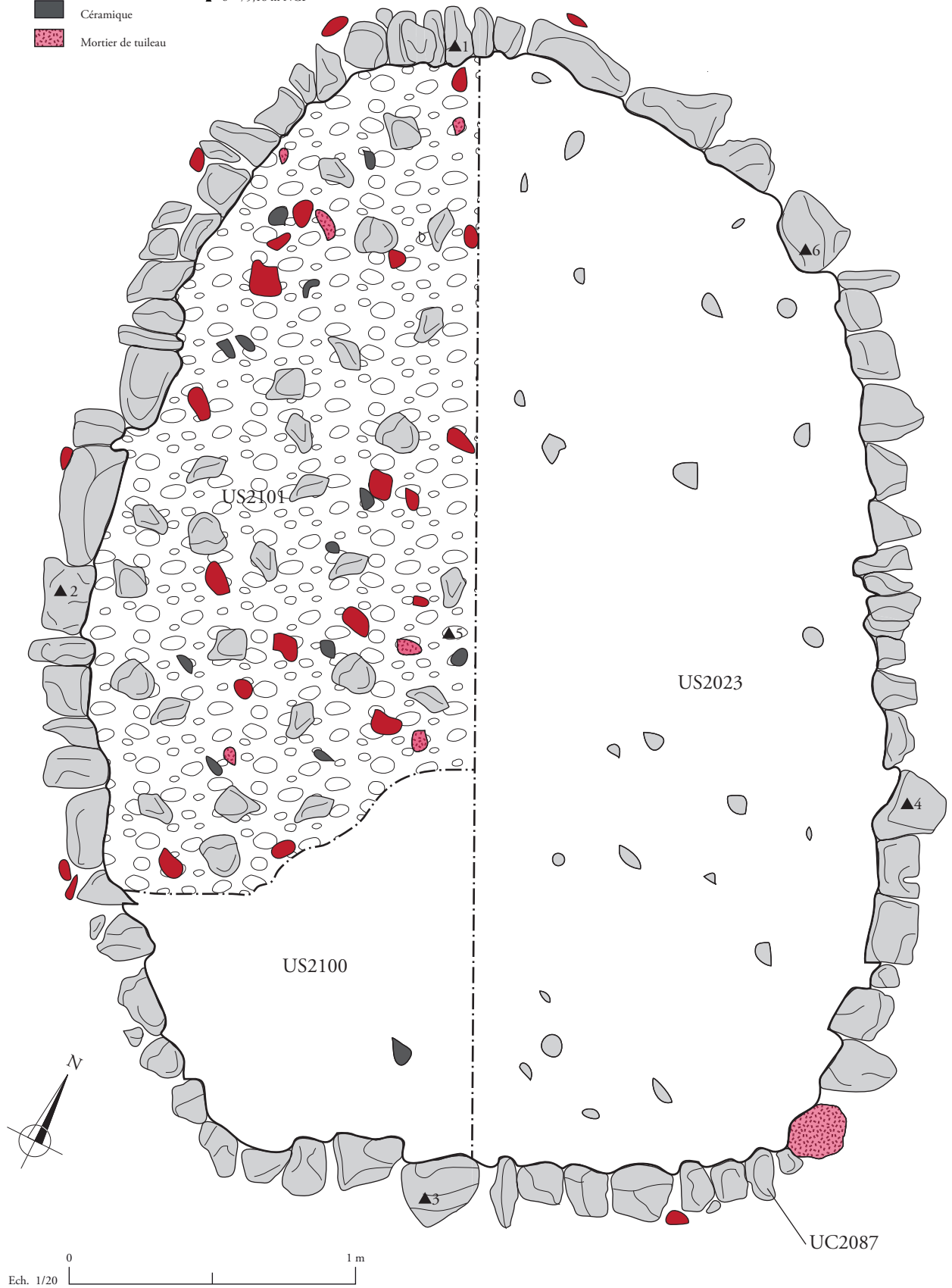


Fig. 96 : Plan de localisation de l'aire de battage SB2087 et structures environnantes (éch. : 1/100). (D. Baldassari, J. Grasso).

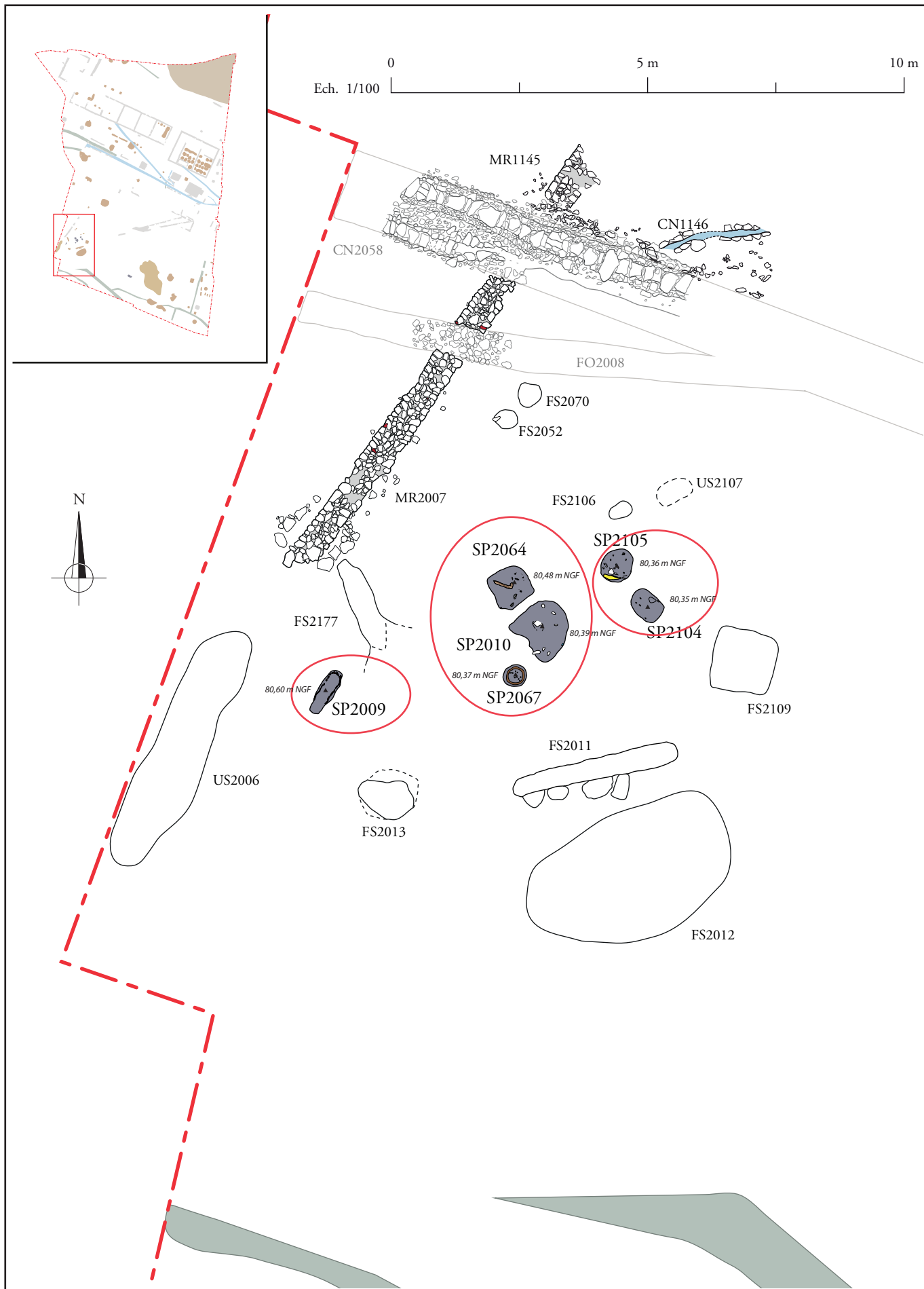
La Farlède (83)
 Projet de Centralité - Phases 1 et 2
 2013/2014 - 83 054 0028

- Pierre
- TCA
- Céramique
- Mortier de tuileau

- ▲ 1 79,20 m NGF
- ▲ 2 79,12 m NGF
- ▲ 3 79,23 m NGF
- ▲ 4 79,24 m NGF
- ▲ 5 78,92 m NGF
- ▲ 6 79,18 m NGF

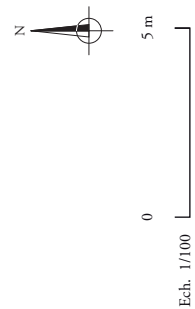
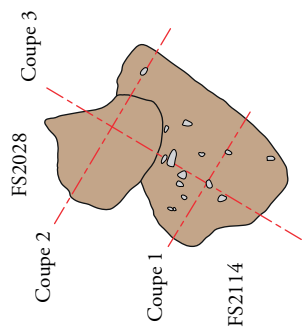




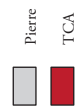
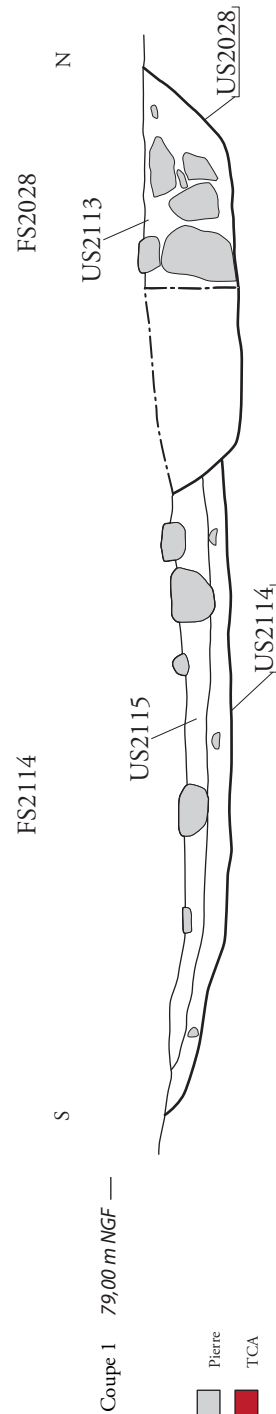
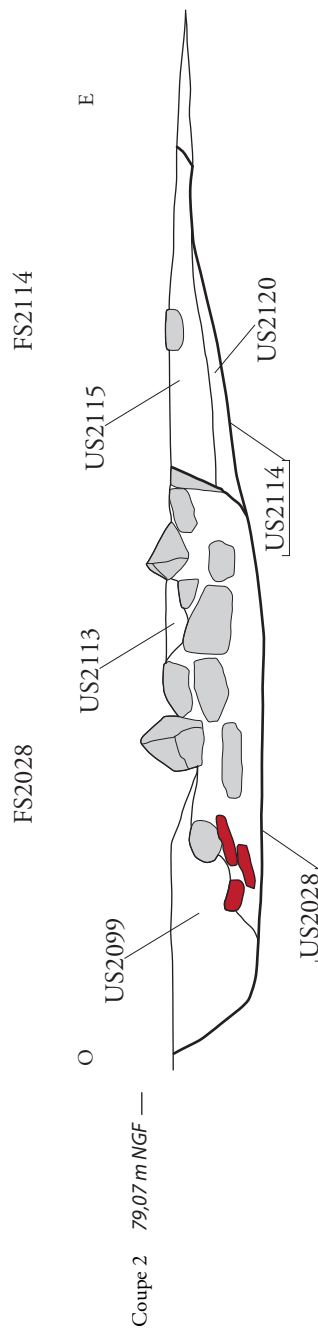
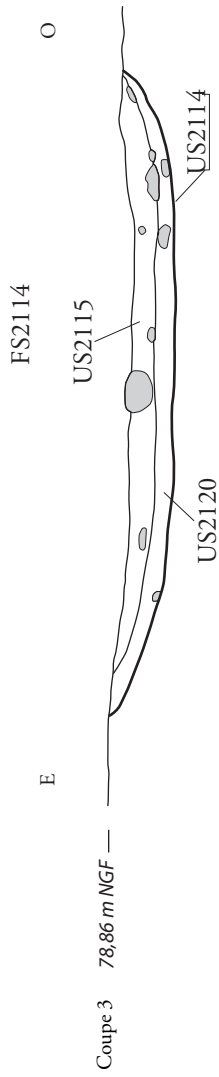


La Farlède (83)
 Projet de Centralité - Phases 1 et 2
 2013/2014 - 83 054 0028

Fig. 99 : Plan de localisation des sépultures SP2009, SP2010, SP2064, SP2067, SP2104, SP2105 et structures environnantes (éch. : 1/100).
 (DAO : D. Baldassari, J. Grasso).



Ech. 1/20
0 1 m

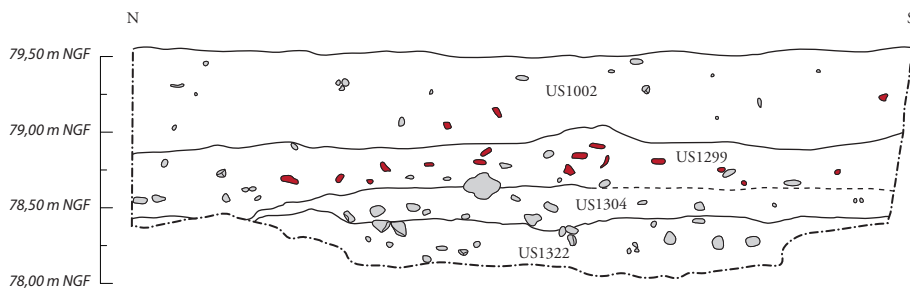


La Farliède (83)
Projet de Centralité - Phases 1 et 2
2013/2014 - 83 054 0028

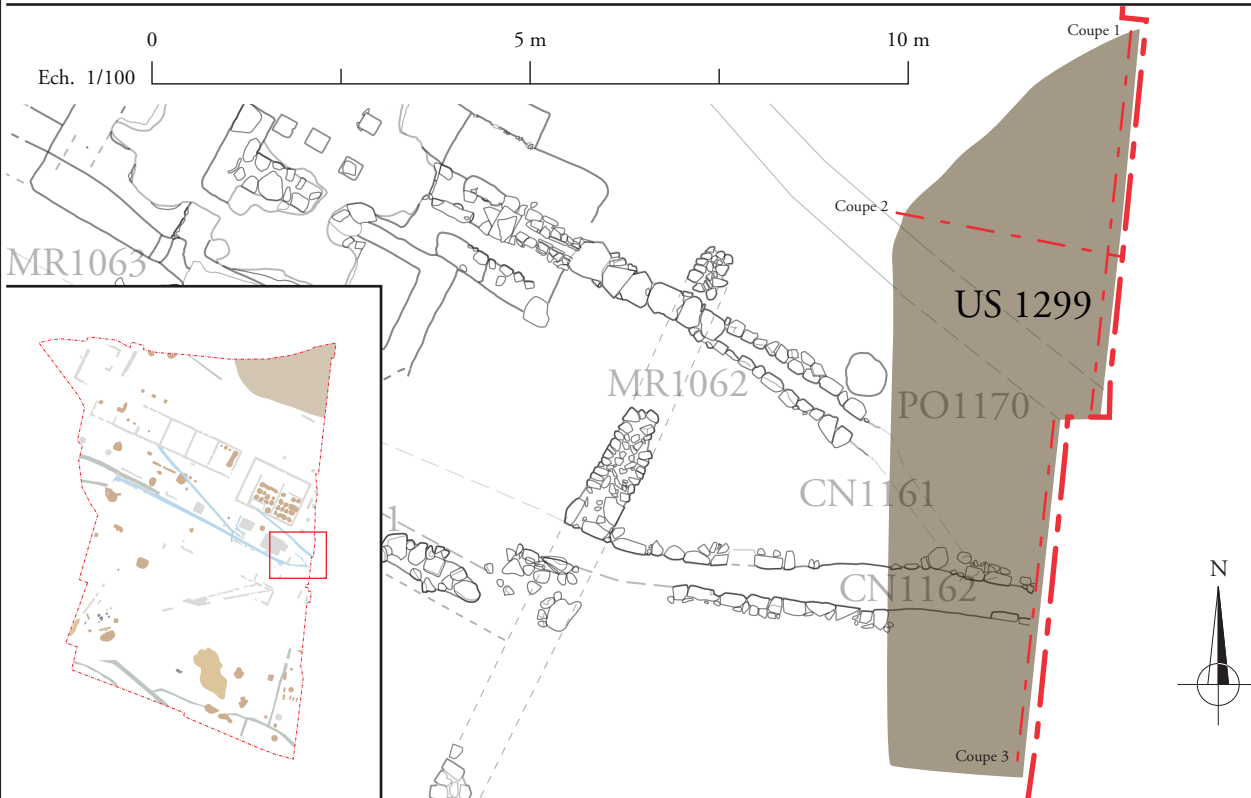
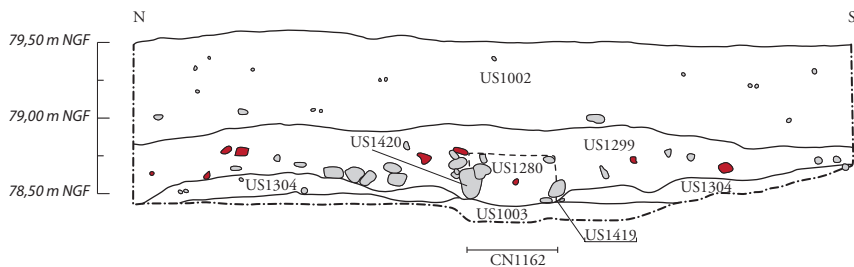
ARCHÉOLOGUM
INVESTIGATIONS ARCHÉOLOGIQUES

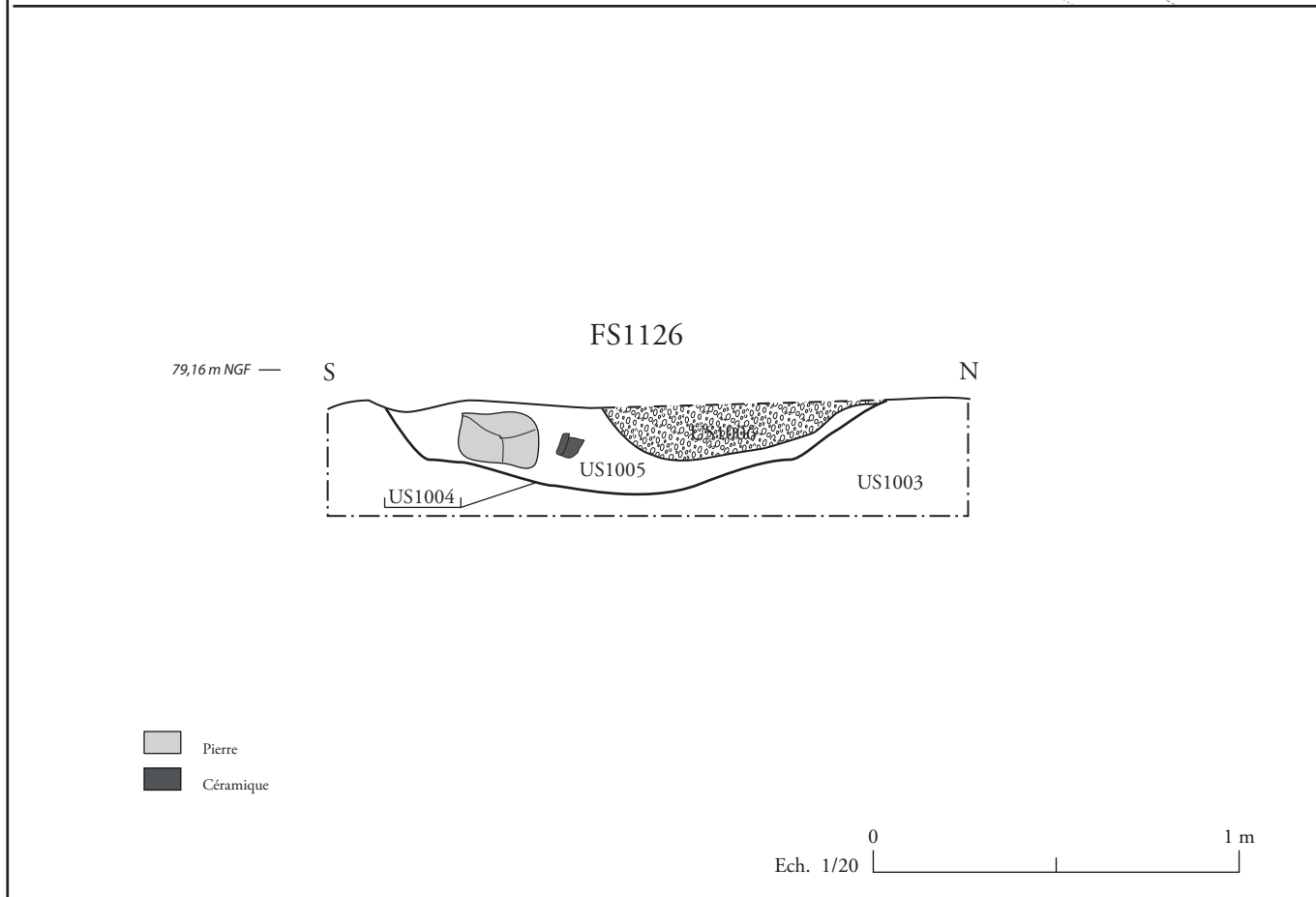
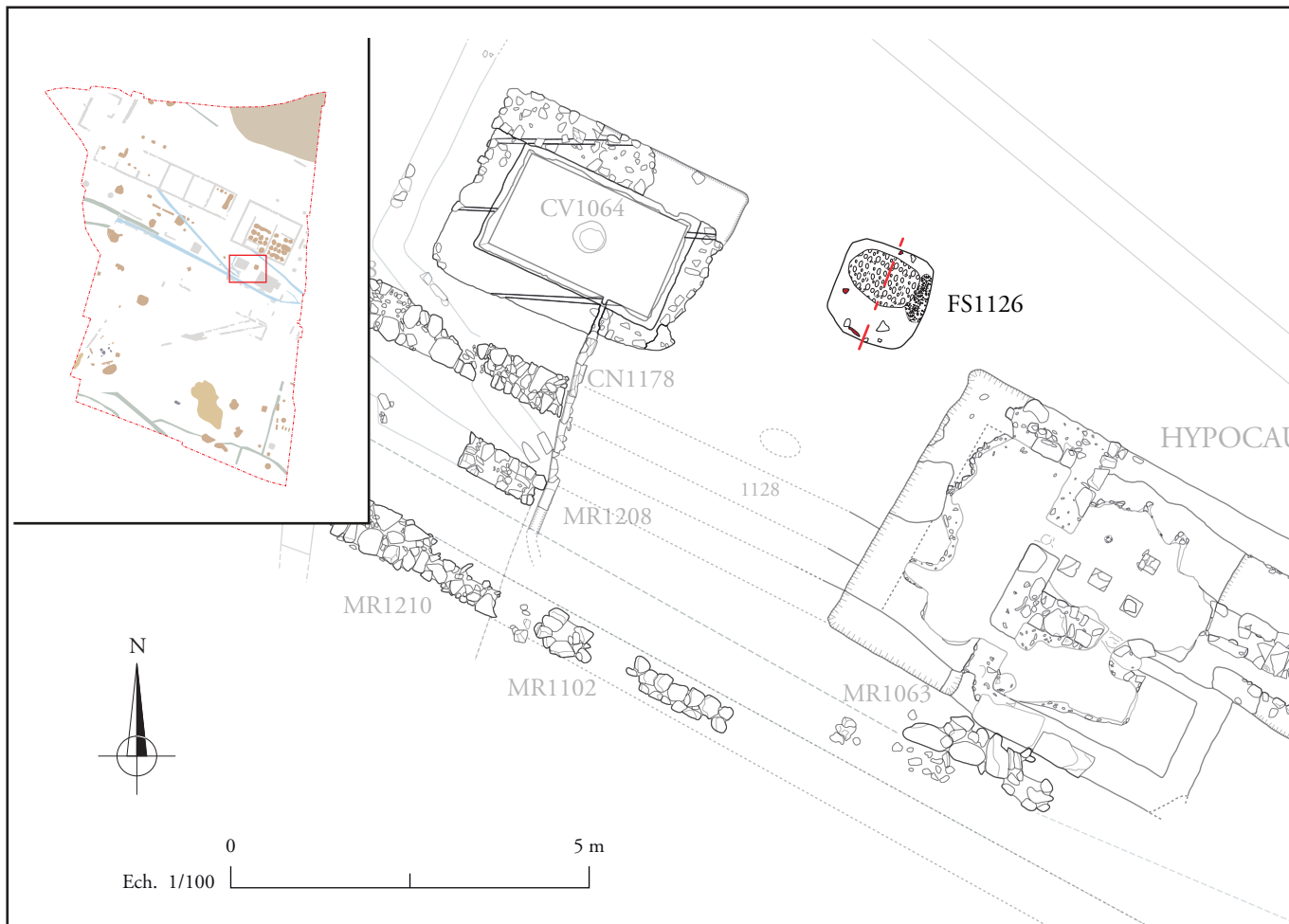
Fig. 100 : Plan de localisation et coupes des fosses FS2028 et FS2114 (éch. : 1/100 et 1/20). (DAO : D. Baldassari).

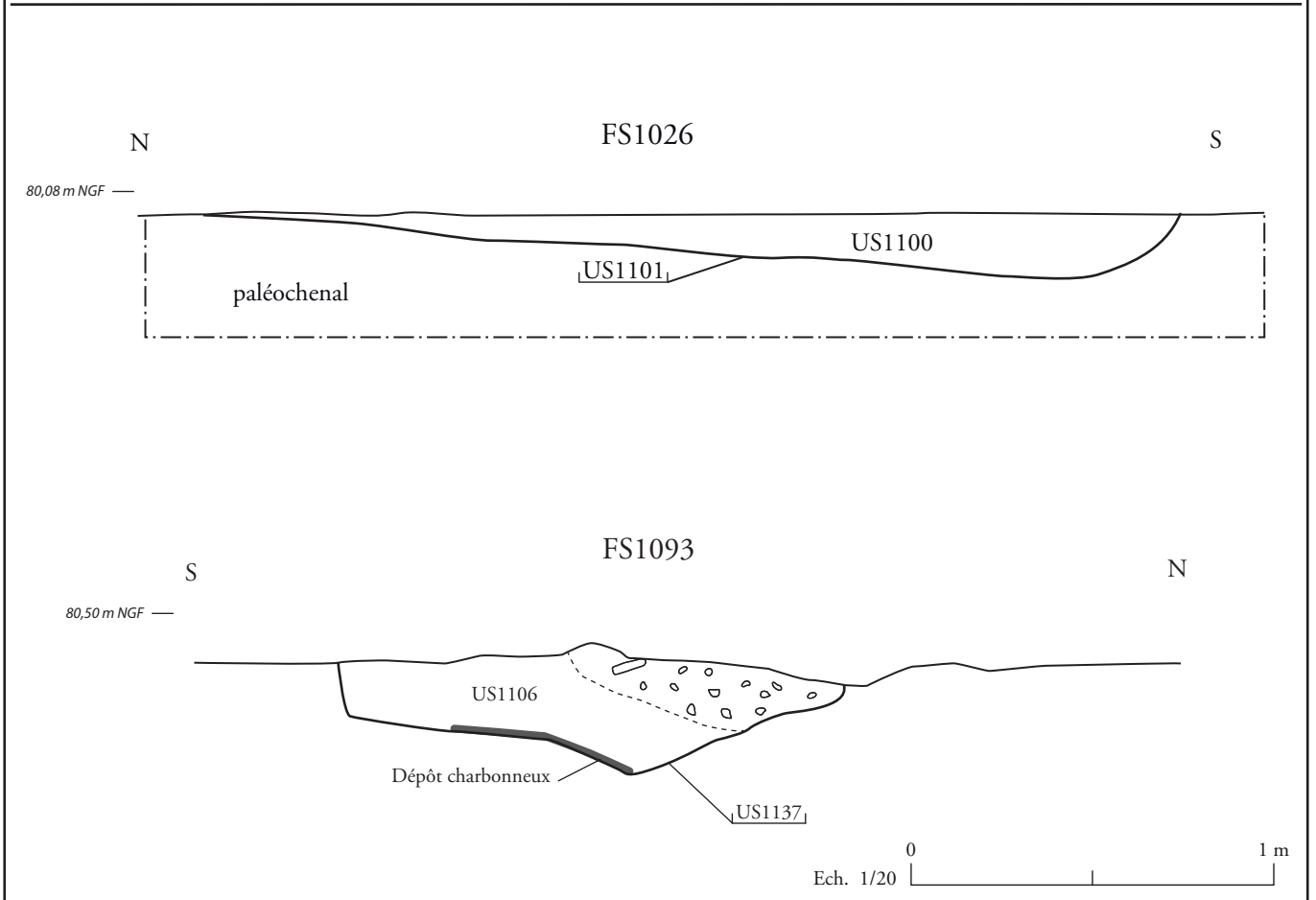
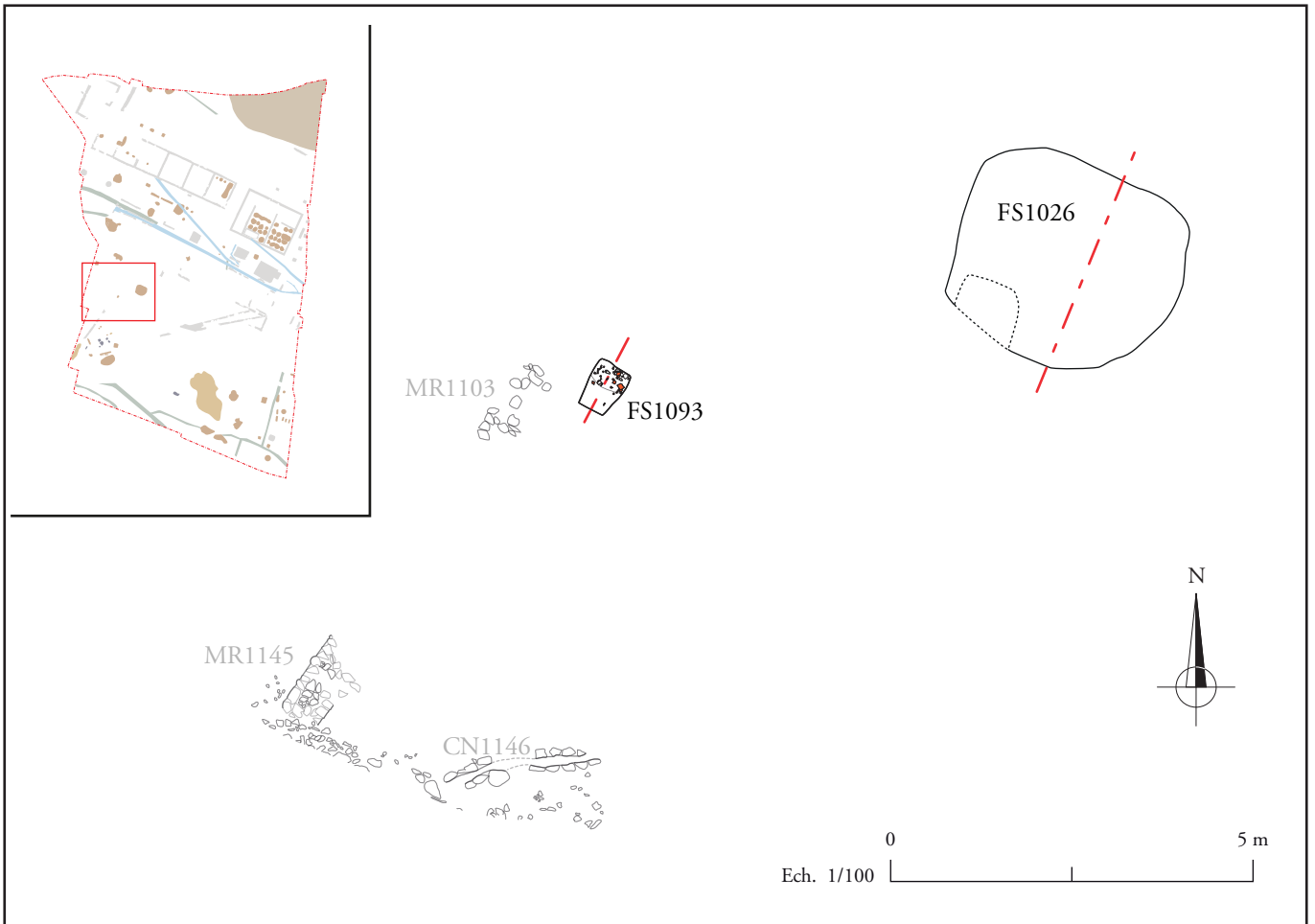
Coupe 1

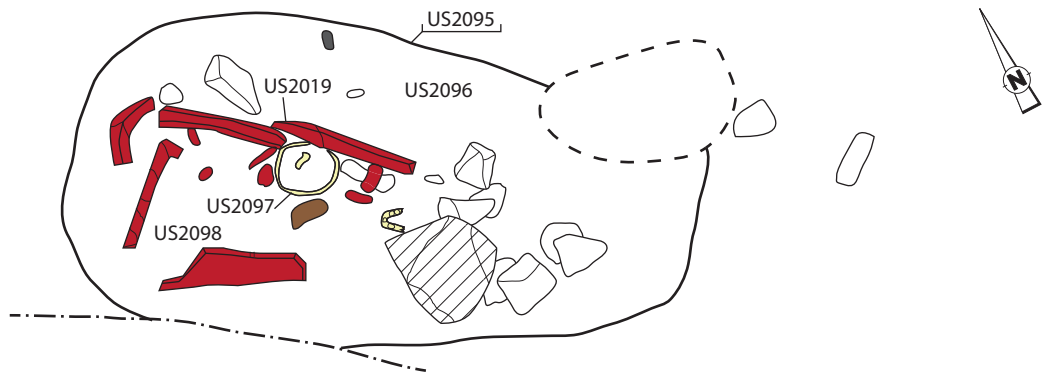


Coupe 3

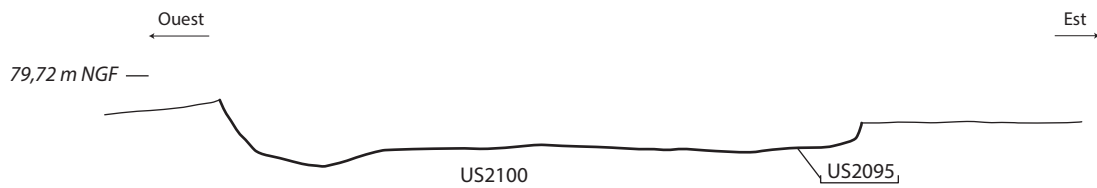




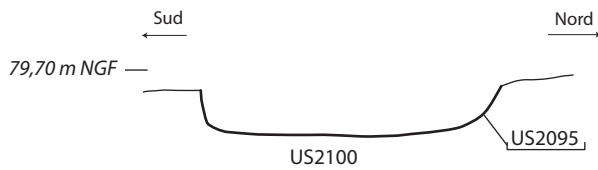




Profil longitudinal



Profil transversal



- Céramique
- Os (US 2097)
- TCA
- Dolium
- Schiste

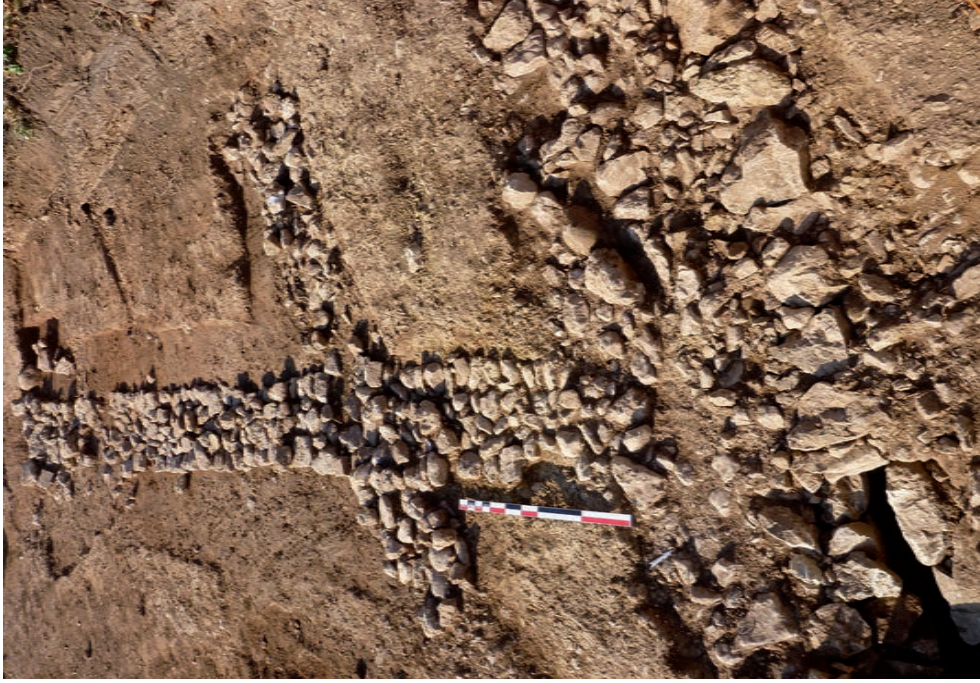
0 1/20 40 cm



Vue d'ensemble de la tombe



Vue rapprochée, vers l'ouest



La Farliède (83)

Projet de Centralité - Phases 1 et 2
2013/2014 - 83 054 0028

ARCHEODUNUM
INVESTIGATIONS ARCHÉOLOGIQUES

Fig. 105 : Vue en plan du drain-canal moderne CN1008/CN2005. Vue en plan du mur MR2007 coupé par le drain-canal CN1008/CN2005 et par le drain FO2008. (Clichés : Archeodunum).

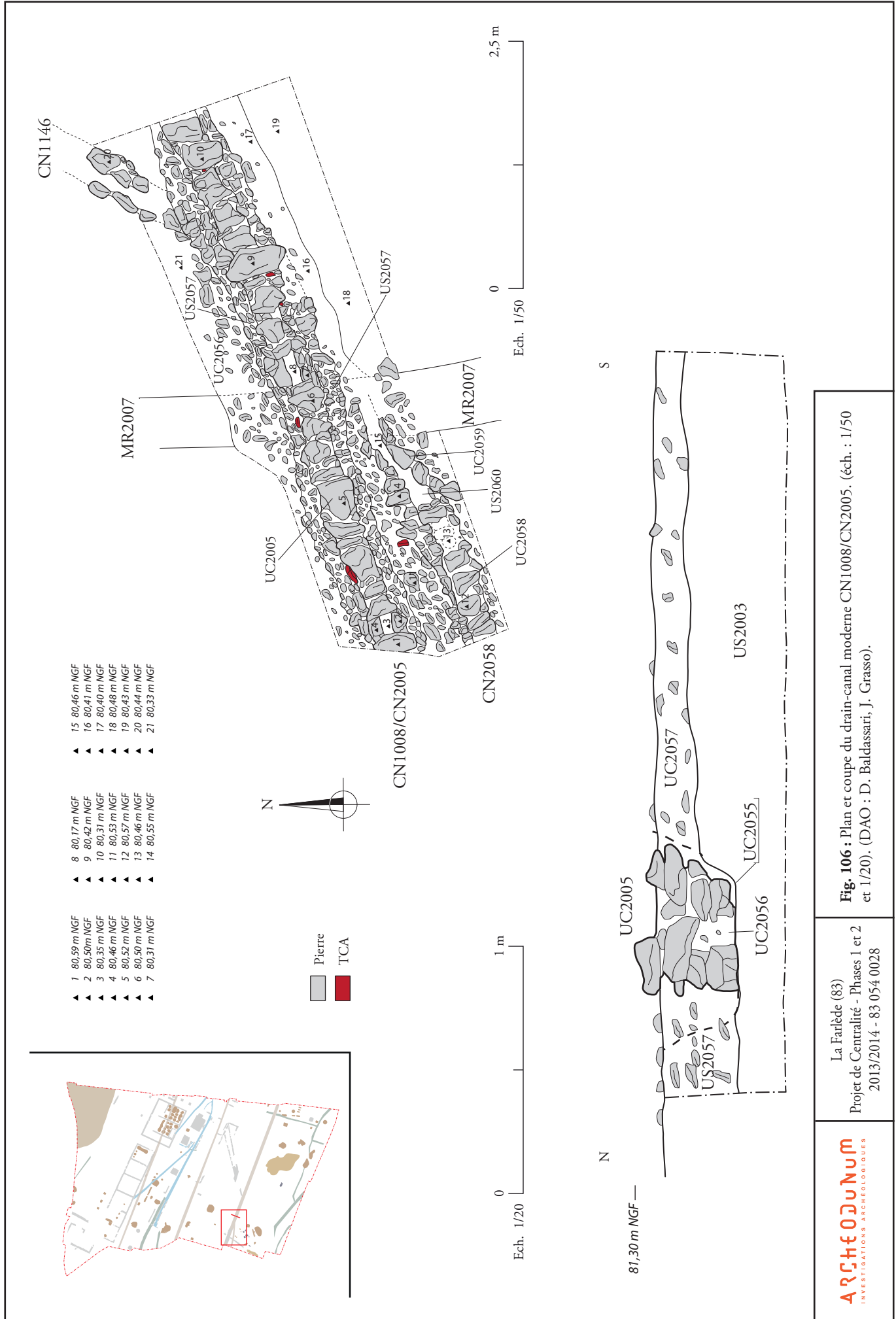
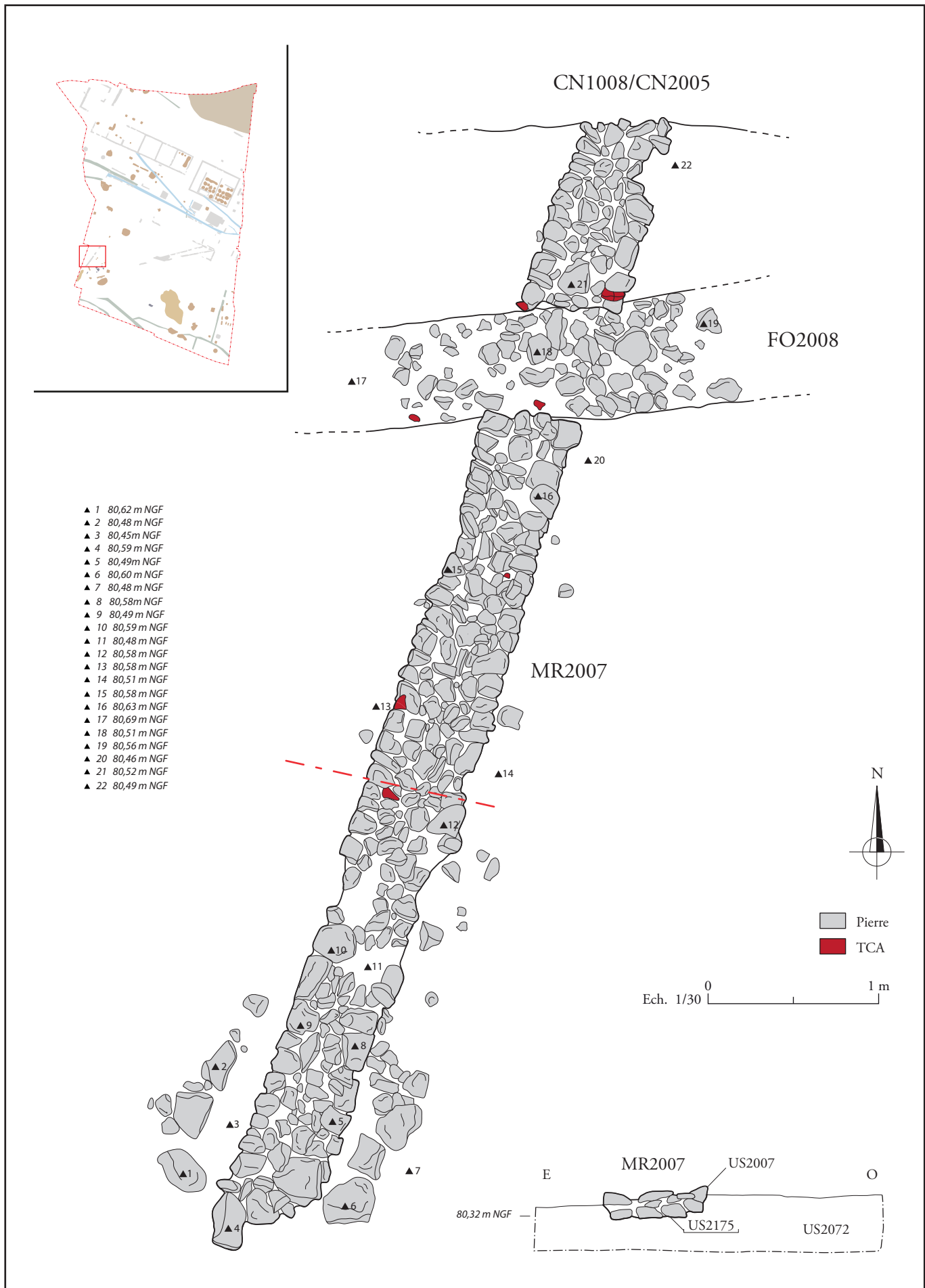
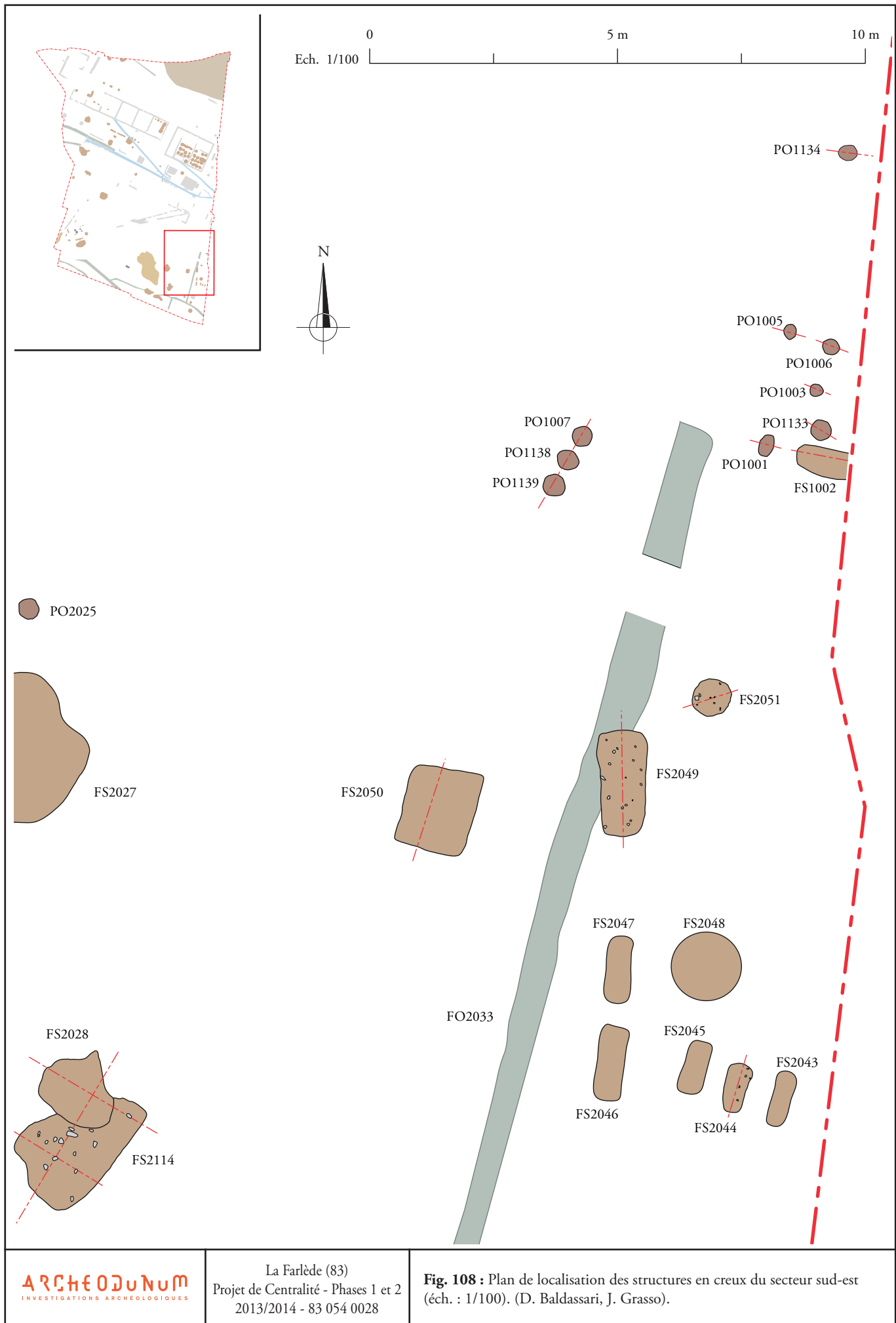
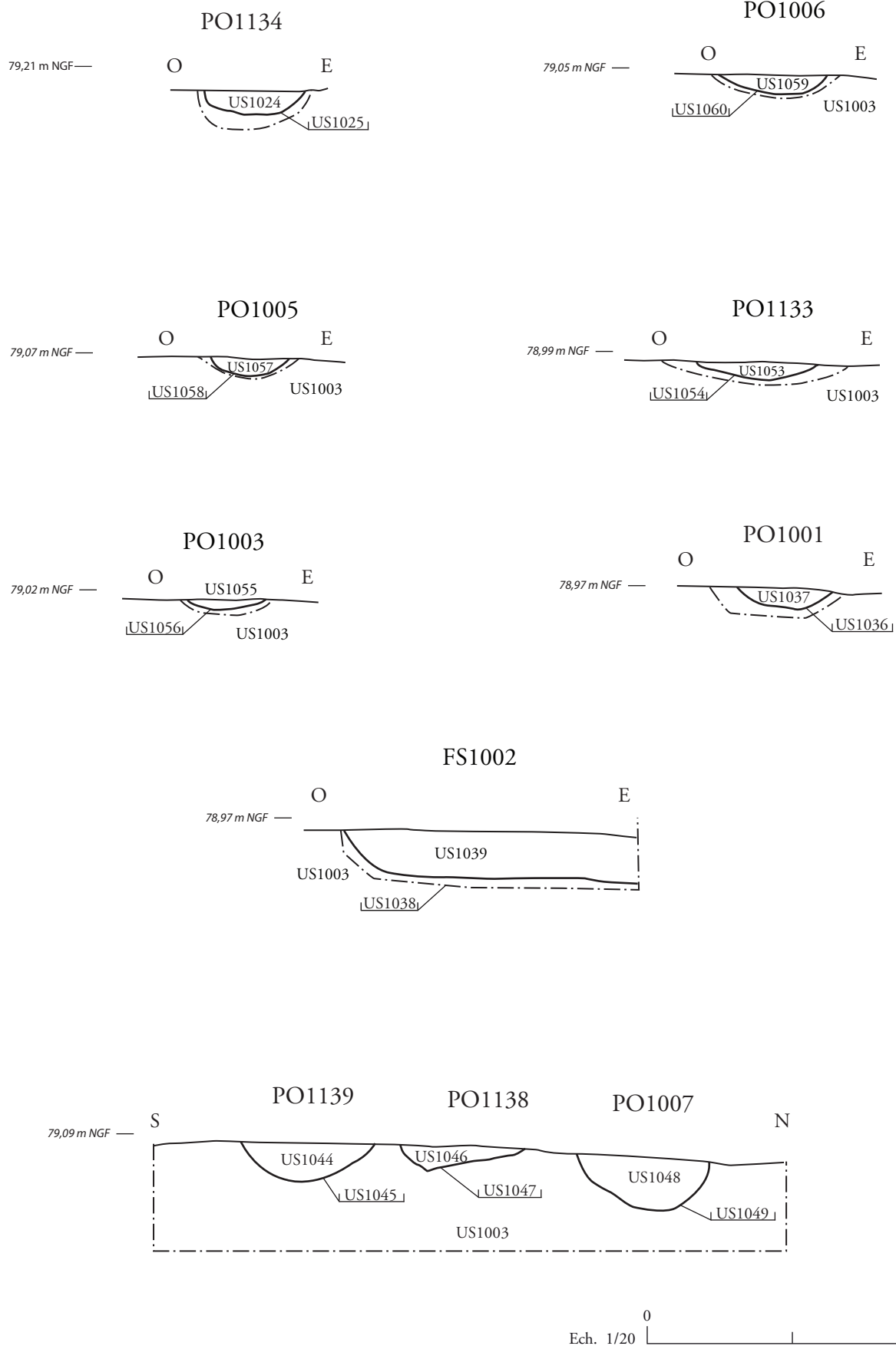


Fig. 106 : Plan et coupe du drain-canal moderne CN1008/CN2005. (éch. : 1/50 et 1/20). (DAO : D. Baldassari, J. Grasso).

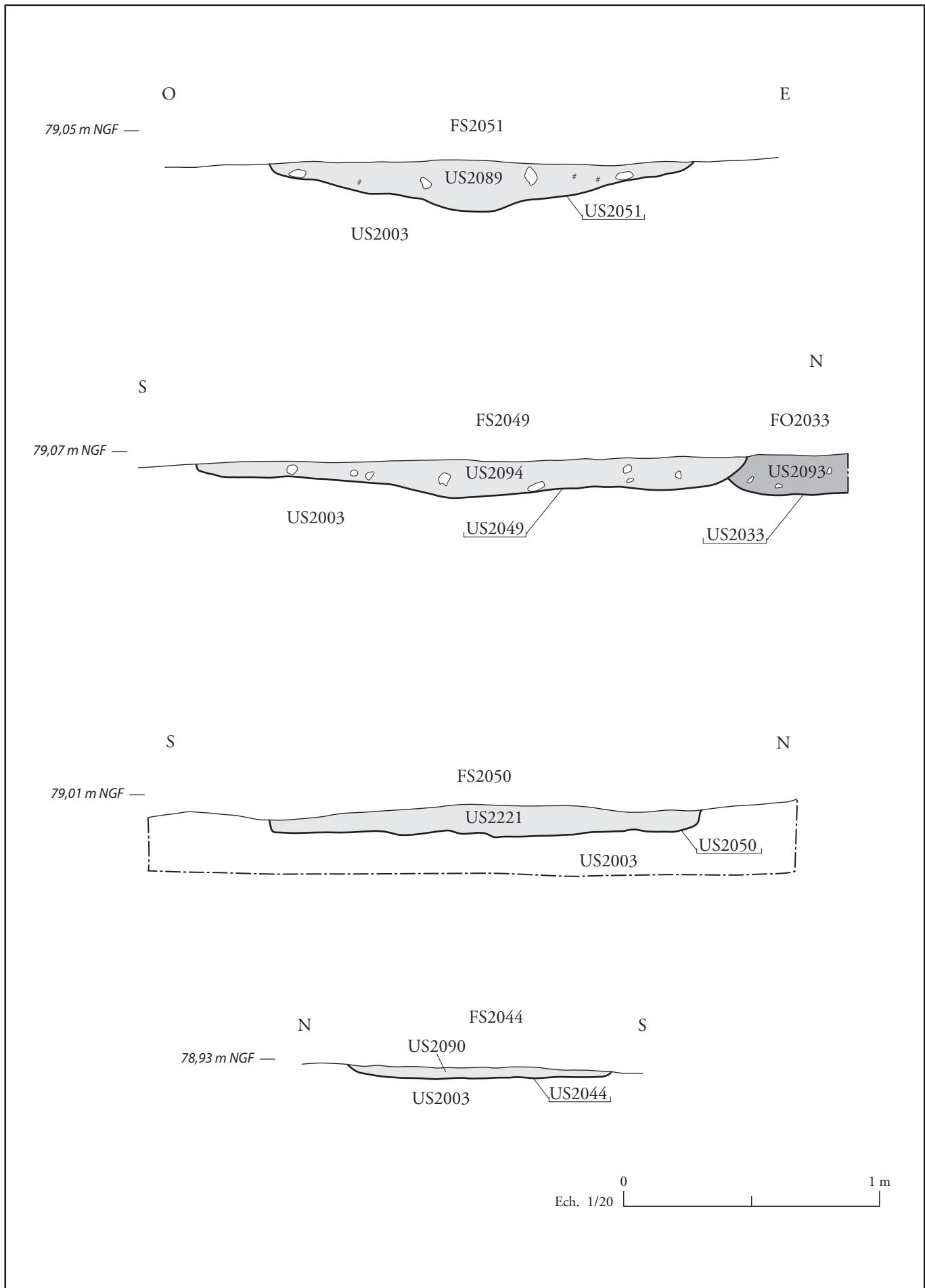
La Farliède (83)
 Projet de Centralité - Phases 1 et 2
 2013/2014 - 83 054 0028







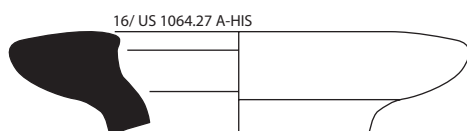
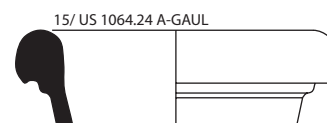
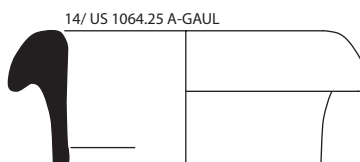
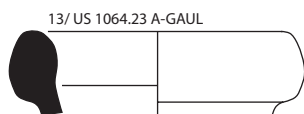
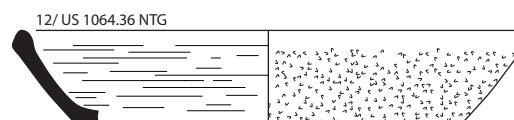
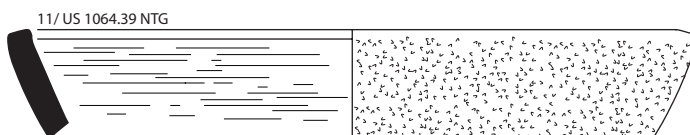
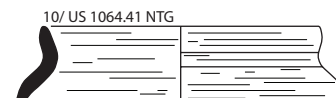
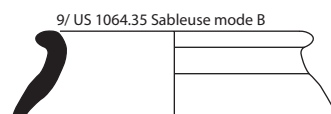
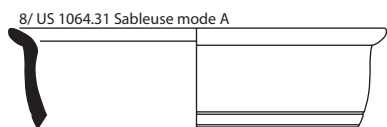
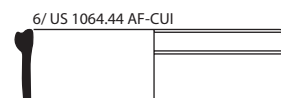
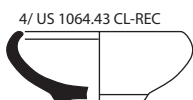
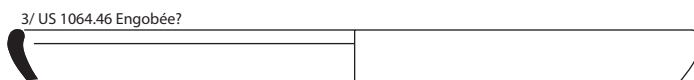
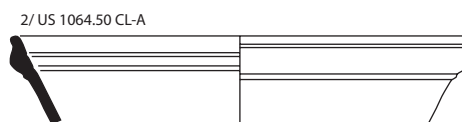
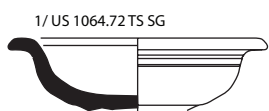
Ech. 1/20 0 1 m



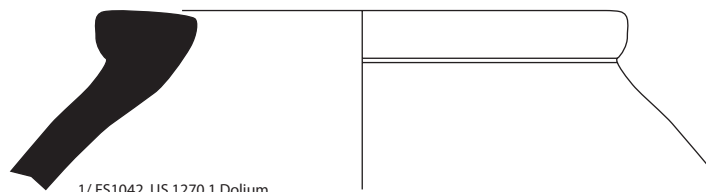
Liste des planches

- Planche 1 :** Mobilier céramique issu de la zone humide ZOH1081 (éch. 1/3). (DAO A. Gilles).
- Planche 2 :** Mobilier céramique issu des bâtiments 2, 3 et 4 (éch. 1/3). (DAO A. Gilles).
- Planche 3 :** Mobilier céramique issu de l'abandon de l'hypocauste et du comblement des puits PT1117 et PT1149 (éch. 1/3). (DAO A. Gilles).
- Planche 4 :** Mobilier céramique issu des couches rattachées au collecteur CN1113 (éch. 1/3). (DAO A. Gilles).
- Planche 5 :** Mobilier céramique issu du comblement de la fosse FS1068 (éch. 1/3). (DAO A. Gilles).
- Planche 6 :** Mobilier céramique issu du comblement de la fosse FS1068 (éch. 1/3). (DAO A. Gilles).
- Planche 7 :** Mobilier céramique issu du comblement de la fosse FS1068 (éch.1/3). (DAO A. Gilles).
- Planche 8 :** Mobilier céramique issu du comblement du fossé FO1148 (éch. 1/3). (DAO A Gilles).
- Planche 9 :** Mobilier céramique issu de la fosse FS1081 (éch. 1/3). (DAO A. Gilles).
- Planche 10 :** Mobilier céramique issu de structures isolées (éch. 1/3). (DAO A. Gilles).
- Planche 11 :** Mobilier céramique issu de structures isolées (éch. 1/3). (DAO A. Gilles).
- Planche 12 :** Mobilier céramique issu de structures isolées (éch. 1/3). (DAO A. Gilles).
- Planche 13 :** Mobilier issu des fosses FS1026 et FS1126 (éch. 1/3). (DAO A. Gilles).
- Planche 14 :** Verre état 1 (éch. 1/2). (DAO : A. Colombier-Gougouzian).
- Planche 15 :** Verre états 1 et 2 (éch. 1/2). (DAO : A. Colombier-Gougouzian).
- Planche 16 :** Monnaies antiques, modernes et contemporaines (éch. 1/1). (DAO : J. Collombet).
- Planche 17 :** Le mobilier en os (éch. 1/1). (Dessins et DAO : J. Collombet).
- Planche 18 :** Bassin en alliage cuivreux 1231.2 (éch. 1/2) et l'anse associée 1231.1 (éch. 1/1). (Dessins et DAO : J. Collombet ; cliché : J. Grasso).
- Planche 19 :** Le mobilier en alliage cuivreux (éch. 1/1, sauf mention contraire.). (Dessins et DAO : J. Collombet).
- Planche 20 :** Le mobilier en plomb (éch. 1/1 : 1130.1) et 1/2 : 1295.1). (Dessins et DAO : J. Collombet).
- Planche 21 :** Le mobilier en fer (éch. 1/1). D'après radiographie pour 1114.1 et 1198.1. (Dessins et DAO : J. Collombet).
- Planche 22 :** Le mobilier en terre cuite (éch. 1/3). (Clichés et DAO : A. Gilles)
- Planche 23 :** *Tegulae* et *imbrices* de type I (I^{er}-II^e siècle apr. J.-C.) (éch. 1/6). (DAO : B. Clément).
- Planche 24 :** a, pilette en terre cuite ; b, *tegulae* de type II (IV^e-VI^e siècle apr. J.-C.) (éch. 1/6). (DAO : B. Clément).
- Planche 25 :** Enduits peints : fragments selon inventaire. (Clichés : S. Dufaud).
- Planche 26 :** Relevé photographique du contrepois de pressoir (Type 1), remployé dans la fondation du mur MR1215 (éch. 1/10). (Infographie : A. Collet).

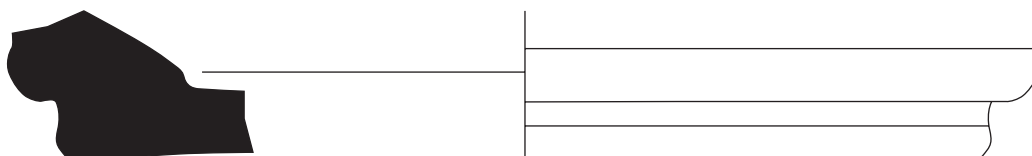
PLANCHES



Ech 1:3
0 15 cm

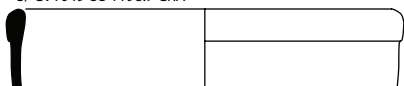


1/ FS1042, US 1270.1 Dolium



2/ FS1042, US 1270 Dolium

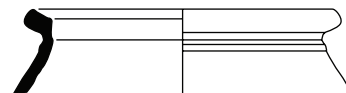
3/ CV1049 US 1198.7 CRA



4/ MR1056 US 1202.3 CL-D



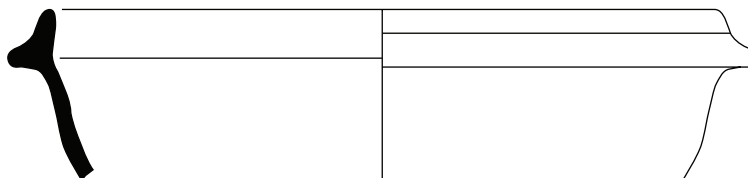
5/ CV1049 US 1198.3 Sableuse mode A



6/ CV1049 US 1198.2 Sableuse mode A



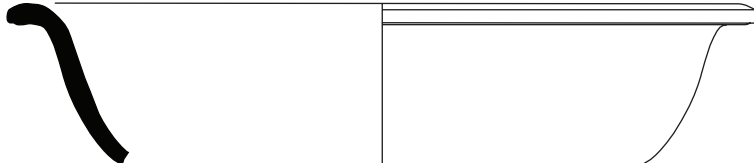
7/ CV1049 US 1198.1 Sableuse mode A



Ech 1:3

0 15 cm

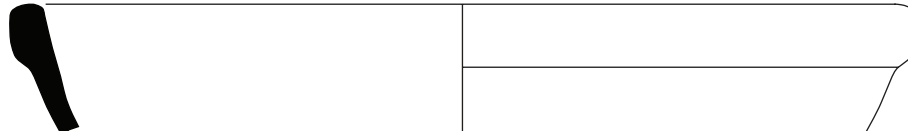
8/ CV1049 US 1198.5 Sableuse mode A



9/ CV1049 US 1198.4 Sableuse mode A



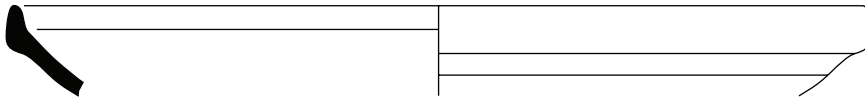
10/ MR1056 US 1202.2



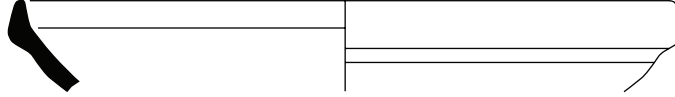
11/ MR1062.2 AF-CUI



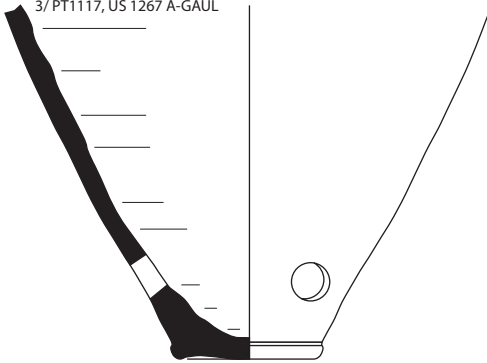
1/ MR1096 US 1085.2 CL-D



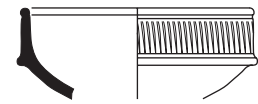
2/ MR1096 US 1085.3 CL-D



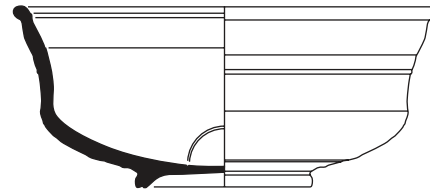
3/ PT1117, US 1267 A-GAUL



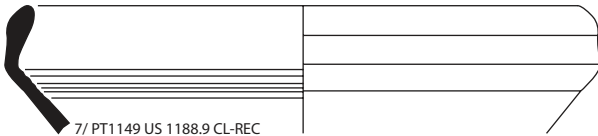
4/ PT1149, US 1188.17 TS SG



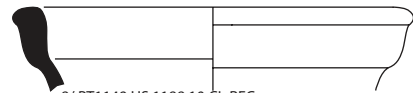
5/ PT1149 US 1188.19 TS SG



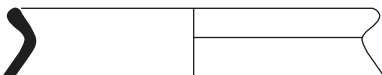
6/ PT1149 US 1187.18 TS SG



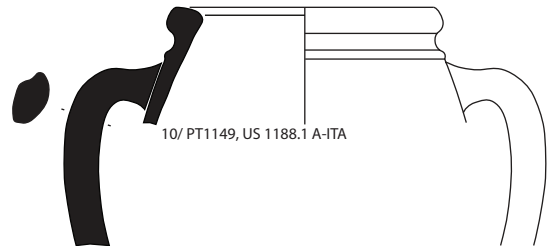
7/ PT1149 US 1188.9 CL-REC



8/ PT1149 US 1188.10 CL-REC



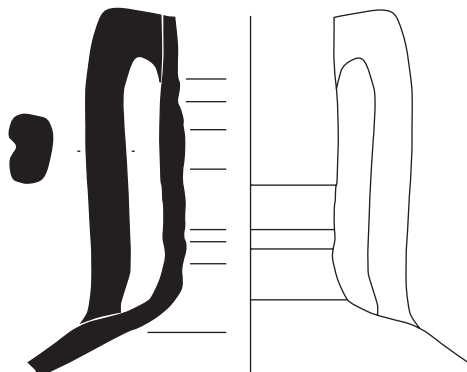
9/ PT1149 US 1188.13 CL-REC



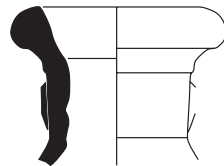
10/ PT1149, US 1188.1 A-ITA

Ech 1:3

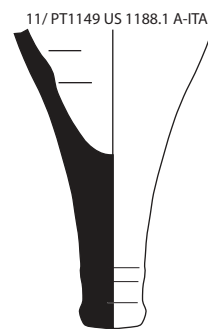
0 15 cm



12/ PT1149, US 1188.3 A-Non id.

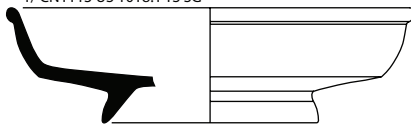


13/ PT1149, US 1188.2 A-GAUL

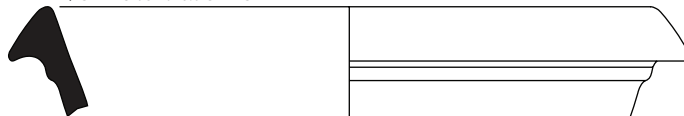


11/ PT1149 US 1188.1 A-ITA

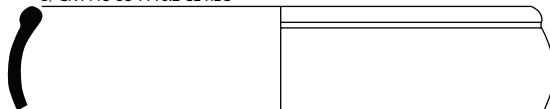
1/ CN1113 US 1018.1 TS SG



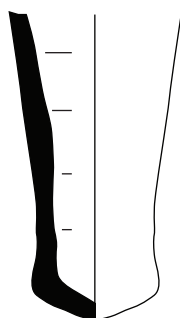
2/ CN1113 US 1018.6 CL-REC



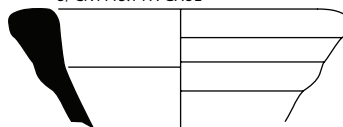
3/ CN1113 US 1116.2 CL-REC



4/ CN1113.15 A-GAUL



5/ CN1113.14 A-GAUL

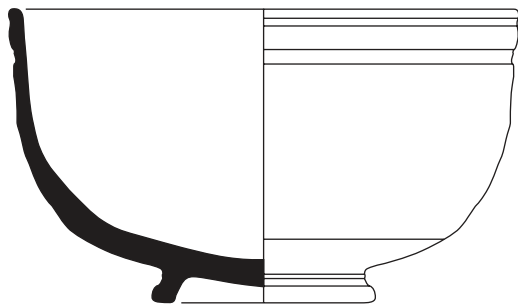


Ech 1:3

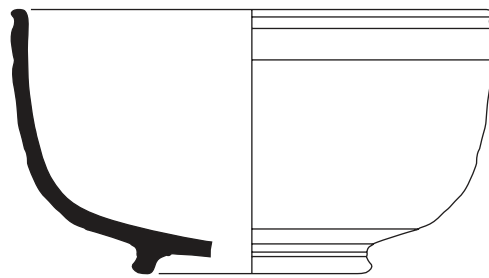
0

15 cm

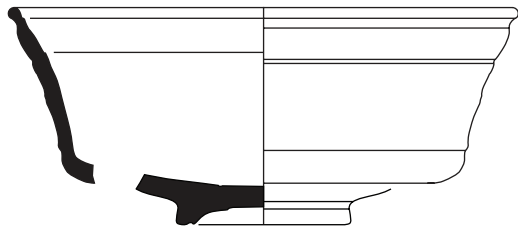




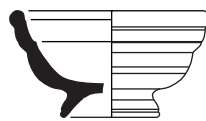
1/ FS1068 US 1249.50 TS SG



2/ FS1068 US 1249.47 TS SG



3/ FS1068 US 1249.33 TS SG



4/ FS1068 US 1249.35 TS SG

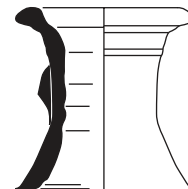
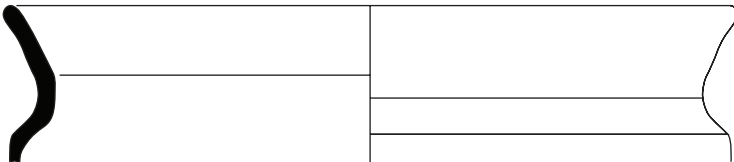


5/ FS1068 US 1249.22 NTG



6/ FS1068 US 1249.21 NTG

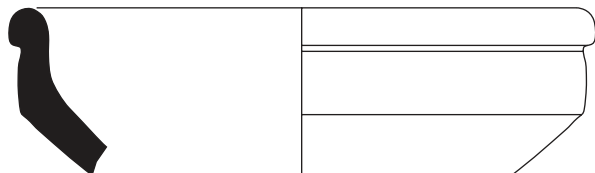
7/ FS1068 US 1249.20 NTG



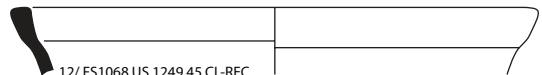
8/ FS1068 US 1249.52 non id.



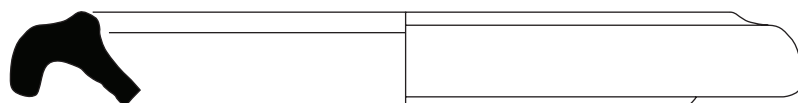
9/ FS1068 US 1249.52 Non id.



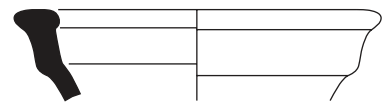
10/ FS1068 US 1249.41 CL-REC



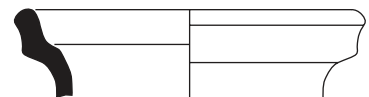
12/ FS1068 US 1249.45 CL-REC



11/ FS1068 US 1249.39 CL-REC



13/ FS1068 US 1249.51 CL-REC



14/ FS1068 US 1249.45 CL-REC

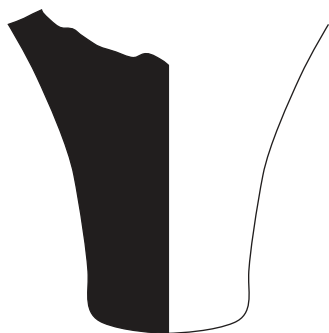


16/ FS1068 US 1249.40 CL-REC

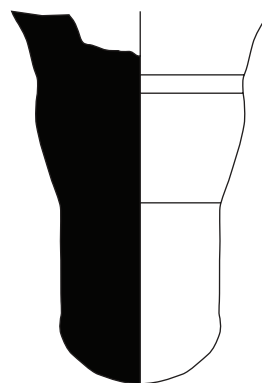


15/ FS1068 US 1249.42 CL-REC

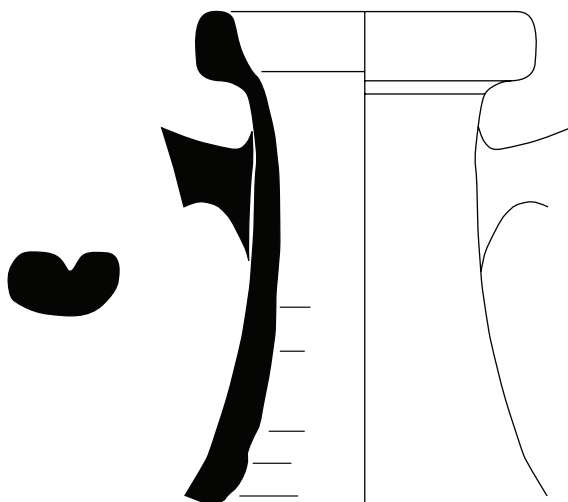
Ech 1:3
0 15 cm



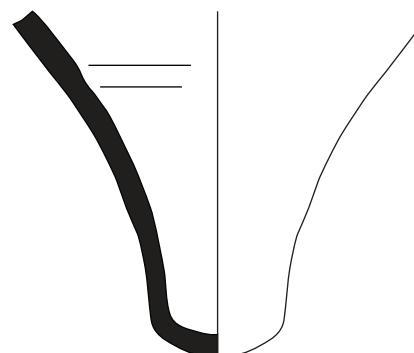
1/ FS1068 US 1249.1 A-TAR



2/ FS1068 US 1249.3 A-TAR

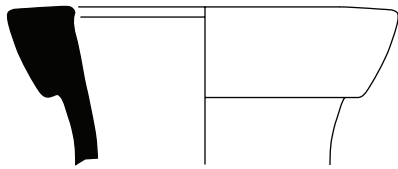


3/ FS1068 US 1249.6 A-non id.

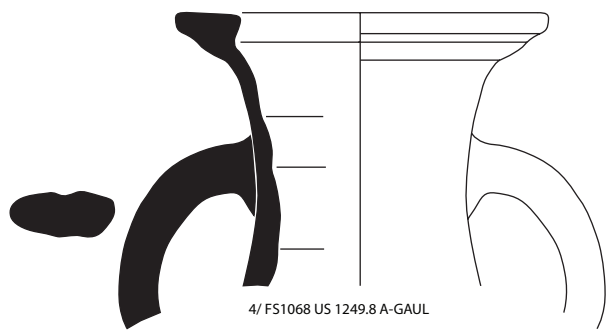


4/ FS1068 US 1249.5 A-GAUL?

Ech 1:3
0 15 cm



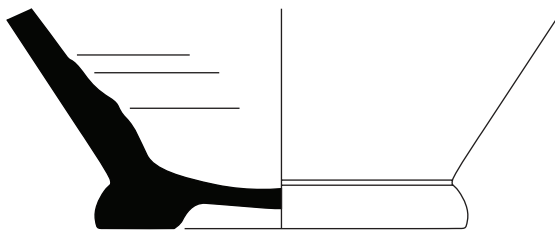
1/ FS1068 US 1249.13 A-GAUL



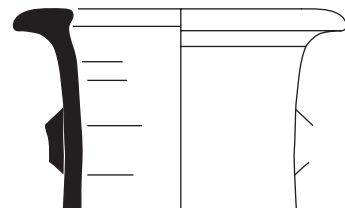
4/ FS1068 US 1249.8 A-GAUL



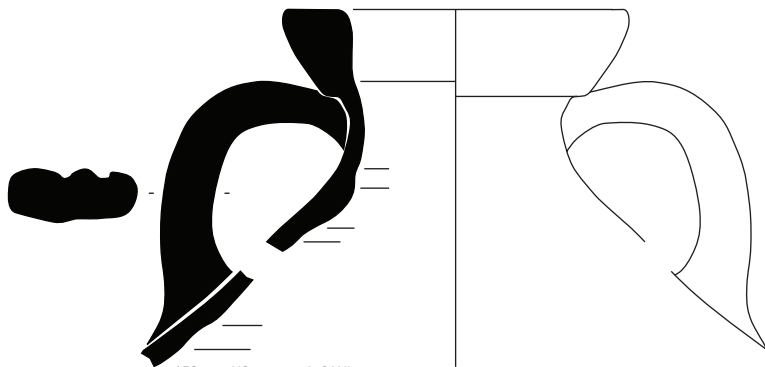
2/ FS1068 US 1249 A-GAUL



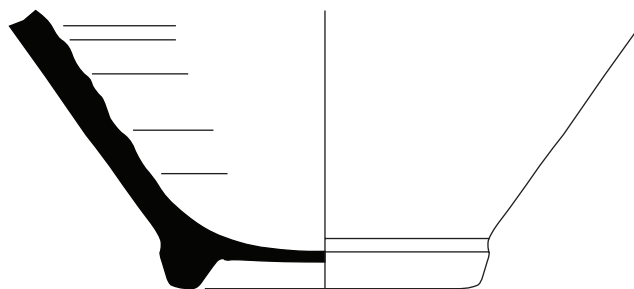
3/ FS1068 US 1249.14 A-GAUL



5/ FS1068 US 1249.7 A-GAUL



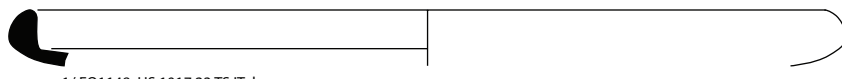
6/ FS1068 US 1249.26 A-GAUL



7/ FS1068 US 1249.18 A-GAUL

Ech 1:3
0 15 cm

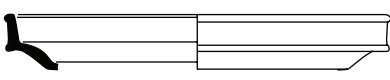
Planche 7



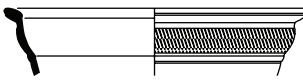
1/ FO1148, US 1017.23 TS Ital.



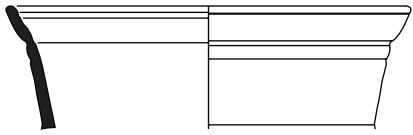
4/ FO148, US 1017.25 TS ital



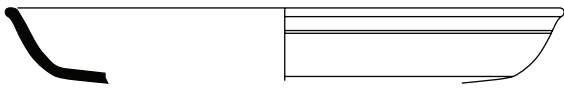
2/ FO1148, US 1017.26 TS Ital.



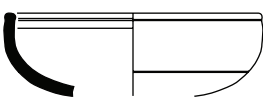
3/ FO1148, US 1017.24 TS Ital.



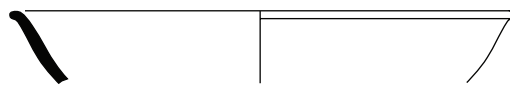
5/ FO1148, US 1017.18 TS SG



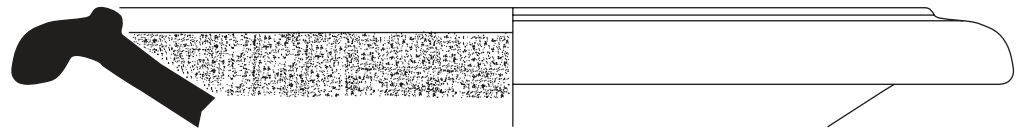
6/ FO1148, US 1017.35 TS SG



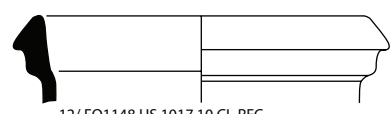
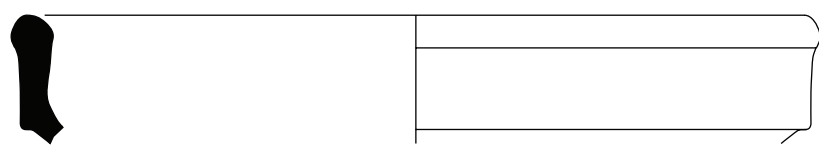
7/ FO1148, US 1017.19 TS SG



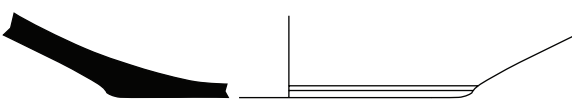
8/ FO1148 US 1017.13 Cl. engobée



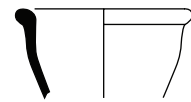
9/ FO1148 US 1017.4 CL-REC



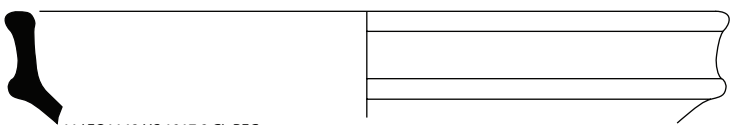
12/ FO1148 US 1017.10 CL-REC



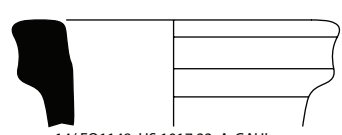
10/ FO1148 US 1017.3 CL-REC



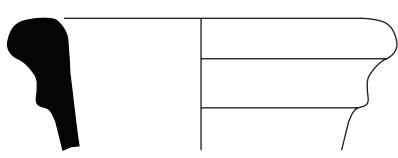
13/ FO1148 US 1017.14 CL-REC



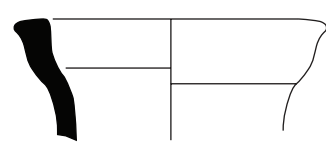
11/ FO1148 US 1017.9 CL-REC



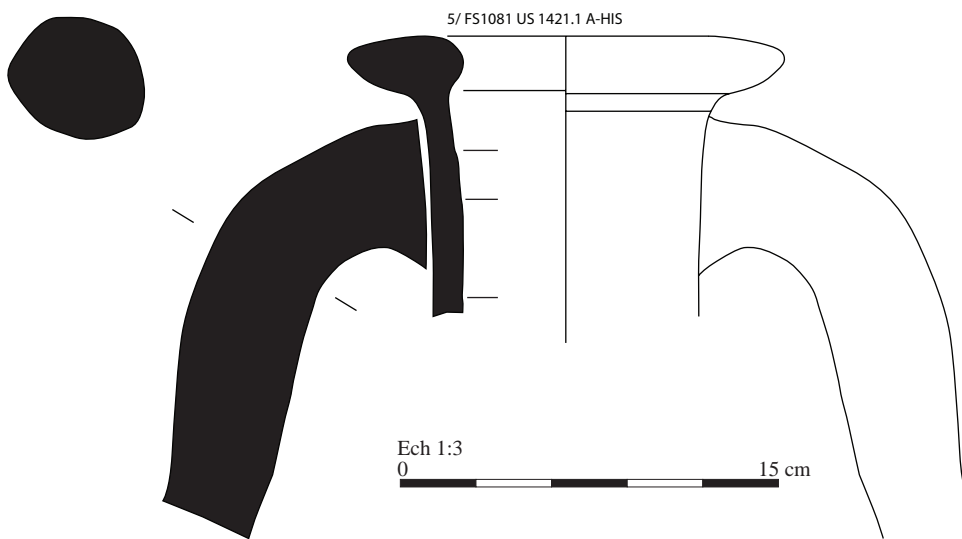
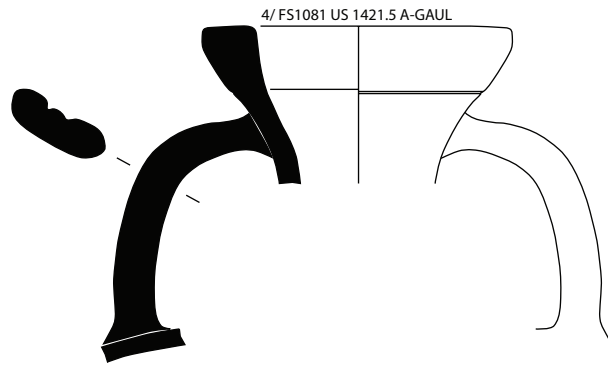
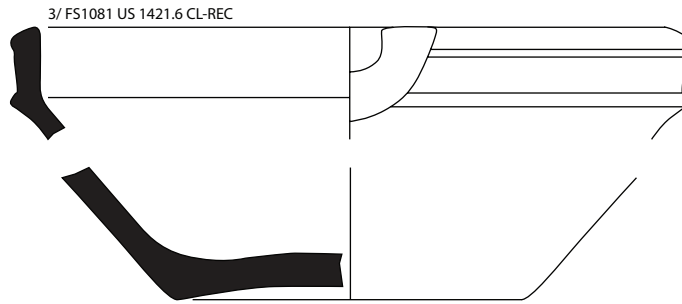
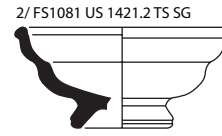
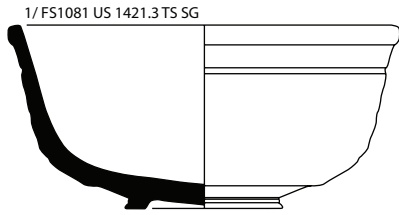
14/ FO1148, US 1017.33. A-GAUL



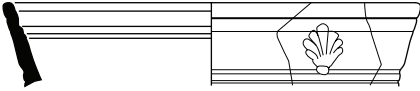
15/ FO1148 US 1017.31 A-GAUL



16/ FO1148, US 1017.32 CL-REC



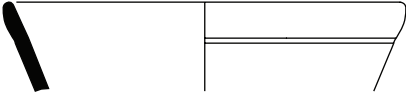
1/ FS1114 US 1113.20 TS Ital.



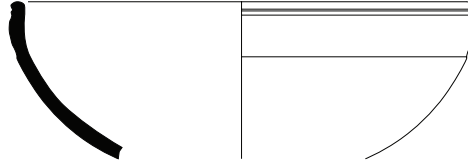
US 2023/2101.5 Cl-A?



2/ FS1093 US 1106.2 TS Ital.



3/ US 1413.11 TS SG



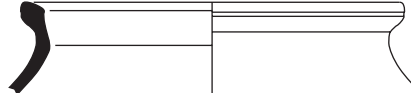
3/ FS2114 US 2115.2 Carré C PF



4/ FS2114 US 2115.2 Carré C CL-REC



5/ FS2028 US 2099.5 Sabl. mode B



6/ FS2028 US 2119 .1 Grise KAOL



7/ FS2028 US 2099.6 Sabl. mode A



8/ US 2116.1 AF-CUI



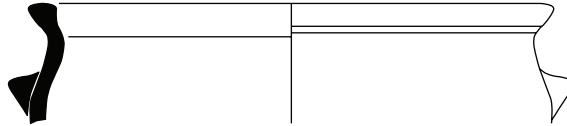
9/ FS2114 US 2115.1 AF-CUI



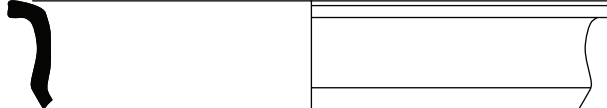
10/ FS1111 US 1225.4 NTG



11/ US 2025/2101.1 CC-Non id.



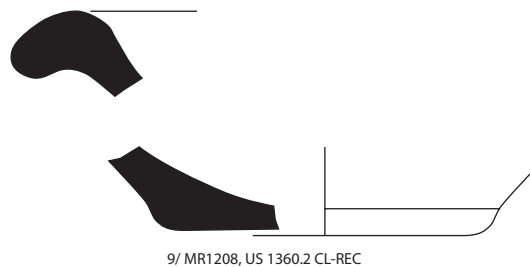
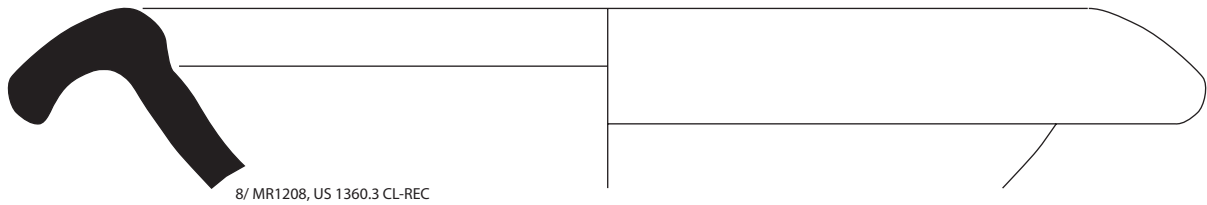
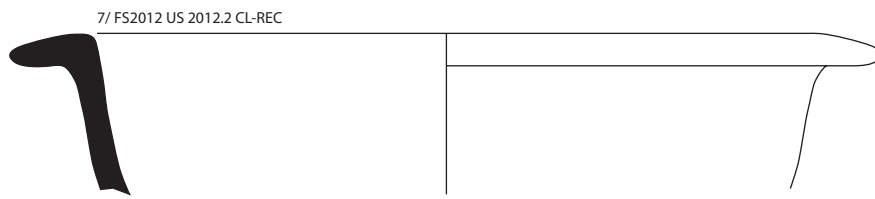
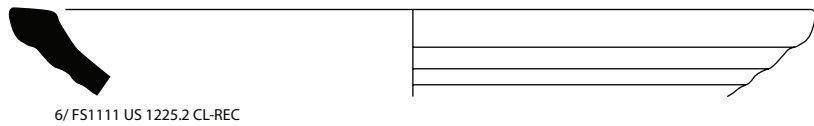
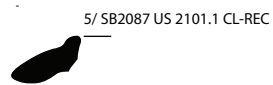
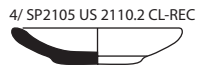
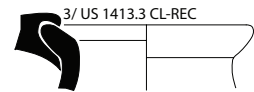
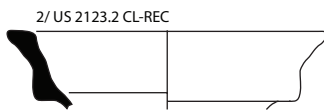
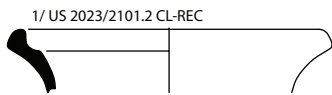
12/ SL1132 US 1022.1 non id. pâte brune



Ech 1:3

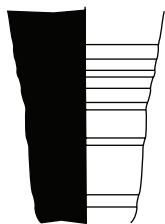
0

15 cm

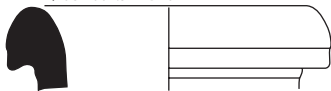


Ech 1:3
0 15 cm

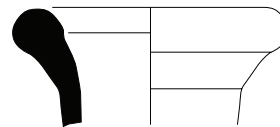
1/ FS2012.1 A-GAUL



2/ US 2001.5 A-GAUL



3/ US 2023/2101.3 A-GAUL



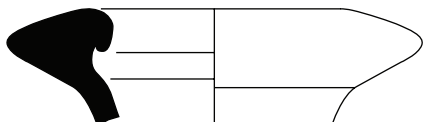
4/ US 2023/2101.4 A-GAUL



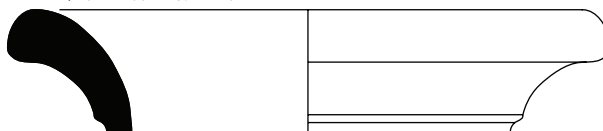
5/ US 2006 N° 2 A-GAUL



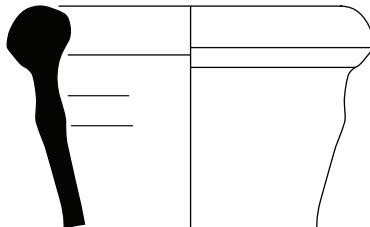
6/ SL1132 US 1021.1 Non id.



7/ FS1111 US 1225.1 A-HIS



9/ FS1114 US 1113.1 A-TAR



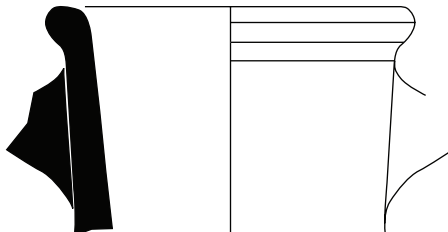
8/ CV1064 US1193.1 A-ORI

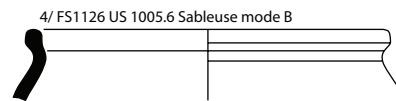
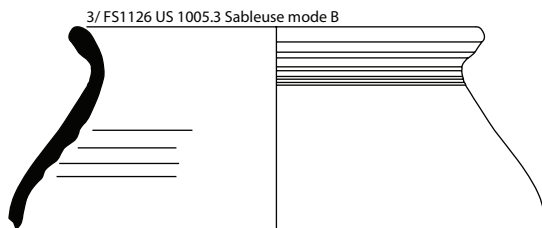
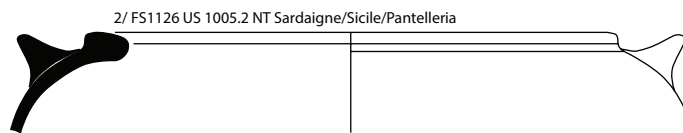
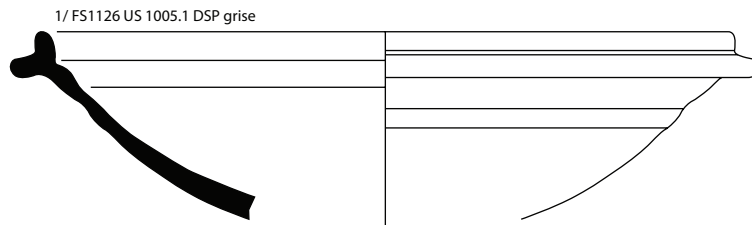


Ech 1:3

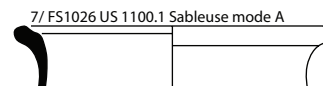
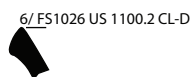
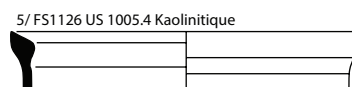
0 15 cm

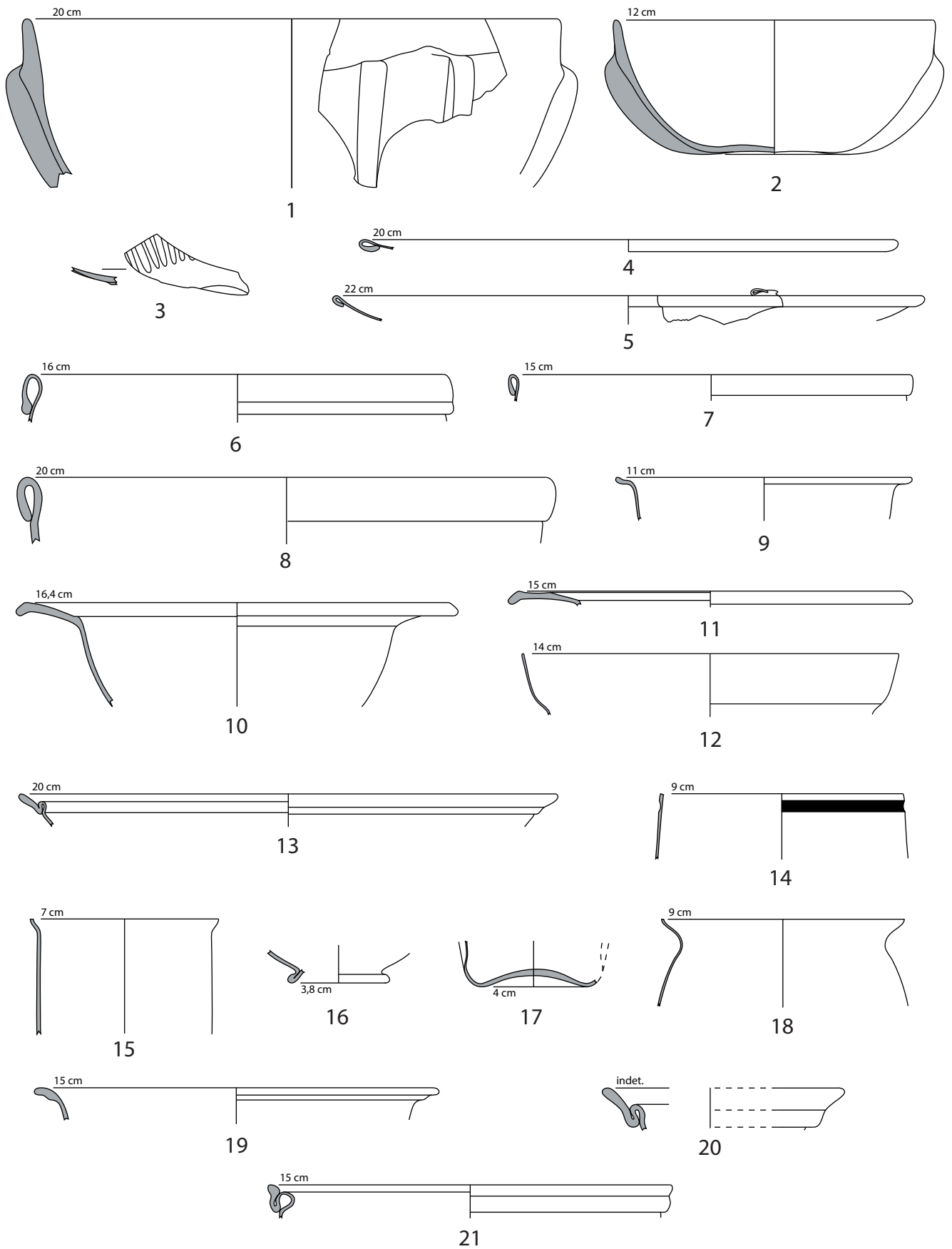
10/ FS1114 US 1113.2 A-Non id.

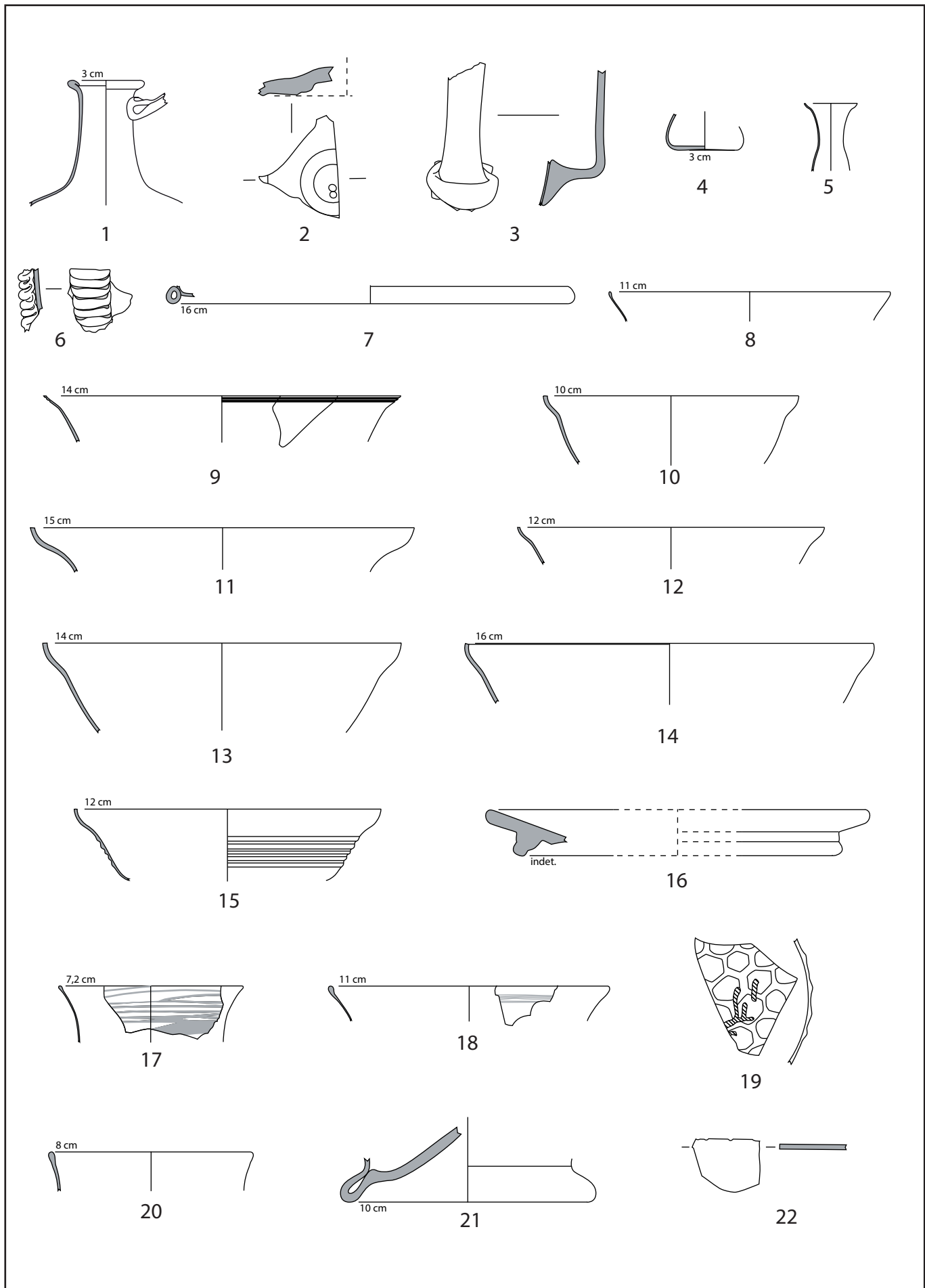




Ech 1:3
0 15 cm







ANTIQUITE
(Haut-Empire)



Droit Revers

MO-1001

US 1001

Petit bronze indéterminé

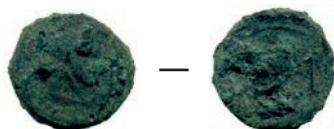


Droit Revers

MO-1004

US 1309 - TP 1170

Petit bronze de Marseille (49 av. - 25 ap. J.-C.)



Droit Revers

MO-1008

US 2066 - SP 2064

Indéterminé



Droit Revers

MO-1003

US 1148 - MR 1067

As du Haut-Empire (Domitien ?)



Droit Revers

MO-1005

US 1313 - FS 1171

As de Trajan (97-117)

EPOQUE MODERNE
(ancien régime)



Droit Revers

MO-1006

« nettoyage » MR 1102

Double tournois de Louis XIII (1642-1643)

EPOQUE CONTEMPORAINE
(troisième République)



Droit Revers

MO-1007

US 2001

10 centimes type « Cérès » (1897)



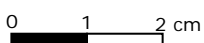
Droit Revers

MO-1002

US 1001

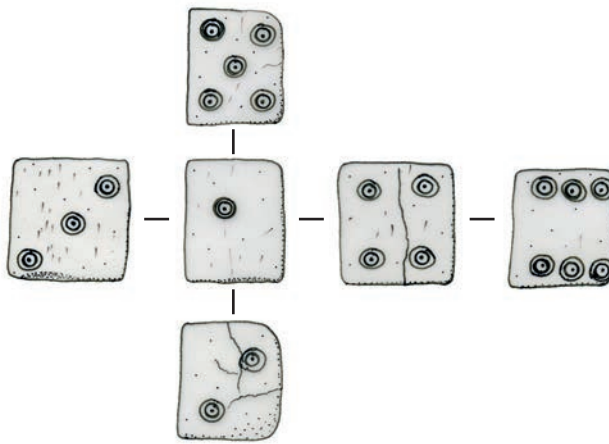
10 centimes type « Lindauer » (1918)

Echelle 1/1





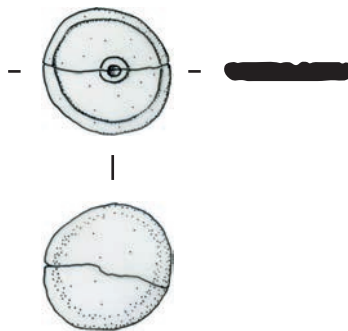
1039.1
FS1002 - US 1039



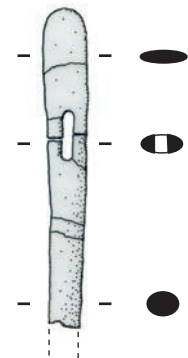
1064.1
US 1064



2066.1
SP2064 - US 2066



2068.1
SP2067 - US 2068

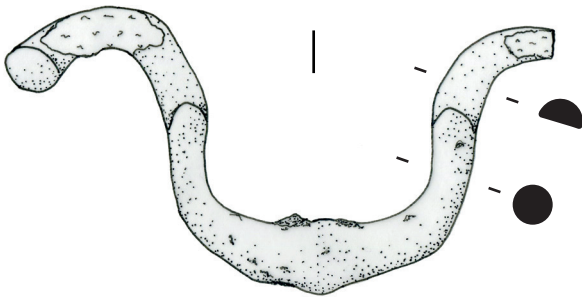
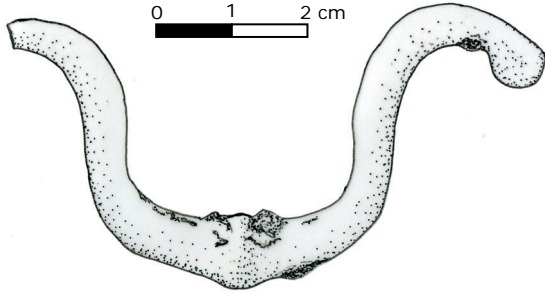


2110.1
SP2105 - US 2110

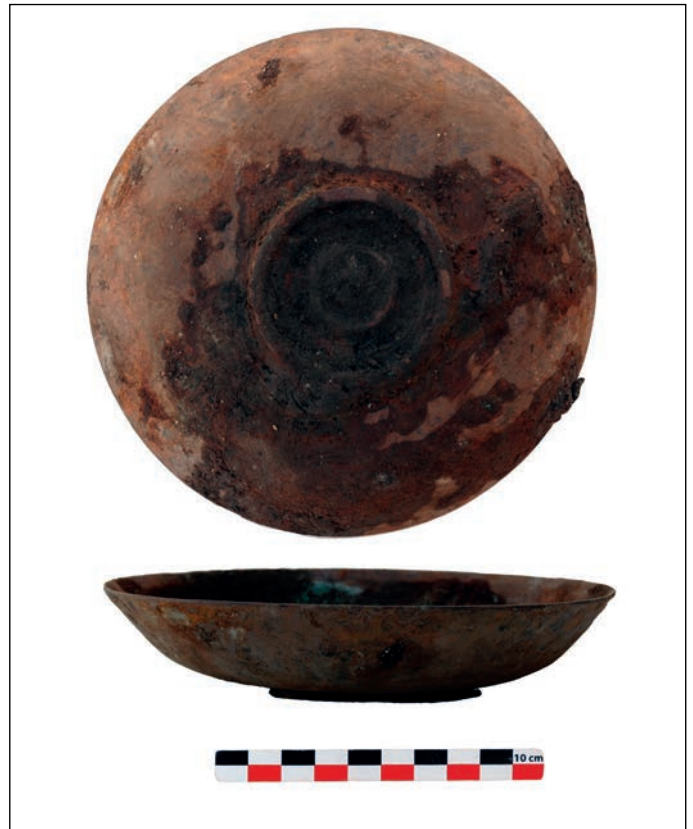
Echelle 1/1
0 1 2 cm

Echelle 1/1

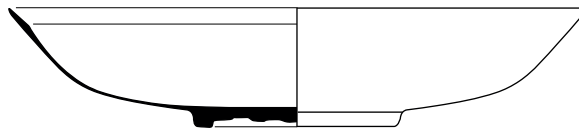
0 1 2 cm



1231.1
PT1149 - US 1231

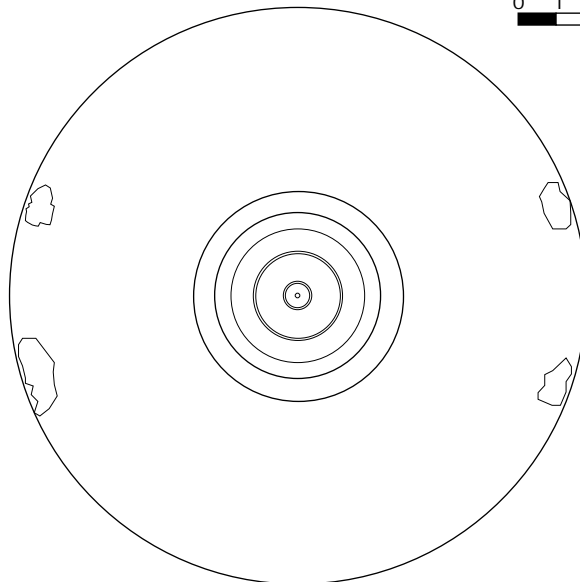


152,5 mm

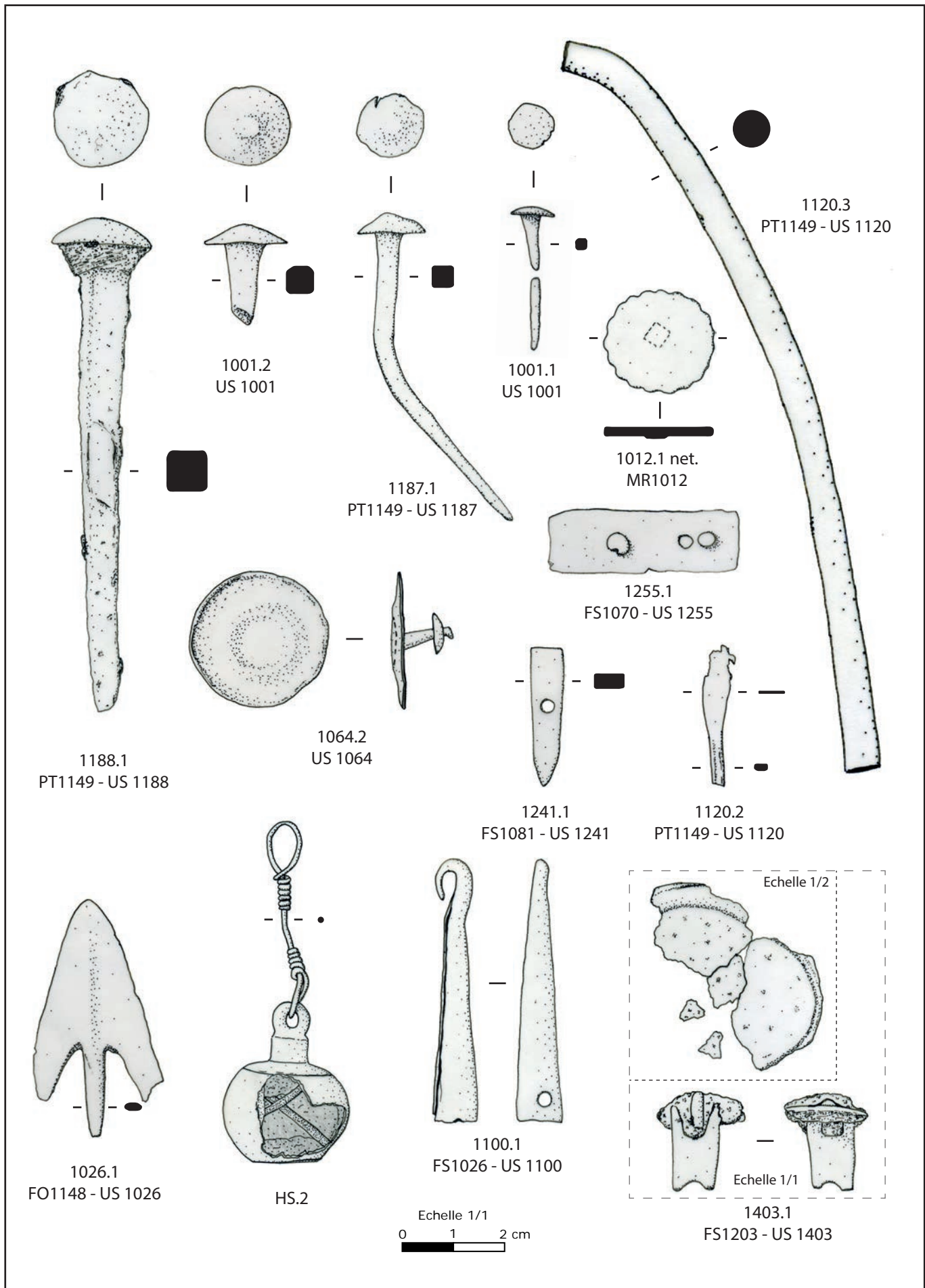


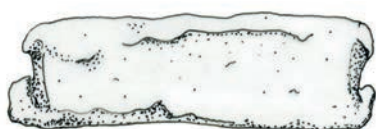
Echelle 1/2

0 1 2 3 4 cm



1231.2
PT1149 - US 1231





|

Echelle 1/1

0 1 2 cm



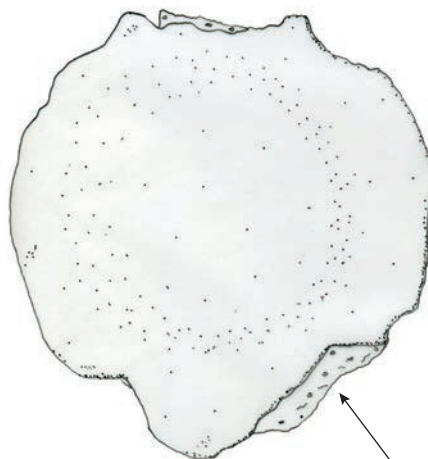
1130.1
CN1113 - US 1130

Céramique
(*dolium*)



Céramique
(*dolium*)

—

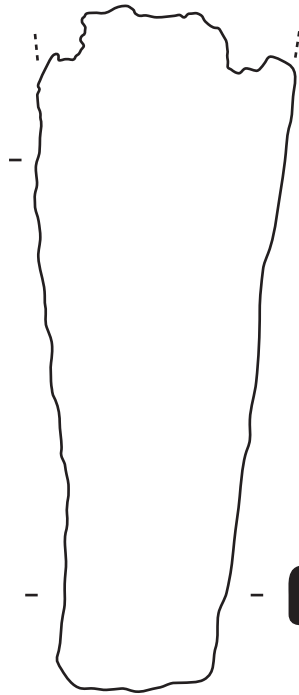


Céramique
(*dolium*)

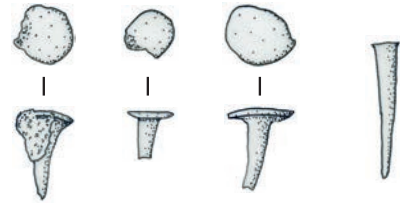
1295.1
FS1165 - US 1295

Echelle 1/2

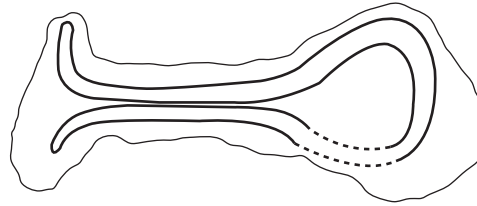
0 1 2 3 4 cm



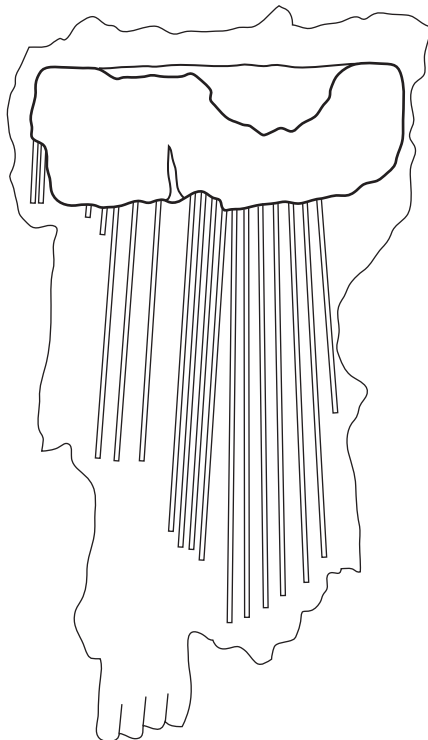
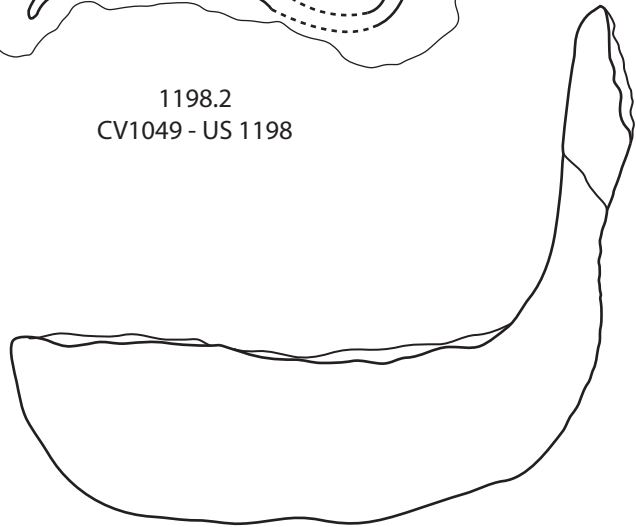
2096.1
SP2019 - US 2096



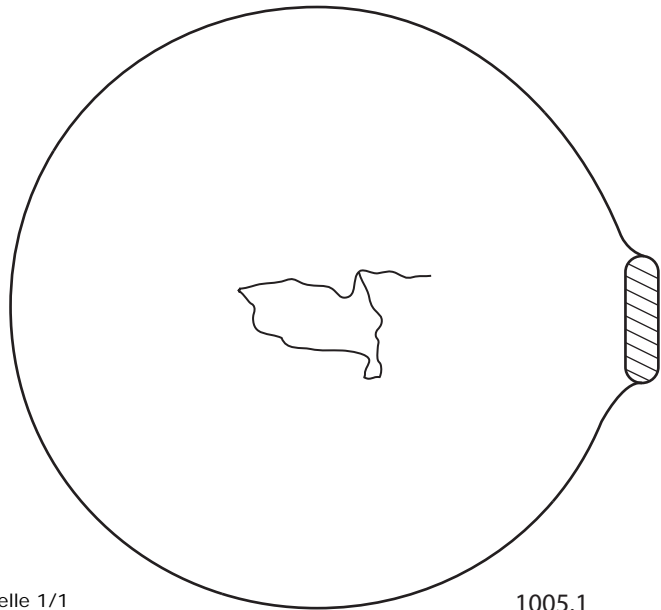
2063.1
SP2010 - US 2063



1198.2
CV1049 - US 1198



1114.1
PO1147 - US 1114



1005.1
FS1126 - US 1005

Echelle 1/1
0 1 2 cm



2001.1
US 2001



1080.1 net
F1080



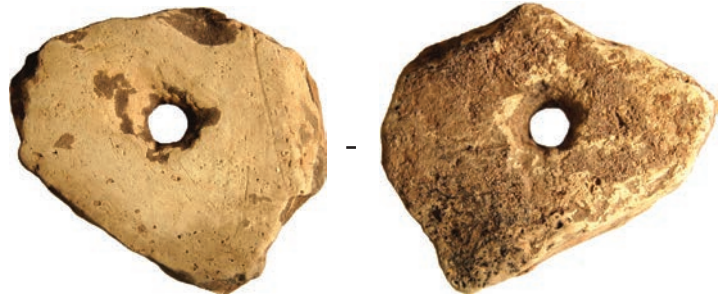
1424.2
FO1213 - US 1424



1001.3
US 1001



1021.1
SL1132 - US 1021



1100.3
FS1026 - US 1100



1114.4
PO1147 - US 1114



1017.4
FO1148 - US 1017



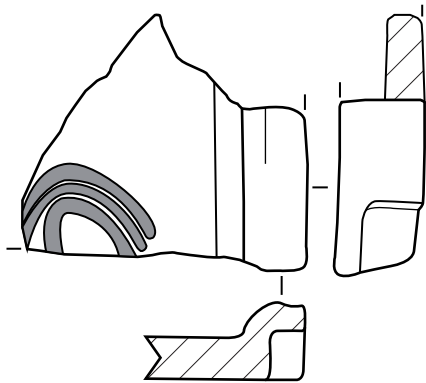
1249.1
FS1068 - US 1249



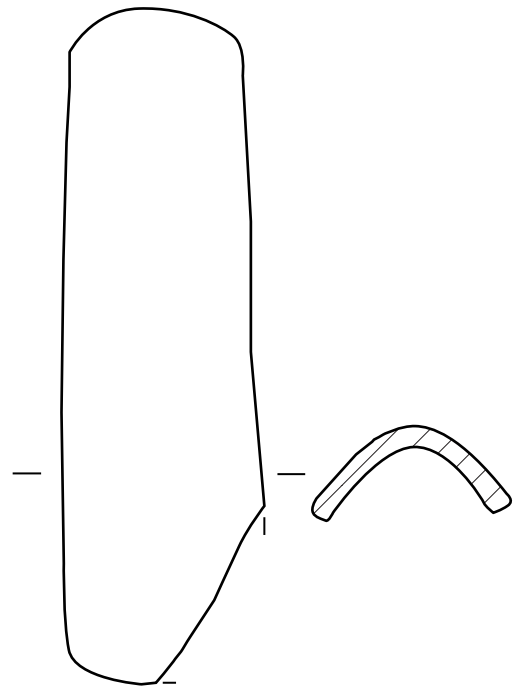
1280.1
CN1162 - US 1280



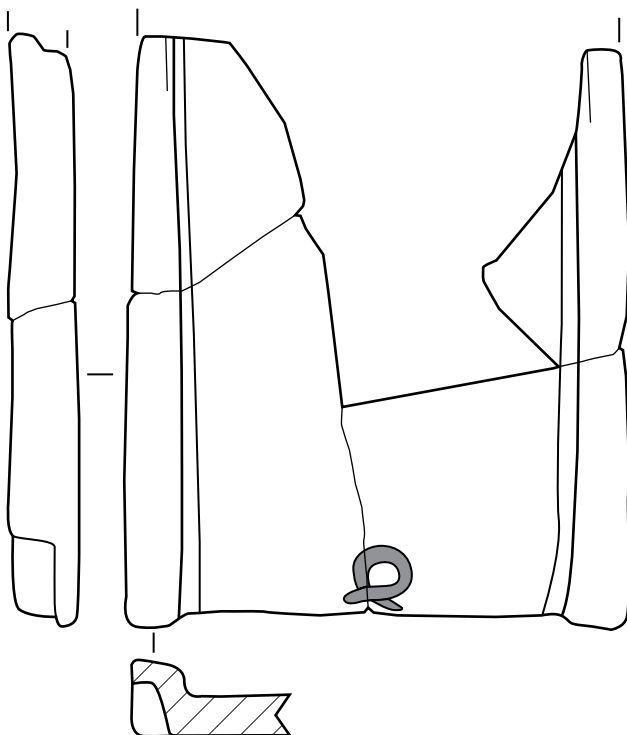
1424.3
FO1213 - US 1424



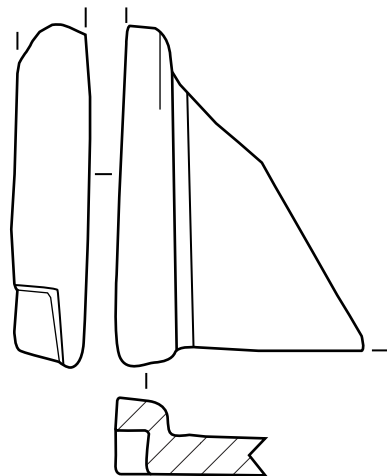
La Farlède 13 - US1188.2



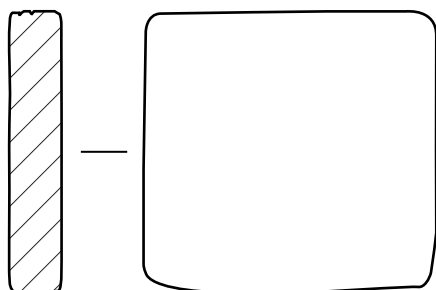
La Farlède 13 - US1188.3



La Farlède 13 - US1266.1

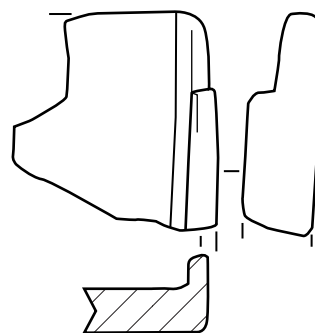


La Farlède 13 - US1291.2-1

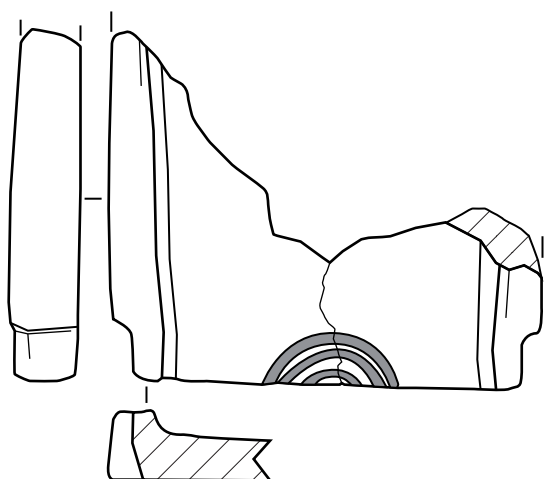


La Farlède 13 - US1289.1

a



La Farlède 13 - US1291.2-2



La Farlède 13 - US1414.1



La Farlède 13 - US1291.1

b



1305A01 (face)



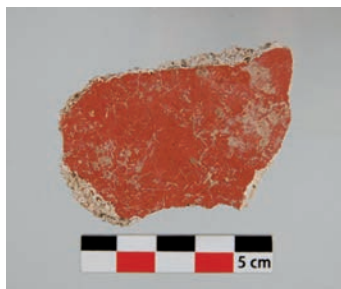
1305A01 (revers)



1305A01 (face)



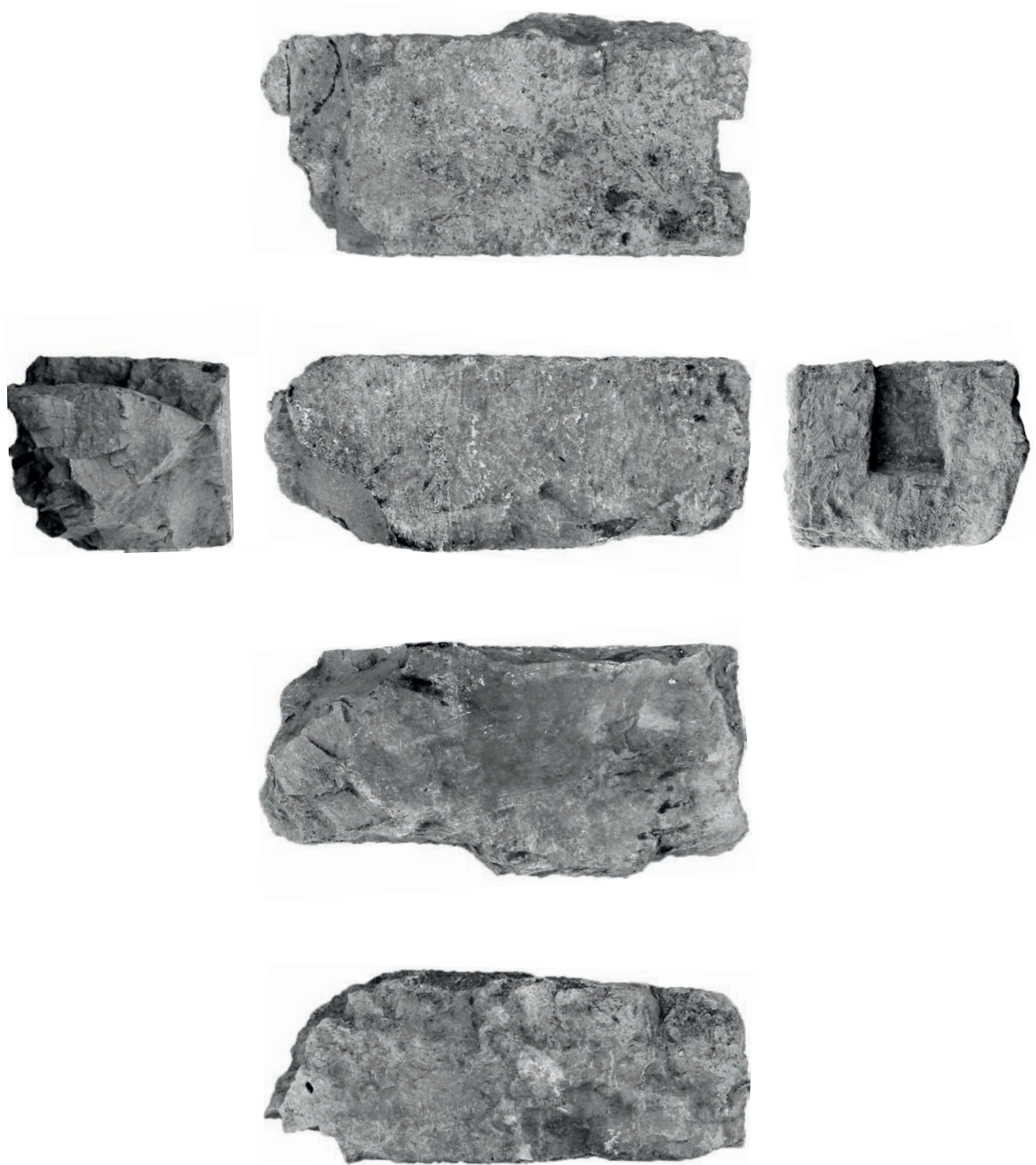
1305A01 (revers)



1015B01



1035B02



0 50 cm

