



HAL
open science

Implementing a quantum memory at microwave frequencies with Bismuth donors in silicon

Audrey Bienfait, Tristan Lorriaux, Yutian Wen, V. Ranjan, Denis Vion, Emmanuel
Flurin, Benjamin Huard, Patrice Bertet

► **To cite this version:**

Audrey Bienfait, Tristan Lorriaux, Yutian Wen, V. Ranjan, Denis Vion, et al.. Implementing a quantum memory at microwave frequencies with Bismuth donors in silicon. *Quantum computing for quantum chemistry*, Nov 2024, Montpellier, France. <hal-04799787>

HAL Id: hal-04799787

<https://hal.science/hal-04799787v1>

Submitted on 29 Nov 2024

HAL is a multi-disciplinary open access archive for the deposit and dissemination of scientific research documents, whether they are published or not. The documents may come from teaching and research institutions in France or abroad, or from public or private research centers.

L'archive ouverte pluridisciplinaire **HAL**, est destinée au dépôt et à la diffusion de documents scientifiques de niveau recherche, publiés ou non, émanant des établissements d'enseignement et de recherche français ou étrangers, des laboratoires publics ou privés.



Distributed under a Creative Commons CC BY-NC 4.0 - Attribution - Non-commercial use - International License

Implementing a quantum memory at microwave frequencies with Bismuth donors in silicon

Tristan Lorriaux & Yutian Wen, V. Ranjan, D. Vion, E. Flurin, B. Huard, P. Bertet, A. Bienfait

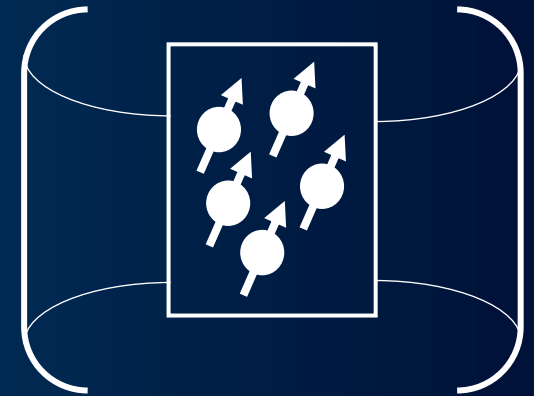
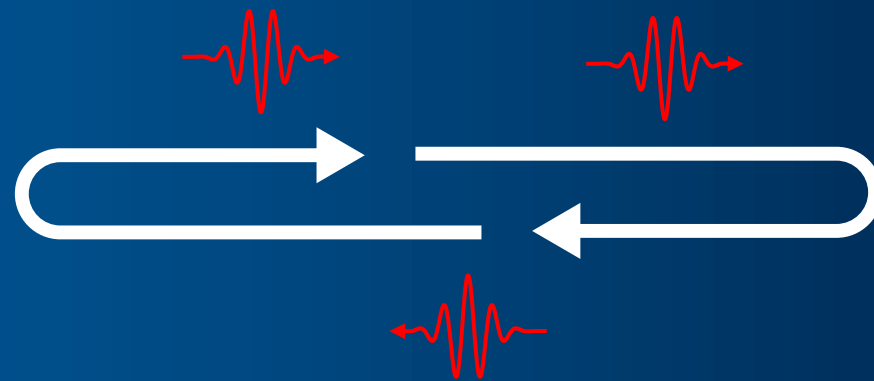
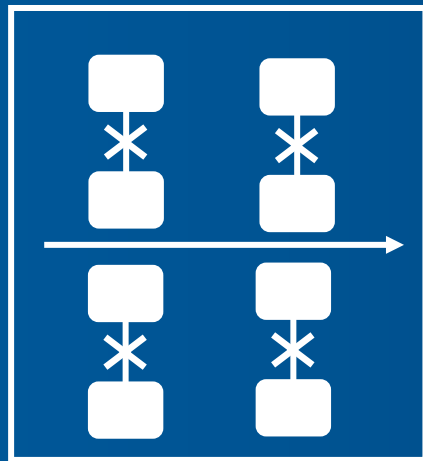

Superconducting circuits: how to implement qubits and gates ?

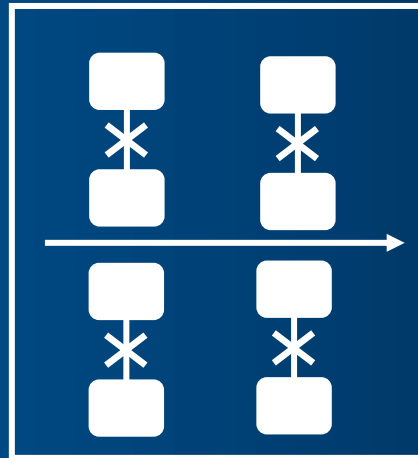

Quantum superconducting circuits

Quantum mechanics
with microwave circuits

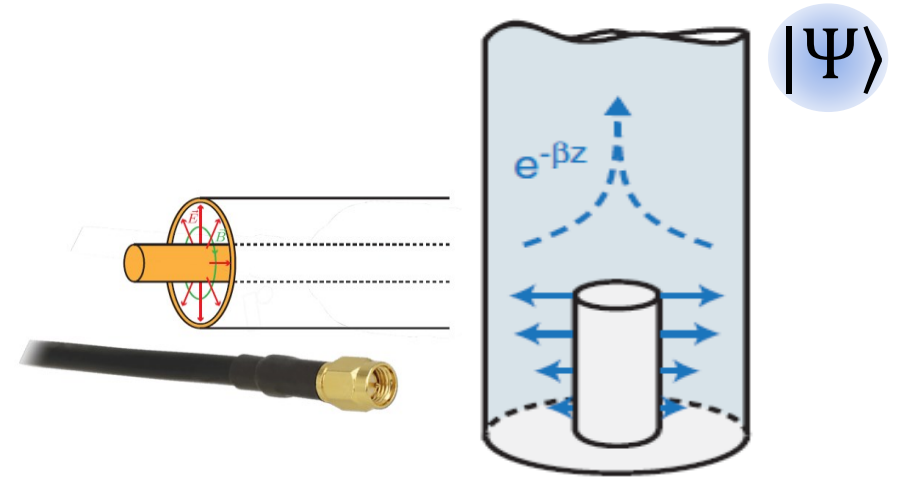

First brick: microwave harmonic oscillator

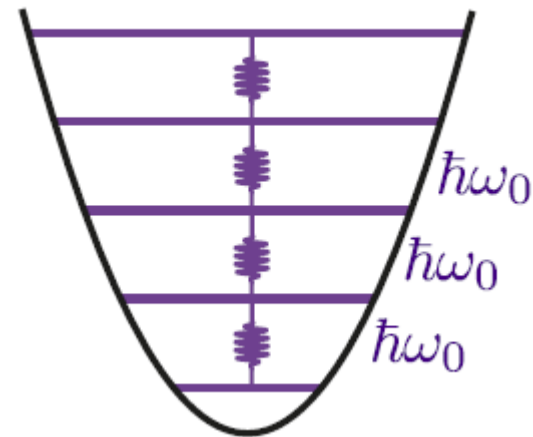
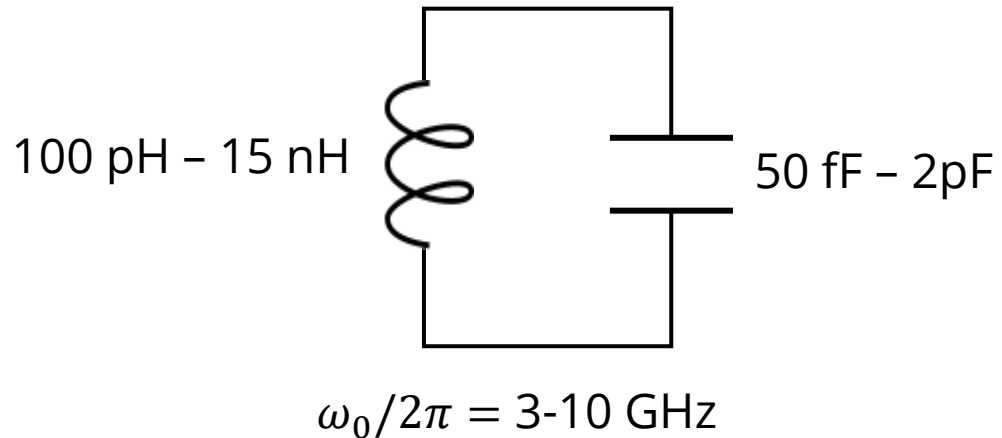

Reaching the quantum regime ?

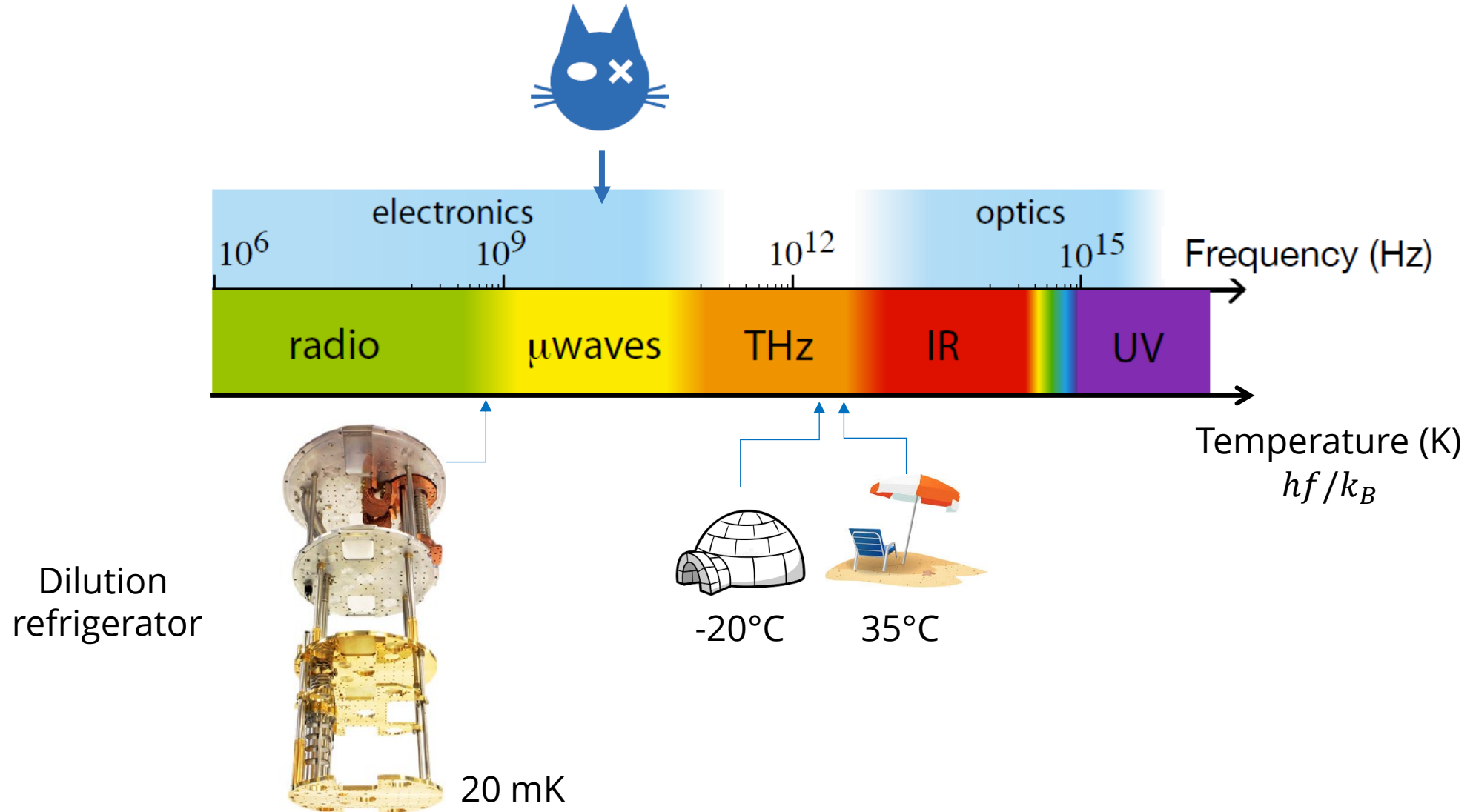

Different flavors of oscillators : bulk type

We need long-lived states

- ⇒ use superconducting materials
- ⇒ low temperature for best quality factor

Aluminum 3D cavity ($T_c = 1\text{K}$)
99.999% purity

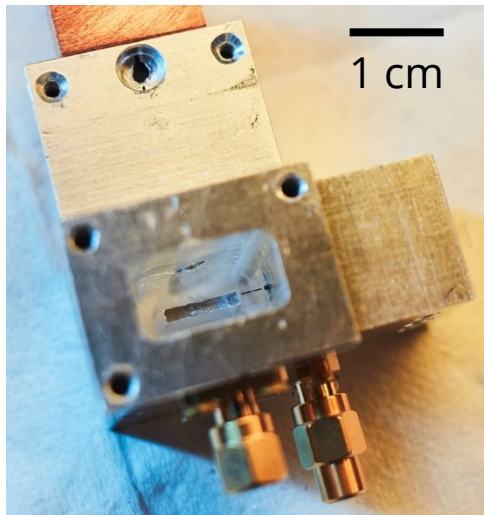

$$T_{\text{decay}} = 1.6 \text{ ms}$$
$$Q = 5 \times 10^7$$

Niobium half elliptical cavity ($T_c = 9.2\text{K}$)

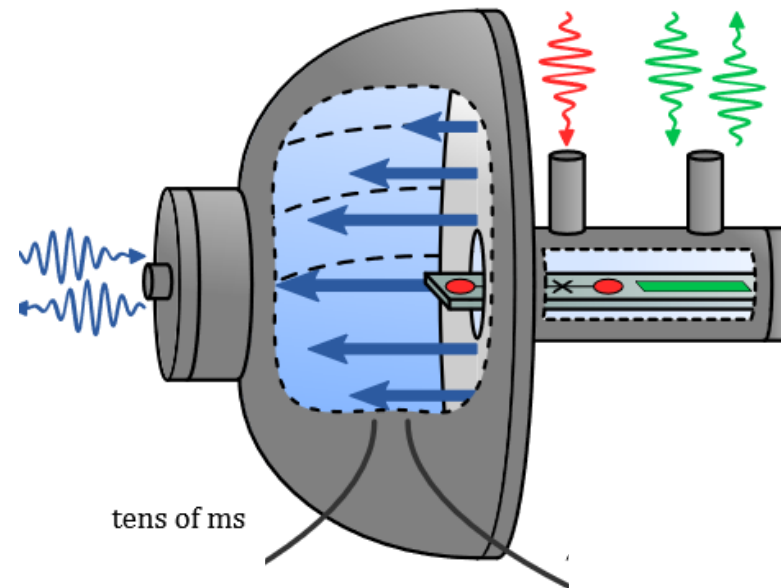

$$T_{\text{decay}} = 25 \text{ ms}$$
$$Q = 1 \times 10^9$$

Different flavors of oscillators : planar type

Tantalum distributed
planar resonators ($T_c = 4.4$ K)

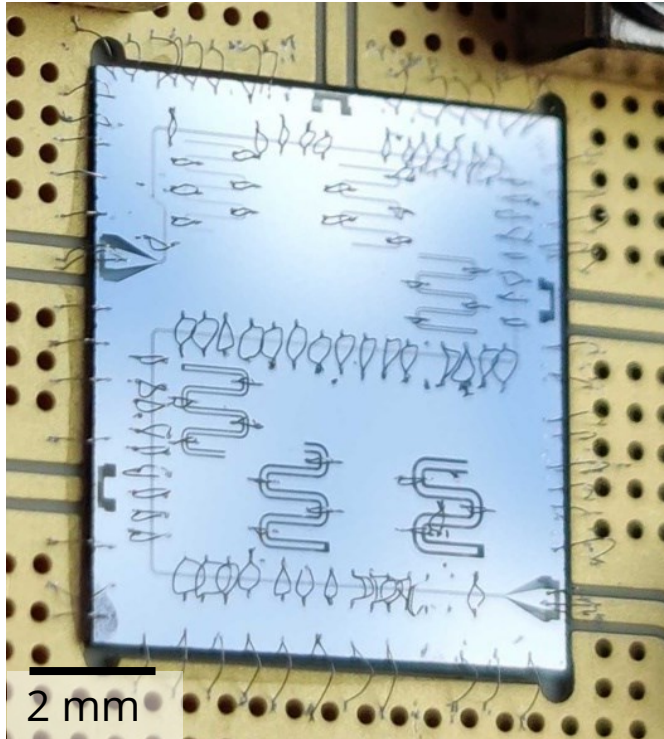

$$\begin{aligned} T_{\text{decay}} &= 19 \mu\text{s} \\ Q &= 1.1 \cdot 10^6 \end{aligned}$$

NbTiN lumped resonators
($T_c = 13$ K, $B_0 = 1$ T)

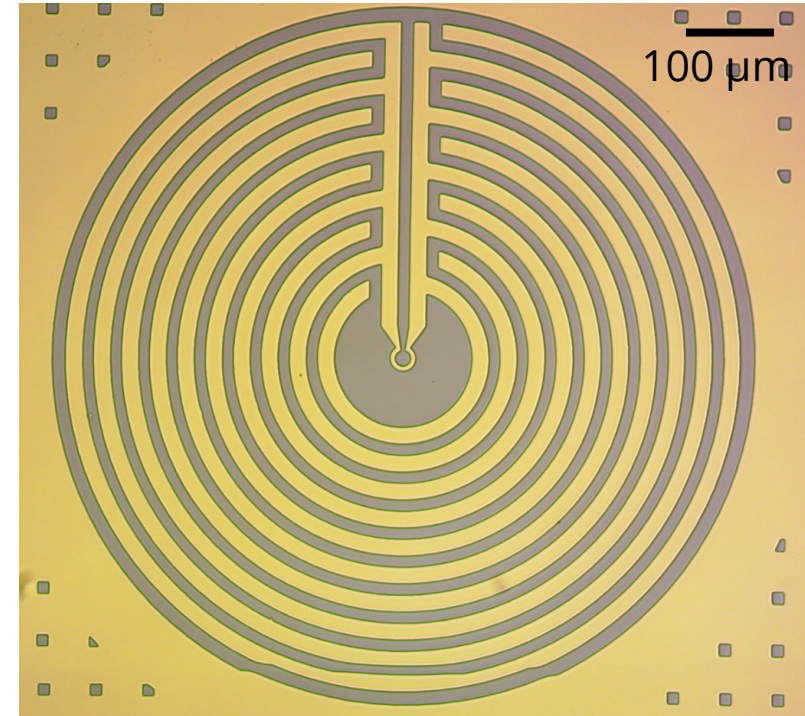

$$\begin{aligned} T_{\text{decay}} &= 16 \mu\text{s} \\ Q &= 6 \cdot 10^5 \end{aligned}$$

Superconducting qubit

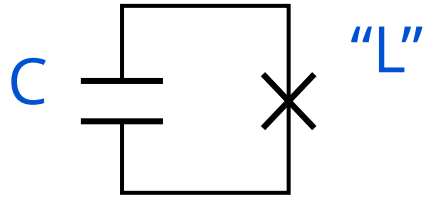
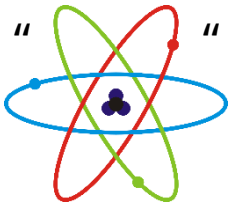

Non-linear LC oscillator

Josephson junction

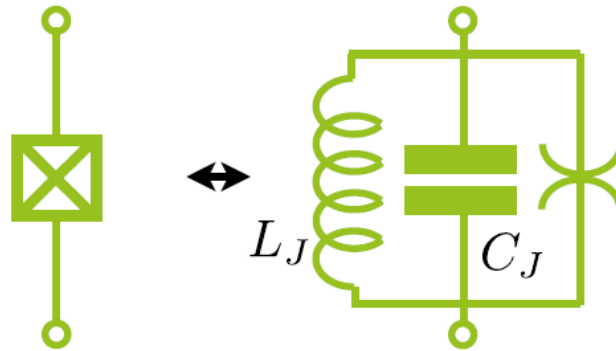
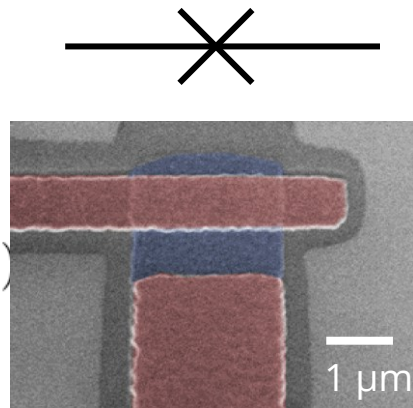
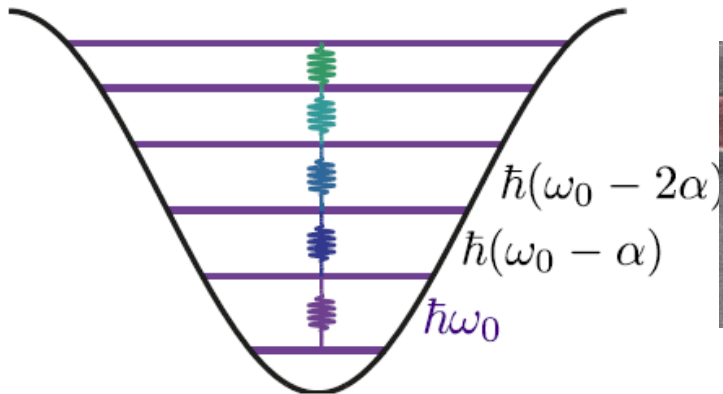

transitions observed in 1980's [Berkeley & Saclay]
strong coupling regime of CQED in 2004 [Yale]

Superconducting qubit

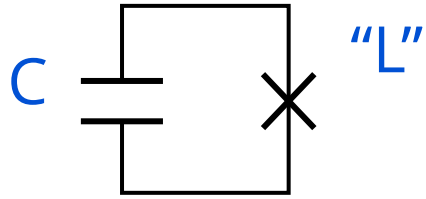
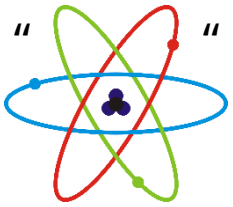

Non-linear LC oscillator

Josephson junction

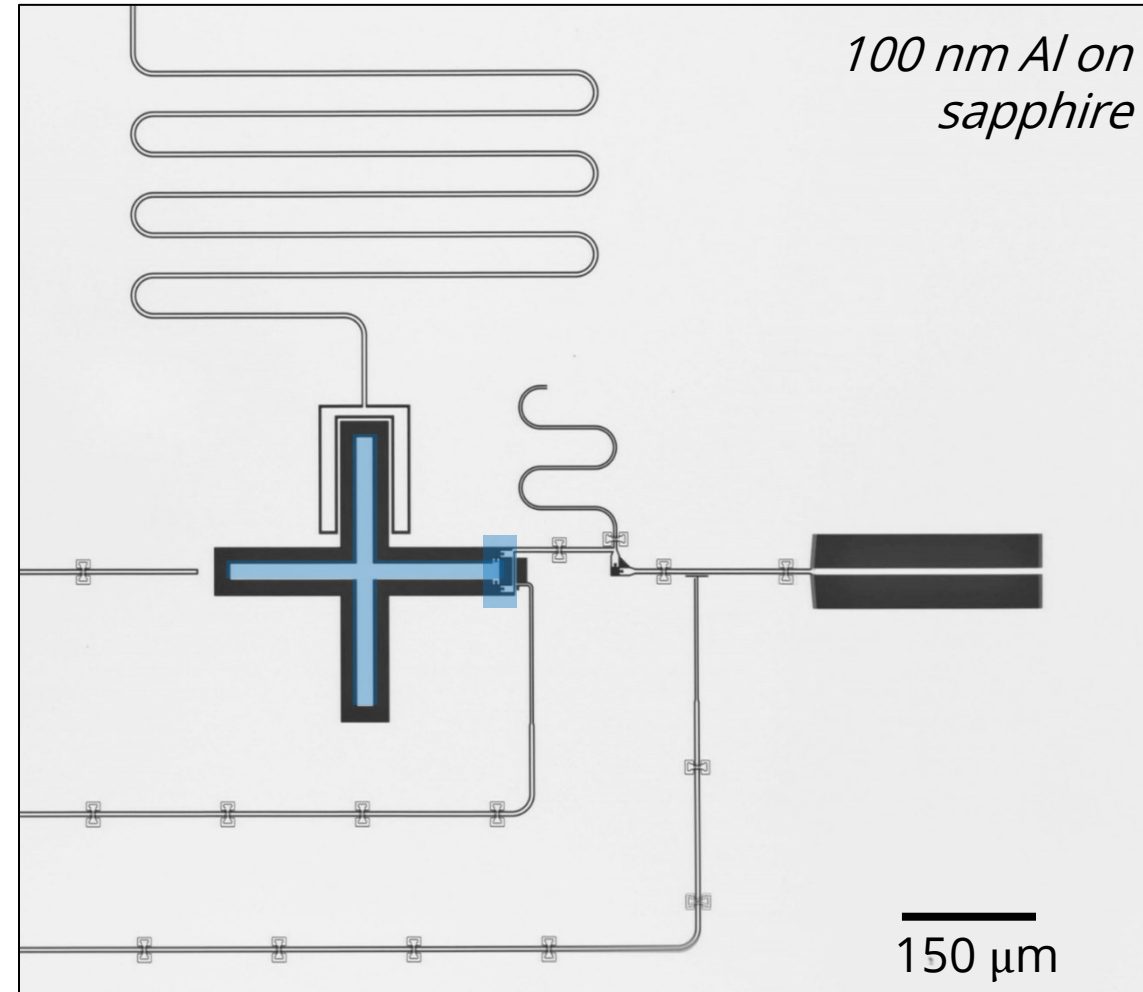
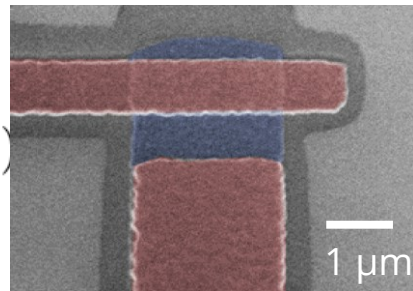
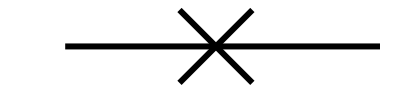
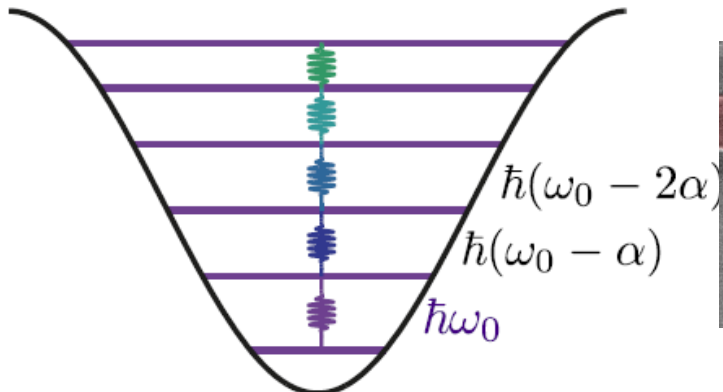

transitions observed in 1980's [Berkeley & Saclay]
 strong coupling regime of CQED in 2004 [Yale]

Superconducting qubit

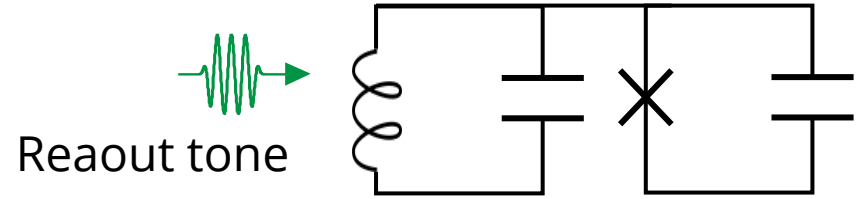

Capacitively coupled to **readout** resonator to measure P_e and P_g .

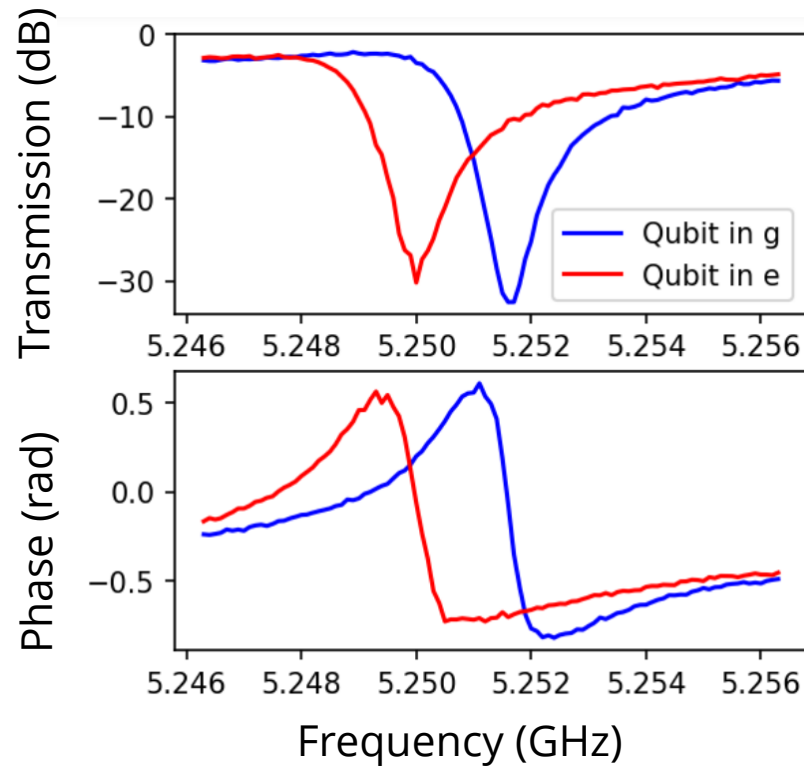
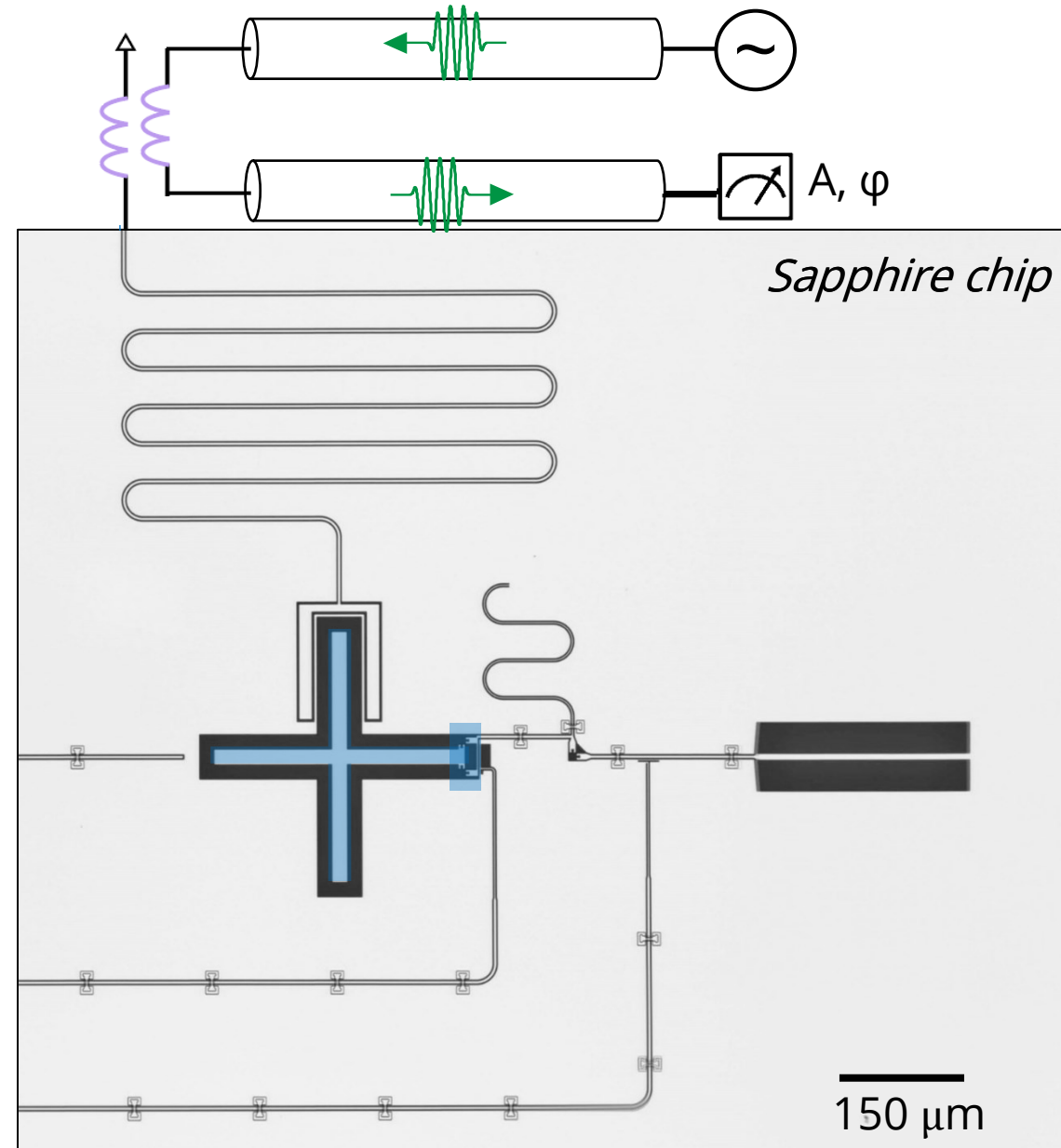

Superconducting qubit: control

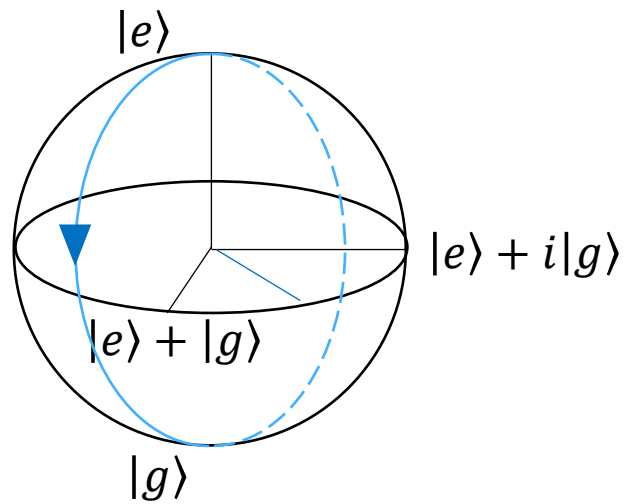
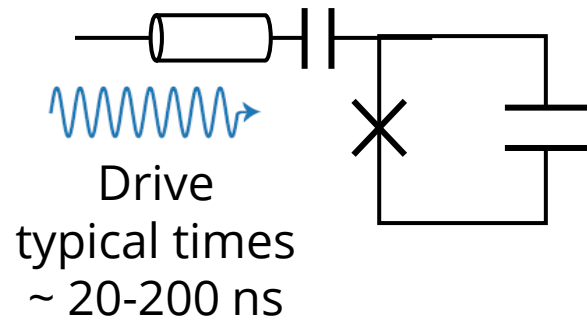

Readout

Excitation and control

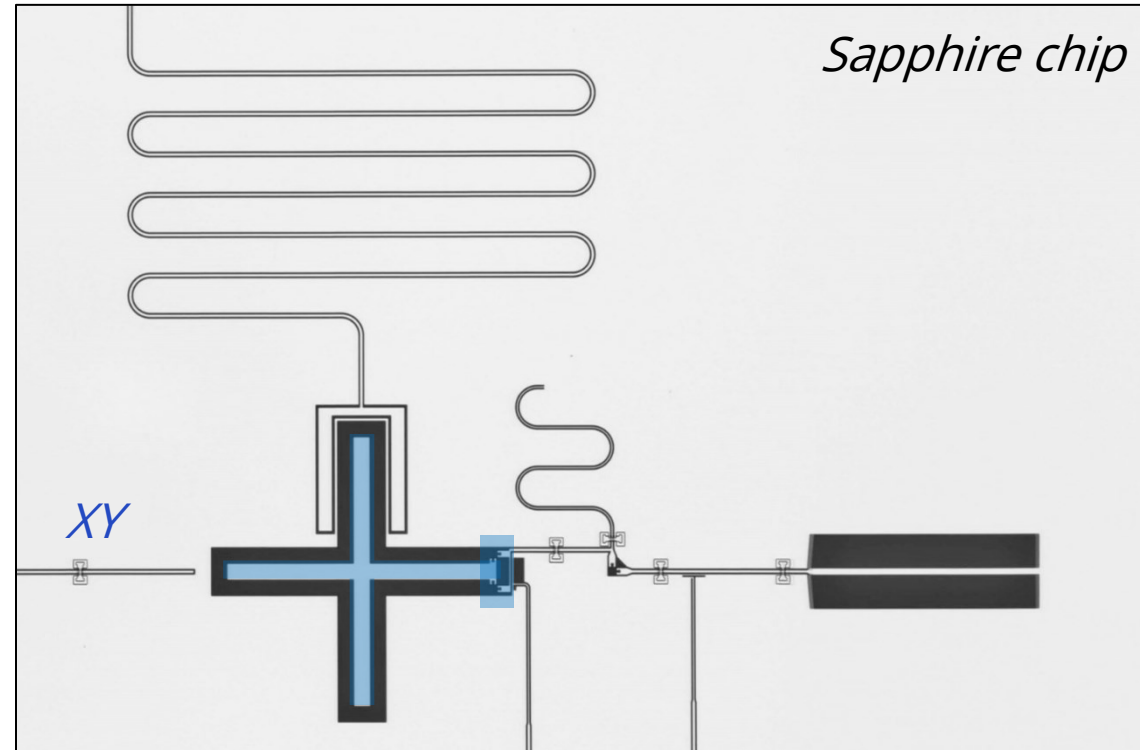

Pauli-X (X)

$$\text{---} \boxed{\text{X}} \text{---} \begin{bmatrix} 0 & 1 \\ 1 & 0 \end{bmatrix}$$

Pauli-Y (Y)

$$\text{---} \boxed{\text{Y}} \text{---} \begin{bmatrix} 0 & -i \\ i & 0 \end{bmatrix}$$

Superconducting qubit: control

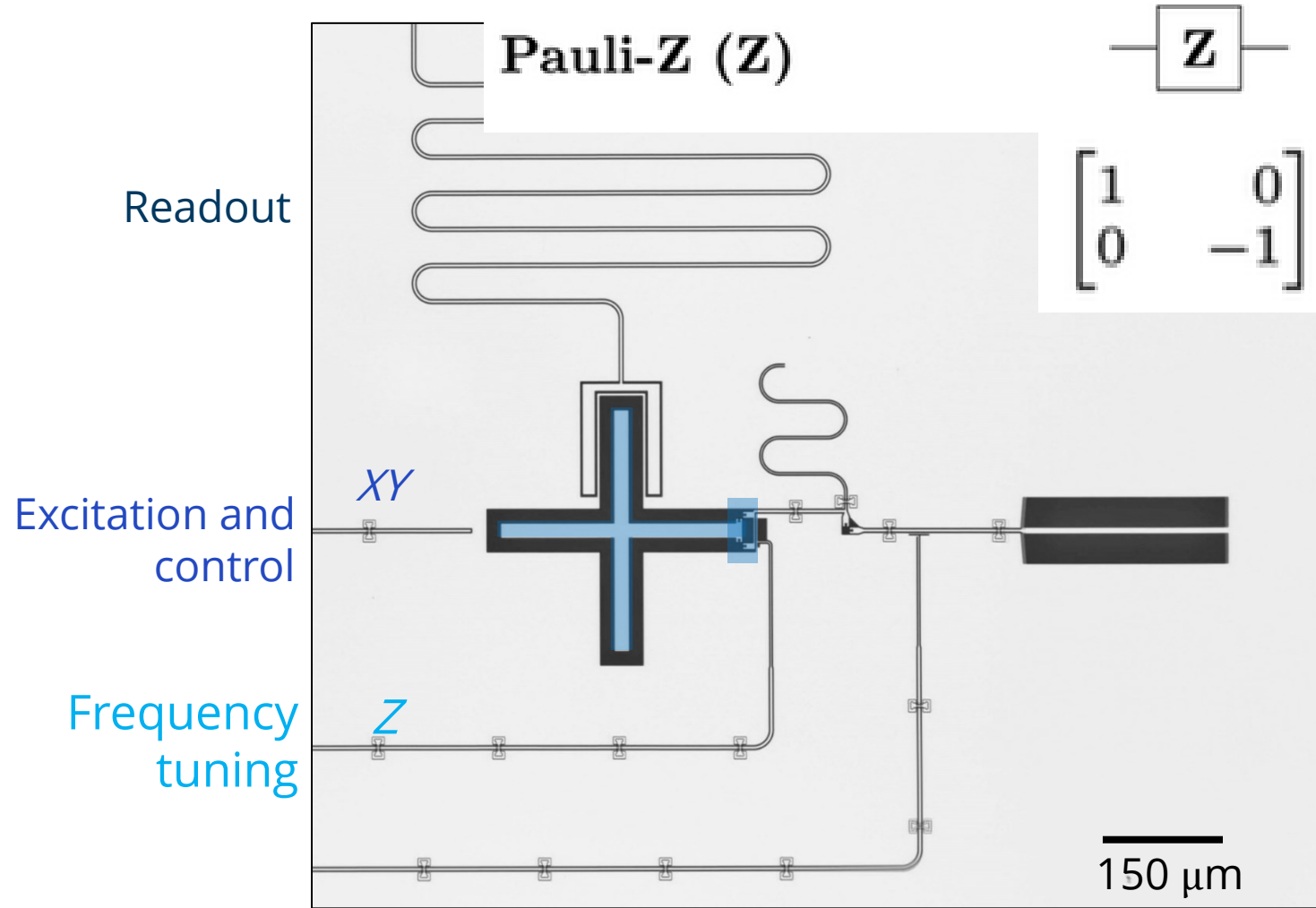
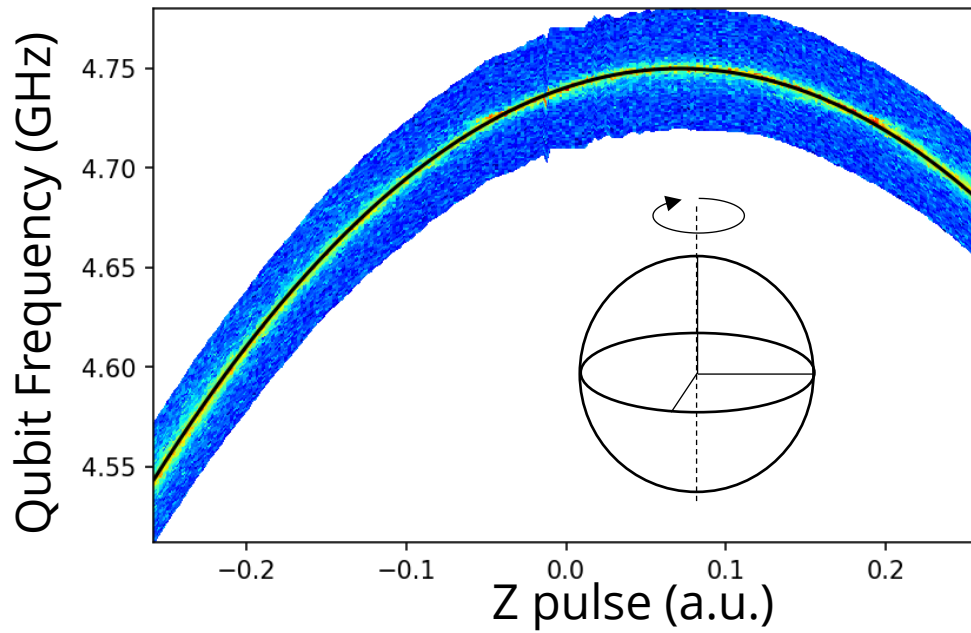
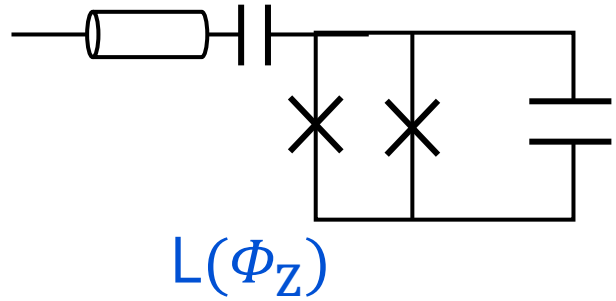

Superconducting qubit: coherence

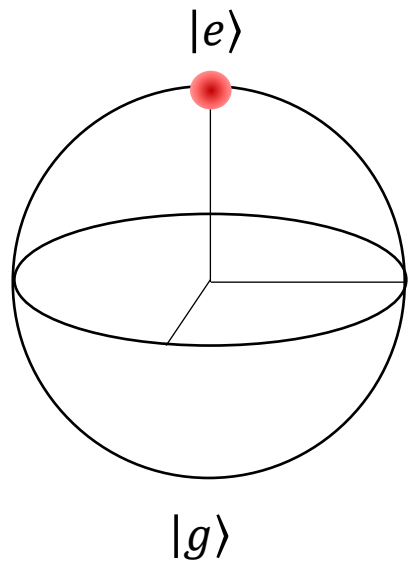

Energy relaxation (T_1)

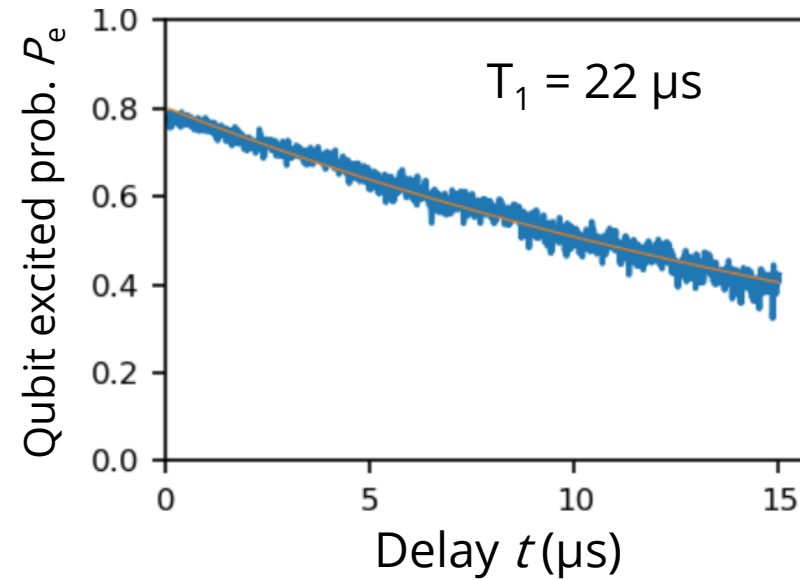
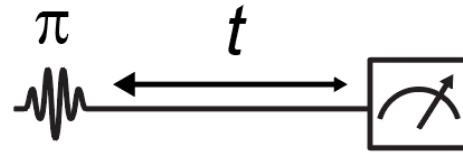

Superconducting qubit: coherence

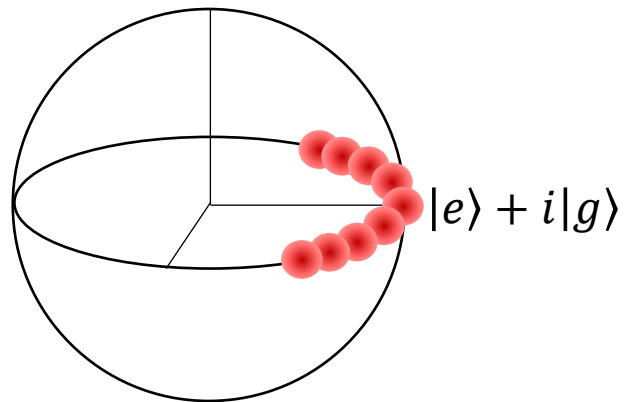

Energy relaxation (T_1)

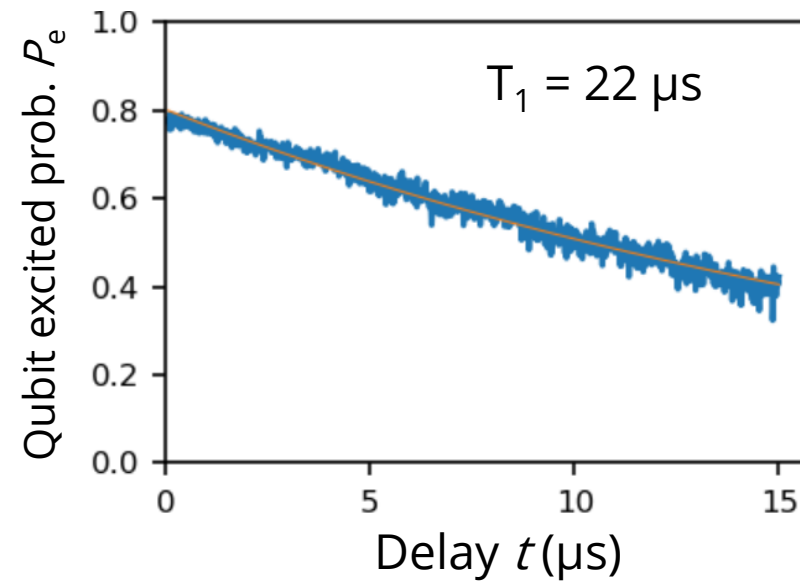
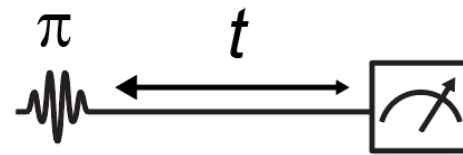

Phase coherence (T_2)

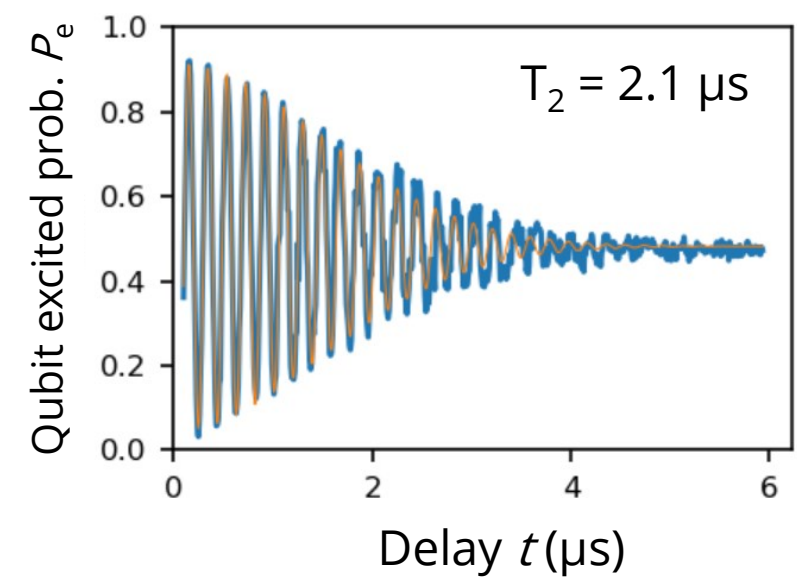
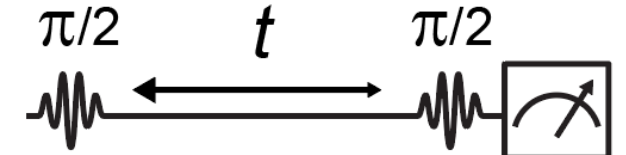

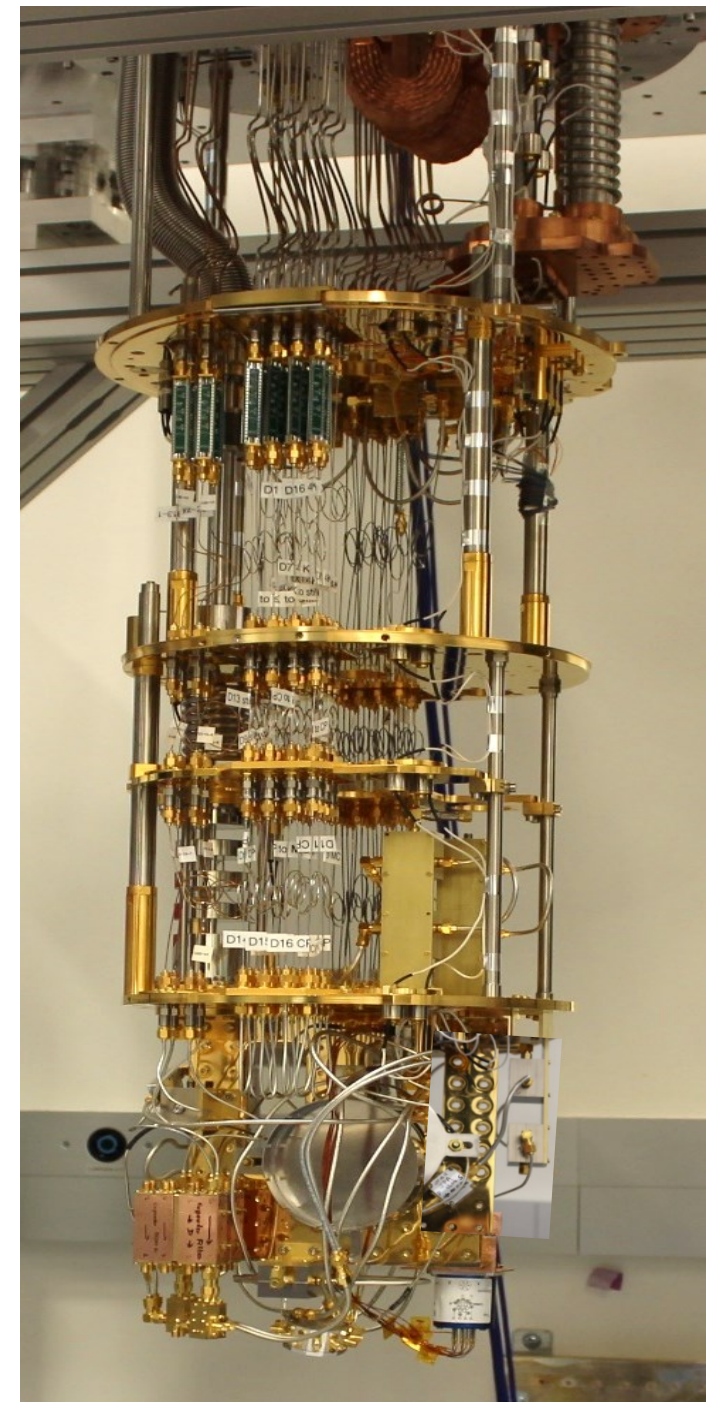
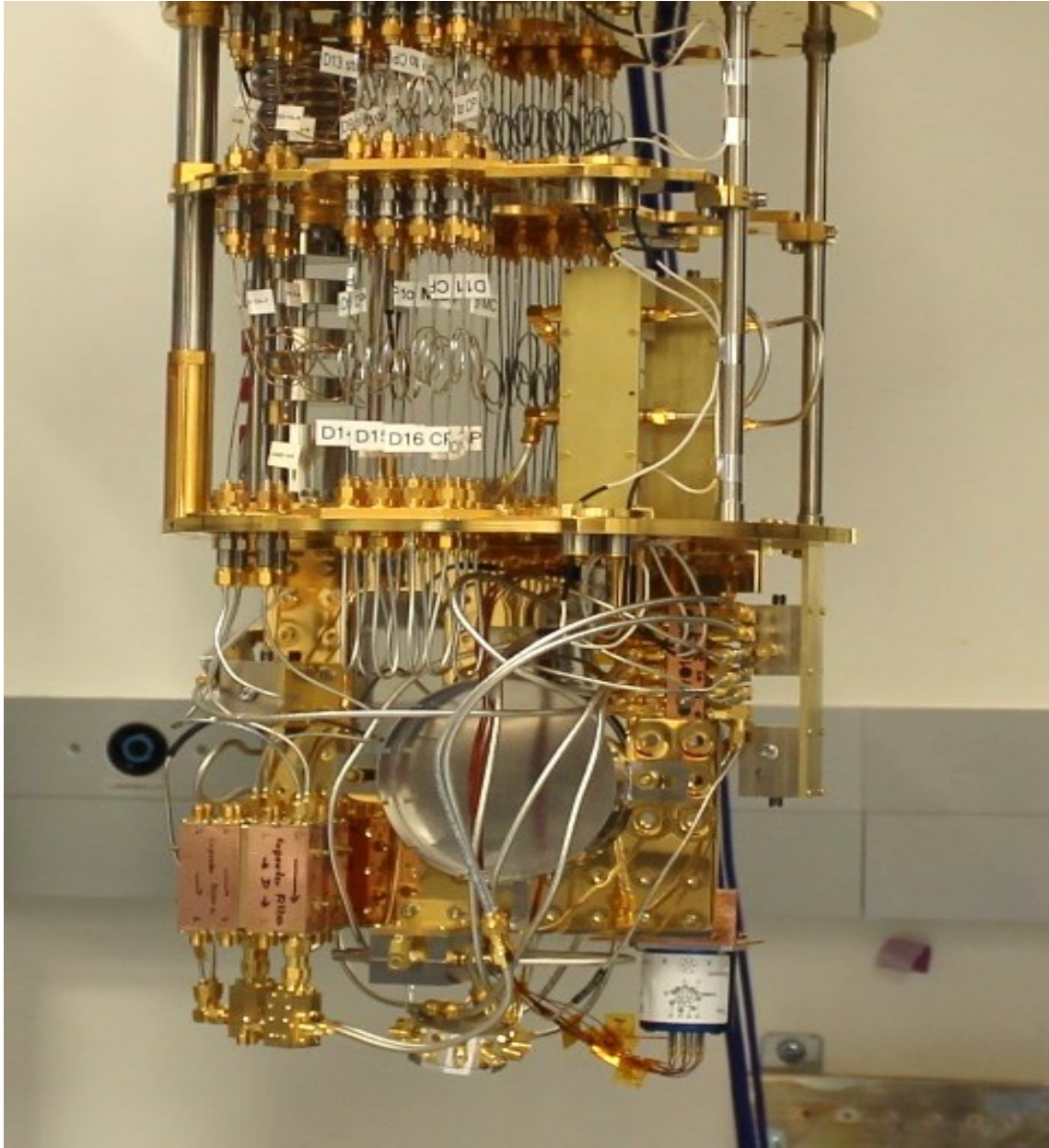

Typical setup

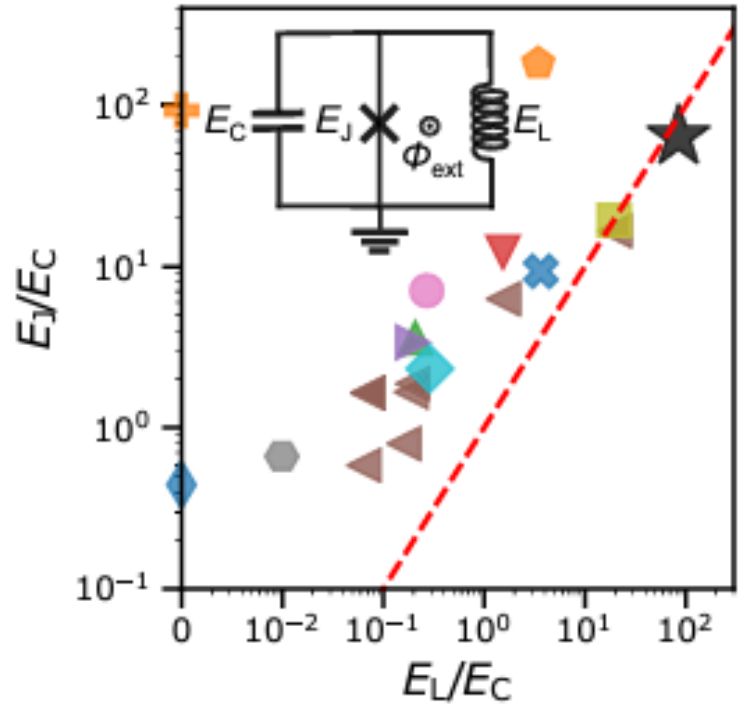

Zoology and lifetimes

 **Transmon**
Popularity



Fluxonium
 Lifetime & gate errors

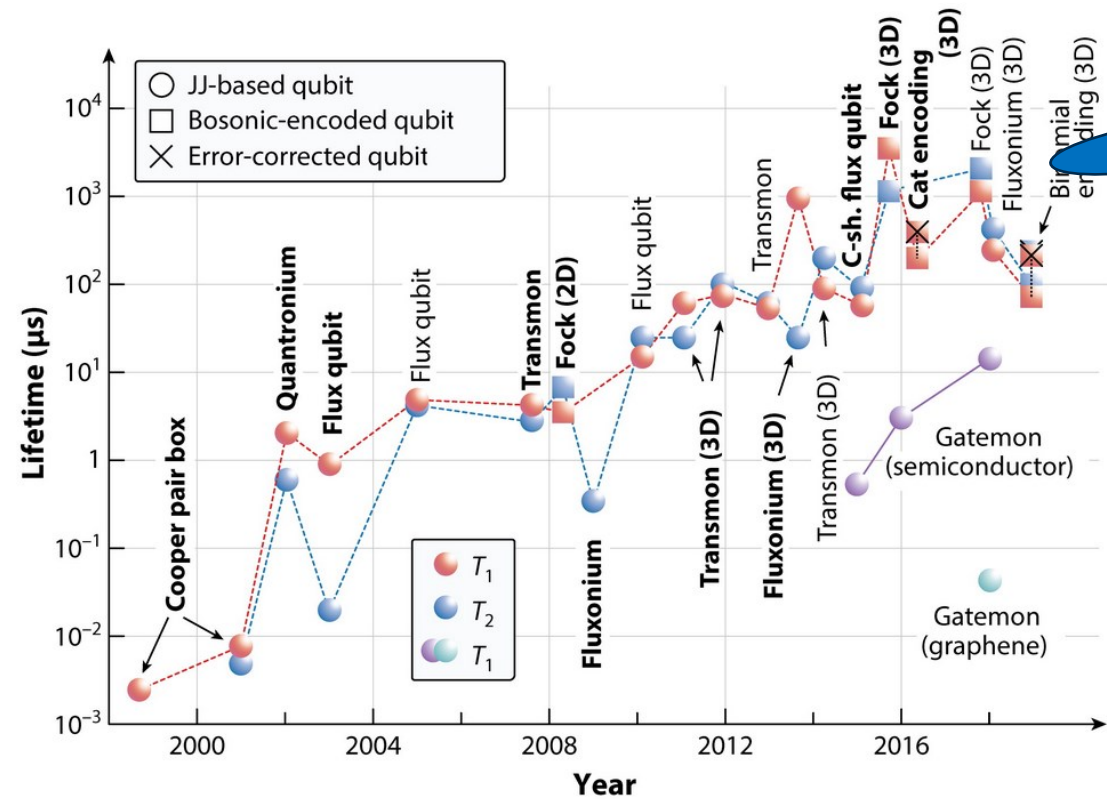

Examples of two qubit gates : SWAP gate

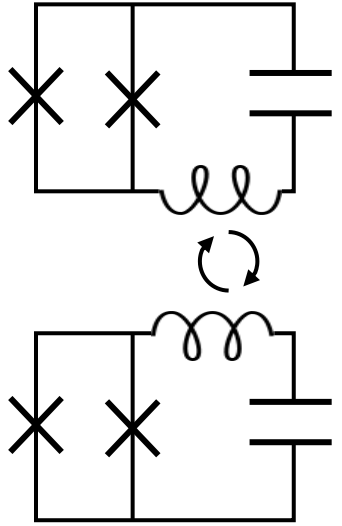

$$H_{\text{int}} = \hbar g (\sigma_+^1 \sigma_-^2 + \sigma_-^1 \sigma_+^2)$$

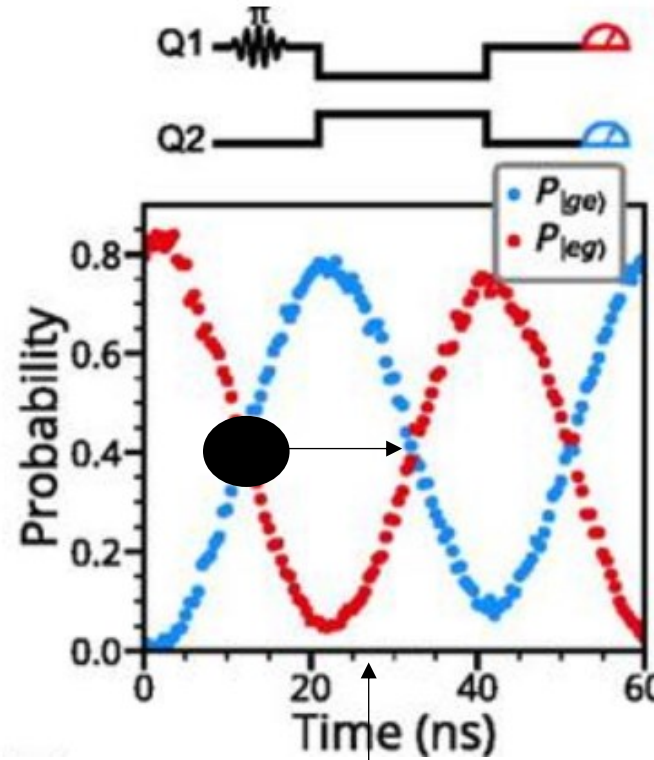
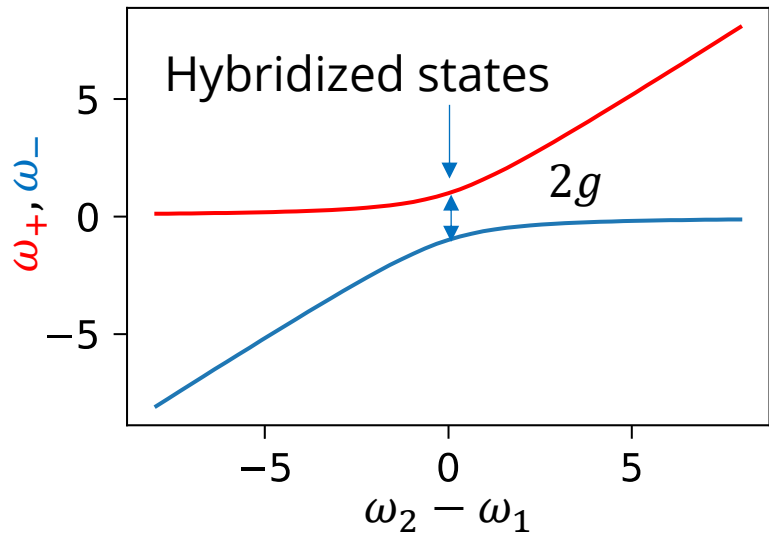

SWAP

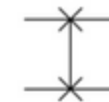

$$\begin{bmatrix} 1 & 0 & 0 & 0 \\ 0 & 0 & 1 & 0 \\ 0 & 1 & 0 & 0 \\ 0 & 0 & 0 & 1 \end{bmatrix}$$

Half swap

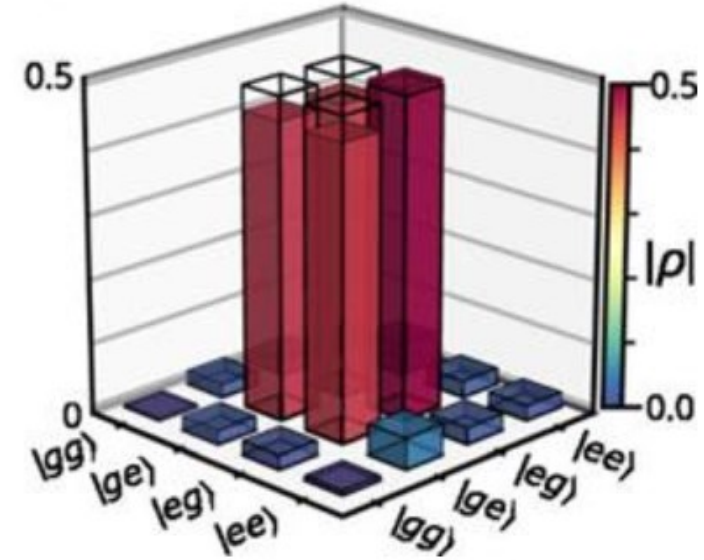

Examples of two qubit gates : CZ gate

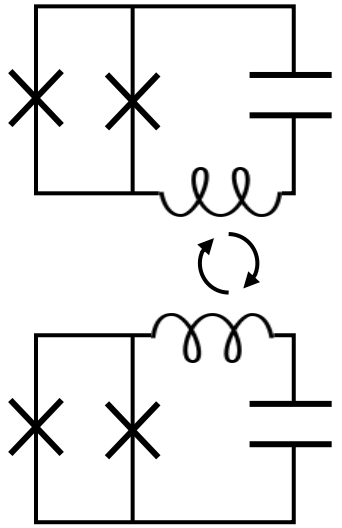

$|gg\rangle \rightarrow |gg\rangle$
 $|ge\rangle \rightarrow |ge\rangle$
 $|eg\rangle \rightarrow |eg\rangle$
 $|ee\rangle \rightarrow |fg\rangle \rightarrow e^{i\phi}|ee\rangle$

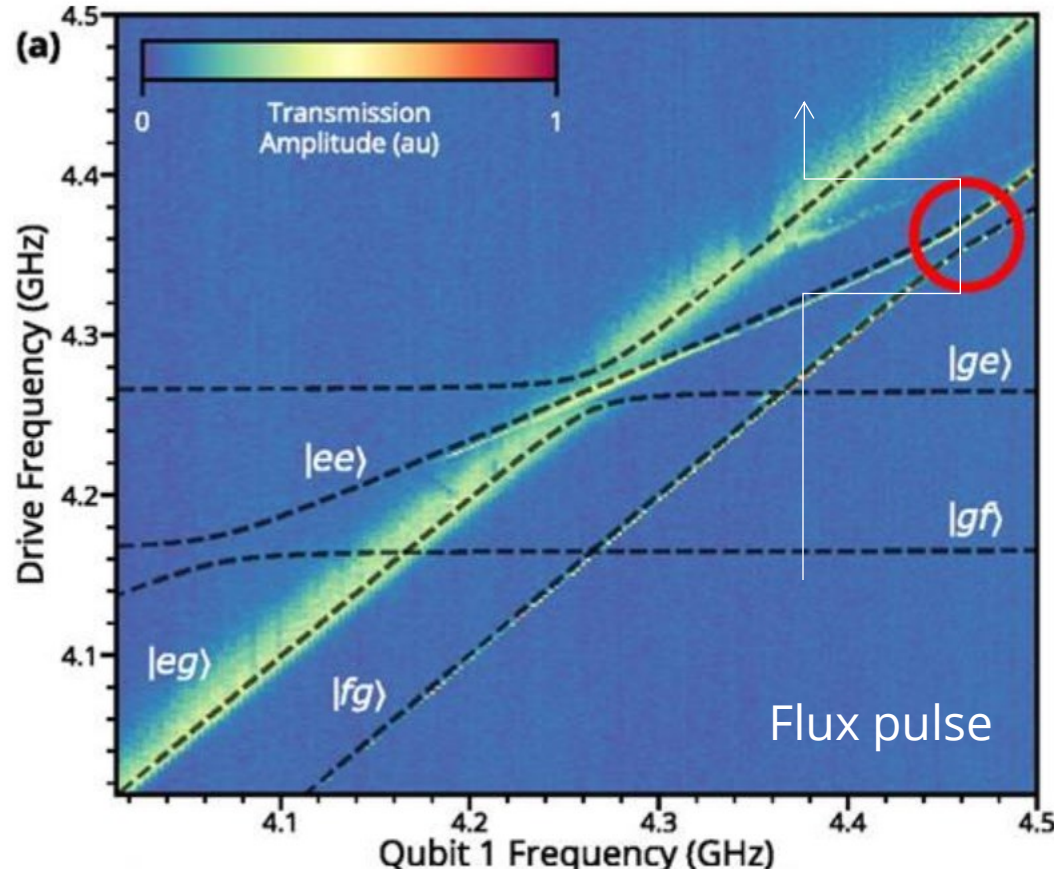

No flux pulse

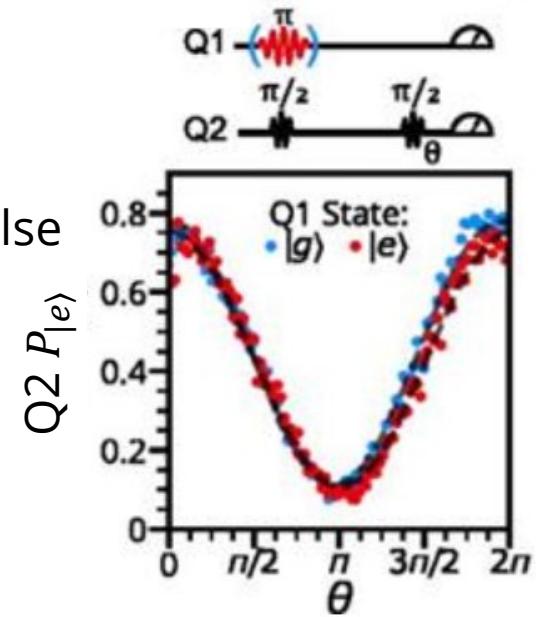

With flux pulse

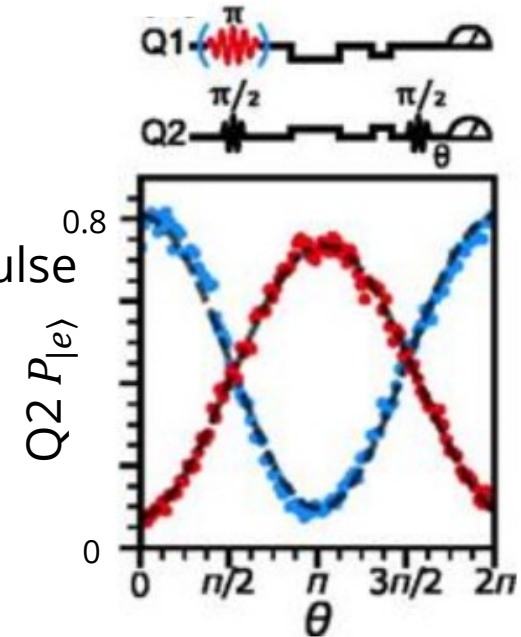

Controlled Z (CZ)



$$\begin{bmatrix} 1 & 0 & 0 & 0 \\ 0 & 1 & 0 & 0 \\ 0 & 0 & 1 & 0 \\ 0 & 0 & 0 & -1 \end{bmatrix}$$

Only hope for viability : quantum error correction

Processor with 105 qubits
≡ 1 logical qubit

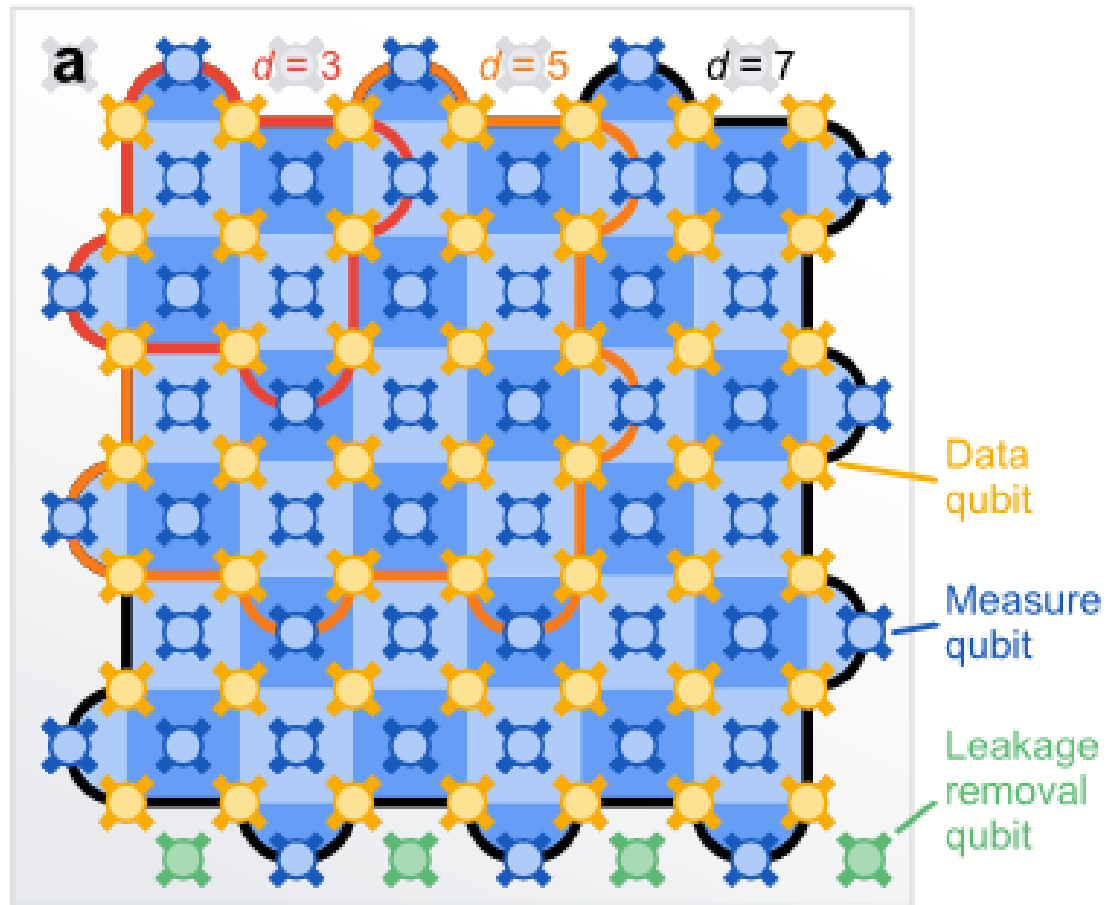

Use stabilizers for error decoding on data qubits

T_1 physical qubit : 89 μs

T_1 logical qubit : 290 μs

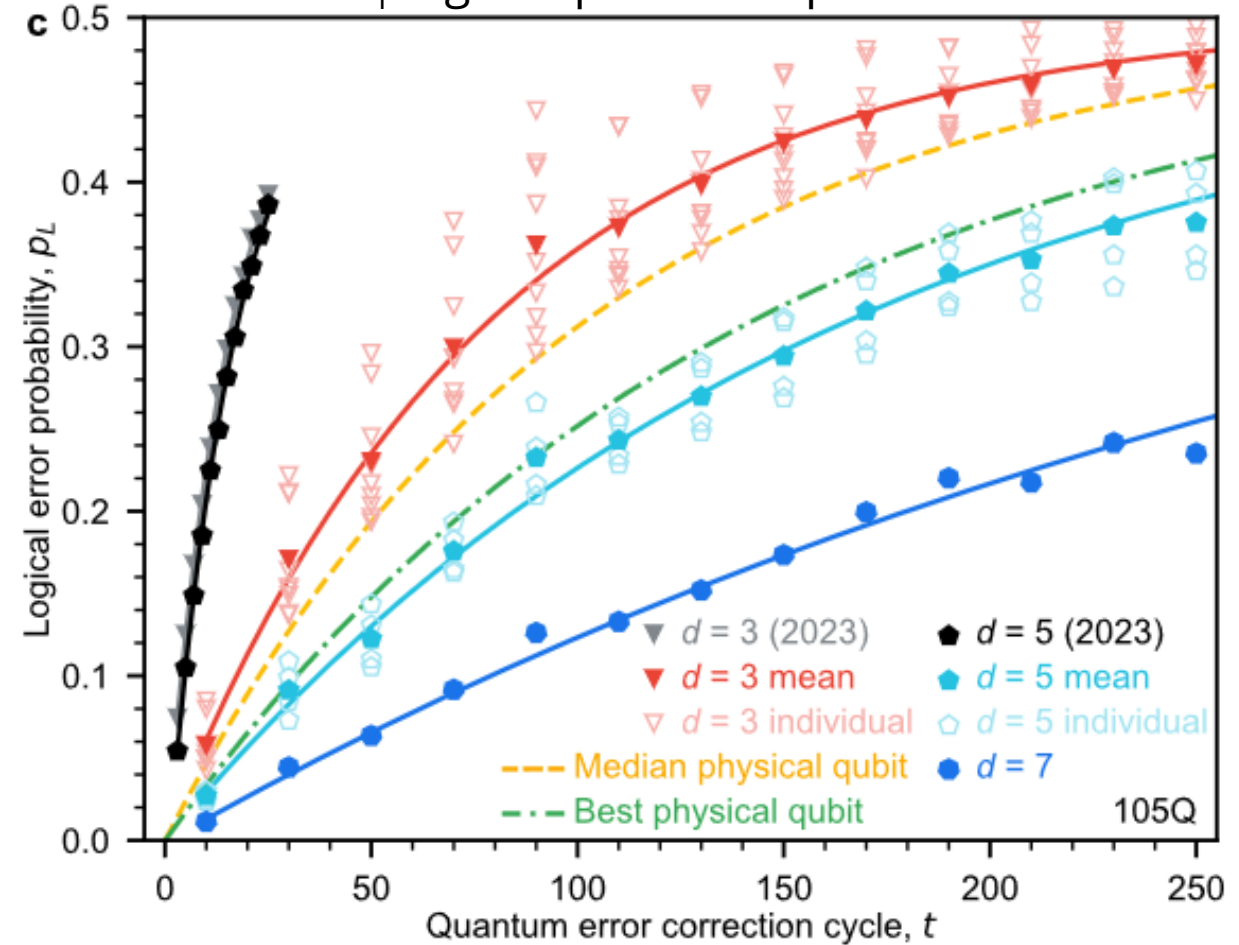

arXiv:2408.13687,
Google Quantum AI

1 cycle = 1.1 μs

Bosonic codes

Redundancy given by usage of multiple Fock states

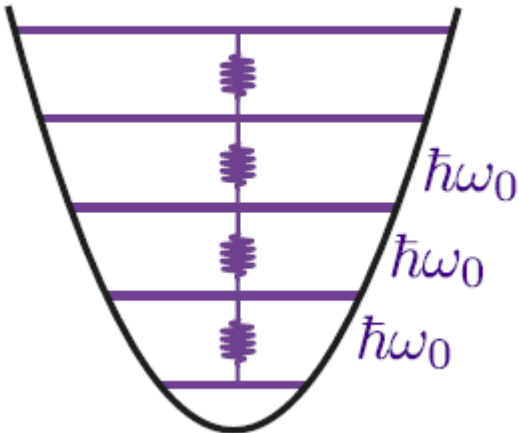

One example of encoding:
 $|0\rangle_L = |\alpha\rangle$
 $|1\rangle_L = |-\alpha\rangle$
 $|+\rangle_L = |\alpha\rangle + |-\alpha\rangle = \sum_i c_i |2i\rangle$
 $|-\rangle_L = |\alpha\rangle - |-\alpha\rangle = \sum_i c_i |2i + 1\rangle$

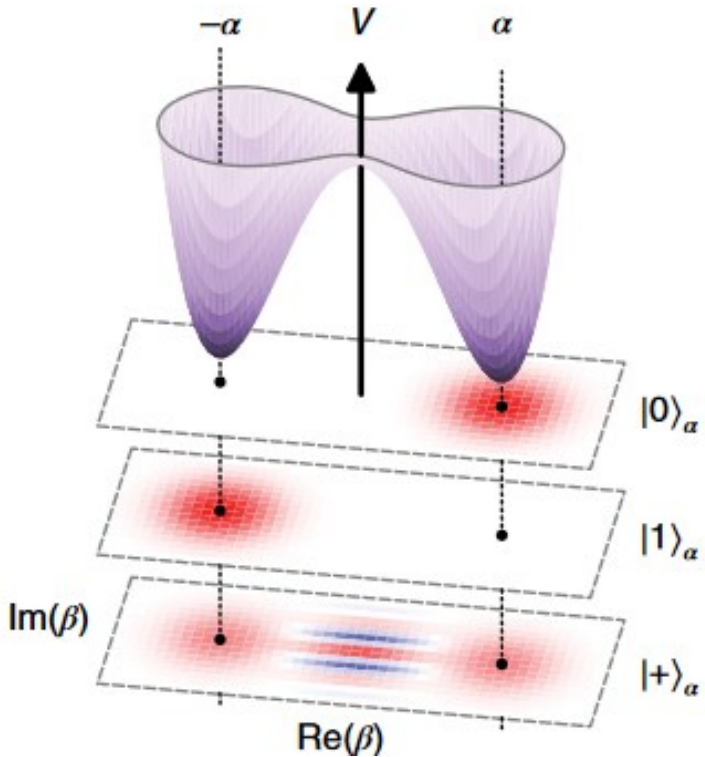
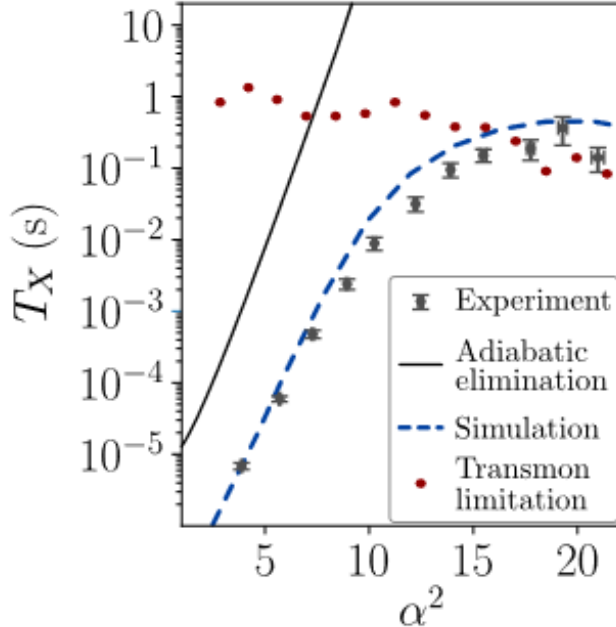
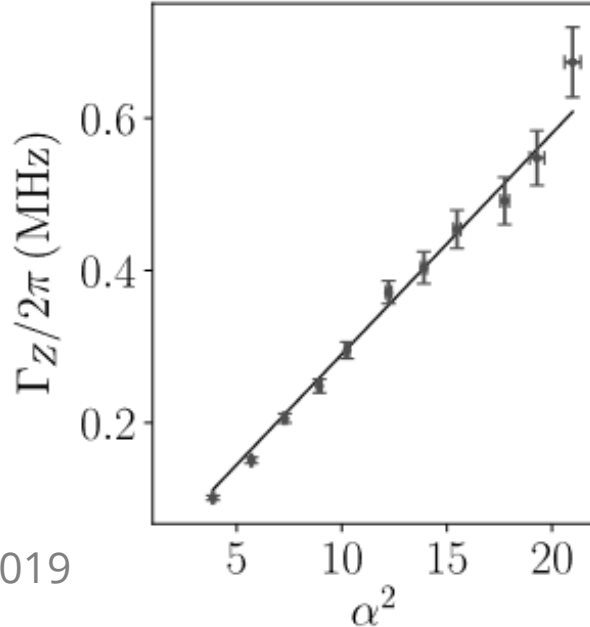
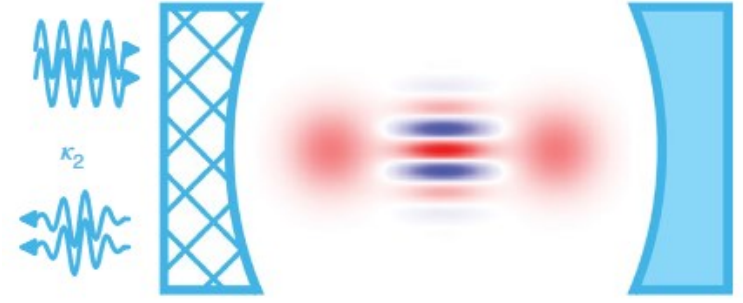

Implementing a quantum memory at microwave frequencies with Bismuth donors in silicon

Tristan Lorriaux & Yutian Wen, V. Ranjan, D. Vion, E. Flurin, B. Huard, P. Bertet, A. Bienfait

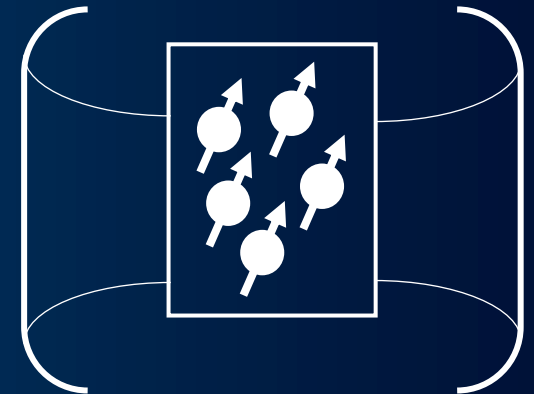
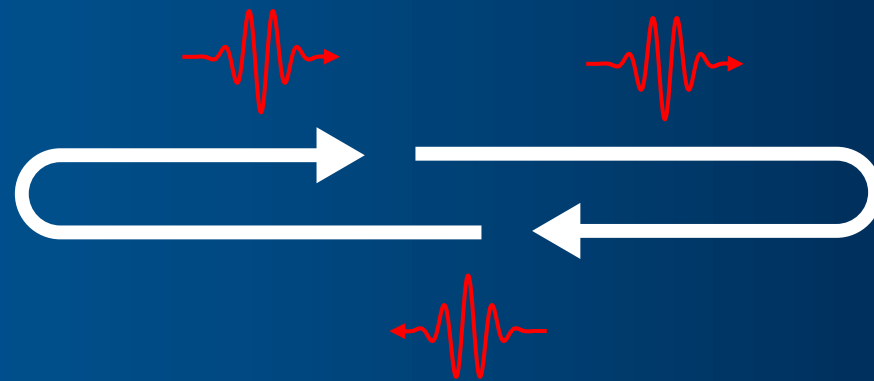
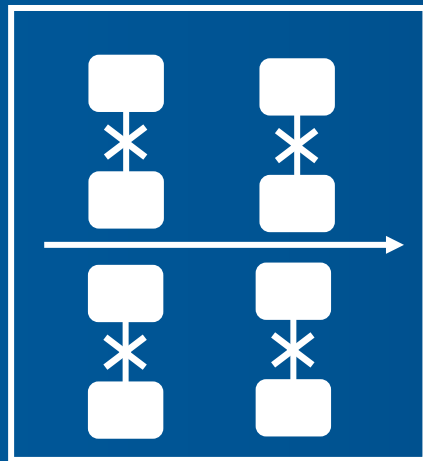

Storing qubits' quantum states

Reduce the number of processing qubits in a quantum computer

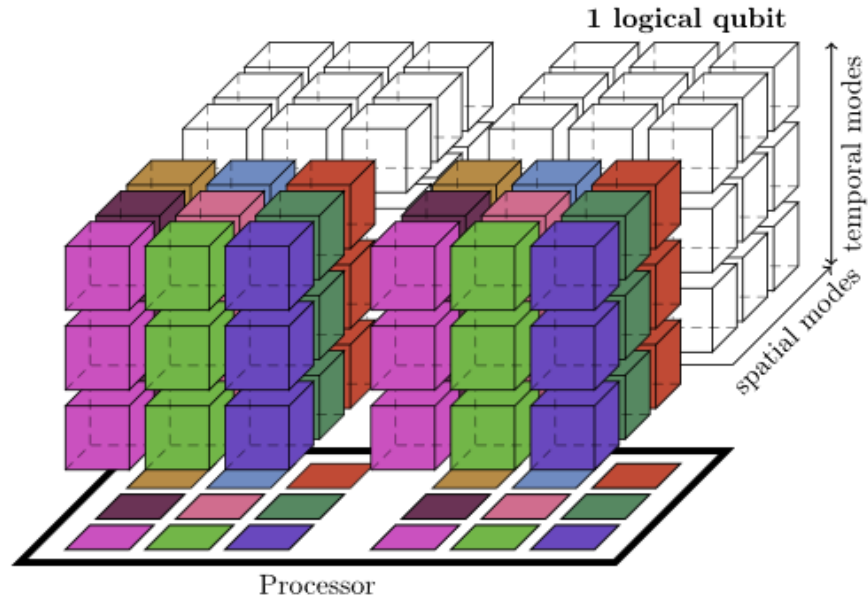

Factoring 2048-bit RSA Integers in 177 Days with 13 436 Qubits and a Multimode Memory, Gouzien & Sangouard, *PRL* (2021)

Quantum memory hierarchies: Efficient designs to match available parallelism in quantum computing, Thaker et al., Symposium on Computer Architecture (2006).

Enable long-distance communication



The quantum internet, H. J. Kimble, *Nature* (2008)

Ideal candidate : Bismuth donors in silicon

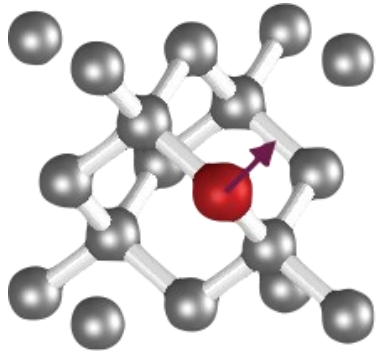

^{209}Bi

Nuclear spin
 $I = 9/2$

Ideal candidate: Bismuth donors in silicon

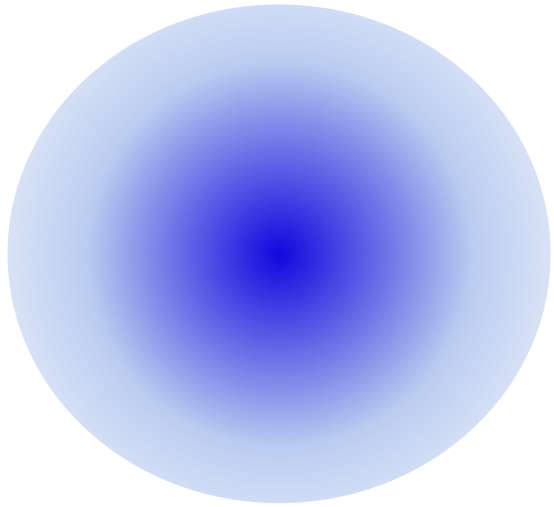

Nuclear spin
 $I = 9/2$

Electronic spin
 $S = 1/2$

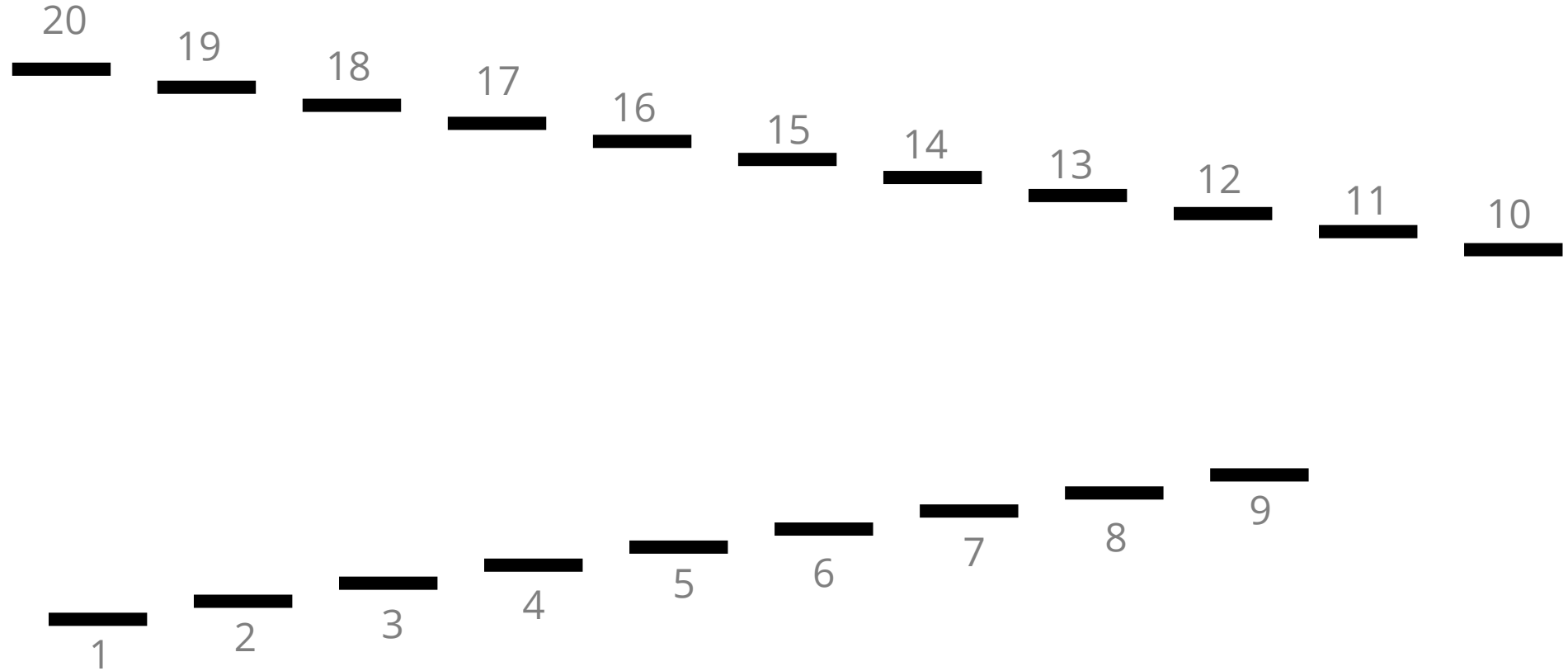

$$\frac{H}{\hbar} = \underbrace{AI \cdot \mathbf{S}}_{\text{HYPERFINE}} + \underbrace{\mathbf{B}_0 \cdot (-\gamma_e \mathbf{S} + \gamma_n \mathbf{I})}_{\text{ZEEMAN EFFECT}}$$

Ideal candidate: Bismuth donors in silicon

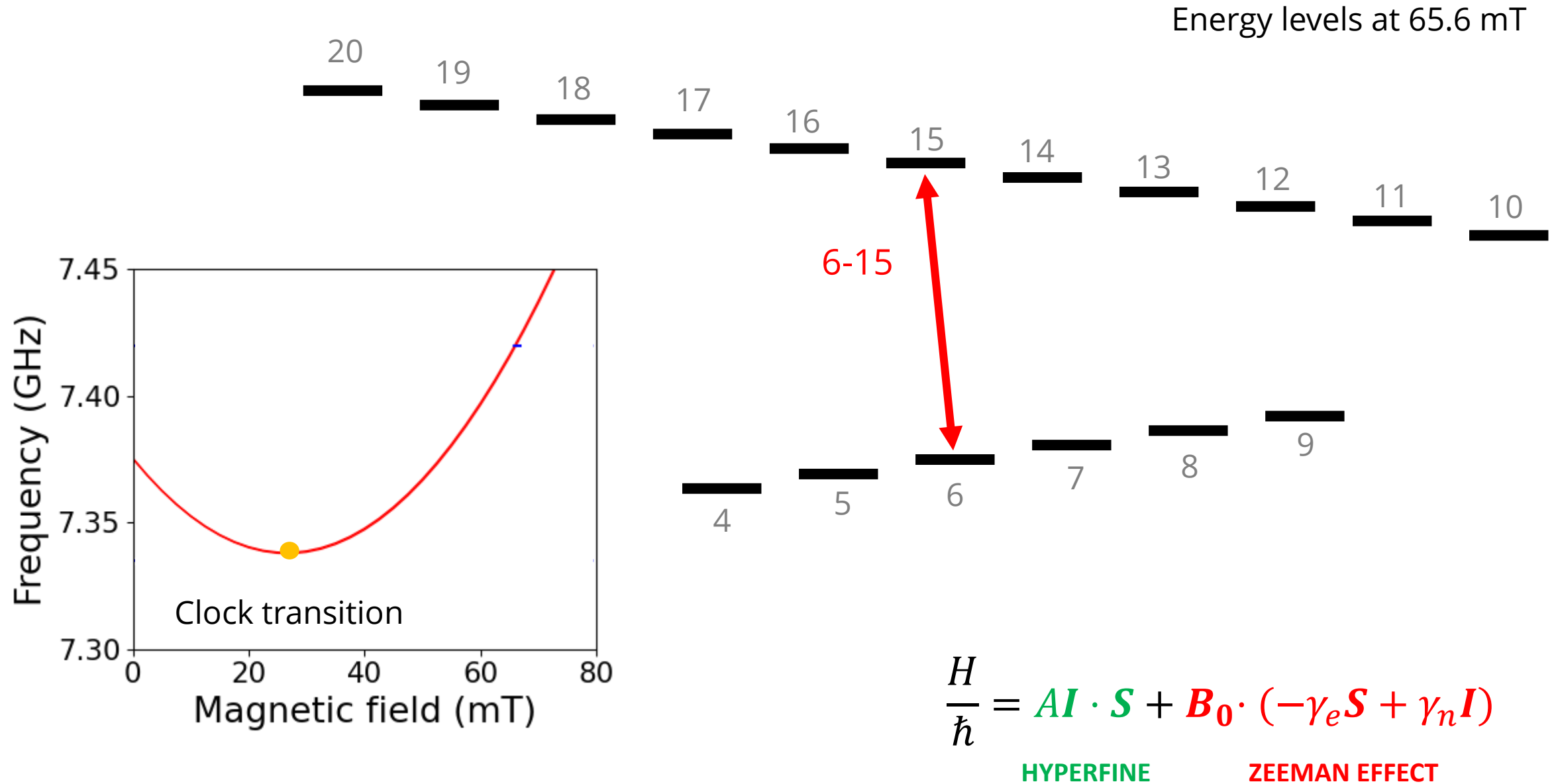

Bismuth donors in silicon

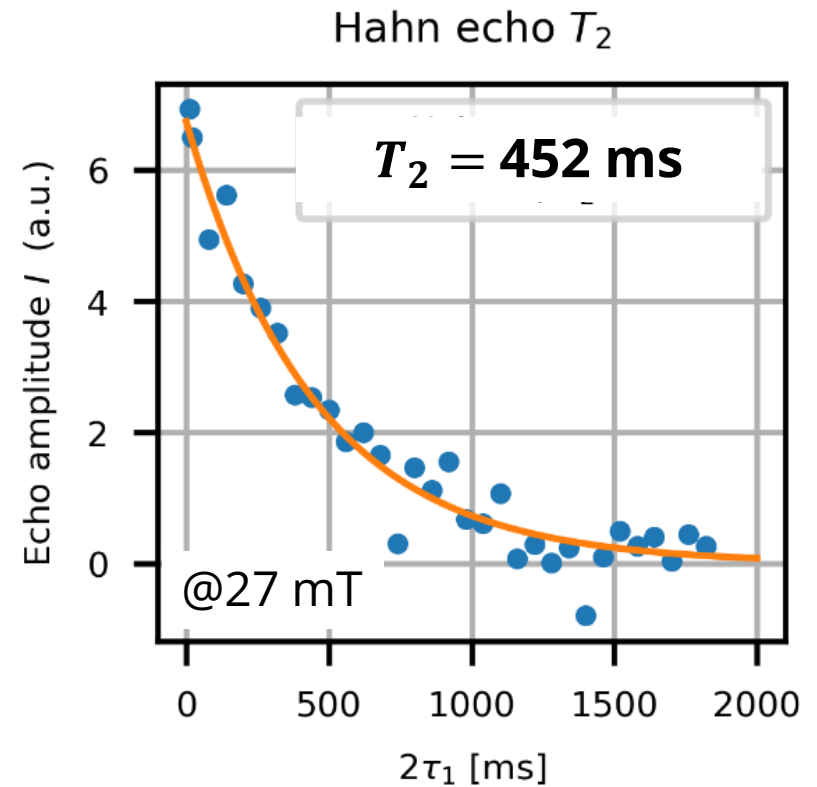
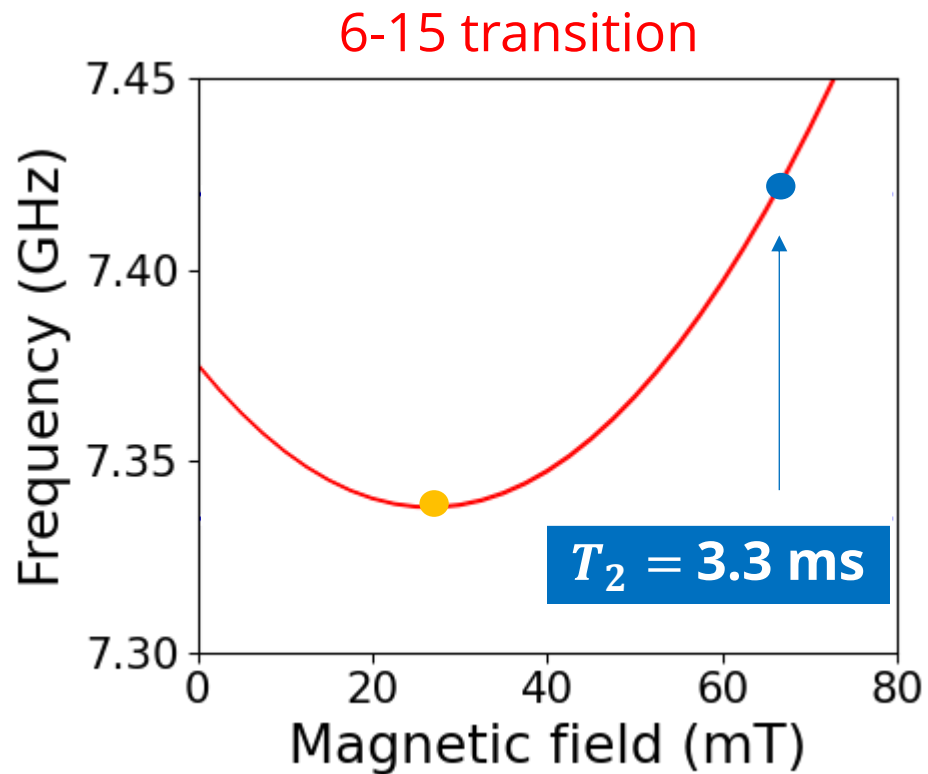
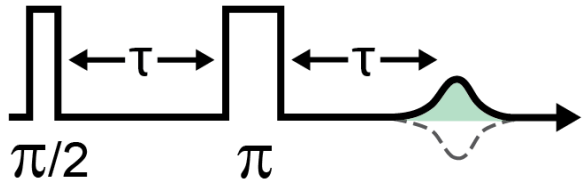

Spin ensemble coupled to a superconducting resonator

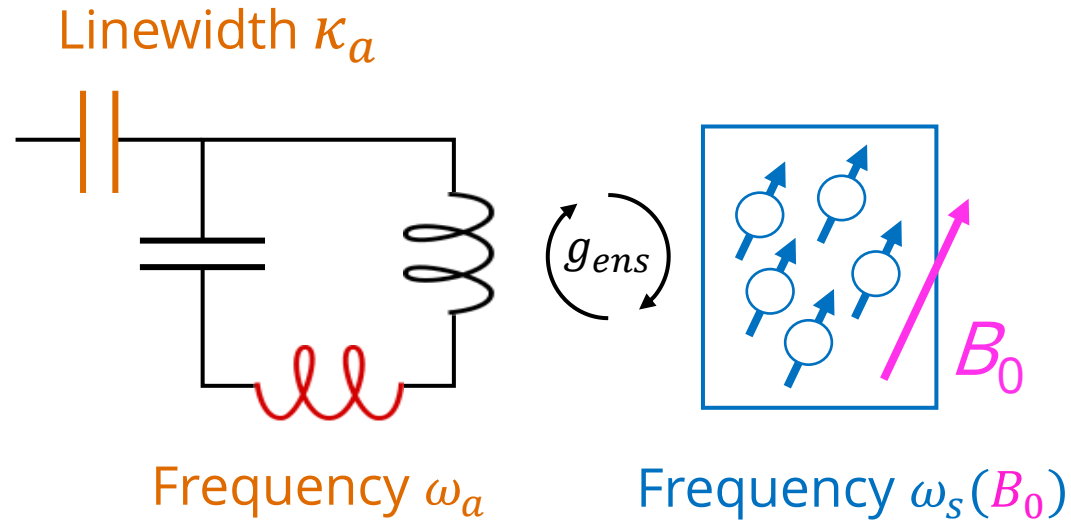

$$H = \mu (\vec{B}_0 + \vec{B}_1) \cdot \vec{S}$$

$$H_{\text{int}} = \underbrace{\mu \delta B_1}_{\text{Coupling constant}} (a + a^\dagger) (\sigma_+ + \sigma_-)$$

Coupling constant $\frac{g_0}{2\pi} = 1 \text{ mHz} - 5 \text{ kHz}$

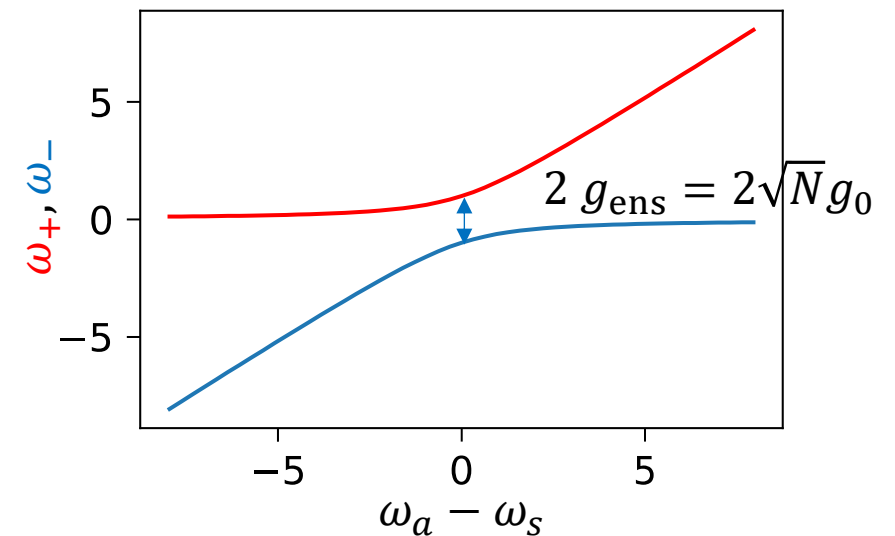

Spin ensemble coupled to a superconducting resonator

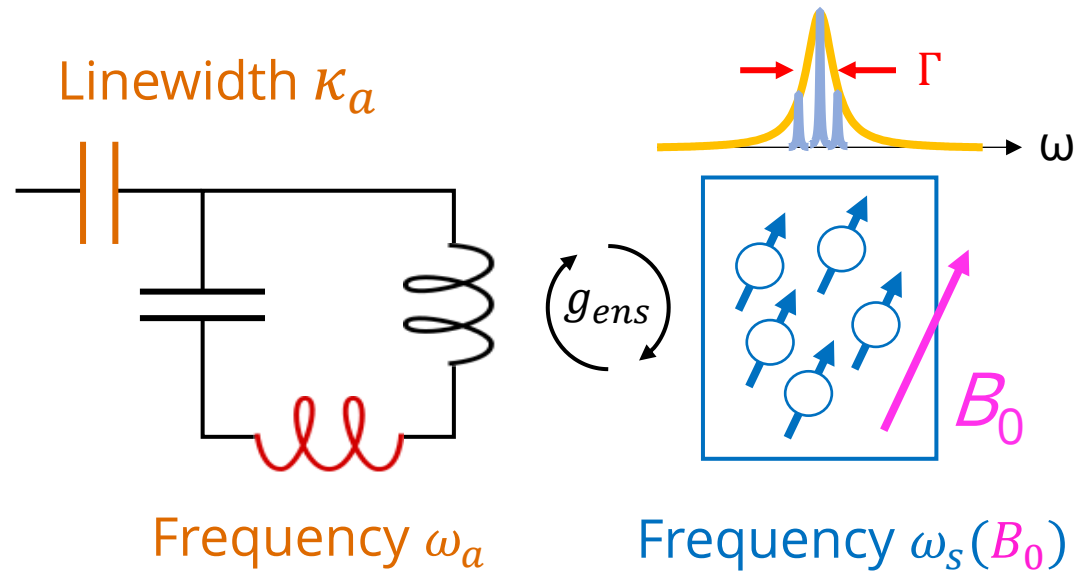

Regime of interaction given by cooperativity

$$C = \frac{4 g_{ens}^2}{\kappa_a \Gamma} = \frac{4 N g_0^2}{\kappa_a \Gamma}$$

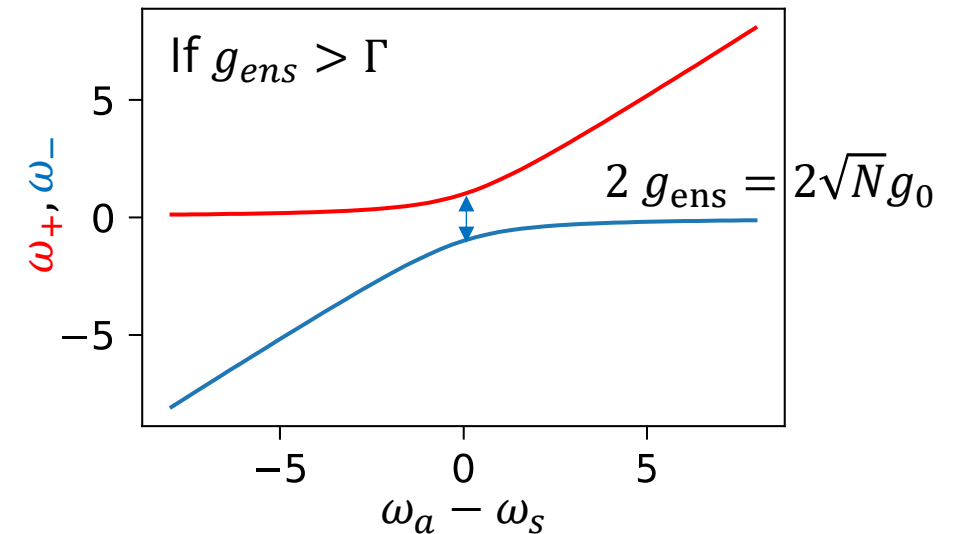

Spin ensemble coupled to a superconducting resonator

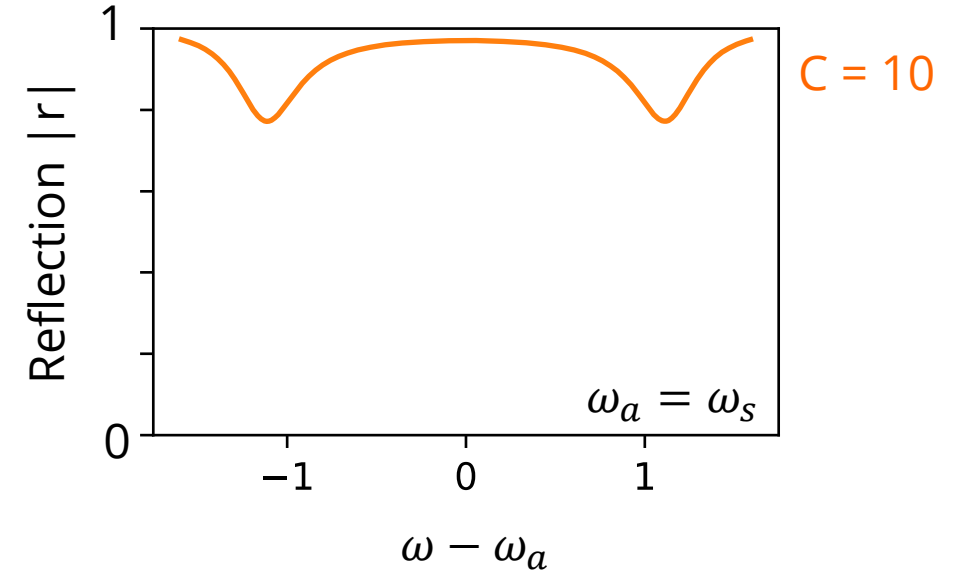
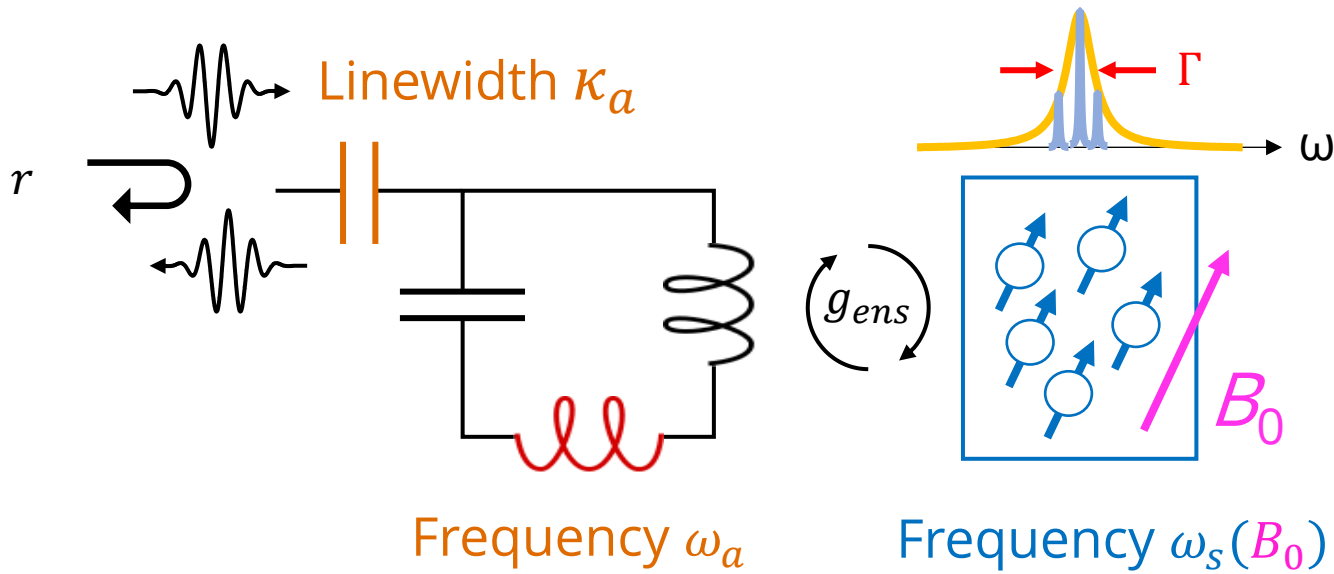

High cooperativity

Signature of avoided level crossings

Coherent swaps between resonators and spins, with exchange time limited by $1/\Gamma$

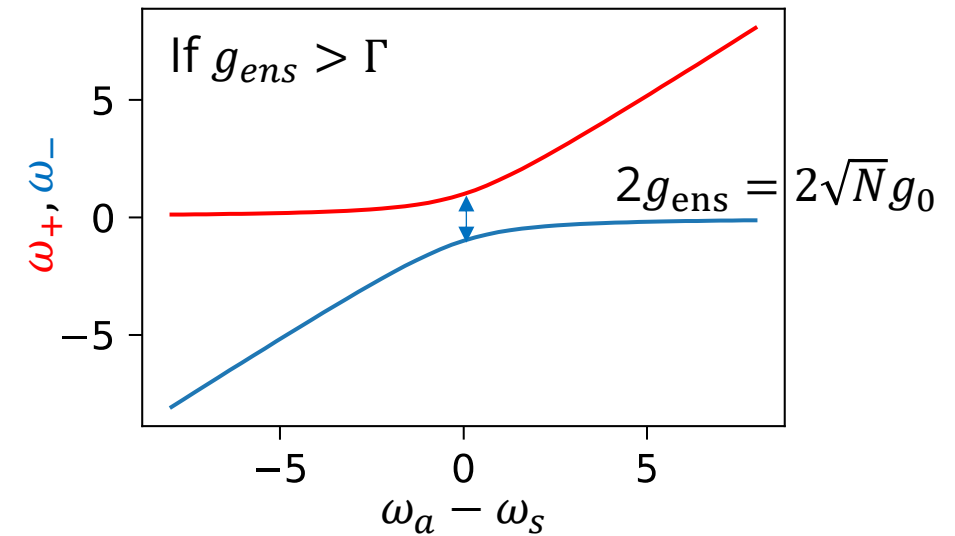

Spin ensemble coupled to a superconducting resonator

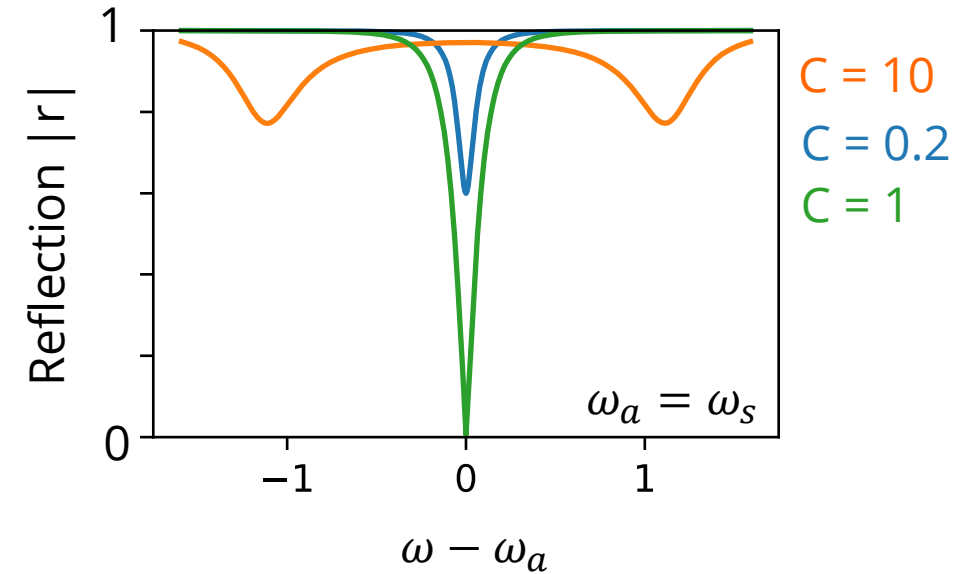
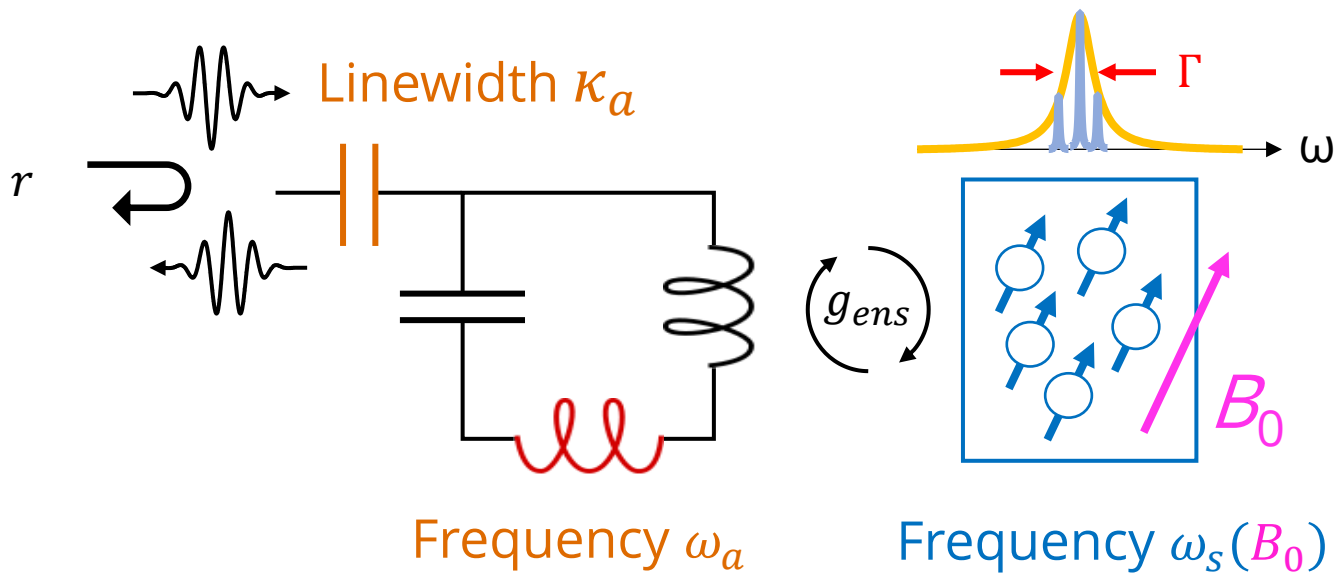

High cooperativity

Signature of avoided level crossings

Coherent swaps between resonators and spins, with exchange time limited by $1/\Gamma$

Unit cooperativity

Perfect absorption into the spins

No coherent swapping

Low cooperativity

Spins act as a loss channel

No coherent swapping

Possible to drive the spins classically by applying a coherent drive on the resonator

Spins can deexcite via the resonator (Purcell effect)

Spin ensemble as a memory: protocol

How to store an incoming arbitrary wave packet and retrieve it?

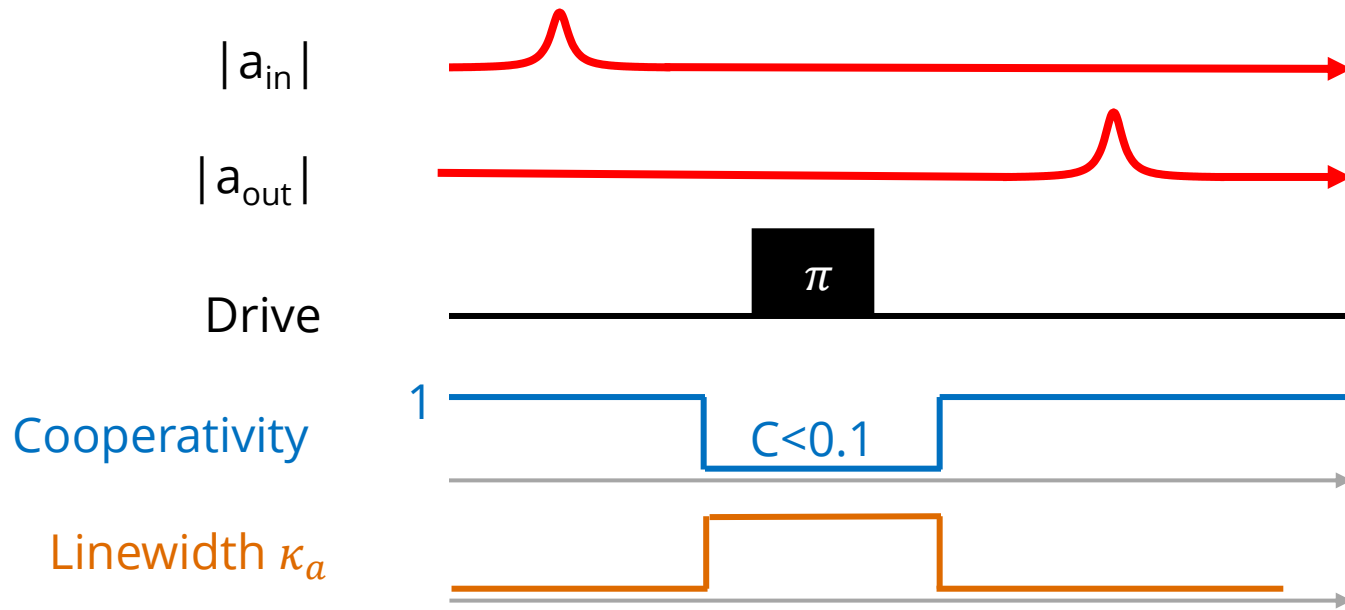

Spin ensemble as a memory: protocol

How to store an incoming arbitrary wave packet and retrieve it?

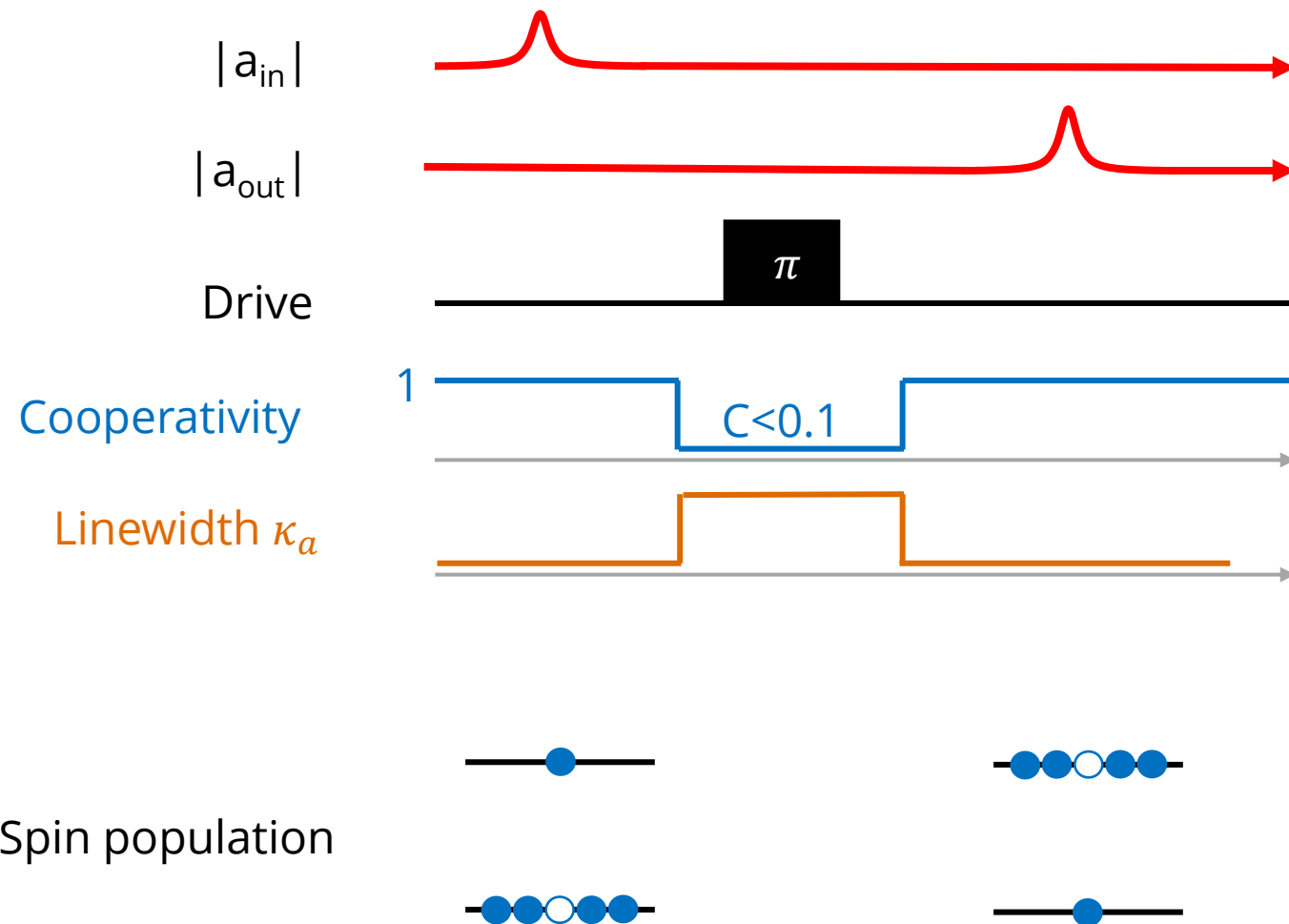

Spin ensemble as a memory: protocol

How to store an incoming arbitrary wave packet and retrieve it?

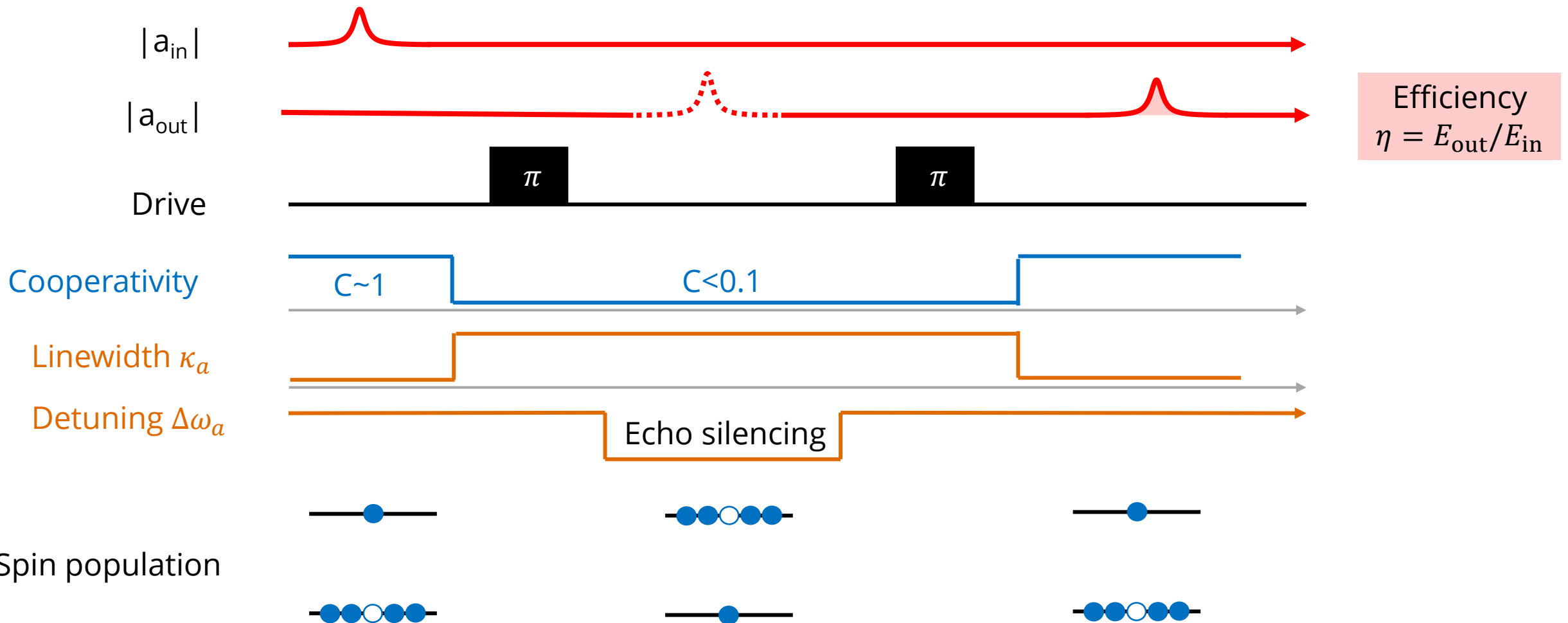

Multimode?

Random access to multiple stored states by echo silencing... except on retrieval !

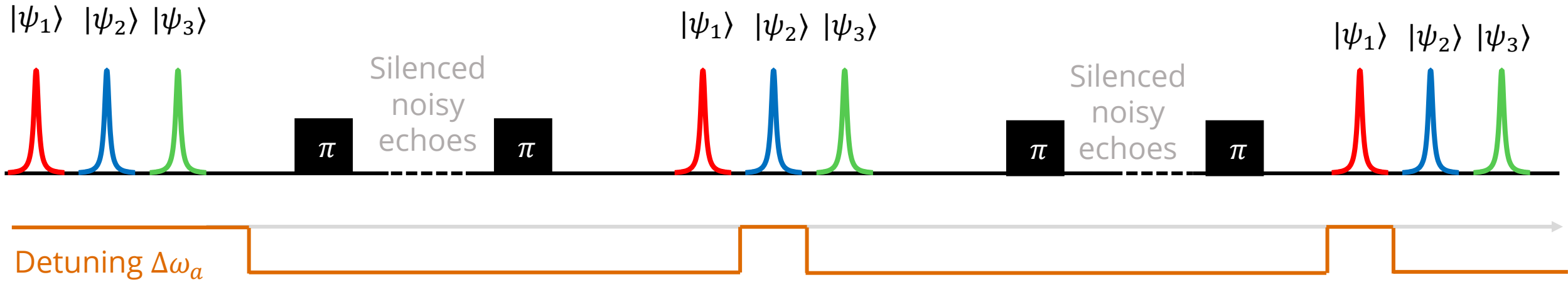

Spin-ensemble as a memory : requirements & state of the art

- ✓ Long spin coherence
 - ✓ Aim for clock transitions
- ✓ Tunable resonator frequency
 - ✓ For echo silencing
 - ✓ For aiming for clock transitions
- X Tunable linewidth
- X Reach unit cooperativity

NV centers in diamond

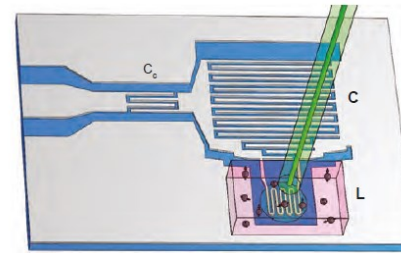

Grezes et al., *PRA* (2015)

Efficiency 0.3 %

$$C = 0.22$$

$$T_2 = 84 \text{ us}$$

Bismuth donors in silicon

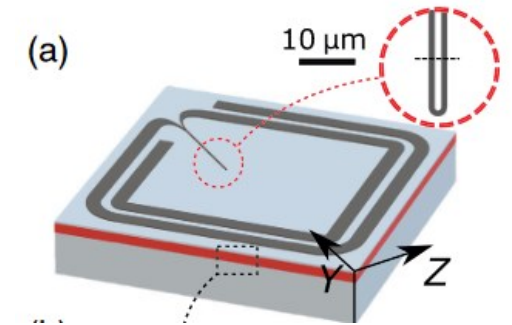

Ranjan
PRL (2020)

Efficiency 0.1 %

$$C = 0.04$$

$$T_2 = 0.3 \text{ s}$$

O'Sullivan
PRX (2022)

Efficiency 3 %

$$C = 0.06$$

$$T_2 = 2 \text{ ms}$$

Perspective

Running a protocol maximizing efficiency for classical pulses

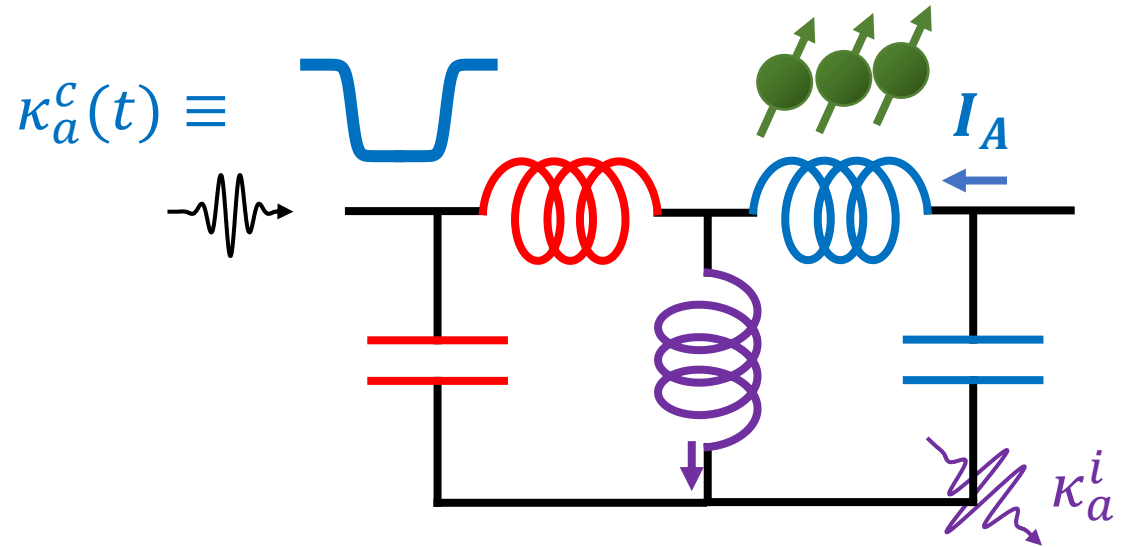

Building a bidirectional link between qubit and processor

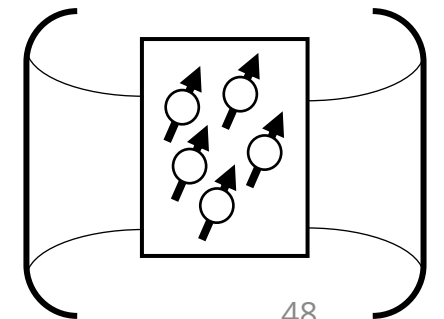
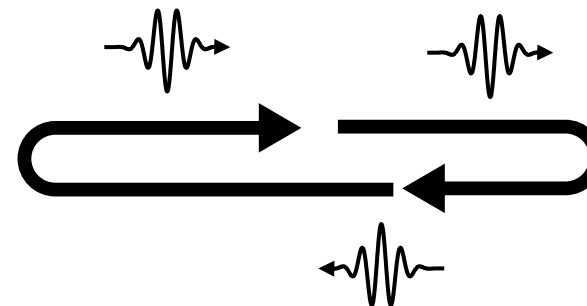
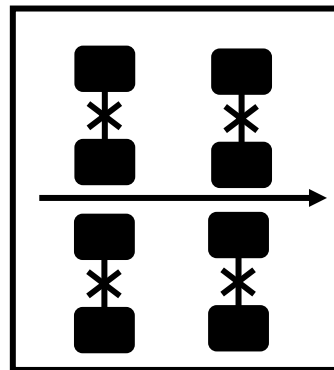

Acknowledgments

Quantum circuit group, summer 2024

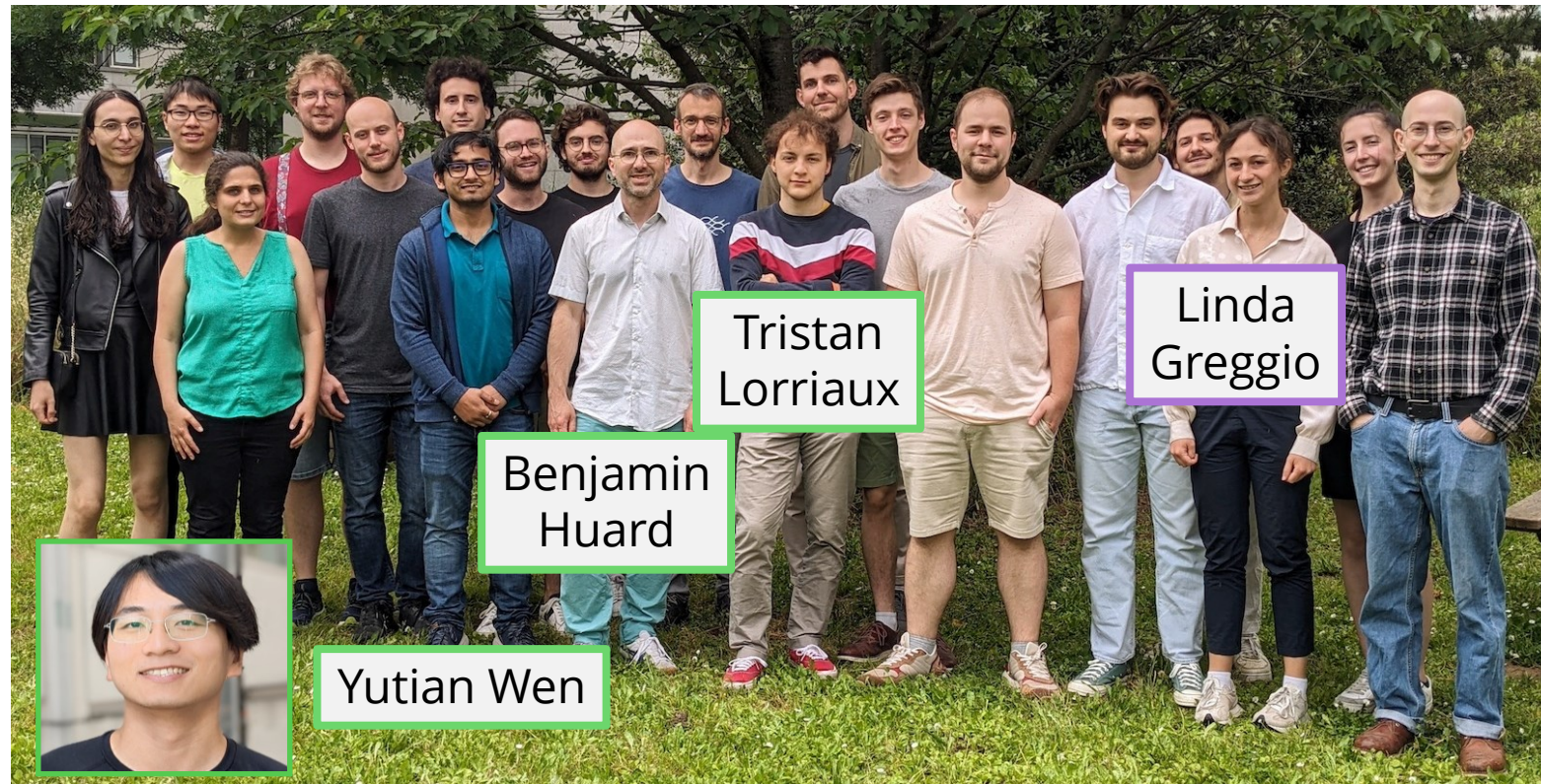

M. Mirrahimi
Inria Paris



V. Ranjan
IIESR Hyberabad



D. Vion
CEA-Saclay



A. Petrescu
Inria Paris

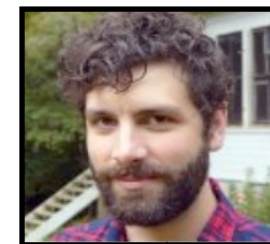

E. Flurin
CEA-Saclay



P. Bertet
CEA-Saclay



anr[®]
agence nationale
de la recherche



OPEN POST-DOC POSITIONS !