



HAL
open science

Quantum computing description of strongly interacting atomic nuclei: challenges and opportunities

D Lacroix

► **To cite this version:**

D Lacroix. Quantum computing description of strongly interacting atomic nuclei: challenges and opportunities. Quantum computing for quantum chemistry, Nov 2024, Montpellier, France. hal-04799783

HAL Id: hal-04799783

<https://hal.science/hal-04799783v1>

Submitted on 23 Nov 2024

HAL is a multi-disciplinary open access archive for the deposit and dissemination of scientific research documents, whether they are published or not. The documents may come from teaching and research institutions in France or abroad, or from public or private research centers.

L'archive ouverte pluridisciplinaire **HAL**, est destinée au dépôt et à la diffusion de documents scientifiques de niveau recherche, publiés ou non, émanant des établissements d'enseignement et de recherche français ou étrangers, des laboratoires publics ou privés.



Distributed under a Creative Commons Attribution - NonCommercial 4.0 International License

Quantum computing description of strongly interacting atomic nuclei *and neutrinos*: challenges and opportunities

Denis Lacroix

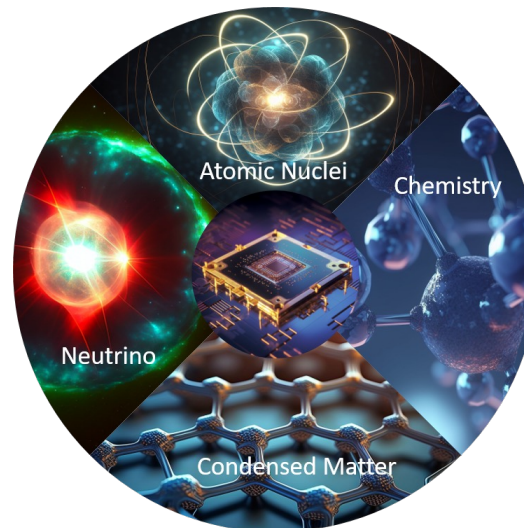

Many-body physics and QC - T. Ayrat, P. Besserve, D. Lacroix, and E.A. Ruiz Guzman ,
Quantum computing with and for many-body physics, EPJA 59 (2023)

Symmetry and QC – D. Lacroix, A. Ruiz Guzman and P. Siwach,
Symmetry breaking/symmetry preserving circuits and symmetry restoration on quantum computers
EPJA 59 (2023)

CERN Quantum Initiative – Di Meglio et al., Quantum Computing for High-Energy Physics: State of the
Art and Challenges, PRX Quantum 5, 037001 (2024)

Short highlights of our fundamental science motivations

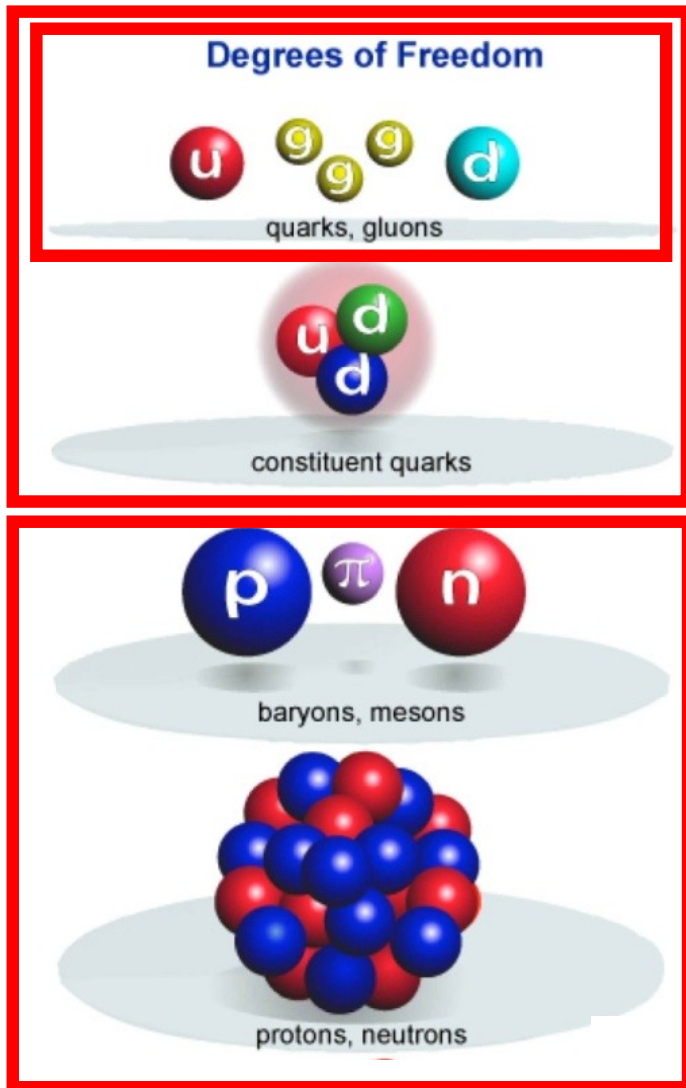

Energy (MeV)

940
neutron mass

140
pion mass

8
proton separation
energy in lead

➔ Physics beyond the standard model
From quarks to nucleons?

➔ From nucleons
to atomic nuclei?

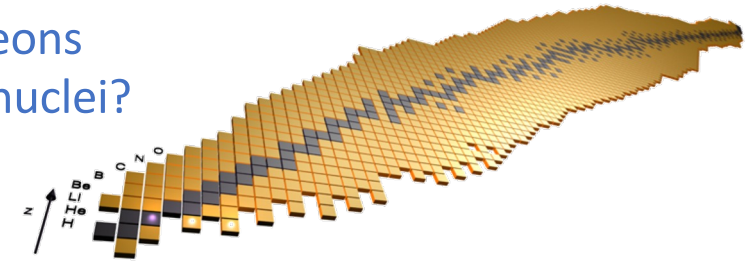

➔ QC for simulation of specific
Astrophysics process

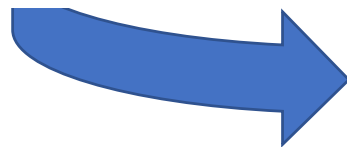
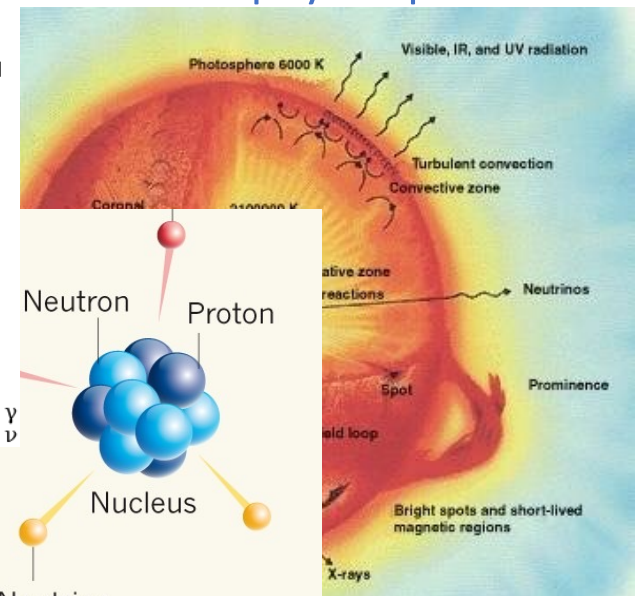
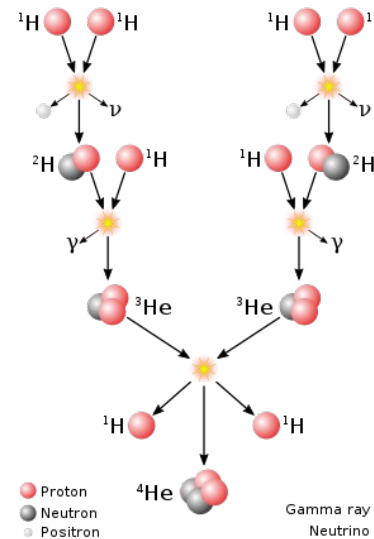

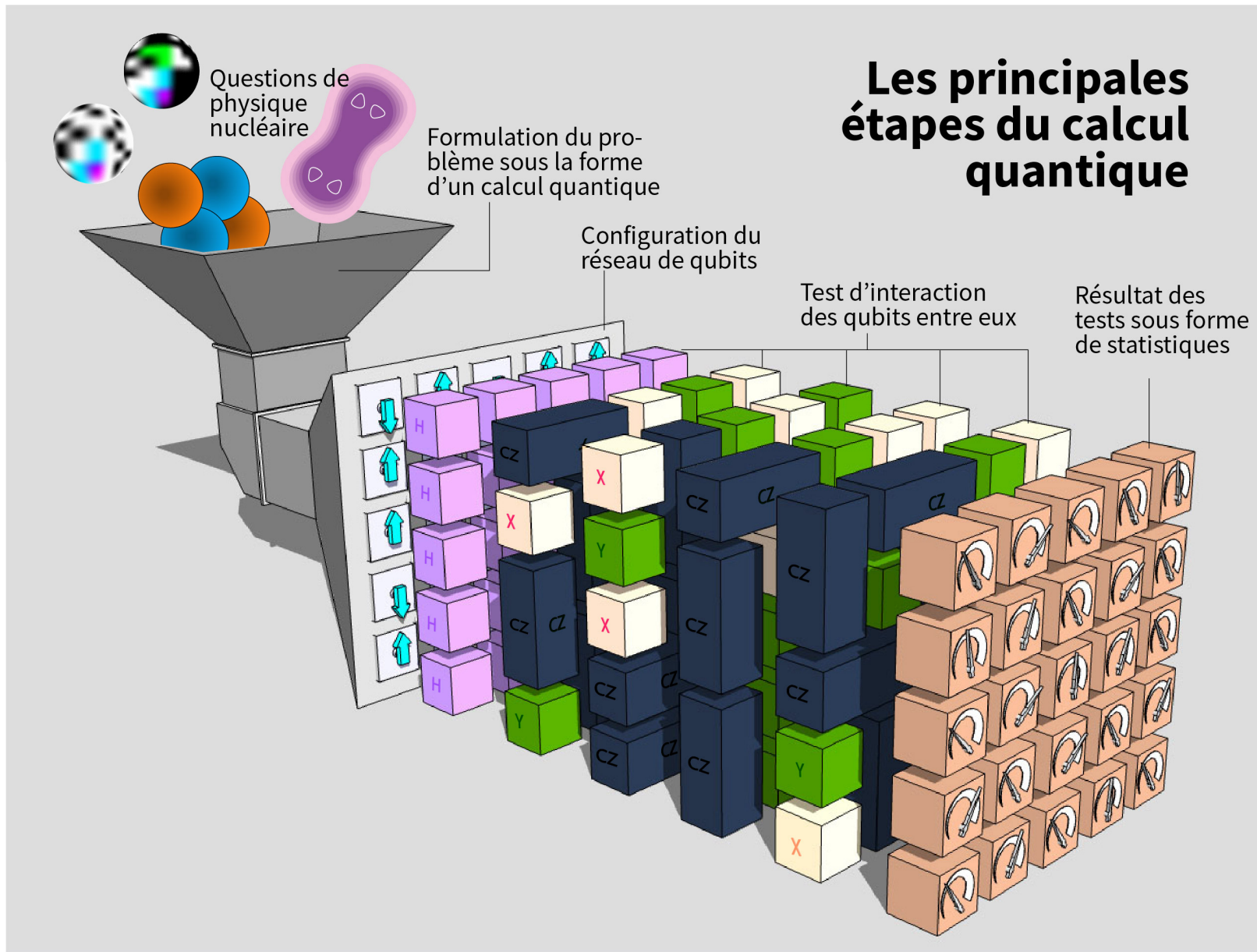



Particles & Interactions

Simulation

Phases & Dynamics of Matter

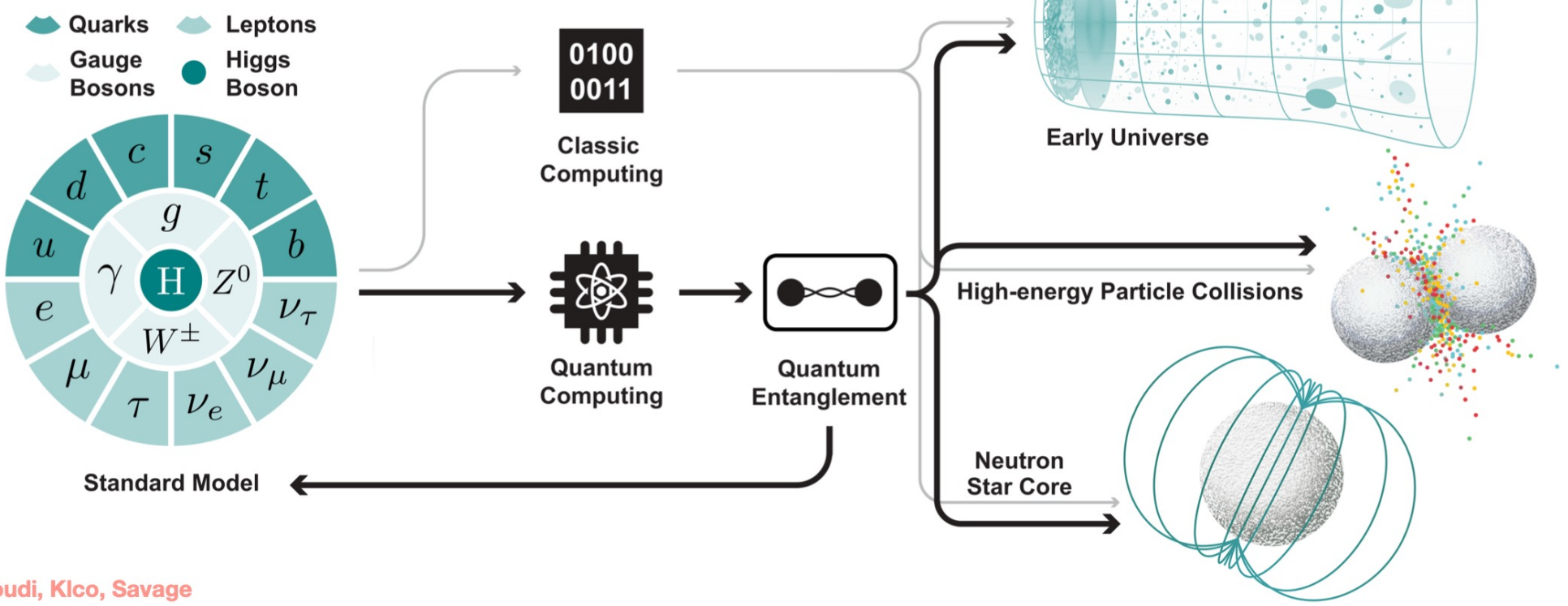



Digital Quantum Chromodynamics

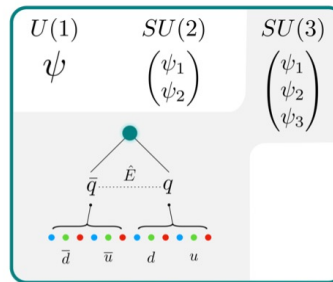
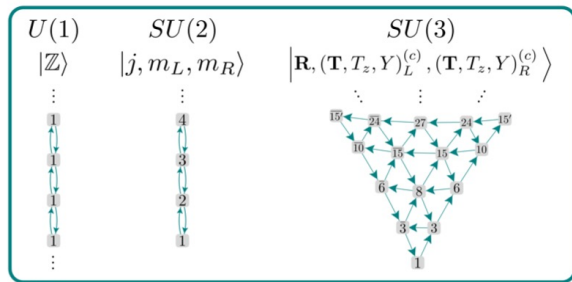

$$\hat{H} \sim g^2 |\hat{E}(\mathbf{x})|^2 - \frac{1}{g^2} \text{Tr} [\hat{U}_1 \hat{U}_2 \hat{U}_3 \hat{U}_4^\dagger + \text{h.c.}] + \hat{H}_\psi$$

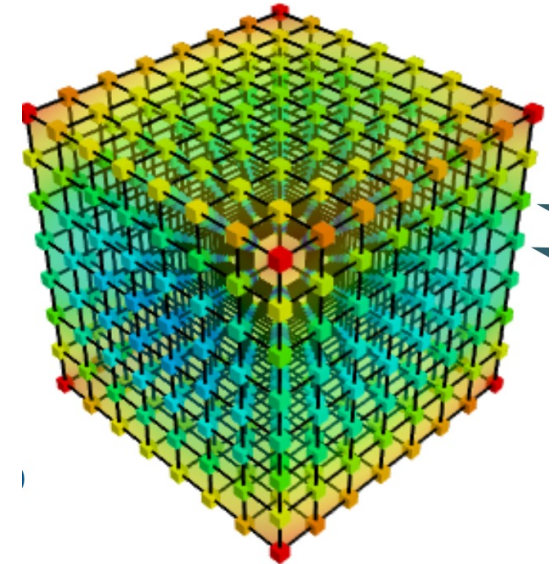
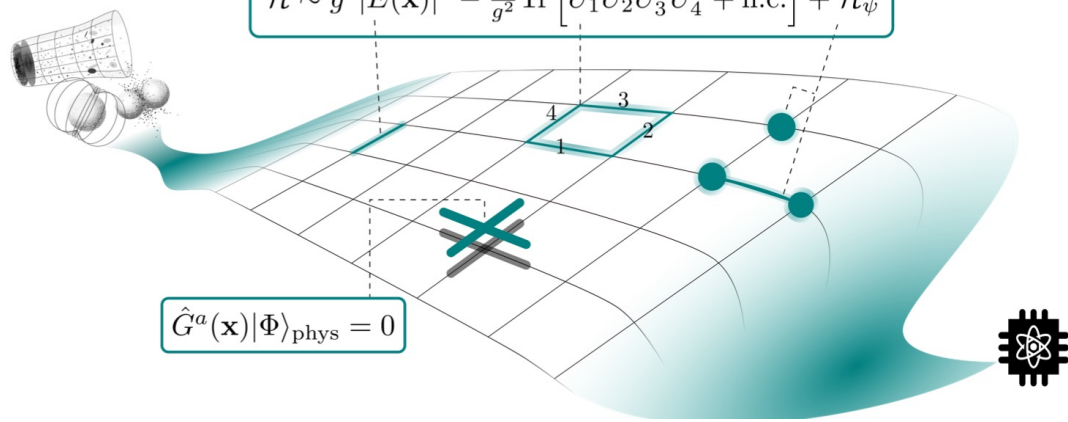

- ➔ Map quarks and gluons on quantum register
- ➔ Develop unitary operators for their evolution
- ➔ Obtain relevant observables from measurements

A focus on neutrino oscillation physics simulated on quantum computers

Neutrino mass and oscillations

Three Generations of Matter (Fermions) spin 1/2

	I	II	III
mass	2.4 MeV	1.27 GeV	171.2 GeV
charge	2/3	2/3	2/3
name	Left up Right	Left charm Right	Left top Right
Quarks	Left down Right	Left strange Right	Left bottom Right
Leptons	Left electron neutrino Right	Left muon neutrino Right	Left tau neutrino Right
Leptons	Left electron Right	Left muon Right	Left tau Right

Bosons (Forces) spin 1

0	g
0	γ
91.2 GeV	Z
80.4 GeV	W [±]

M(H) ≈ 126 GeV

>114 GeV	H
0	spin 0

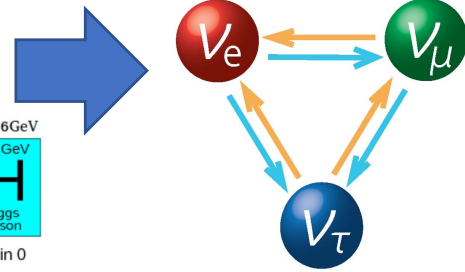

3 masses case

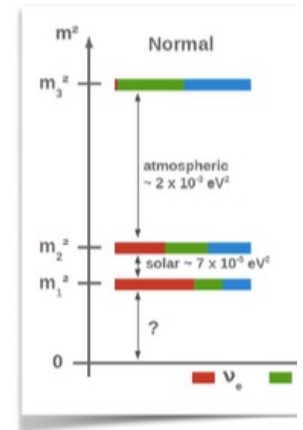
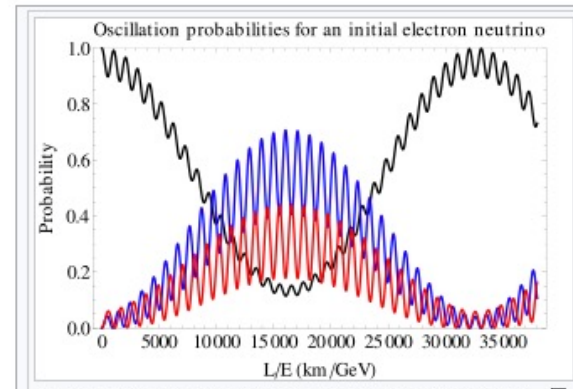

Neutrino are "natural" qutrits

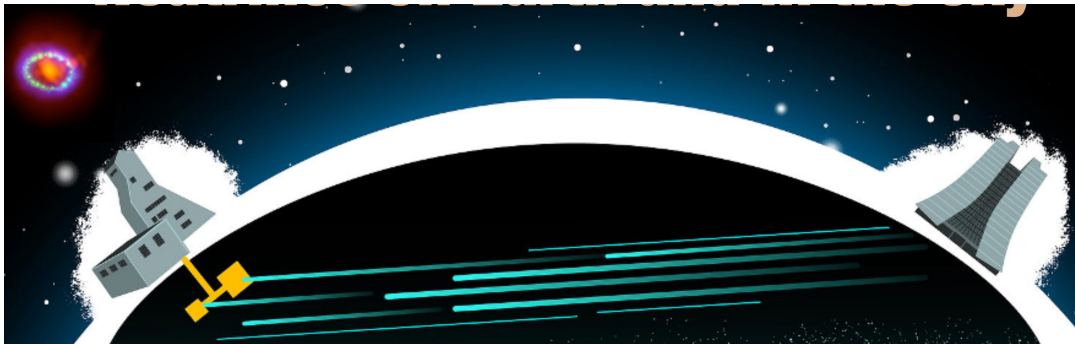

2 masses approximation

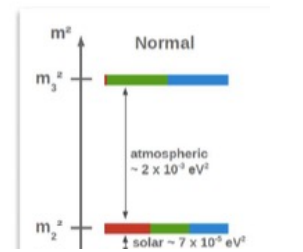
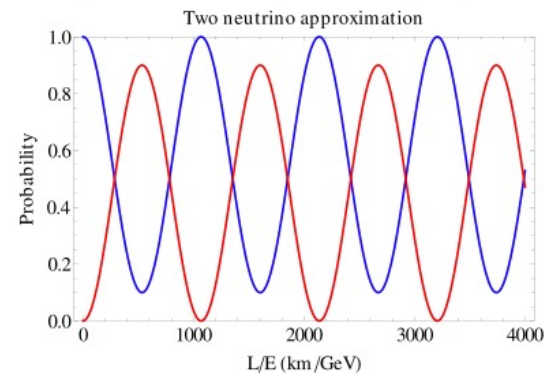

Neutrino on qubits or as qubits

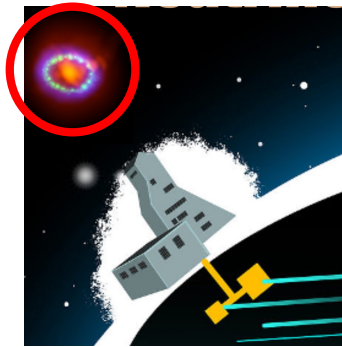
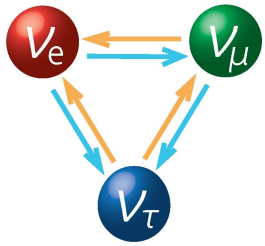

Neutrino fluxes at Earth

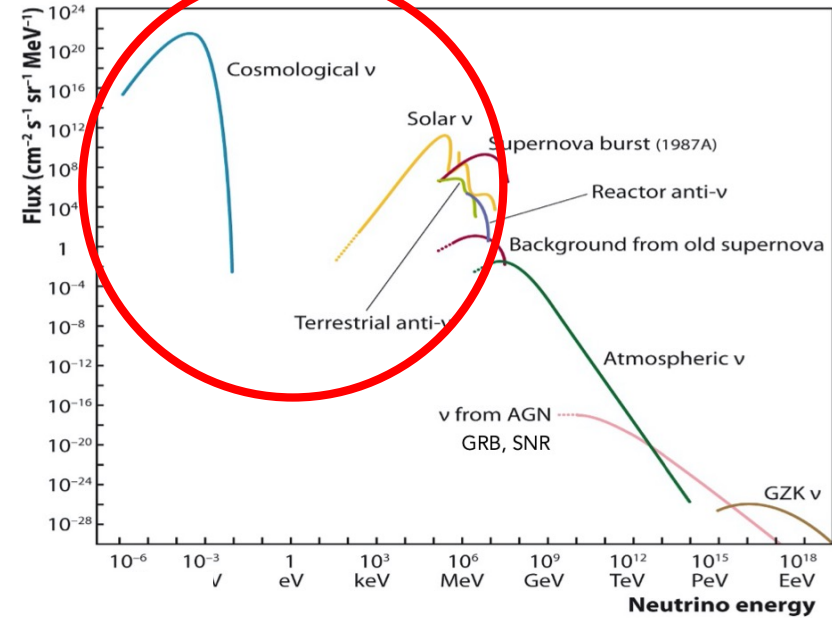

Where is the complexity?

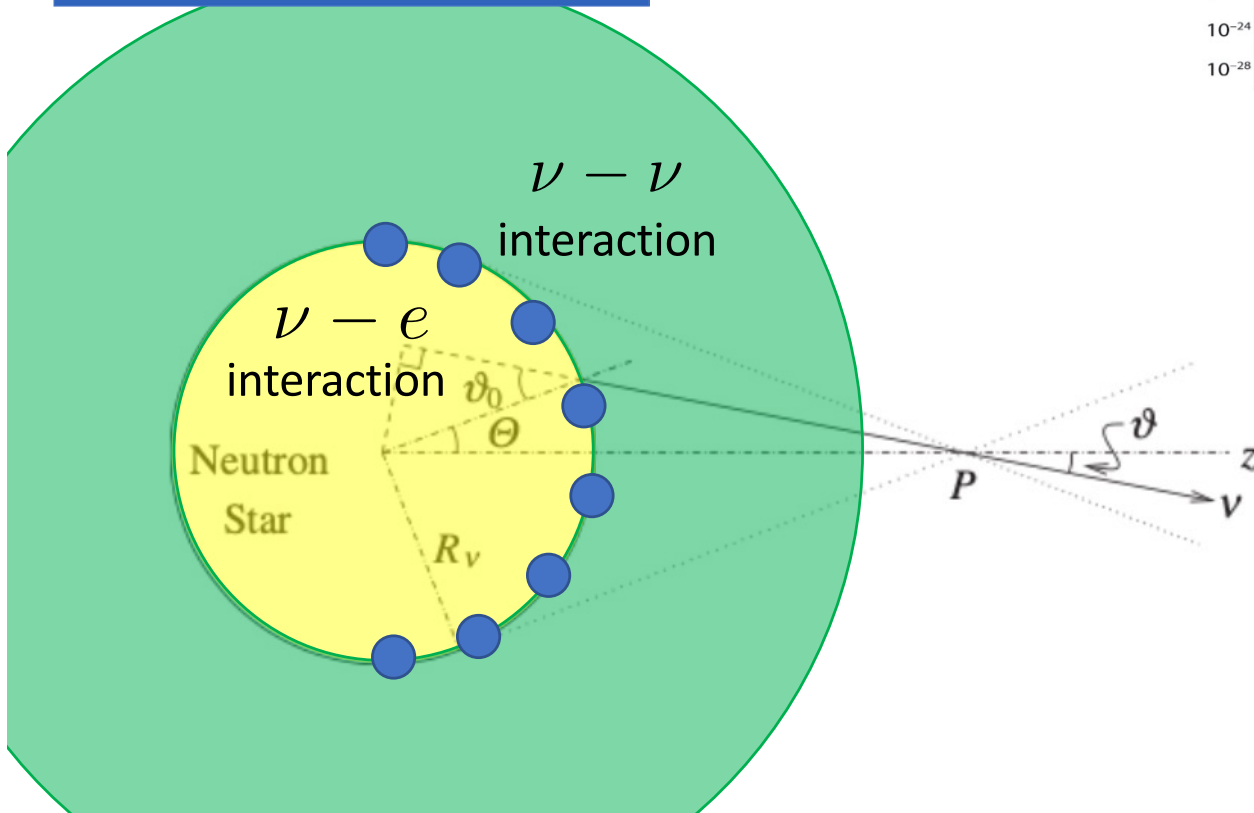

The problem is mapped to a many-body open quantum system problem equivalent to interacting qubits or qutrits.

Illustration of the Hamiltonian (2 flavor approx)

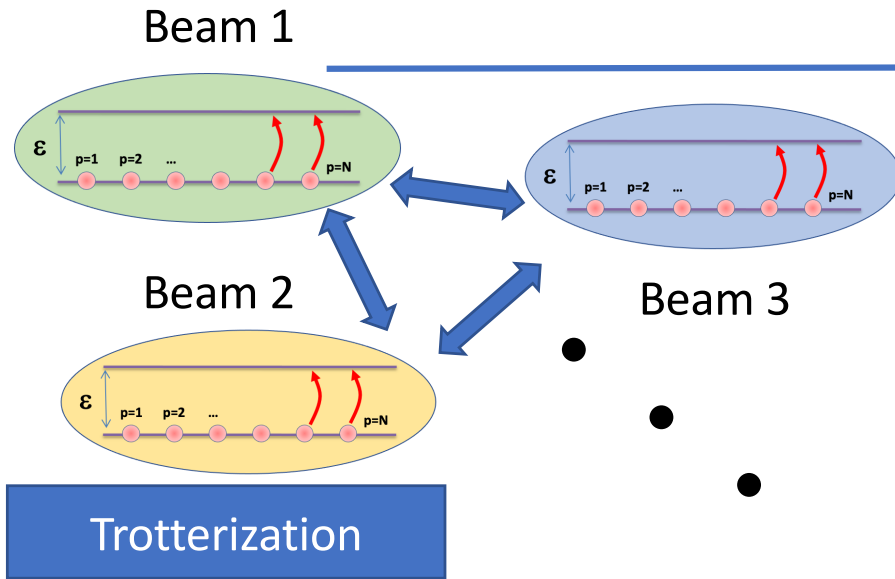

Oscillation

$$H_\nu = \frac{1}{N} \sum_{i=0}^{N-1} \sin(2\theta_\nu) X_i - \cos(2\theta_\nu) Z_i$$

Coupling

$$H_{\nu\nu} = \sum_{i<j}^{N-1} G_{i,j} [X_i X_j + Y_i Y_j + Z_i Z_j].$$

1. Decomposition of H into elementary blocks
2. Use a transformation (Trotter-Suzuki)

Example : $e^{i\Delta t H_1/\hbar} = e^{-i\Delta t H_1/\hbar} e^{-i\Delta t H_2/\hbar}$

3. Transforms to circuit

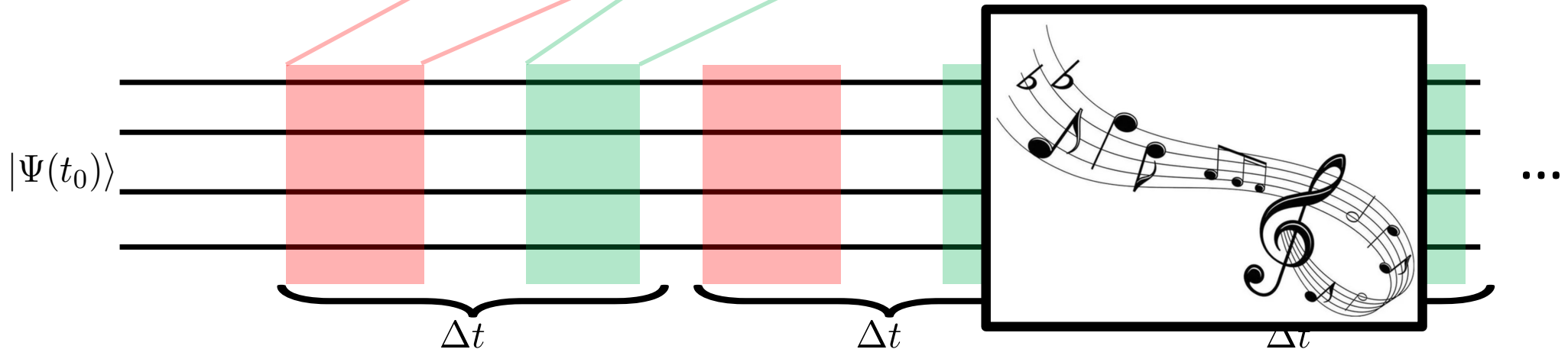

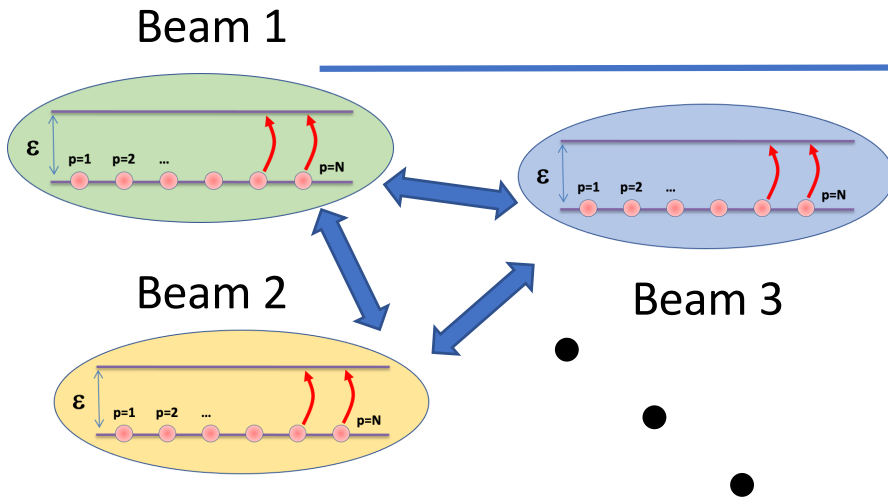

Illustration of the Hamiltonian (2 flavor approx)

Oscillation

$$H_\nu = \frac{1}{N} \sum_{i=0}^{N-1} \sin(2\theta_\nu) X_i - \cos(2\theta_\nu) Z_i$$

Coupling

$$H_{\nu\nu} = \sum_{i < j}^{N-1} G_{i,j} [X_i X_j + Y_i Y_j + Z_i Z_j].$$

$$H_\nu = \frac{1}{N} \sum_{i=0}^{N-1} \sin(2\theta_\nu) X_i - \cos(2\theta_\nu) Z_i$$

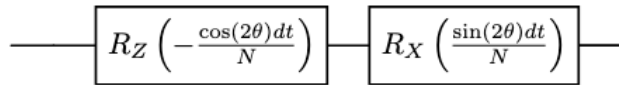

$$H_{\nu\nu} = \sum_{i < j}^{N-1} G_{i,j} [X_i X_j + Y_i Y_j + Z_i Z_j].$$

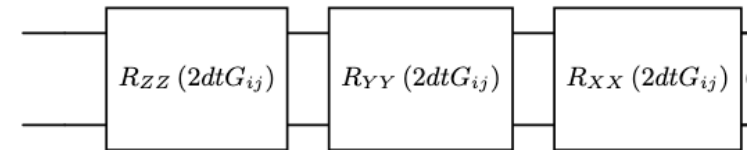

or with optimization

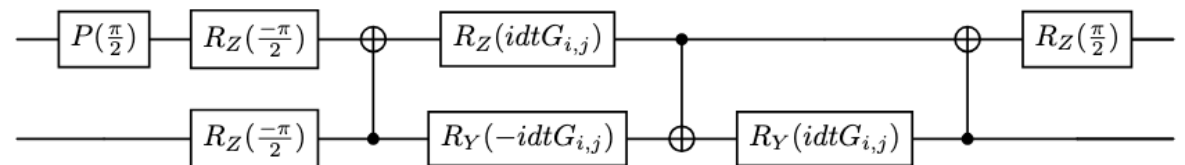

A focus on neutrino oscillation physics simulated on quantum computers

Illustration of the Hamiltonian (2 flavor approx)

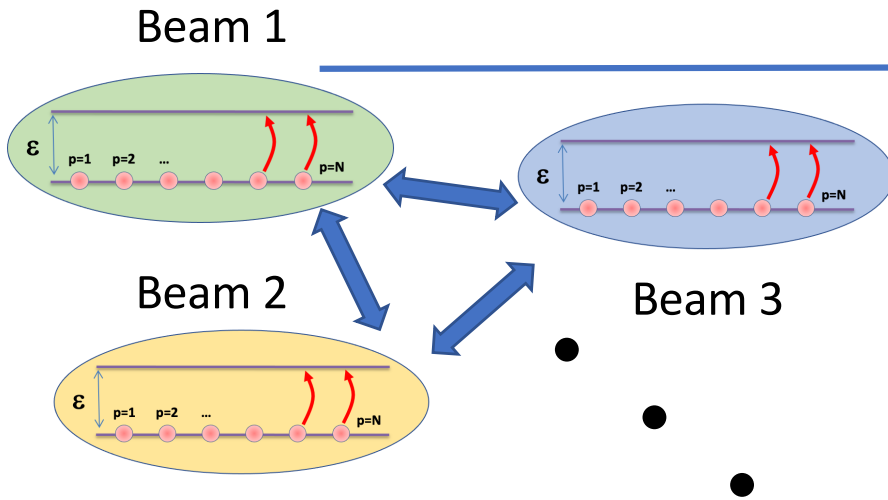

Oscillation
$$H_\nu = \frac{1}{N} \sum_{i=0}^{N-1} \sin(2\theta_\nu) X_i - \cos(2\theta_\nu) Z_i$$

Coupling
$$H_{\nu\nu} = \sum_{i < j}^{N-1} G_{i,j} [X_i X_j + Y_i Y_j + Z_i Z_j].$$

12 neutrinos / qutrits
H1-1 & ibm_torino

12 neutrinos
Quantinuum's H1-1
20 qubit trapped-ion

4 & 8 neutrinos
HQD-H1
Trapped Ion device

4 neutrinos
IBM-Vigo QPU

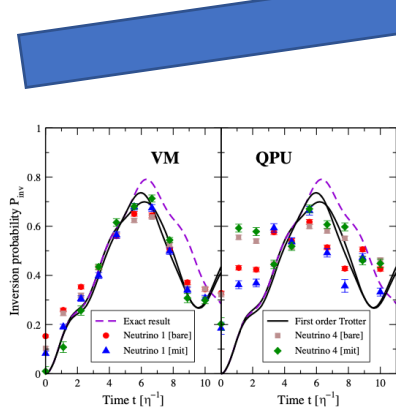

Hall et al, PRD 104 (2021)

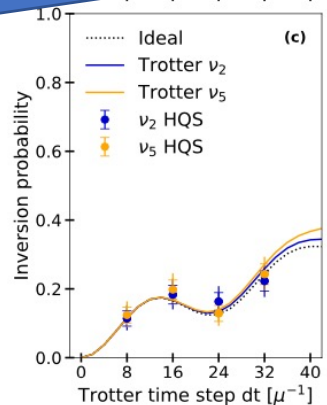

Amitrano, et al, PRD 107, (2023)

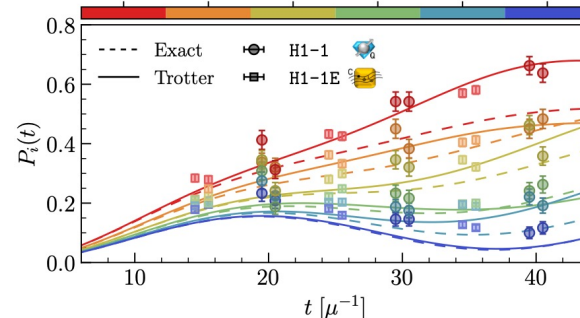

Illa et al, PRL 130 (2023)

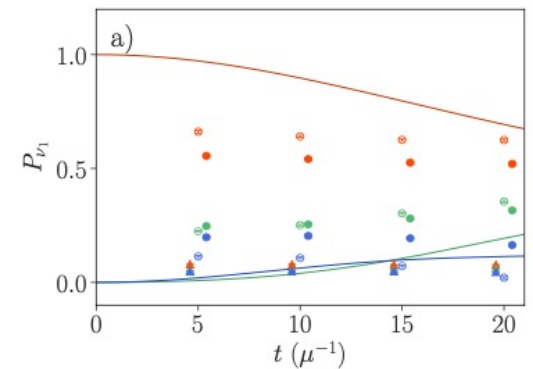

Turro et al, arxiv:2407.13914

Tensor network

Using MPS layers to simulate
neutrino evolution

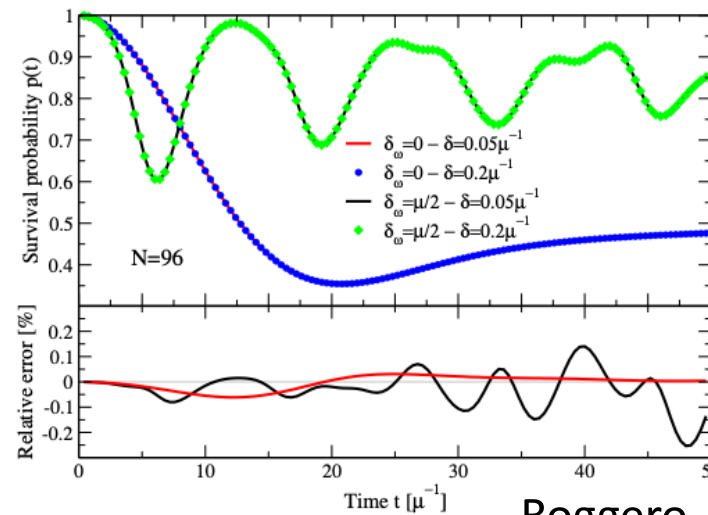

Up to ~ 100 neutrinos

Roggero, Phys. Rev. D 104 (2021)
Cervia et al, Phys. Rev. D 105 (2022)

Phase-space methods

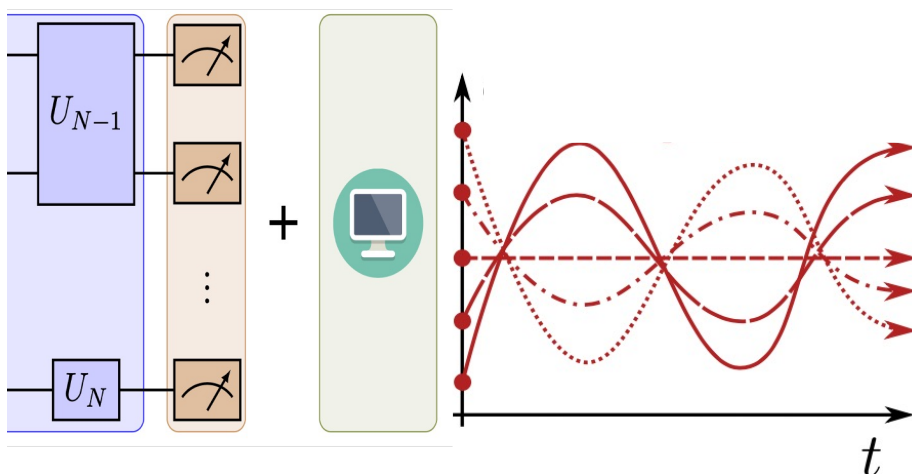

Lacroix et al, 2409.20215, PRD *in press*

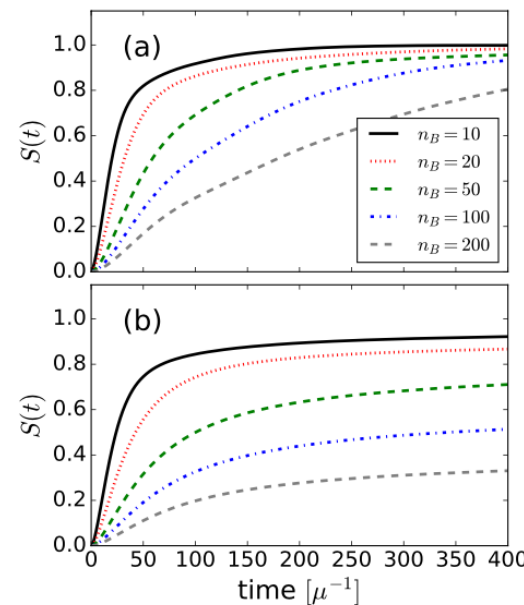

Several hundreds
of neutrinos

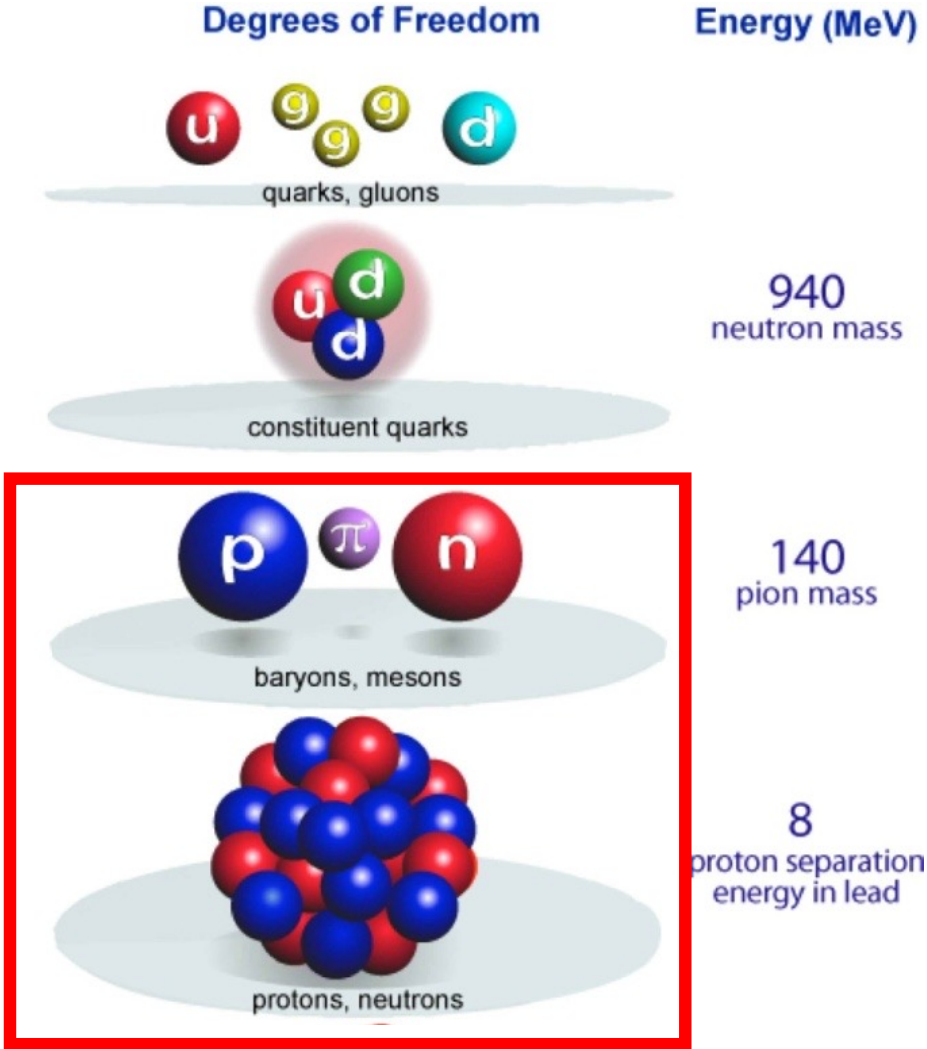

From nucleons to atomic nuclei?

Quantum computing for atomic nuclei

Problematic and challenges

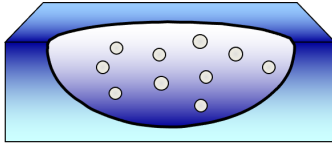
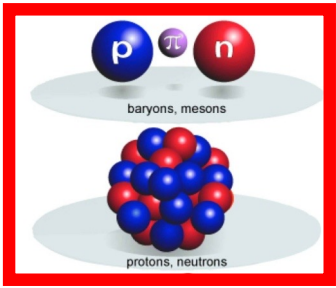

Nuclei are self-bound quantum mesoscopic systems

Nb of particles

$$2 \leq A \leq 300$$

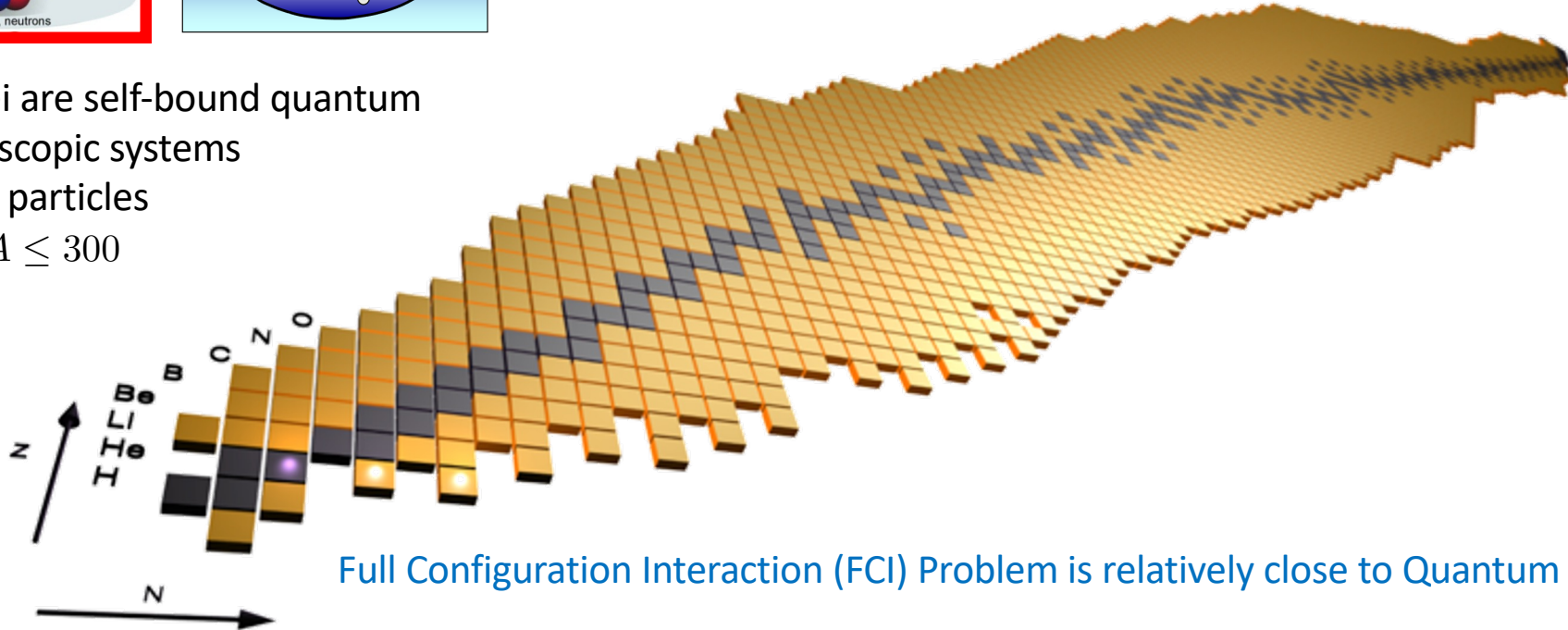

Full Configuration Interaction (FCI) Problem is relatively close to Quantum chemistry

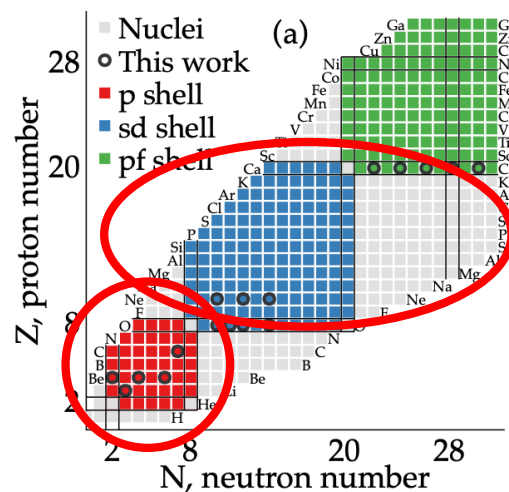

$0f_{5/2}$	19	18	17	16	15	14	
$1p_{1/2}$			13	12			pf
$1p_{3/2}$		11	10	9	8		
$0f_{7/2}$	7	6	5	4	3	2	1
protons							
$0d_{3/2}$		11	10	9	8		
$1s_{1/2}$			7	6			sd
$0d_{5/2}$	5	4	3	2	1	0	
neutrons							
$0p_{1/2}$			5	4			p
$0p_{3/2}$		3	2	1	0		
m	$-\frac{7}{2}$	$-\frac{5}{2}$	$-\frac{3}{2}$	$-\frac{1}{2}$	$\frac{1}{2}$	$\frac{3}{2}$	$\frac{5}{2}$

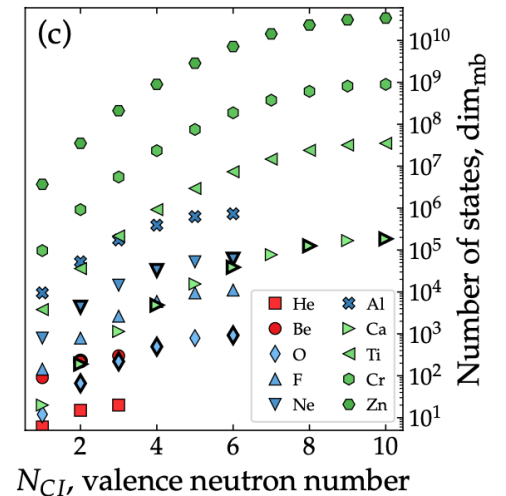

Quantum computing for atomic nuclei

Problematic and challenges

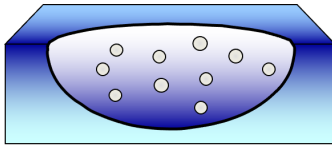
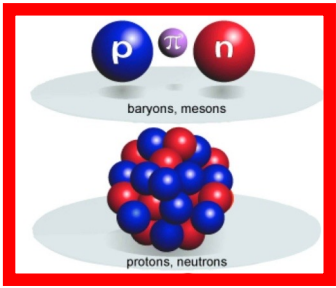

Nuclei are self-bound quantum mesoscopic systems

Nb of particles

$$2 \leq A \leq 300$$

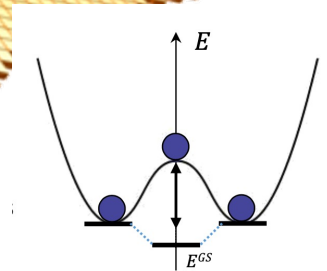
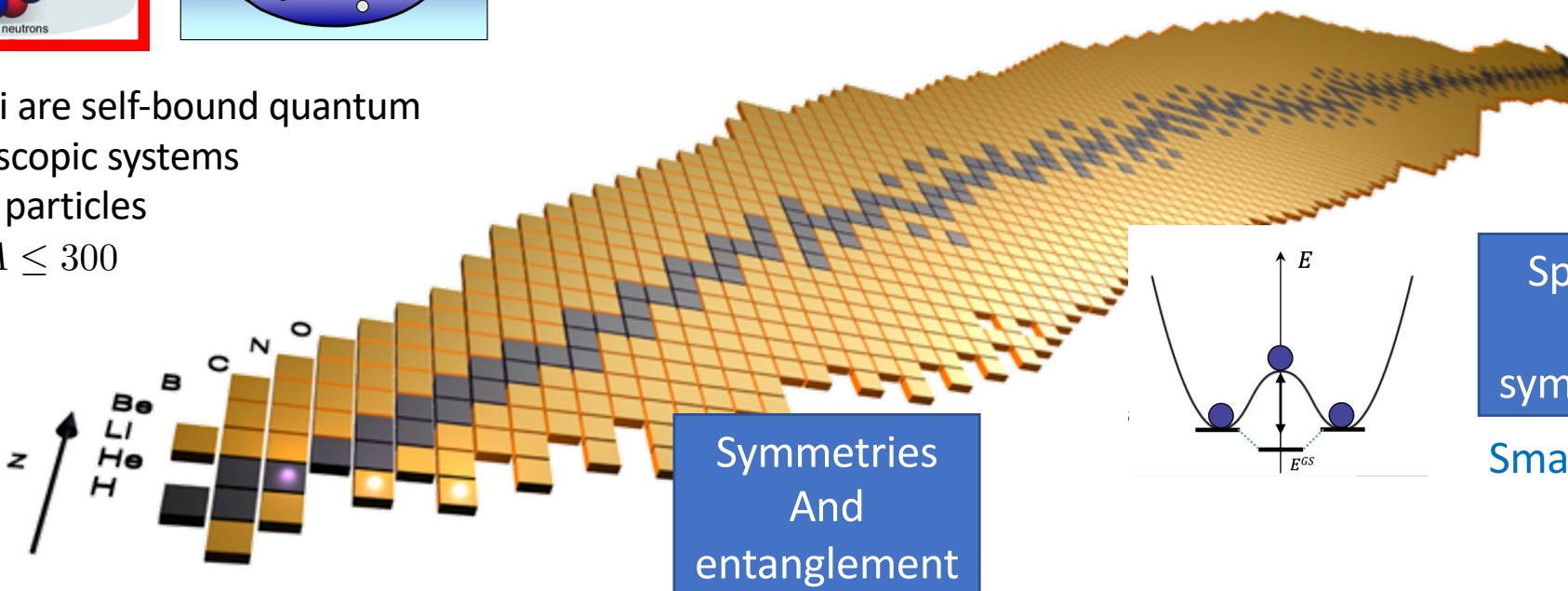

Spontaneous Broken symmetries (SB)

Small superfluid

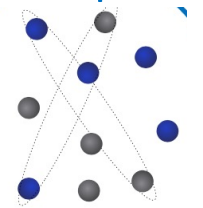

(particle number SB)

Interaction

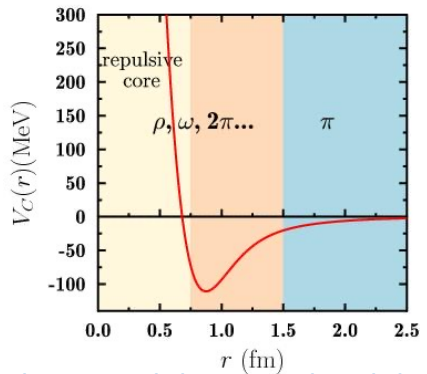

The problem is highly non-perturbative

Global symmetries induce All-to-all entanglement

$$S, T, J, \pi$$

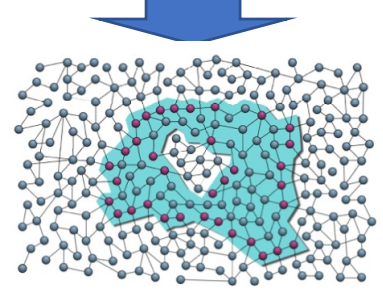

Nuclei are subject to entanglement volume law (bad candidate for Tensor Network)

Deformation can happen

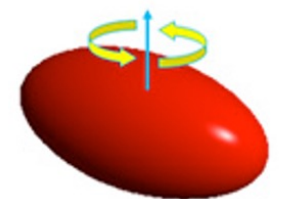

(rotational invariance SB)

...

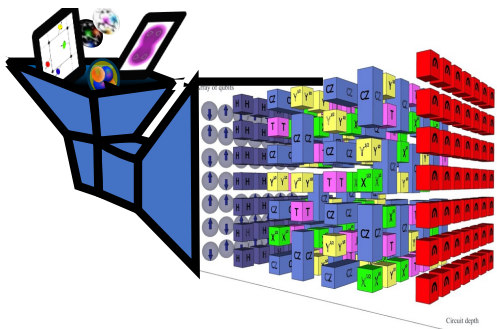

Developing variational approaches based on symmetry-breaking (SB)/symmetry restoration (SR)

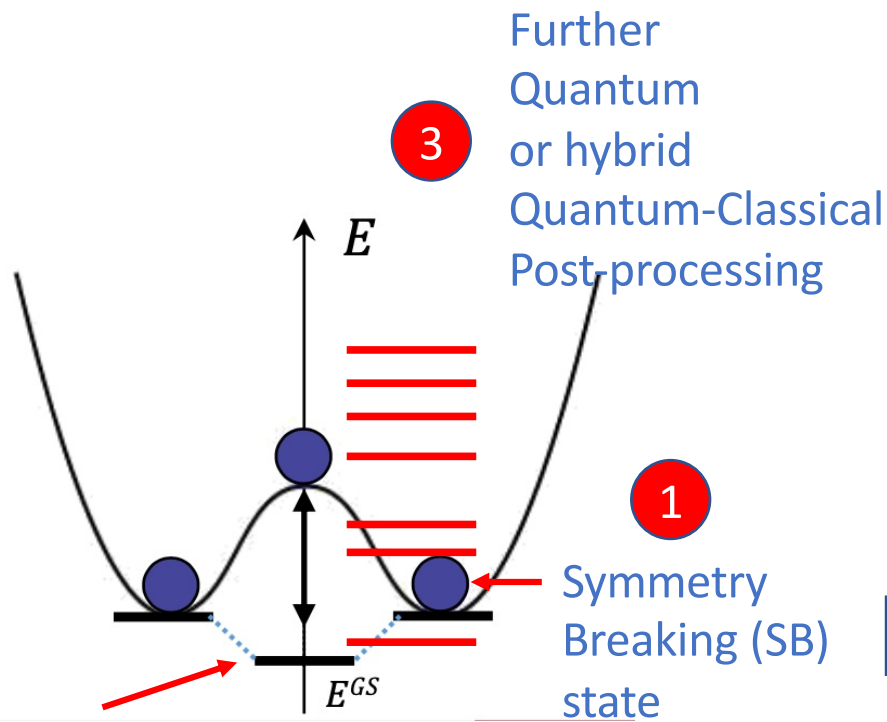
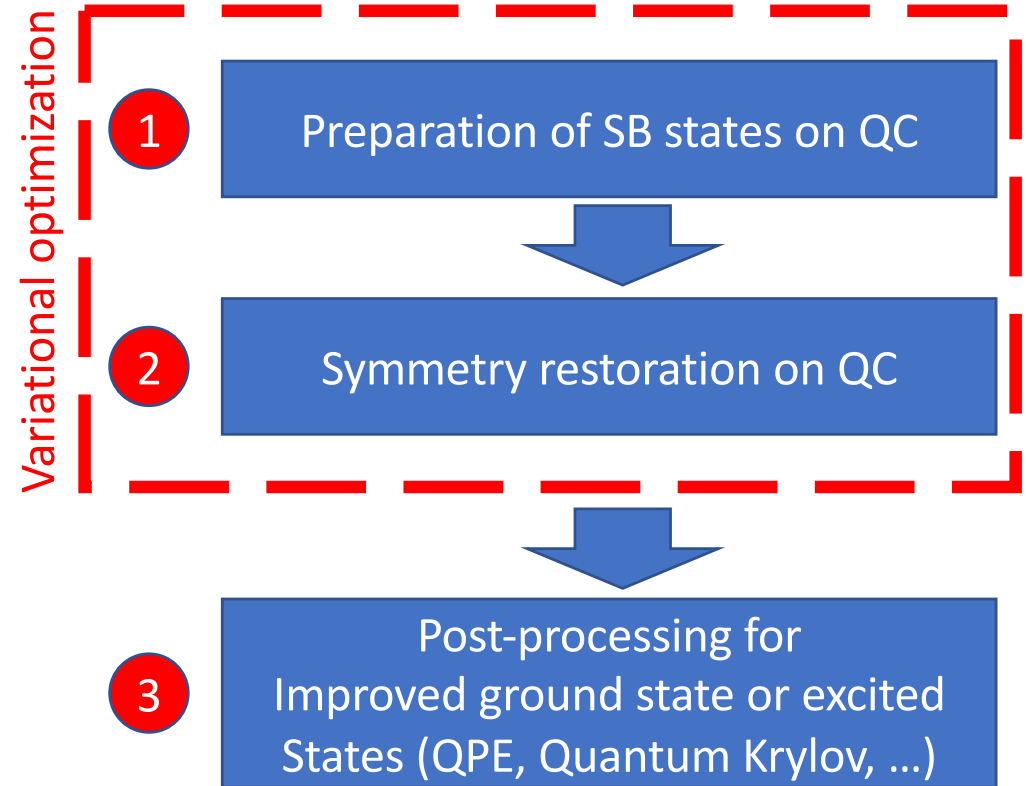

Which symmetries ?

Many-Body
Particle Number
Parity
Total Spin

Quantum computing
Hamming weight
Odd/Even number of 1
Permutation Invariance

2 Symmetry Restored (SR) state (multi-reference)

D. Lacroix, A. Ruiz Guzman and P. Siwach,
Symmetry breaking/symmetry preserving circuits
and symmetry restoration on quantum computers
EPJA 59 (2023)

Illustration with small superconductors

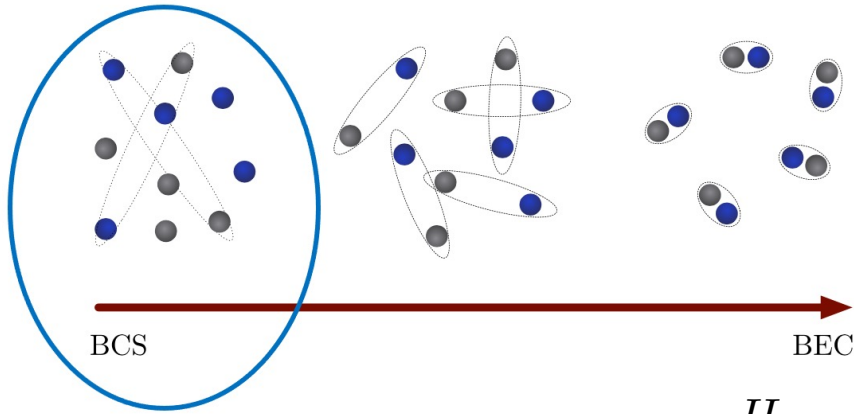
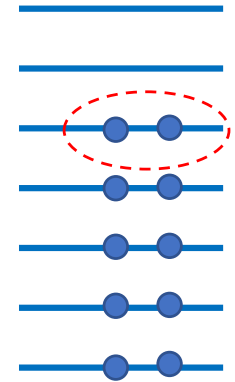

Illustration with the Richardson Hamiltonian

$$H_P = \sum_{i>0} \varepsilon_i (a_i^\dagger a_i + a_{\bar{i}}^\dagger a_{\bar{i}}) - g \sum_{i,j>0} a_i^\dagger a_{\bar{i}}^\dagger a_{\bar{j}} a_j$$



This problem is an archetype of spontaneous symmetry breaking. An “easy” way to describe it is to break the particle number symmetry, i.e. consider wave-function that mixes different particle number

Example

$$|\Phi_0\rangle = \prod_i (u_i + v_i a_i^\dagger a_{\bar{i}}^\dagger) |-\rangle$$

➔ Mixes states with 0, 2, 4, ... particles

The particle number - U(1) symmetry) is broken

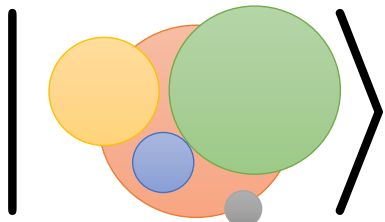

But ultimately number of Particle should be restored !

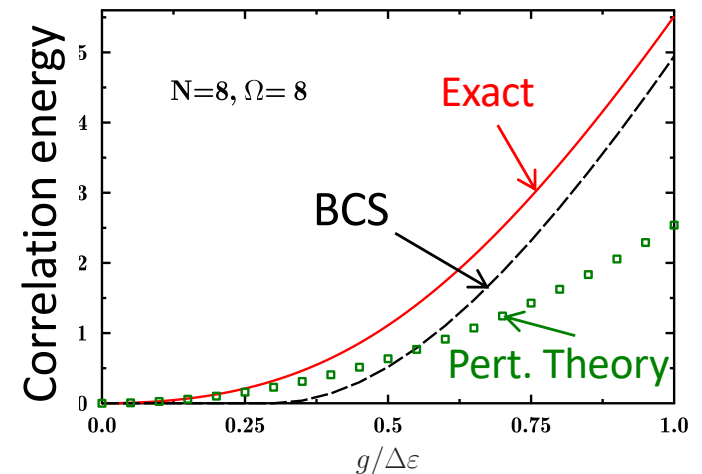

Application to the N-body pairing problem

Hamiltonian and initial state

Pairing Hamiltonian

$$H_P = \sum_{i>0} \varepsilon_i (a_i^\dagger a_i + a_{\bar{i}}^\dagger a_{\bar{i}}) - g \sum_{i,j>0} a_i^\dagger a_{\bar{i}}^\dagger a_{\bar{j}} a_j$$

Jordan-Wigner transfo: $\frac{1}{2}(I_i - Z_i)$

State ordering is important !

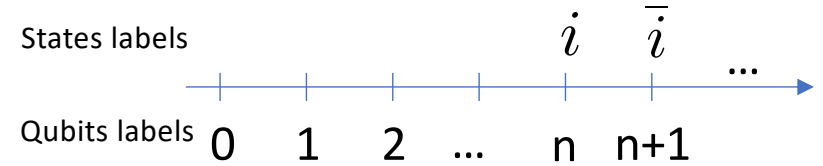

$$a_i^\dagger a_{\bar{i}}^\dagger \longrightarrow Q_n^+ Q_{n+1}^+$$

Initial (symmetry breaking) state preparation

$$|\Psi\rangle = \exp \left\{ - \sum_{i>0} \varphi_i (a_i^\dagger a_{\bar{i}}^\dagger - a_{\bar{i}} a_i) \right\} |0\rangle \quad \varphi_i = \varphi \longrightarrow |\Psi\rangle = \prod_{n>0} e^{i\varphi(X_n Y_{n+1} + Y_n X_{n+1})/2} |-\rangle$$

Equivalent universal gate on pairs

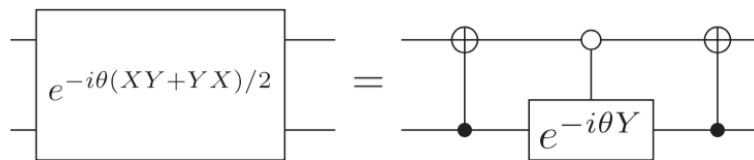

Simplified circuit (generalized Bell state)

$$|\Psi\rangle = \prod_n \left[\cos\left(\frac{\varphi}{2}\right) I_n \otimes I_{n+1} + \sin\left(\frac{\varphi}{2}\right) Q_n^+ Q_{n+1}^+ \right] |-\rangle$$

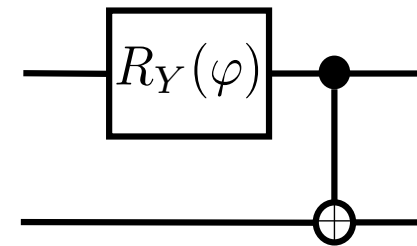

Zhang Jiang et al,
Phys. Rev. Applied 9, 044036 (2018).

Quantum computing for atomic nuclei

Illustration for small superfluids

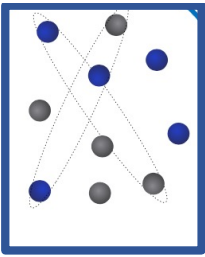

Superfluidity can be described by breaking particle number

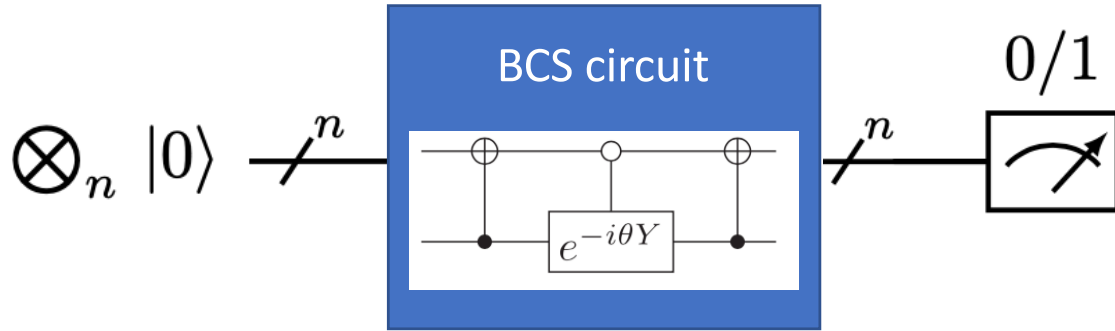

Example of mixing for 12 qubits (with qiskit)

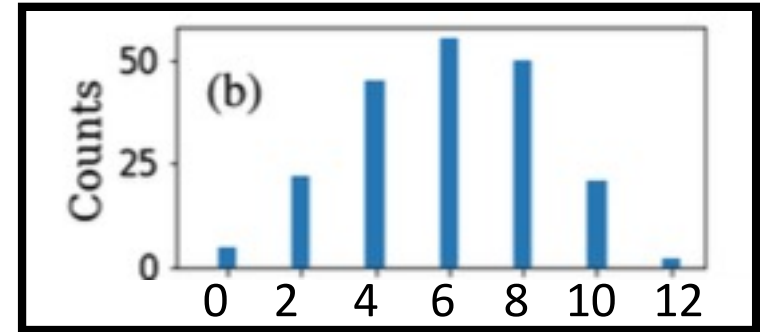

Projection on particle number

$$|\Psi\rangle = \sum_N c_N |N\rangle \rightarrow |N\rangle$$

For 2 qubits

$$|\Psi\rangle = \alpha |00\rangle + \beta |01\rangle + \gamma |10\rangle + \delta |11\rangle$$

$|N=0\rangle$
 $\propto |N=1\rangle$
 $|N=2\rangle$

➔ A possible way to perform the projection is to use The Quantum-Phase-Estimation method with N itself

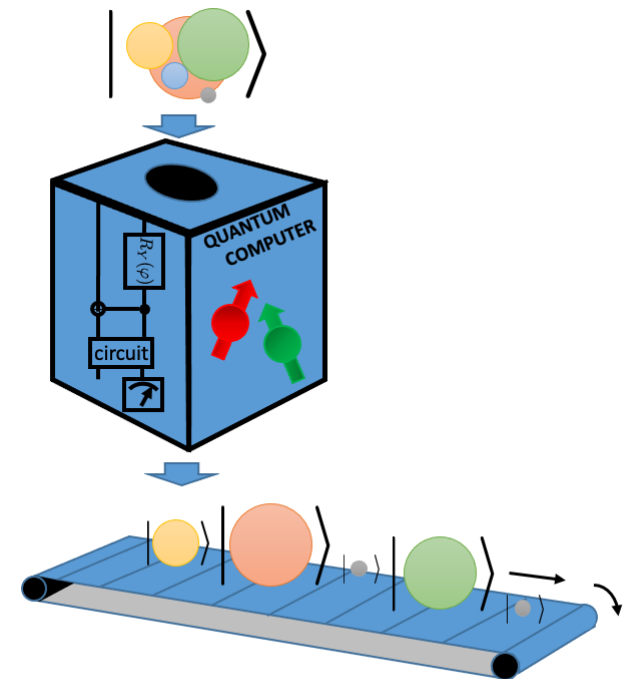

Non-destructive counting on a quantum computer

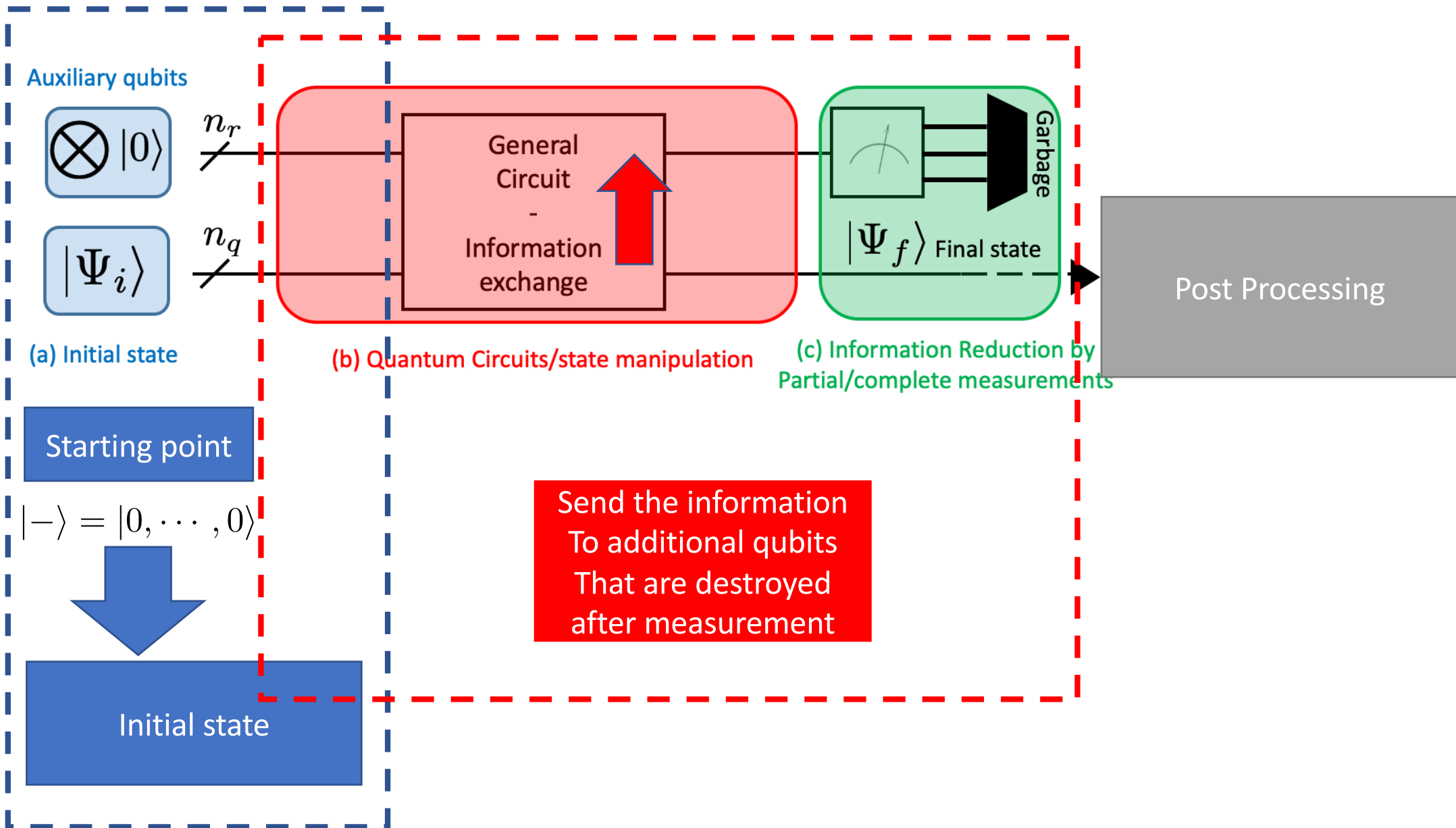

The quantum-Phase estimation (QPE) algorithm

For known eigenvalue problems

Assume a unitary operator U

Assume an eigenstate $|\Psi\rangle$ Such that $U|\Psi\rangle = e^{2\pi i\varphi}|\Psi\rangle$

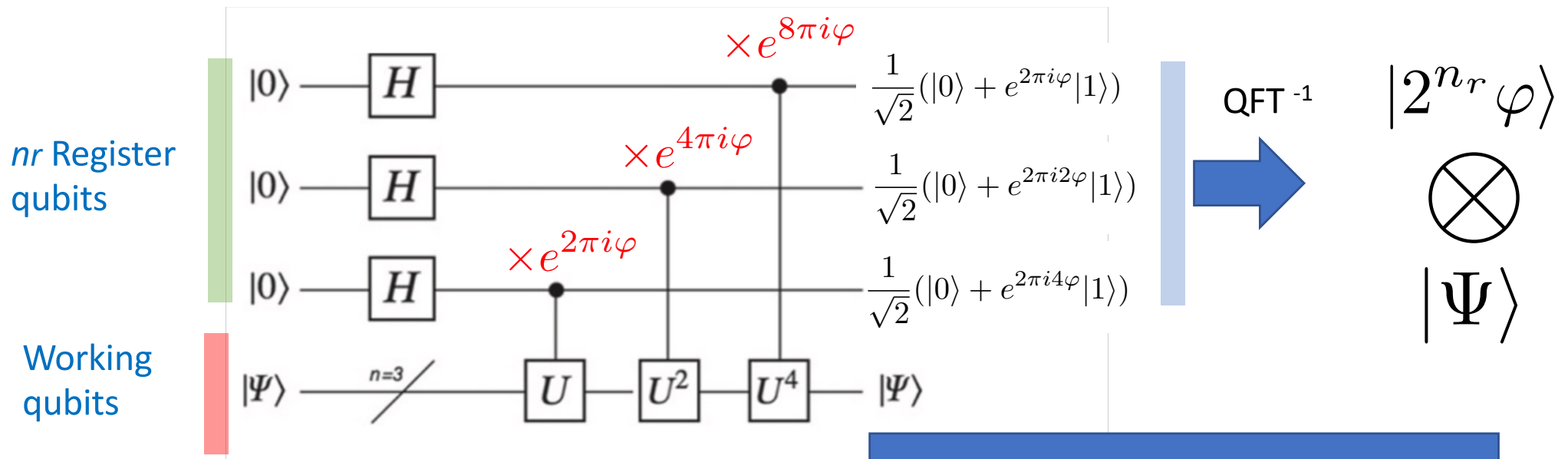

For the particle number projection

General Case

$$|\Psi\rangle = \sum_k \alpha_k |\phi_k\rangle \xrightarrow{\text{QPE}} \sum_k \alpha_k \underbrace{|\theta_k 2^{n_r}\rangle}_{\text{register}} \otimes \underbrace{|\phi_k\rangle}_{\text{eigenstate}}$$

$$U = U_N = e^{2\pi i \frac{N}{2^{n_r}}} \text{ with } N = \frac{1}{2} \sum_i (I_i - Z_i)$$

Assume eigenvalues $\{0, 1, \dots, A\}$

Constraint: $0 \leq \frac{A}{2^{n_r}} < 1$ then $\frac{A}{2^{n_r}} = 0.a_1 \dots a_{n_r-1}$

If I measure given binary number in the ancillary qubit. After measurement, I have the projection on the associated particle number component

Eigenvalues-Ground state and excited states

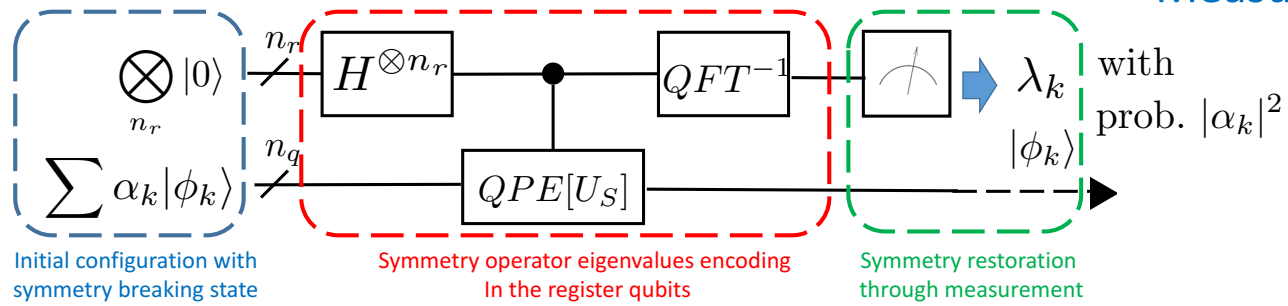

Example of an event:

$$|011 \dots 010\rangle^{(\lambda)} \otimes |\phi_{A^{(\lambda)}}\rangle = A^{(\lambda)}$$

BCS/HFB state

$$|\Psi\rangle = \prod_n \left[\cos\left(\frac{\varphi}{2}\right) I_n \otimes I_{n+1} + \sin\left(\frac{\varphi}{2}\right) Q_n^+ Q_{n+1}^+ \right] |-\rangle$$

Measurement

Projected BCS or with varying number of particles

Degenerate case

$$H_P = -g \sum_{i,j>0} a_i^\dagger a_i^\dagger a_j^- a_j$$

$$\langle \phi_{A^{(\lambda)}} | H | \phi_{A^{(\lambda)}} \rangle$$

H was encoded on the full Fock space with $A < n_q$
For the degenerate case, this should give the exact solution

6 pairs

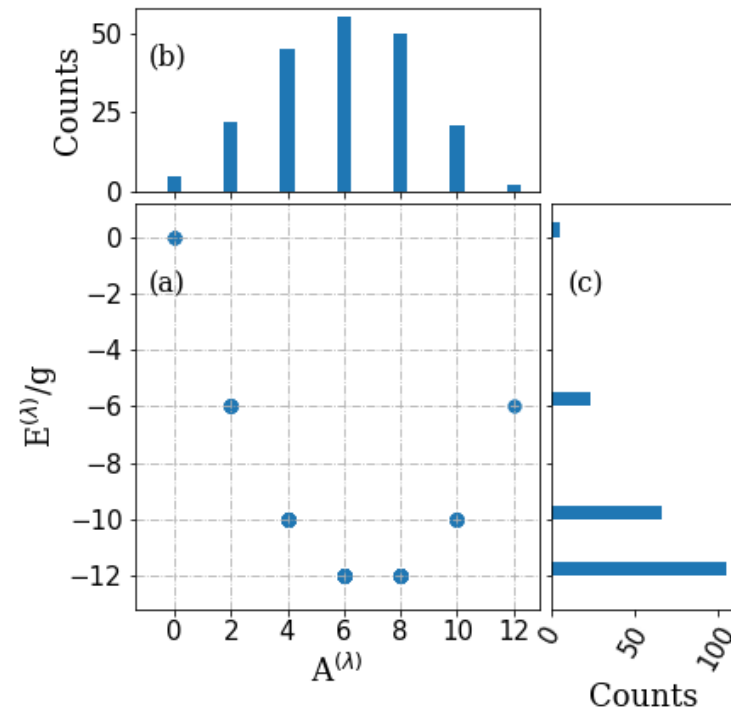

Exact solution

$$E/g = -\frac{1}{4}(A - \nu)(2n_q - A - \nu - 2).$$

More on symmetry restoration techniques on quantum computer

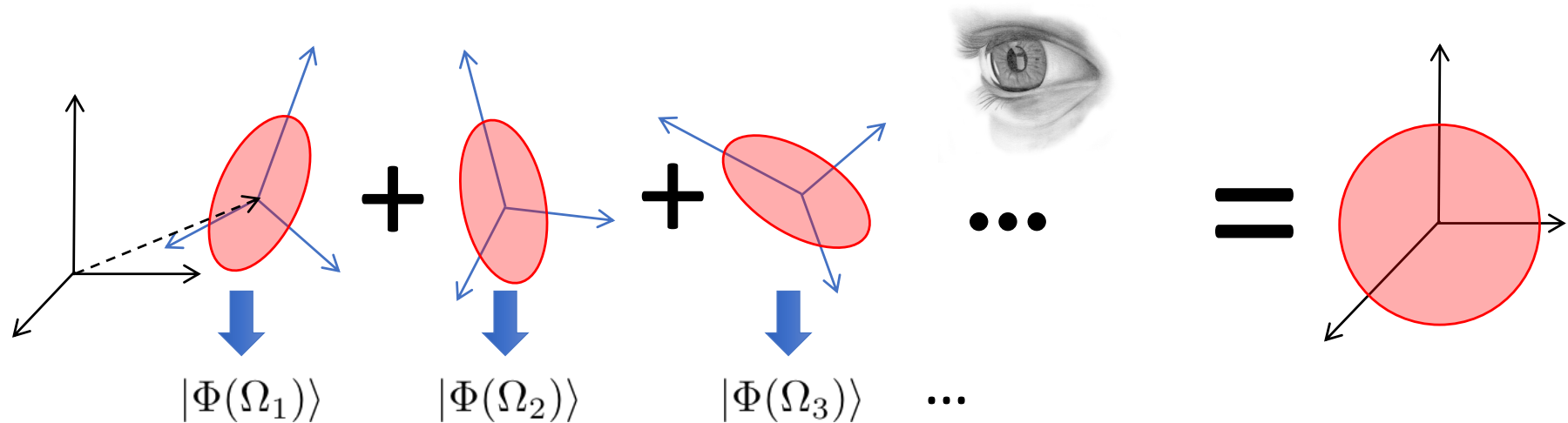

Exploration of different methods for the symmetry restoration

Complete Hilbert space

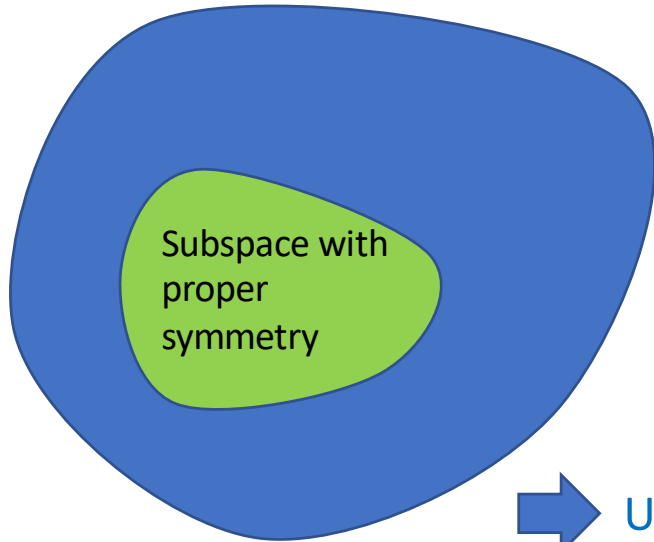

Systematic Exploration of Phase-Estimation based methods for symmetry restoration (Kitaev method, Rodeo algorithms)

Eur. Phys. J. A (2023) 59:3
<https://doi.org/10.1140/epja/s10050-022-00911-7>

THE EUROPEAN
 PHYSICAL JOURNAL A



Regular Article - Theoretical Physics

Symmetry breaking/symmetry preserving circuits and symmetry restoration on quantum computers

A quantum many-body perspective

Denis Lacroix^{1,a}, Edgar Andres Ruiz Guzman^{1,b}, Pooja Siwach^{2,c}



Use Oracle's and Grover-based methods for projection onto a subspace
 Grover and Oracle

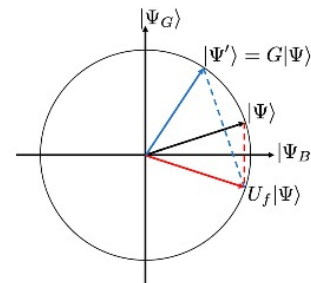

Linear Combination of Unitaries

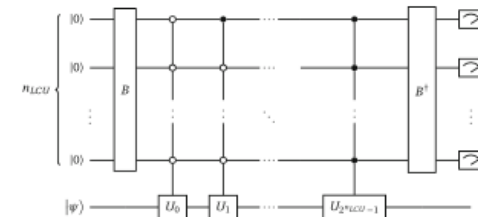

Use quantum tomography techniques
 (Classical Shadow method)

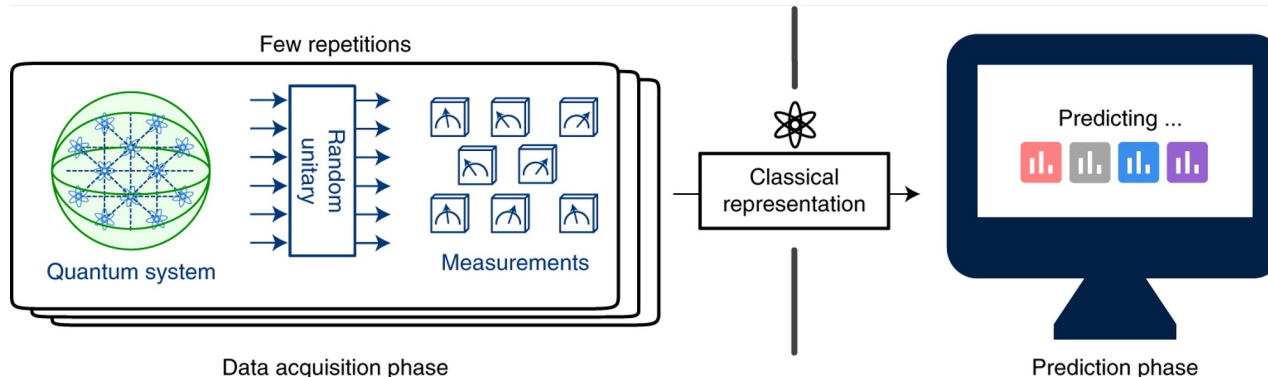

Restoring broken symmetries using quantum search "oracles"

Edgar Andres Ruiz Guzman and Denis Lacroix
 Phys. Rev. C **107**, 034310 (2023) - Published 16 March 2023

Standard Quantum Phase estimation

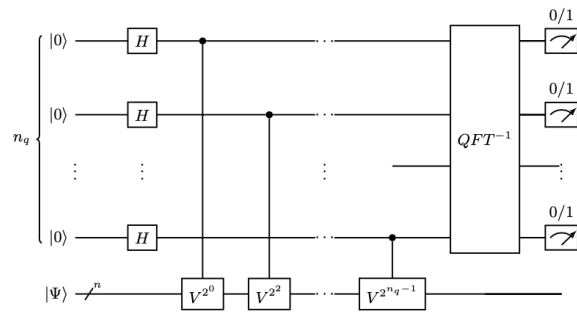

Iterative Quantum Phase estimation

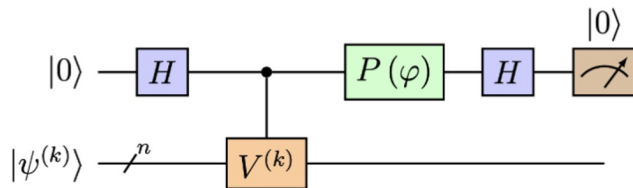

$$\hat{V}^{(k)} = e^{i\phi_k \hat{N}} ; \quad \phi_k = \frac{\pi}{2^k}$$

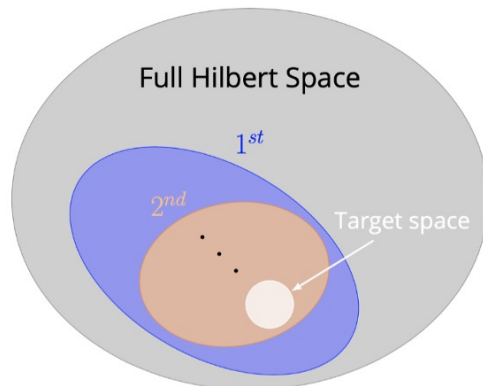

16 qubits, N = 8

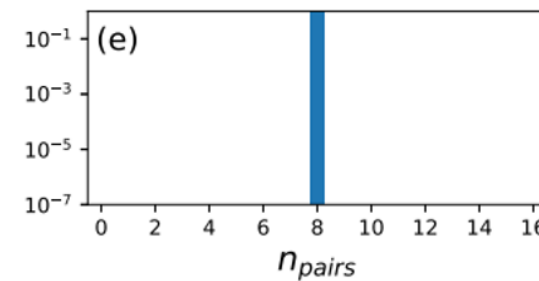
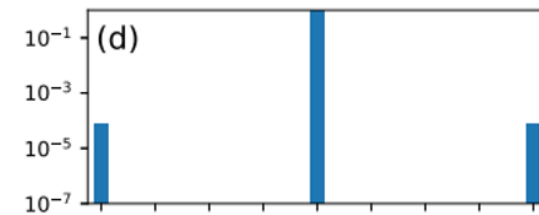
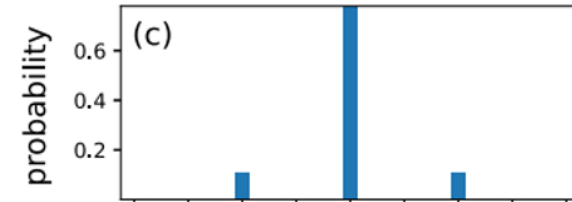
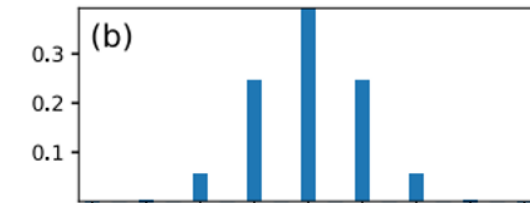
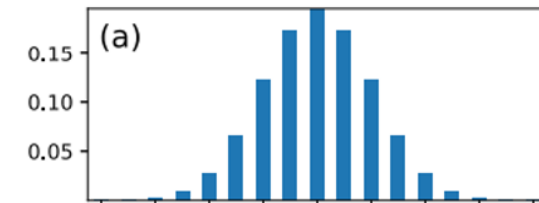

Systematic of QPE-based methods

Standard Quantum Phase estimation

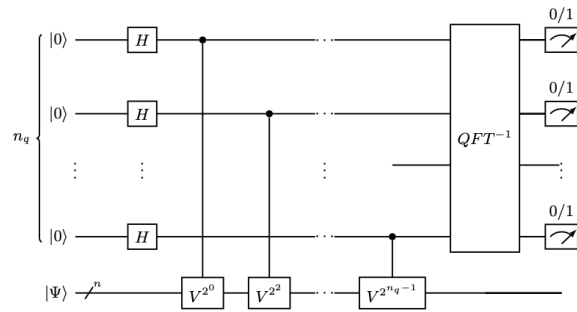

Iterative Quantum Phase estimation + random Gaussian time (Rodeo algorithm)

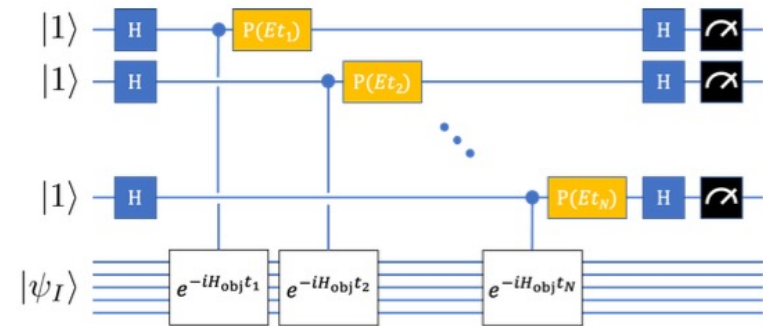

Iterative Quantum Phase estimation

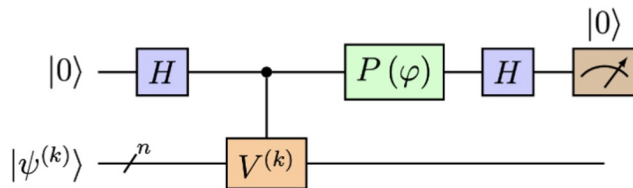

$$\hat{V}^{(k)} = e^{i\phi_k \hat{N}} \quad \phi_k = \frac{\pi}{2^k}$$

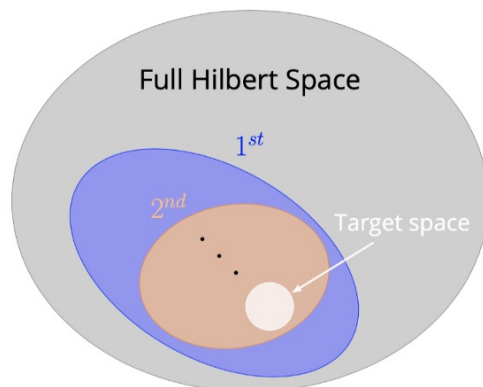

K. Choi et al., Rodeo Algorithm for Quantum Computing, Phys. Rev. Lett. 127, 040505 (2021).

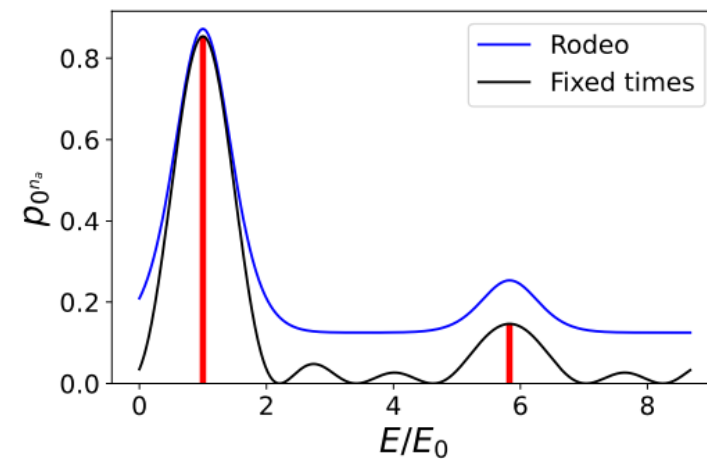

Ayral, Besserve, Lacroix, Ruiz Guzman, EPJA 59 (2023)

Standard Quantum Phase estimation

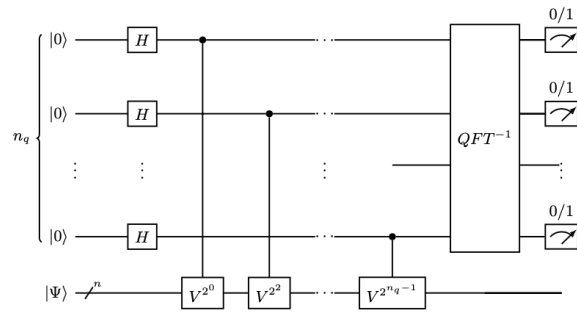

Iterative Quantum Phase estimation + random Gaussian time (Rodeo algorithm)

Iterative Quantum Phase estimation

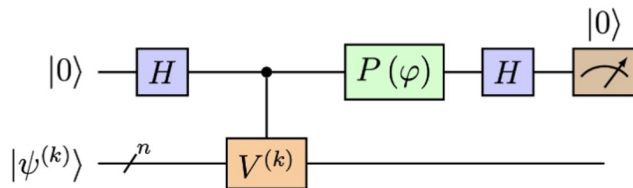

$$\hat{V}^{(k)} = e^{i\phi_k \hat{N}} \quad ; \quad \phi_k = \frac{\pi}{2^k}$$

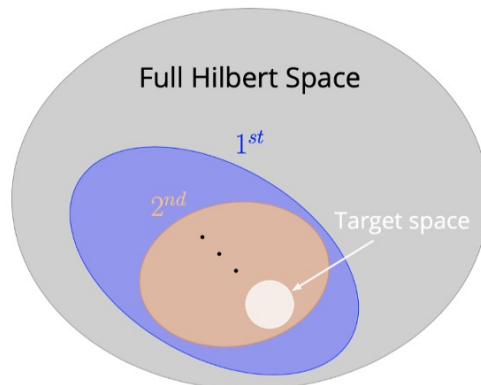

Iterative QPE Rodeo algorithm with different resolution

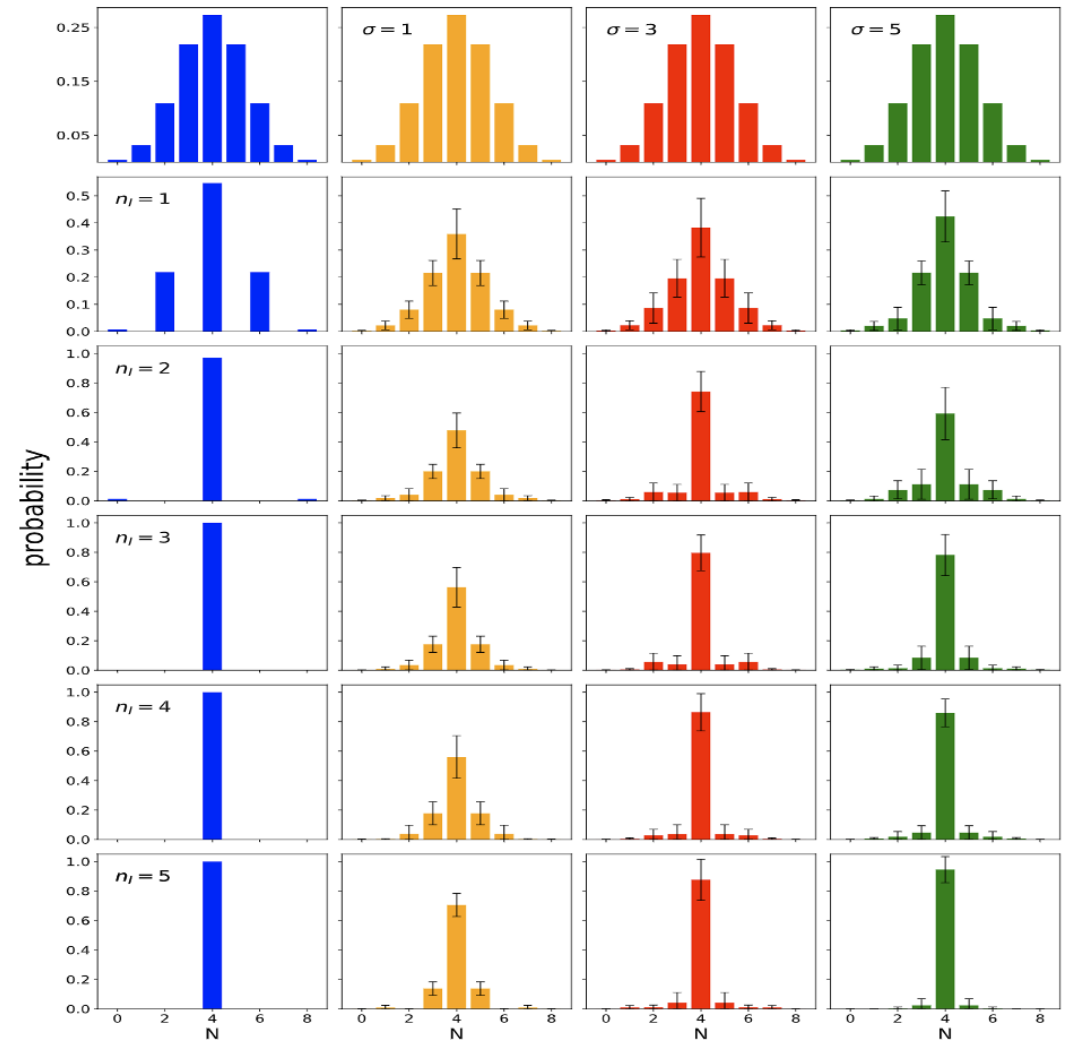

Symmetry restoration using Projection operators and Oracles

Grover Classification operator

$$\hat{U}_f |k\rangle = (-1)^x \text{ with } x \begin{cases} 0 & \text{if } |k\rangle \in \bar{\Omega} \\ 1 & \text{if } |k\rangle \in \Omega \end{cases}$$

Lov K. Grover, Phys. Rev. Lett. **79**, 325 (1997)

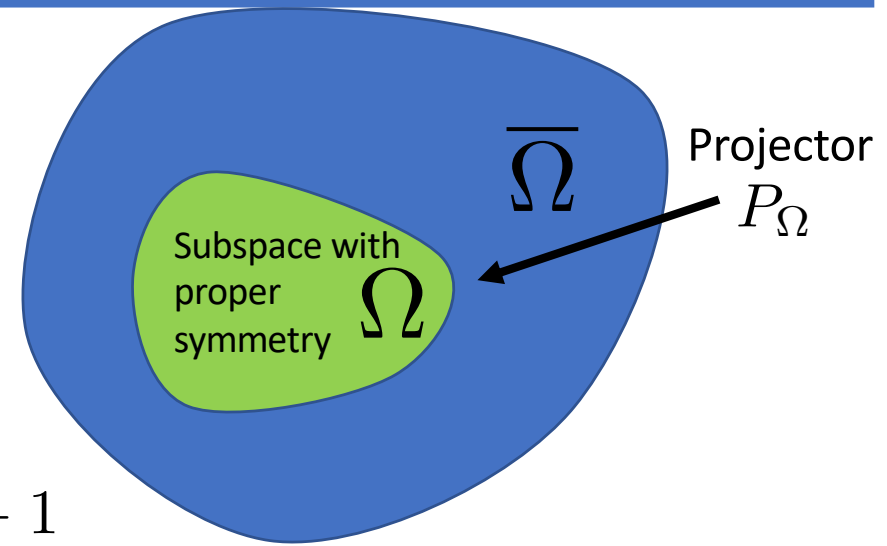

Assume we are able to encode the projector

$$P_\Omega \rightarrow U_f = +1P_\Omega - 1(1 - P_\Omega) = 2P_\Omega - 1$$

Methods based on projectors

Oracle + Hadamard test

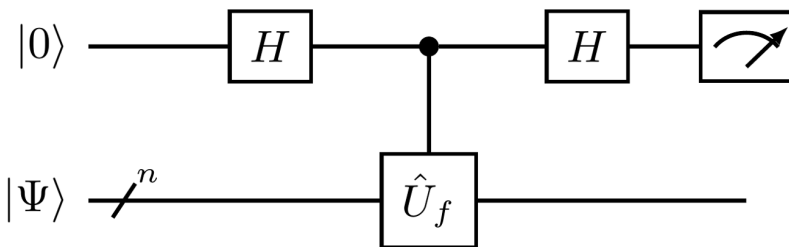

$$\frac{1}{2} \{ |0\rangle \otimes [I + \hat{U}_f] |\Psi\rangle + |1\rangle \otimes [I - \hat{U}_f] |\Psi\rangle \} = |0\rangle |\Psi_B\rangle + |1\rangle |\Psi_G\rangle$$

Grover technique

Amplitude Amplification

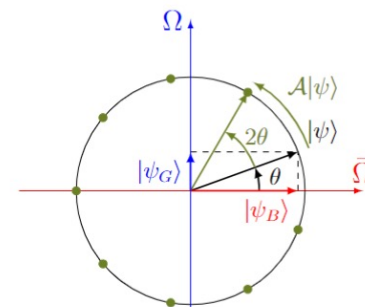

Grover-Hoyer

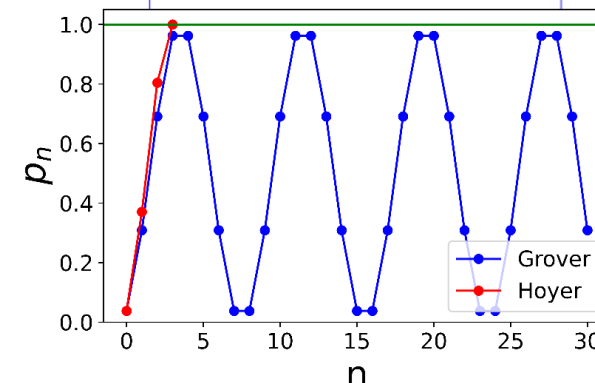
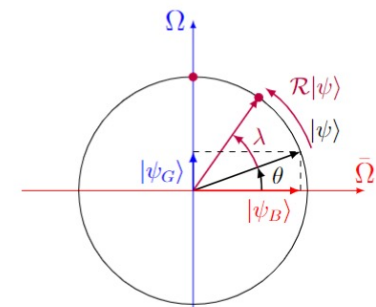

Symmetry restoration using Projection operators and Oracles

Grover Classification operator

$$\hat{U}_f |k\rangle = (-1)^x \text{ with } x \begin{cases} 0 & \text{if } |k\rangle \in \bar{\Omega} \\ 1 & \text{if } |k\rangle \in \Omega \end{cases}$$

Lov K. Grover, Phys. Rev. Lett. **79**, 325 (1997)

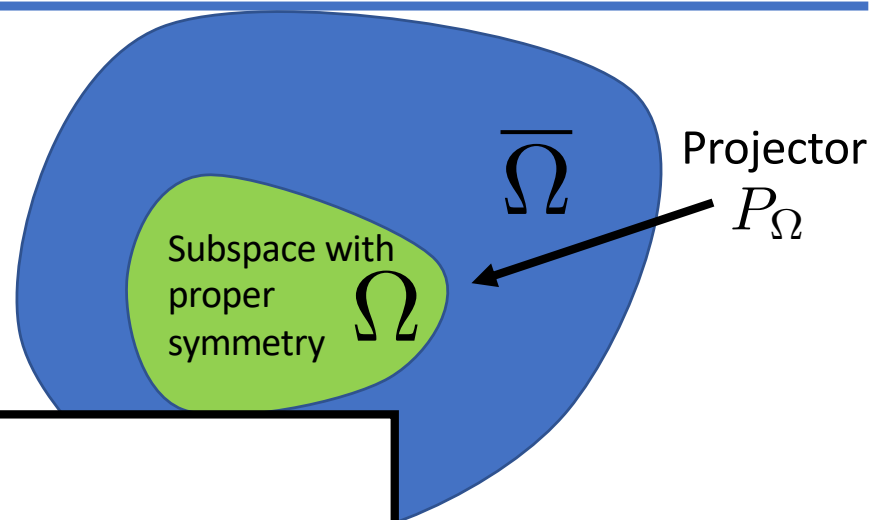

Assume w

Practical implementation of projectors

P_Ω

$$P_N = \frac{1}{n+1} \sum_{k=0}^n e^{\frac{2\pi i k (\hat{N} - N)}{n+1}} = \text{sum of unitary operators}$$

Methods

Oracle + H

$|0\rangle$

$|\Psi\rangle$

$\frac{1}{2} \{|0\rangle \otimes [I + U]$

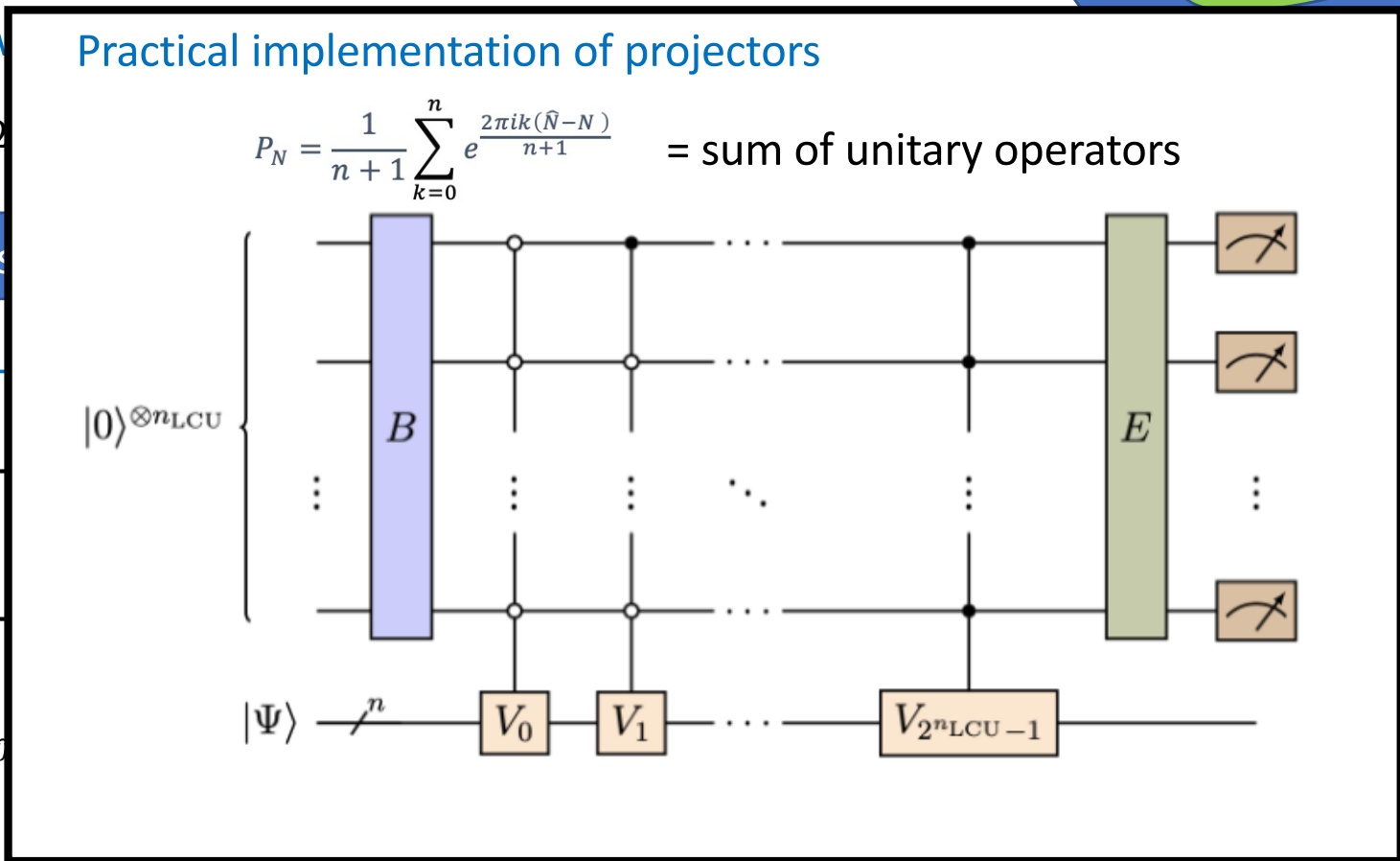

Grover-Hoyer

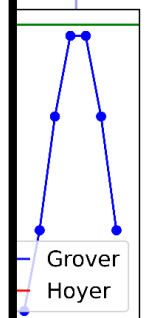
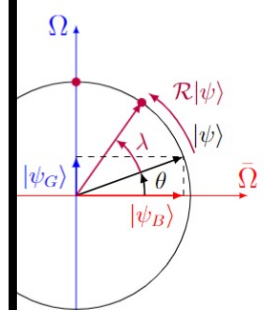

0 5 10 15 20 25 30
n

Symmetry restoration by quantum tomography

Classical shadow technique

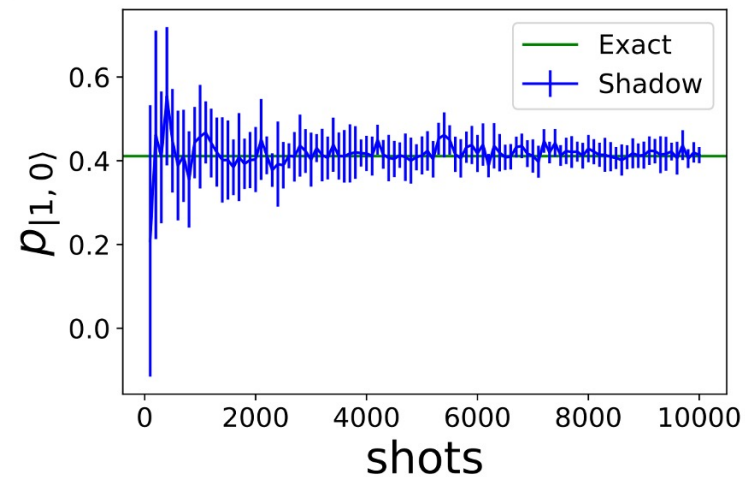
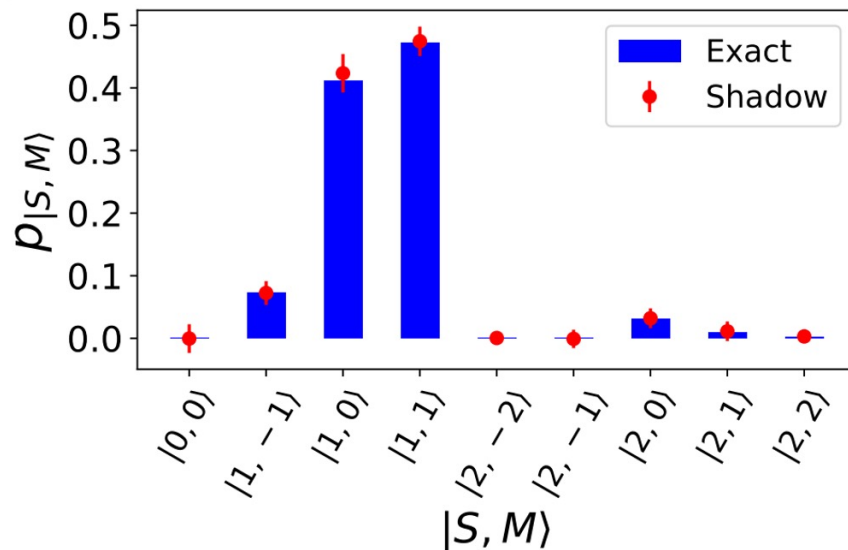
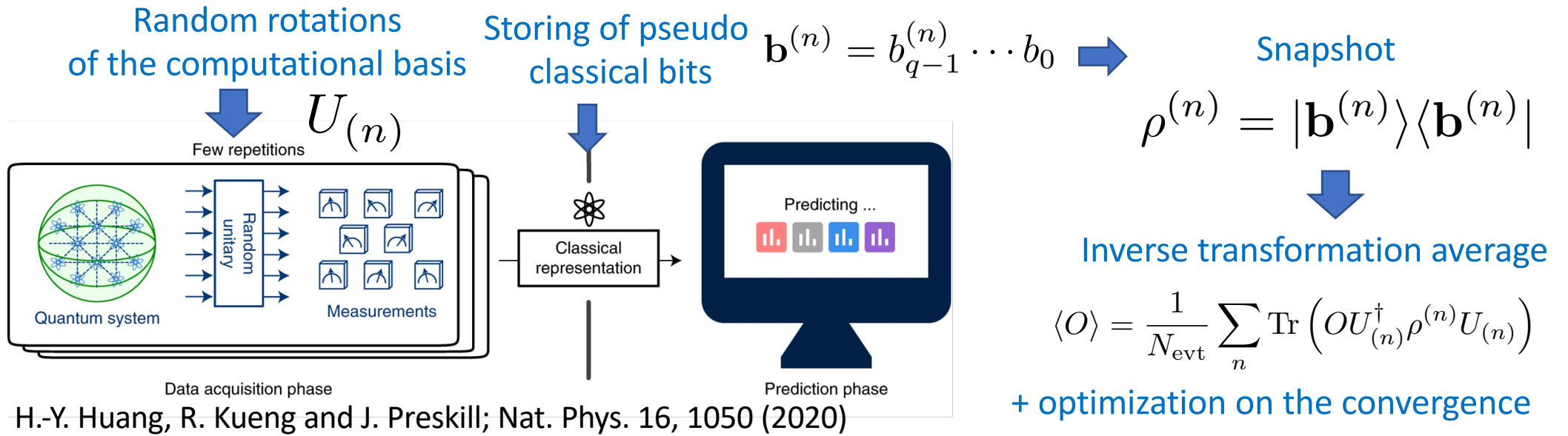

Coming back to our superconducting problem

Combining projection with variational method

Possible optimization schemes

Variational

Symmetry-Breaking ansatz $|\Psi(\{\theta_p\})\rangle = \bigotimes_{p=1}^{N-1} [\sin(\theta_p)|0_p\rangle + \cos(\theta_p)|1_p\rangle]$

Pair occupation are now encoded

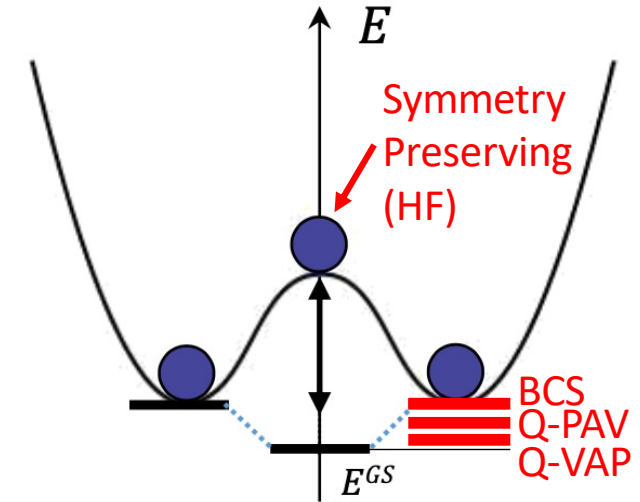

Quantum-Classical optimizers

→ Standard BCS theory

→ Project after optimization
Q-PAV: Quantum Projection After Variation

→ The optimization is made on the Symmetry restored state.
Q-VAP: Quantum Variation After Projection

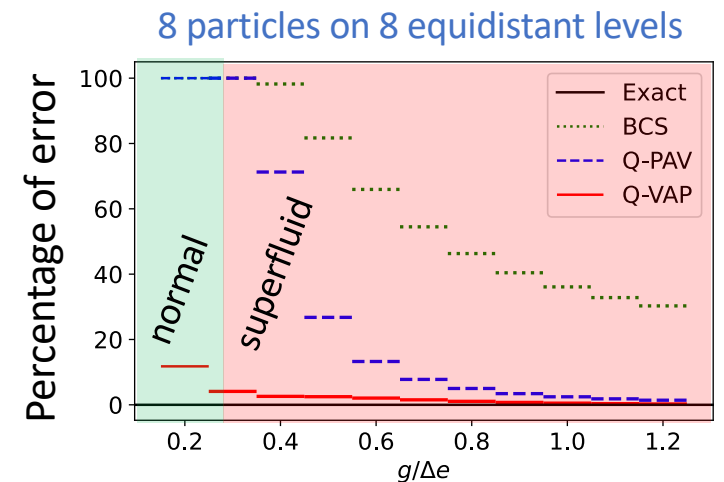
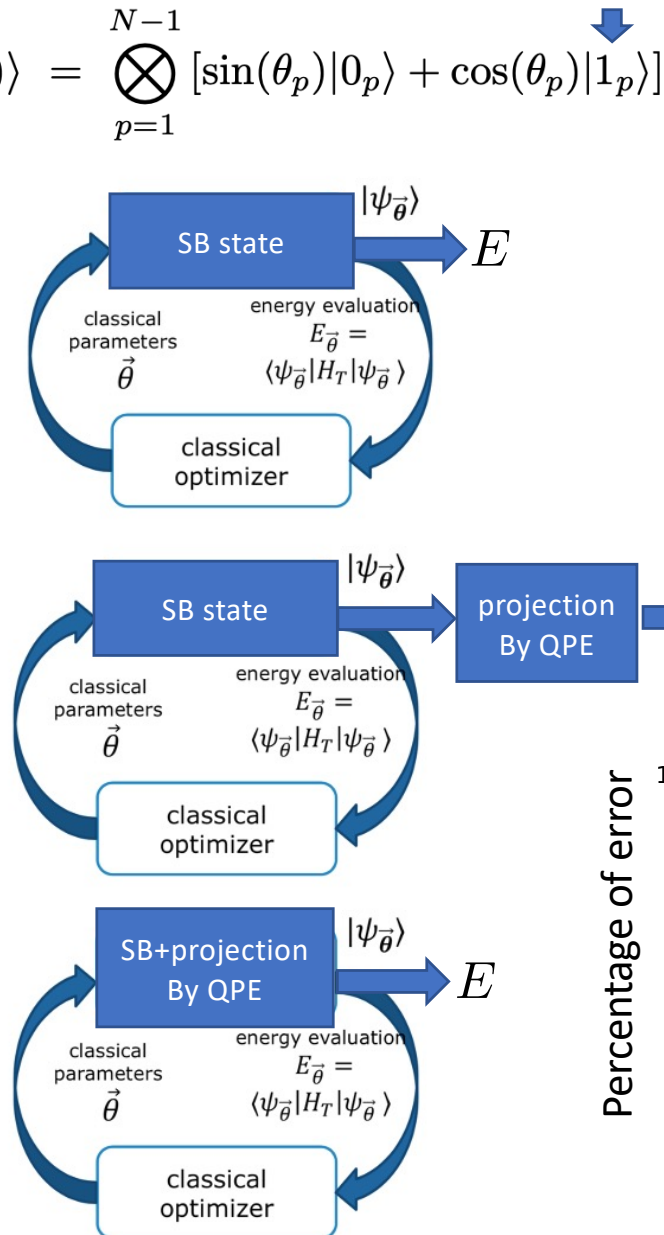

Is the breaking of symmetries always a good idea?

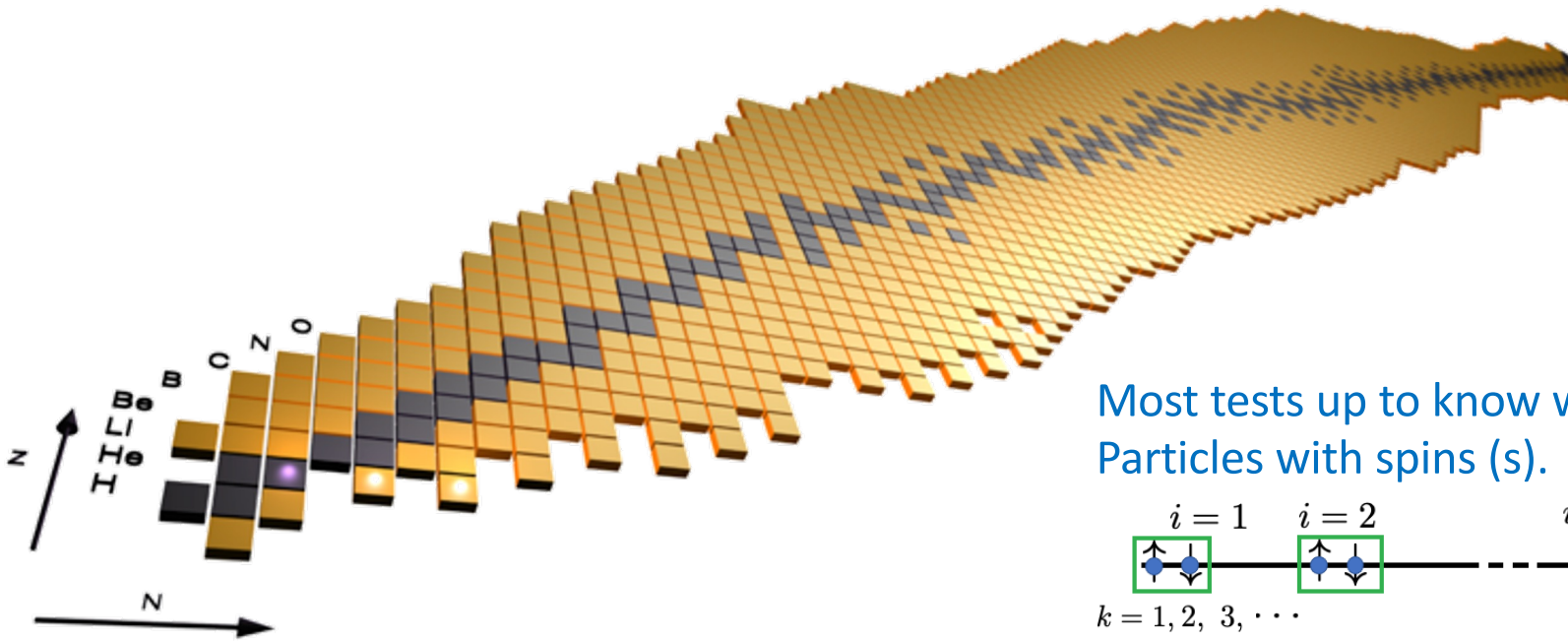

Most tests up to know were made on Particles with spins (s).

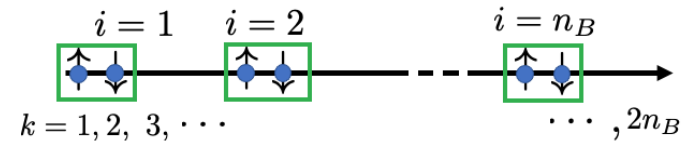

But nuclei have both spin (s) and isospin (t) (neutron/proton)

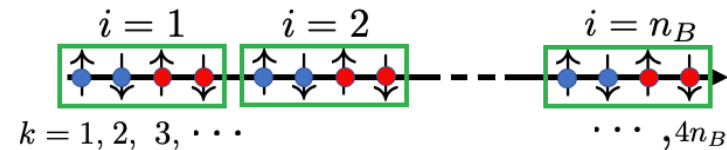

➡ This increases the number of qubits

$$S_z, S^2, \pi$$

➡ This increases the number of symmetries that could be broken

$$S_z, S^2, T_z, T^2, \pi$$

Symmetry-breaking states become extremely hard to control
Symmetry restoration becomes very demanding

Iterative construction of the ansatz

Grimsley, et al, Nat. Commun. 10 (2019)

➔ Start from a state $|\Psi_0\rangle = |n = 0\rangle$

➔ Built iteratively the ansatz such as:

$$|n\rangle = e^{i\theta_n A_n} |n-1\rangle = \prod_{k=1}^n e^{i\theta_k A_k} |0\rangle$$

Such that $A_n \in \{O_1, \dots, O_\Omega\}$

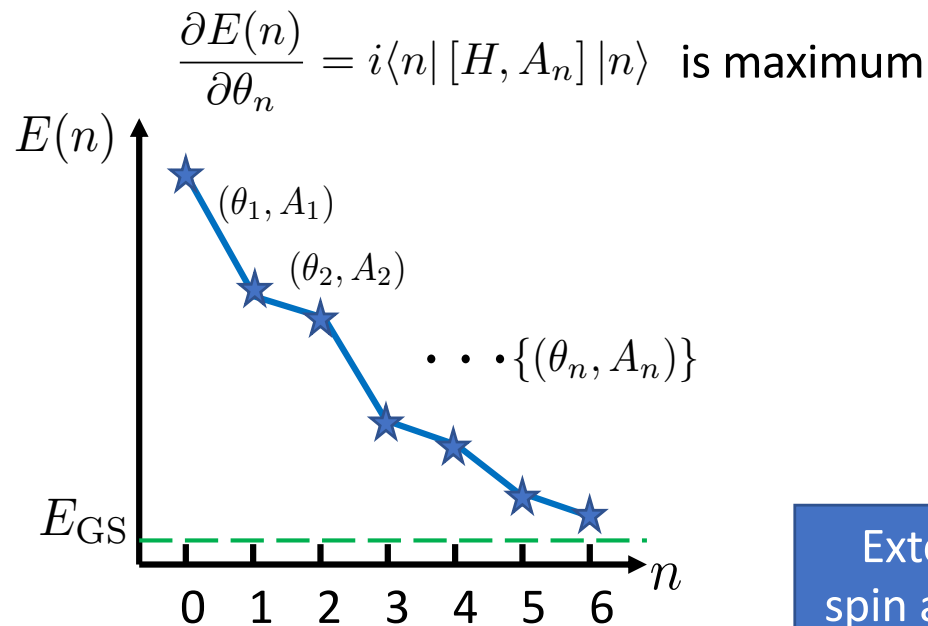

ADAPT-VQE applied to the Superfluid problems: only spins

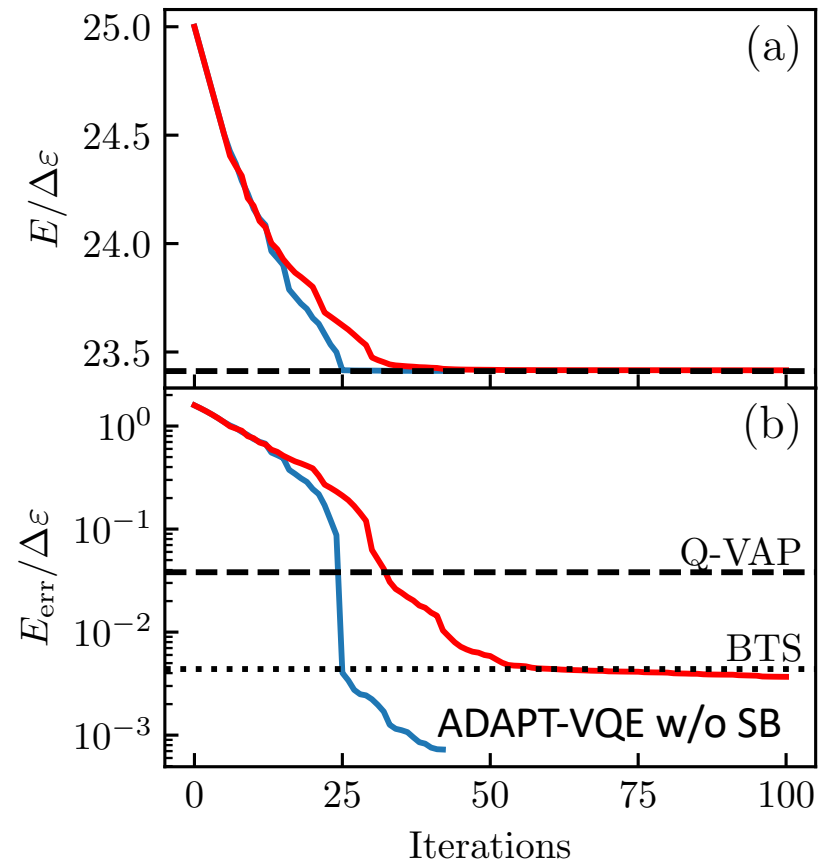

J. Zhang, D. Lacroix, and Y. Beaujeault-Taudière, arXiv:2408.17294

Extension to spin and isospin

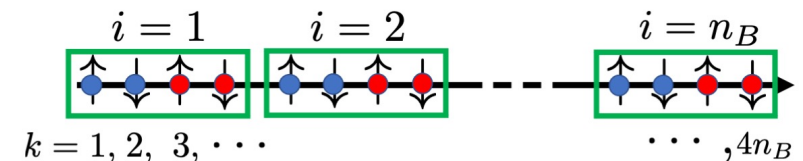

Is breaking symmetries always a good idea?

Extension to the proton-neutron pairing Hamiltonian problem

$$\begin{aligned}
 H = & \sum_{i=1}^{n_B} \left[\varepsilon_{i,n} (\nu_i^\dagger \nu_i + \nu_{\bar{i}}^\dagger \nu_{\bar{i}}) + \varepsilon_{i,p} (\pi_i^\dagger \pi_i + \pi_{\bar{i}}^\dagger \pi_{\bar{i}}) \right] \\
 - & \sum_{T_z=-1,0,1} g_V(T_z) \mathcal{P}_{T_z}^\dagger \mathcal{P}_{T_z} \\
 - & \sum_{S_z=-1,0,1} g_S(S_z) \mathcal{D}_{S_z}^\dagger \mathcal{D}_{S_z}.
 \end{aligned}$$

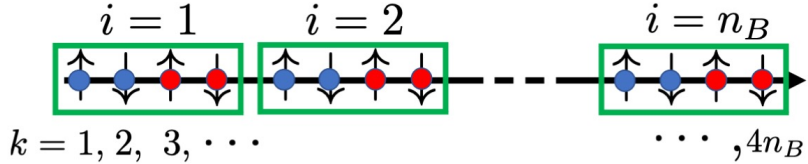

Different Hamiltonian limit

Case	S_z/T_z	Isoscalar			Isovector		
		-1	0	1	-1	0	1
1					✓	✓	
2			✓		✓	✓	
3					✓	✓	
4		✓	✓	✓	✓	✓	

Different operator pool in ADAPT-VQE breaking or not symmetries

	Particle number	Seniority	Parity
H-pool	✓	✓	✓
QEB-pool	✓	×	✓
Qubit-pool	×	×	✓

4 particles on 8 qubits

Degenerate

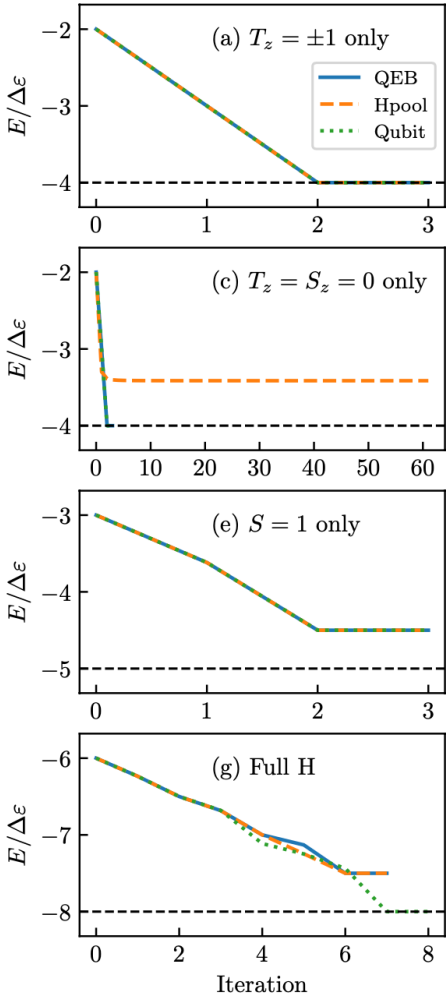

4 particles on 12 qubits

Degenerate

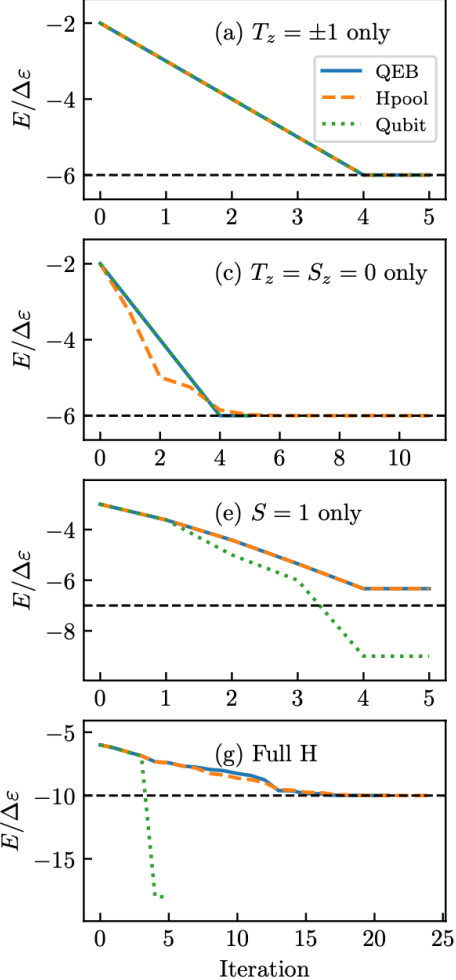

Is breaking symmetries always a good idea?

Extension to the proton-neutron pairing Hamiltonian problem

$$\begin{aligned}
 H = & \sum_{i=1}^{n_B} \left[\varepsilon_{i,n} (\nu_i^\dagger \nu_i + \nu_{\bar{i}}^\dagger \nu_{\bar{i}}) + \varepsilon_{i,p} (\pi_i^\dagger \pi_i + \pi_{\bar{i}}^\dagger \pi_{\bar{i}}) \right] \\
 & - \sum_{T_z=-1,0,1} g_V(T_z) \mathcal{P}_{T_z}^\dagger \mathcal{P}_{T_z} \\
 & - \sum_{S_z=-1,0,1} g_S(S_z) \mathcal{D}_{S_z}^\dagger \mathcal{D}_{S_z}.
 \end{aligned}$$

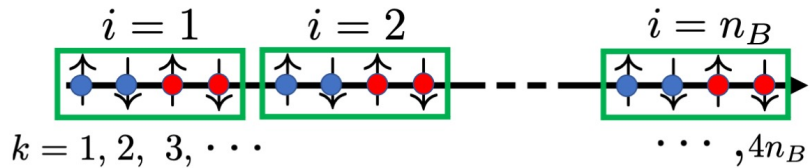

4 particles on 8 qubits

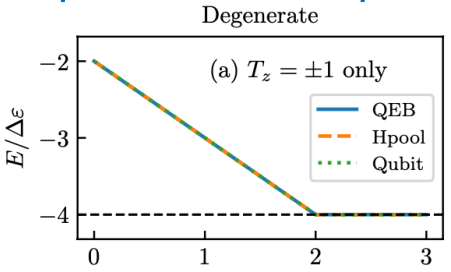

4 particles on 12 qubits

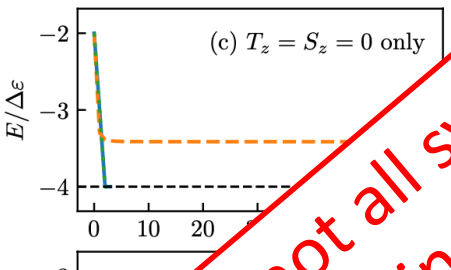
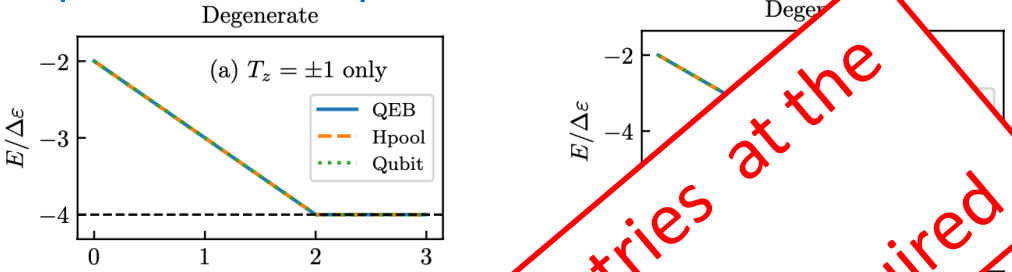

Maybe BUT not all symmetries at the
 Same time, but in any case
 Some control of symmetry is required

Different Hamiltonian limit

Case	S_z/T_z	Isoscalar			Isovector		
		-1	0	1	-1	0	1
1					✓		✓
2			✓			✓	
3					✓	✓	✓
4		✓	✓	✓	✓	✓	✓

Different operator pool in ADAPT-VQE breaking or not symmetries

	Particle number	Seniority	Parity
H-pool	✓	✓	✓
QEB-pool	✓	×	✓
Qubit-pool	×	×	✓

What about excited states?

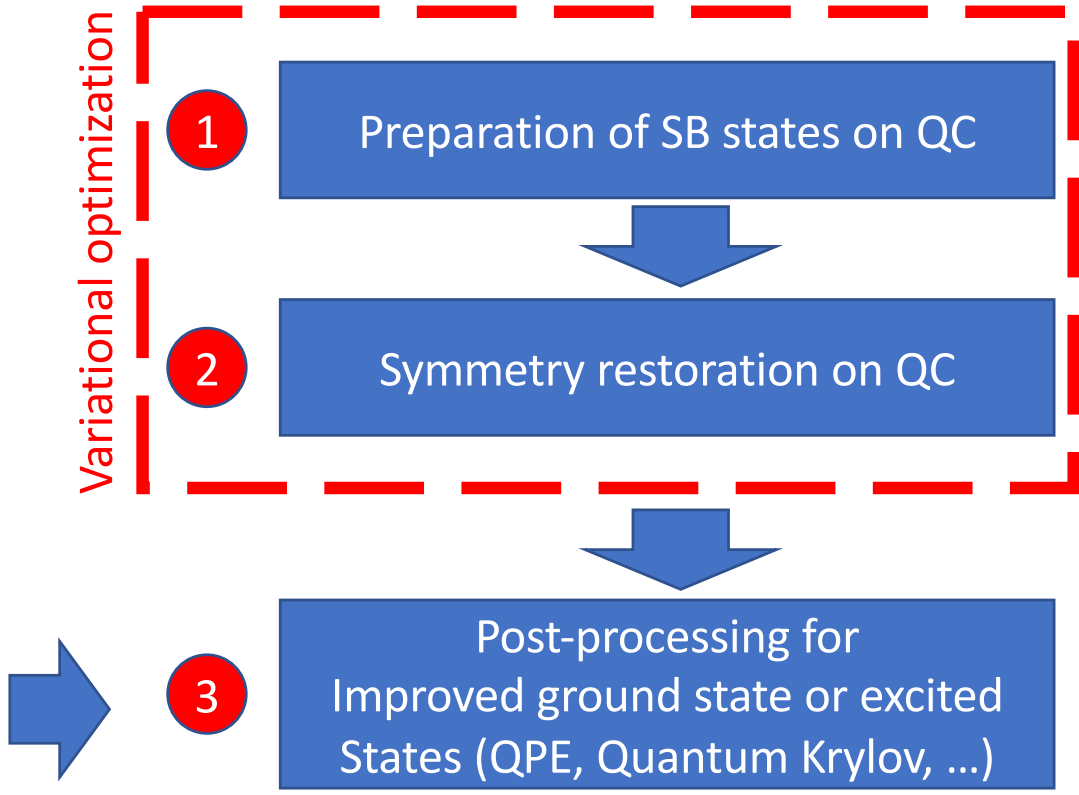
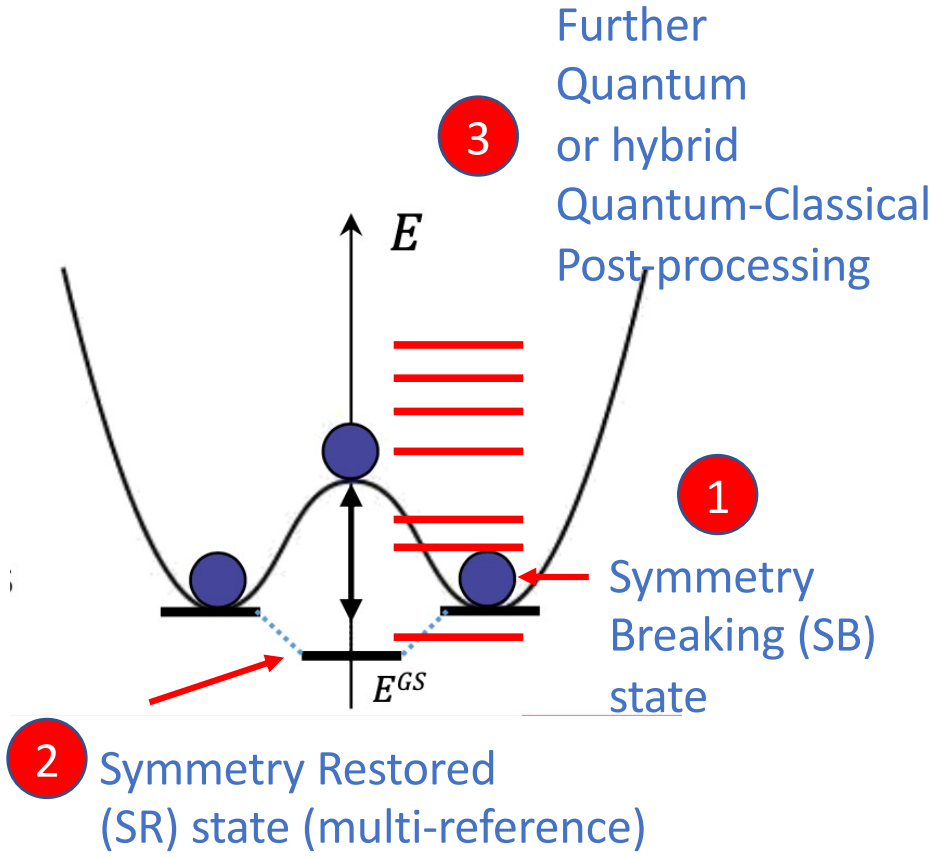

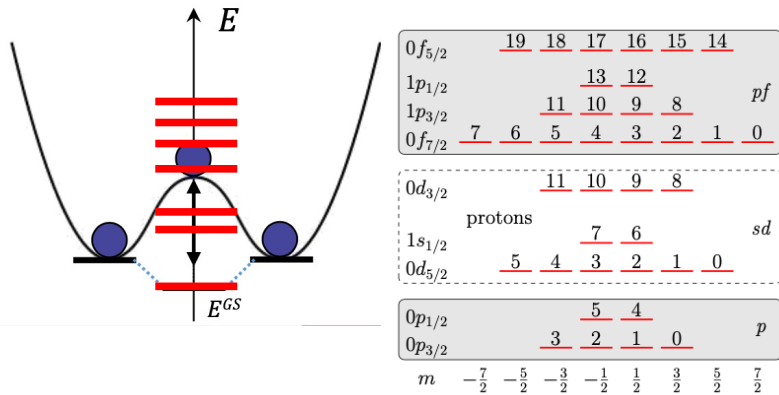

Today's challenges:

- Identify pilot applications,
- Reduce the Quantum resources
- Develop novel quantum algorithms

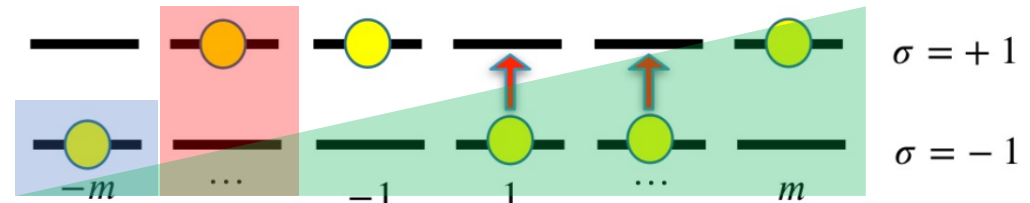

q = Number of qubits

Fermions-to-qubit: Jordan-Wigner

SU(2) encoding

J-scheme (compact)
+parity encoding

1 level = 1 qubit

$$q = 2N$$

2 levels = 1 qubit

$$q = N$$

$$|J, M\rangle \rightarrow |[M]\rangle$$

Use first quantization

$$q = \lceil \log_2 N \rceil$$

$$\begin{cases} X_\alpha = |1_\alpha\rangle\langle 0_\alpha| + |0_\alpha\rangle\langle 1_\alpha|, \\ Y_\alpha = i|1_\alpha\rangle\langle 0_\alpha| - i|0_\alpha\rangle\langle 1_\alpha|, \\ Z_\alpha = |0_\alpha\rangle\langle 0_\alpha| - |1_\alpha\rangle\langle 1_\alpha| \end{cases}$$

$$H = \frac{\varepsilon}{2} \sum_{\alpha=1}^N Z_\alpha + \frac{V}{4} \sum_{\alpha \neq \beta}^N (X_\alpha X_\beta - Y_\alpha Y_\beta),$$

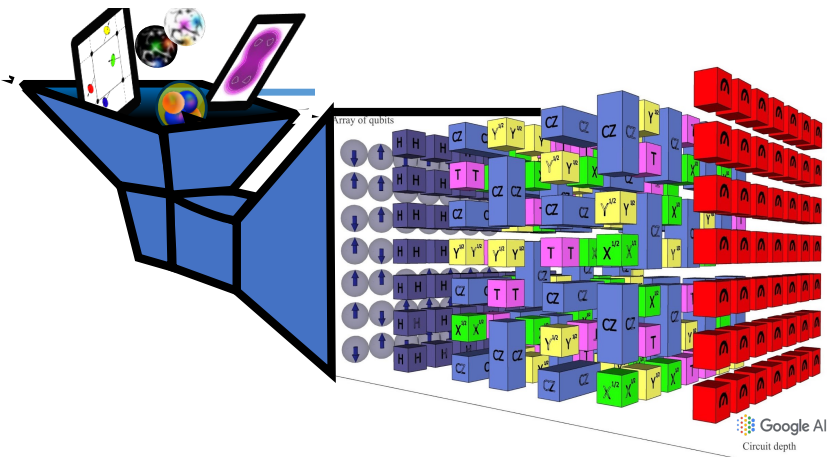

q = Number of qubits

Encoding the Lipkin model on a quantum register

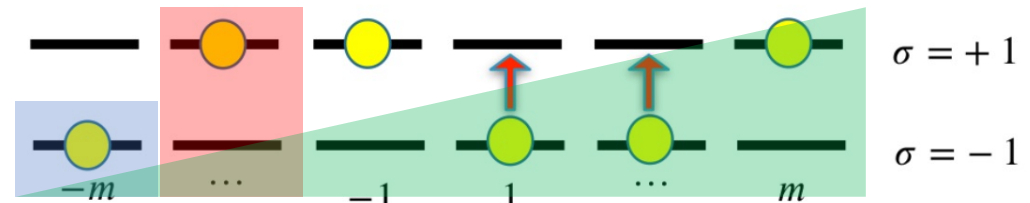

Fermions-to-qubit: Jordan Wigner

SU(2) encoding

J-scheme (compact) + parity encoding

ADAPT-VQE results

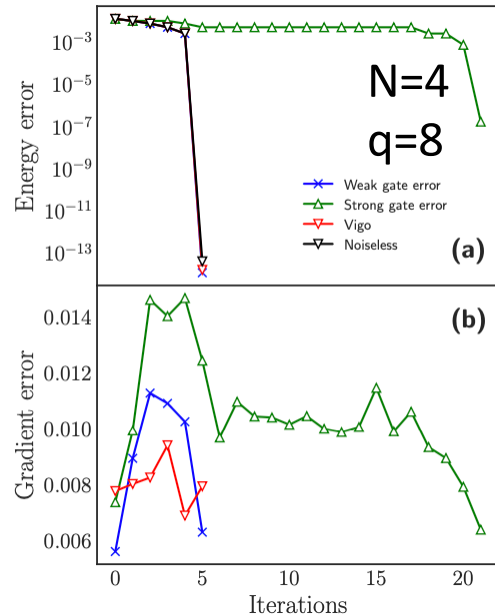

J. Romero et al, PRC 105 (2022)

VQE results

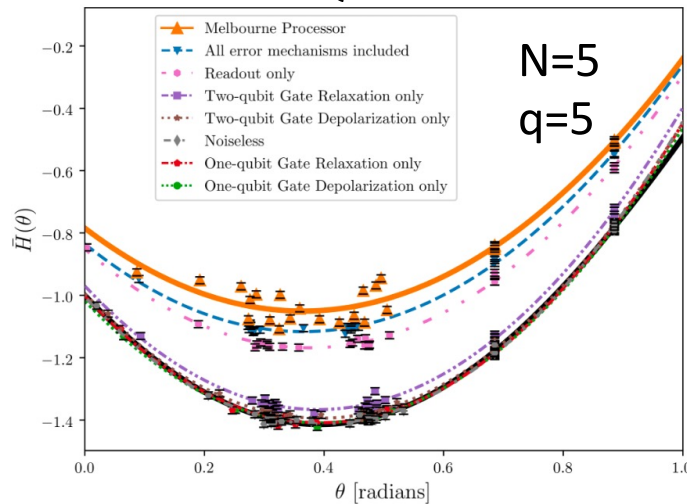

M. Cervia et al, PRC 104 (2021)

QEOM-technique

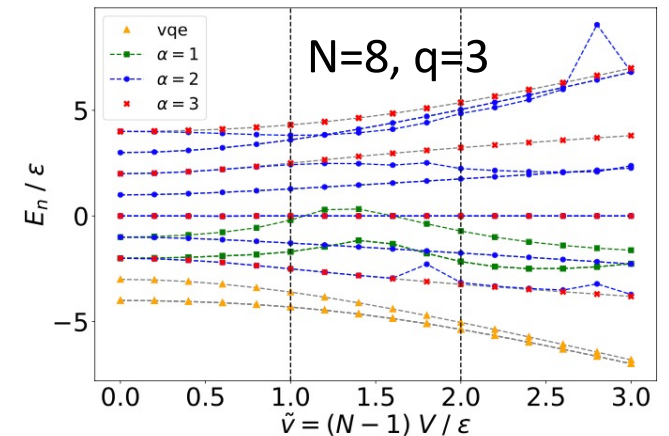

Hlatshwayo et al, PRC 106 (2022), & PRC 109 (2024)

Solving the Lipkin model with using 2 qubits only with hybrid quantum-classical method

Classical post processing

Quantum Subspace expansion

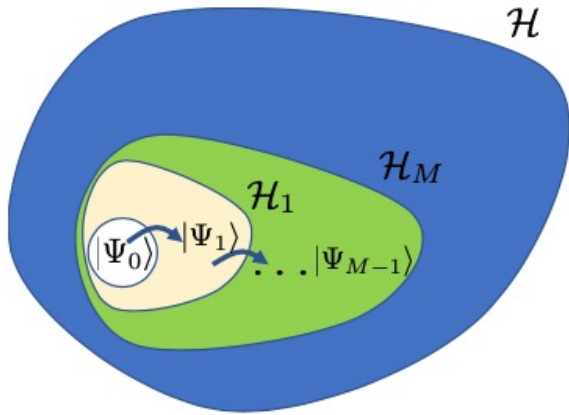

Quantum Generator Coordinate Method

$$|\Psi\rangle = \int_{\mathbf{q}} f(\mathbf{q}) |\Phi(\mathbf{q})\rangle d\mathbf{q}$$



$$\int_{\mathbf{q}'} d\mathbf{q}' [\mathcal{H}(\mathbf{q}, \mathbf{q}') - EN(\mathbf{q}, \mathbf{q}')] f(\mathbf{q}') = 0$$



Lipkin /perm. invariant

$$\langle H \rangle_{ll'} = \frac{\epsilon N}{2} i_{ll'}^{N-2} \left[i_{ll'} z_{ll'} + \frac{\chi}{2} (x_{ll'}^2 - y_{ll'}^2) \right]$$

one-body kernels

Illustration of Lipkin model on QC with noise

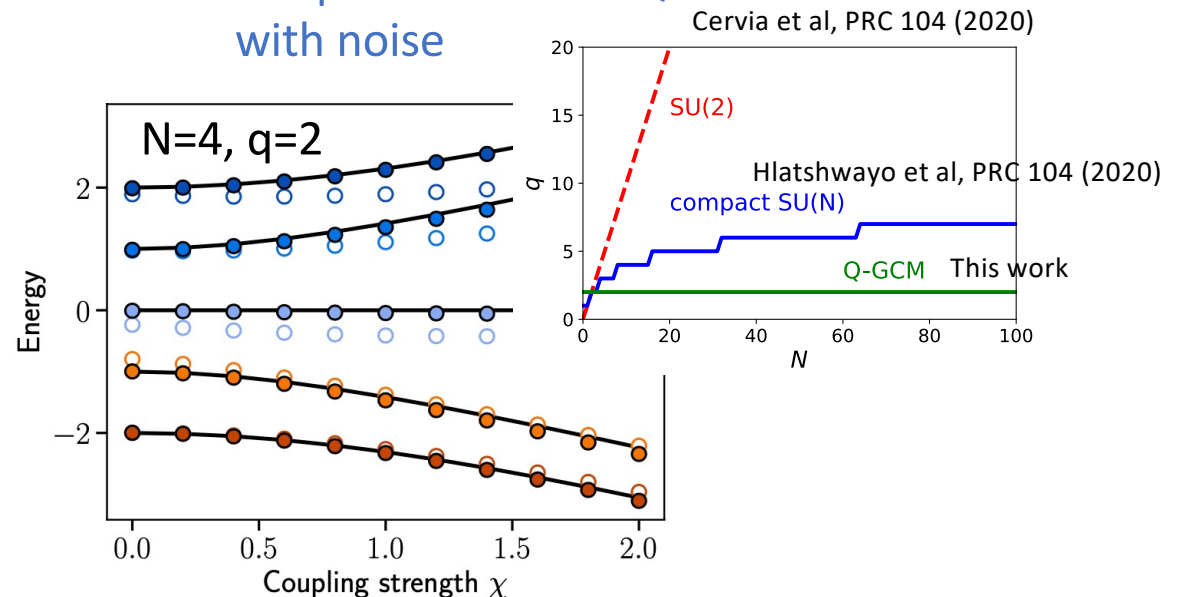

Real/Imaginary parts requires 2 qubits

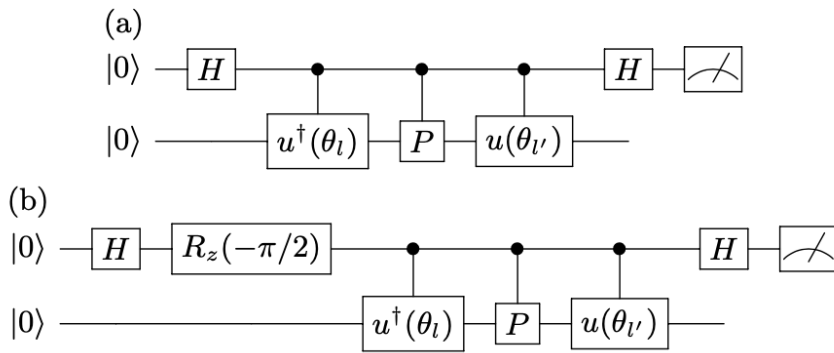

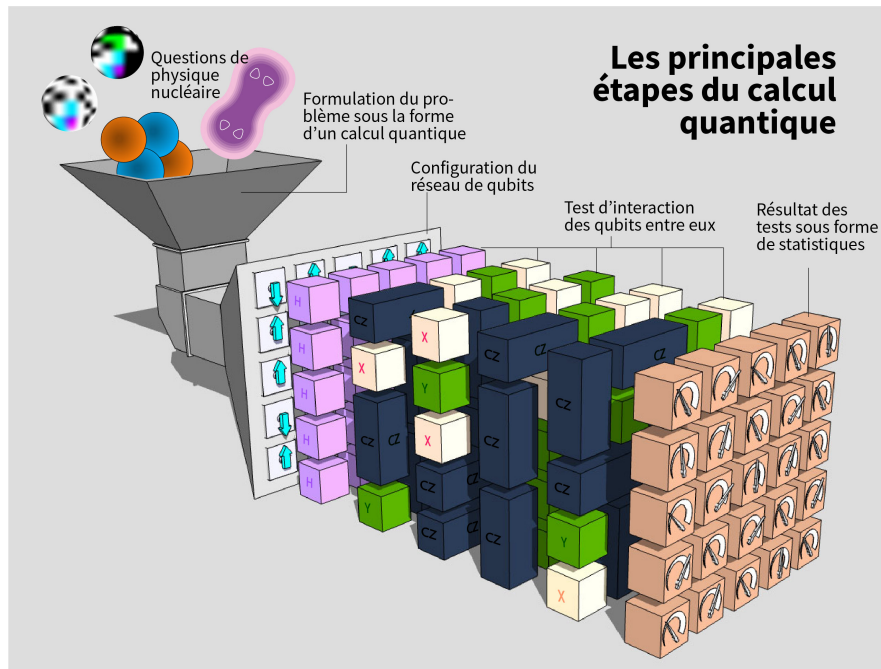

➔ The main goal was to find pilot applications for Quantum Computing where Qc can be disruptive compared to CC

➔ We first focused on the problem of Many-body / symmetries (that could be useful beyond many-body problems) - and developed various Techniques (QPE, Oracle, Shadow, Hilbert Space expansion, ... mostly post NISQ techniques)

➔ We are now gaining expertise on algorithmic, noise, ...

➔ Our current interest are: variational ansatz and expressivity, equilibrium and non-equilibrium properties, entanglement growth, ...