



HAL
open science

Thermal Rectification using Transition Metal Dichalcogenide Heterostructures

Markos Poulos, Konstantinos Termentzidis

► **To cite this version:**

Markos Poulos, Konstantinos Termentzidis. Thermal Rectification using Transition Metal Dichalcogenide Heterostructures. Journées Plénières GDR NAME 2023 (Rennes), Nov 2023, Rennes, France. hal-04793363

HAL Id: hal-04793363

<https://hal.science/hal-04793363v1>

Submitted on 20 Nov 2024

HAL is a multi-disciplinary open access archive for the deposit and dissemination of scientific research documents, whether they are published or not. The documents may come from teaching and research institutions in France or abroad, or from public or private research centers.

L'archive ouverte pluridisciplinaire **HAL**, est destinée au dépôt et à la diffusion de documents scientifiques de niveau recherche, publiés ou non, émanant des établissements d'enseignement et de recherche français ou étrangers, des laboratoires publics ou privés.

Abstract: Non-Equilibrium Molecular Dynamics simulations were performed to study thermal rectification effects in monolayer MoS₂/WS₂ lateral heterostructures. The parameters studied were the system length and the temperature bias ΔT . The maximum Thermal Rectification (TR) ratios found are of the order of 30%. The phonon Densities of States (pDOS) in the out-of-equilibrium steady state conditions were also probed, as well as the transmission of acoustic Phonon Wavepackets across the interface. We have found that non-linearities induced by large temperature biases ΔT are necessary for significant rectification ratios η .

Introduction/Context:

- Continuous **miniaturization** of devices leads to **hotspots** that limit their **efficiency**; need efficient **heat management** at the nanoscale
- Still, efficient nanoscale **thermal diodes** are not yet developed. Systems studied for **thermal rectification** include: *TMDC lateral heterostructures*¹, *hBN-graphene vdW heterostructures*², *trapezoidal and T-shaped graphene nanoribbons*³, *thickness asymmetric graphene nanoribbons*⁴, etc.
- In this work we studied the thermal rectification performance of **MoS₂/WS₂ monolayer lateral heterostructures**.

Methodology:

Non-Equilibrium Molecular Dynamics (NEMD)



1. Impose a Bias (ΔT or J)

2. Reach Steady-State

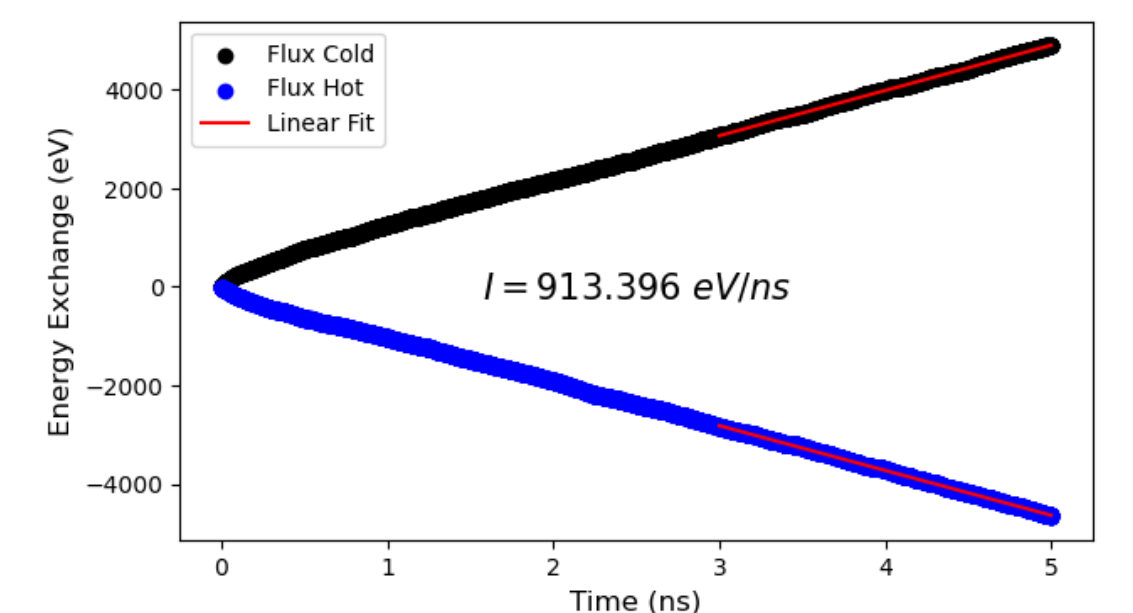
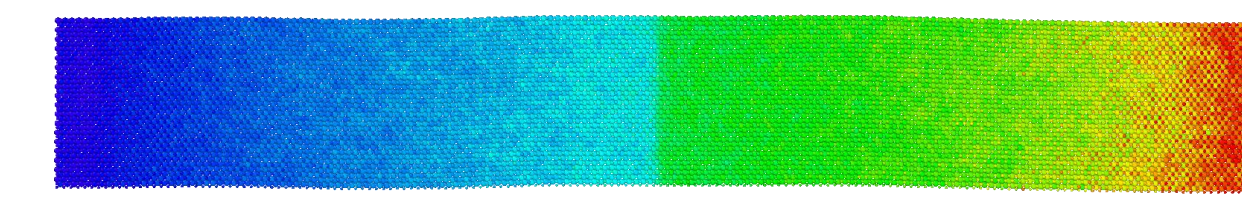

3. Measure Response (ΔT or J)

$$\kappa = \left(\frac{I}{A}\right) \cdot \frac{1}{\Delta T}$$

Conditions: Asymmetry + Non-linearity

$$q = \sum_s \int \frac{dk}{(2\pi)^3} \hbar \omega_{ks} n_{ks} v_{ks}$$

$$n_{ks} \approx n_{ks}^0 - \frac{\partial n_{ks}^0}{\partial (\hbar \omega_{ks})} \Theta_{ks} = n_{ks}^0 + \frac{n_{ks}^0 (n_{ks}^0 + 1)}{k_B T} \Theta_{ks}$$

$$\Theta_{ks} = -\Psi_{ks} \cdot \nabla T$$

$$q = \sum_s \int \frac{dk}{(2\pi)^3} \hbar \omega_{ks} v_{ks} \left(-\frac{n_{ks}^0 (n_{ks}^0 + 1)}{k_B T} \Psi_{ks} \cdot \nabla T \right)$$

Thermal Conductivity

Limit $\Delta T \rightarrow 0$

➤ **Higher ΔT** induces higher-order terms in n_{ks} , which is a **necessary condition** for non-reciprocity

➤ For systems symmetric along the gradient, even terms in ∇T vanish \rightarrow **asymmetry** is also a **necessary condition** for non-reciprocity

➤ Large $|\Delta T|$ induces a **mismatch in pDOS** that is **non-reciprocal** with inversion of the direction of $\Delta T \rightarrow$ reflected in the temperature dependence of $\kappa(T)$

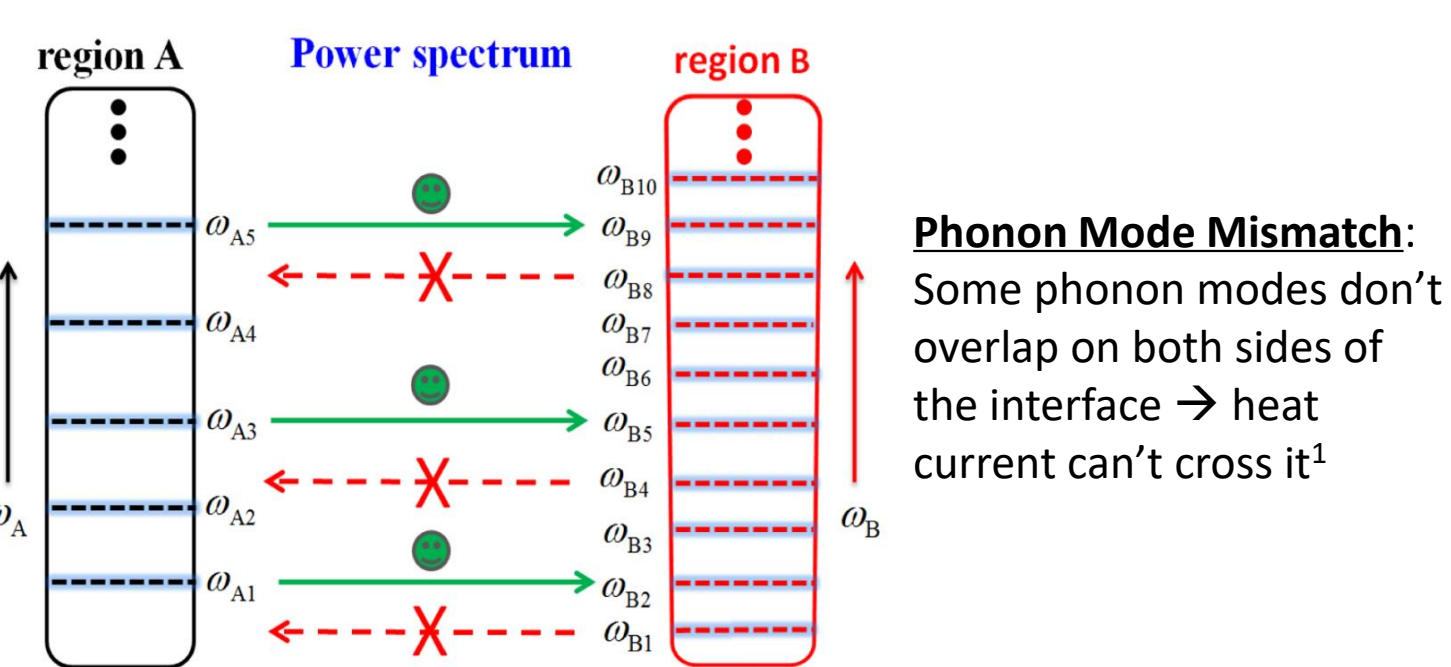

Temperature Dependence of Thermal Conductivities

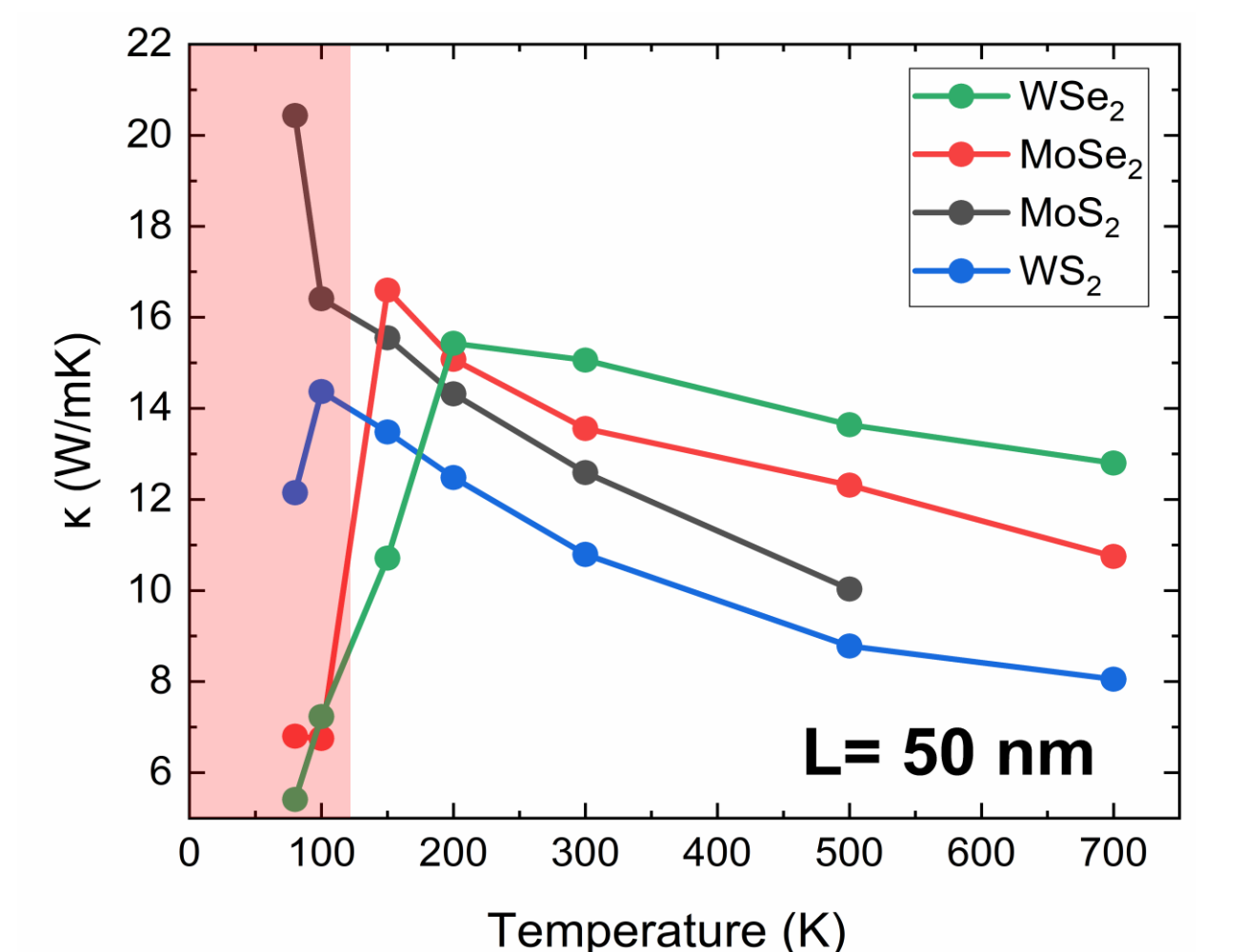
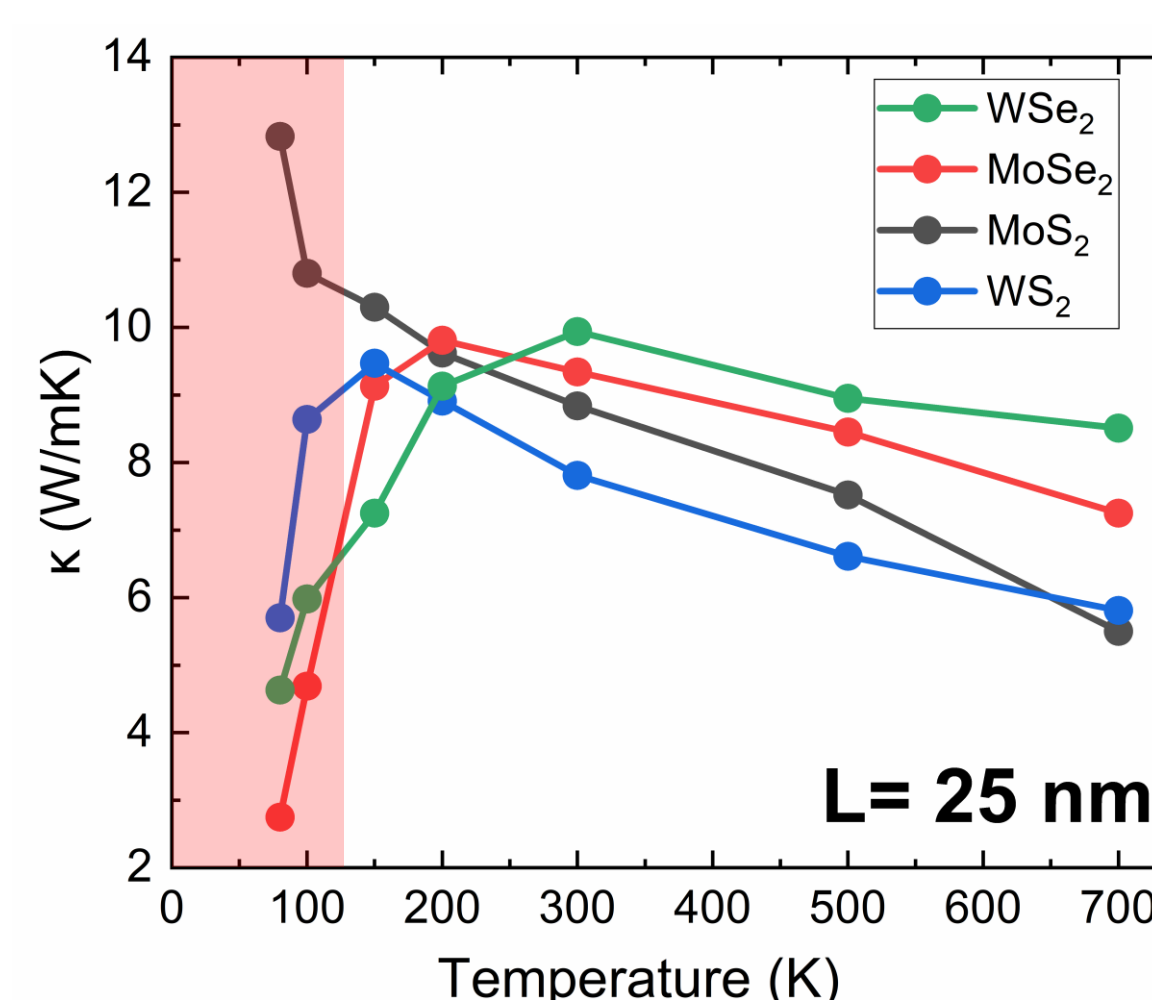

➤ At low $T \leq 150$ K, the heterostructures cannot reach proper steady state!

➤ At high $T \geq 700$ K the materials **decompose**

➤ Thermal conductivity κ of TMD's follows a **monotonous trend**: WS₂ \rightarrow MoS₂ \rightarrow MoSe₂ \rightarrow WSe₂

➤ Thermal conductivity **increases with length**

➤ Temperature dependence of $\kappa(T)$ **non-monotonous trend**; inflection point depending on material and length!

Rectification: Larger Temperature Bias ΔT enhances the Rectification Ratio η

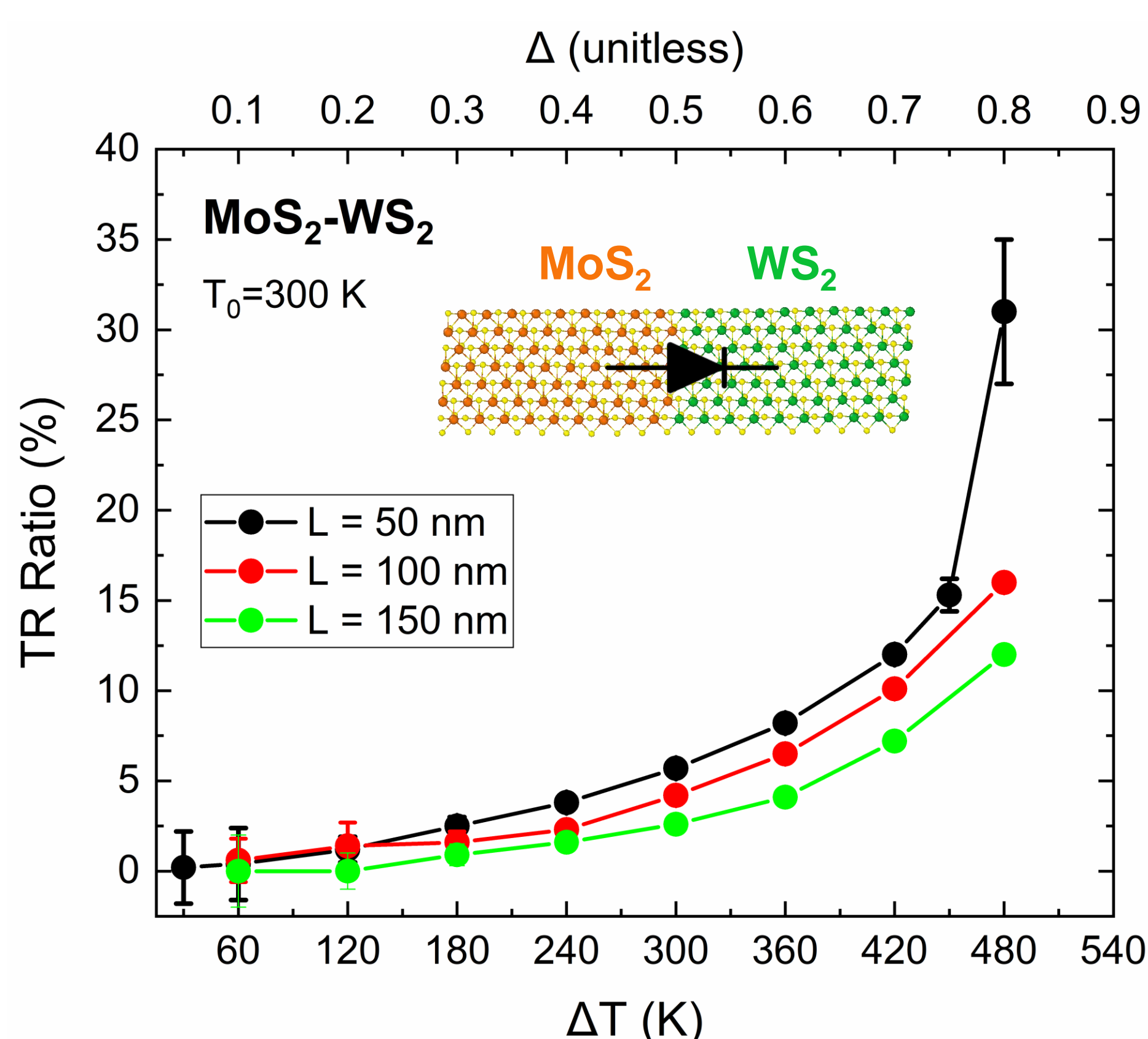

Rectification Ratio η increases with ΔT

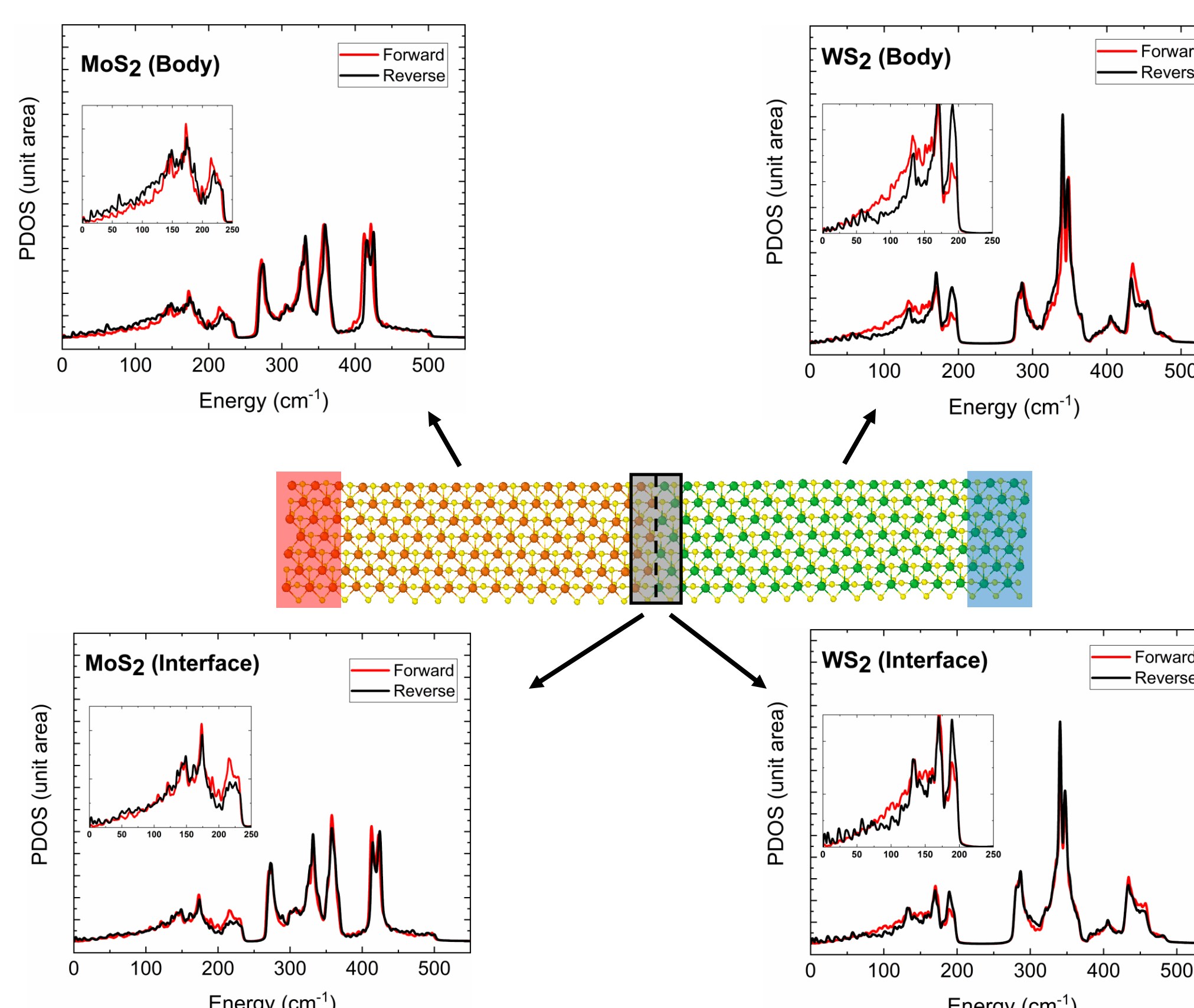

Non-Equilibrium pDOS depends on ∇T (direction + magnitude)

Phonon Wavepacket Propagation

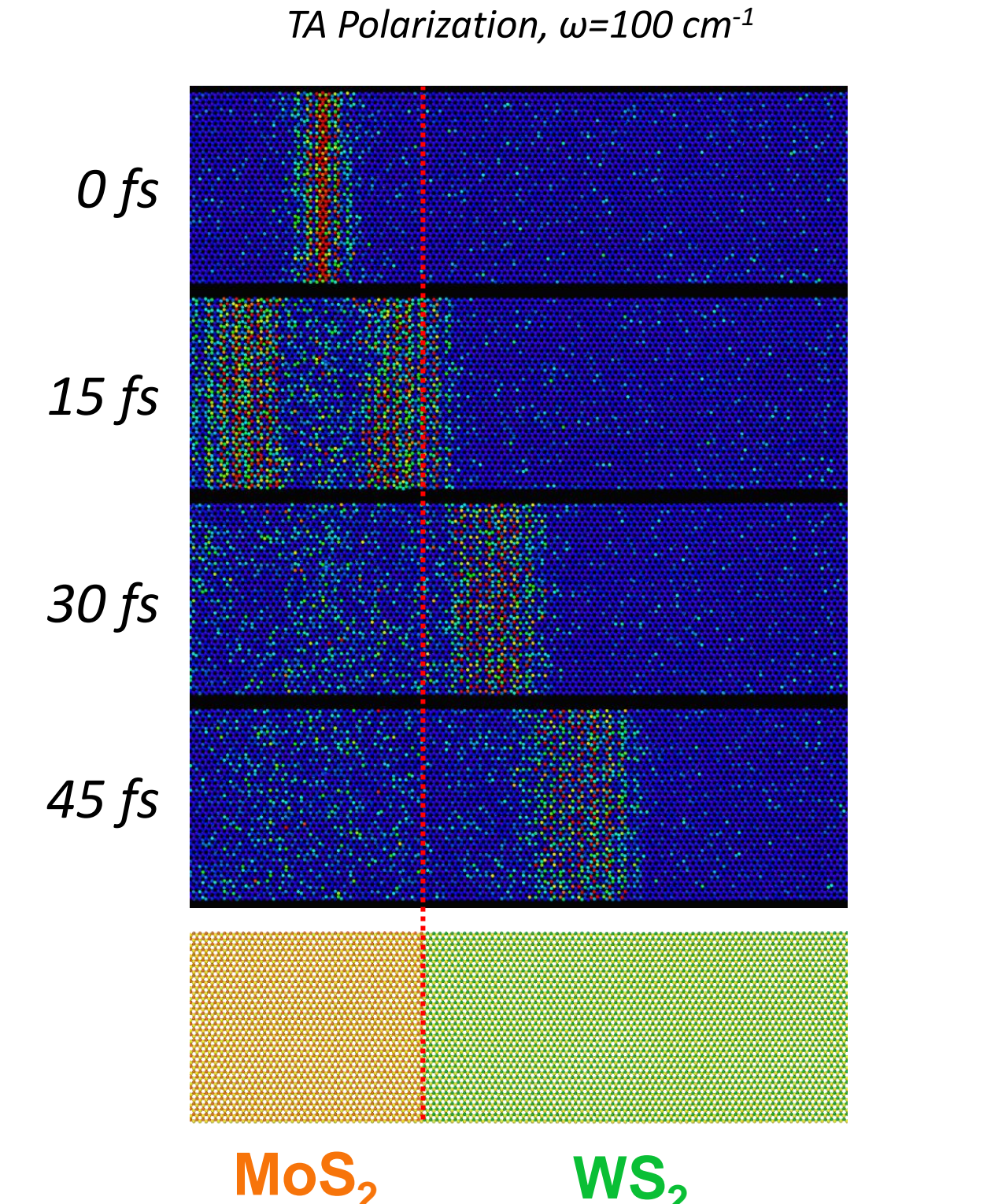

Acoustic phonons don't "see" the interface!

Conclusions

- **Large temperature biases ΔT** necessary for significant rectification ratios η
- Under **non-equilibrium** conditions the pDOS are **non-constant**: **acoustic phonons are affected the most**
- The **acoustic phonons** responsible for thermal transport are **poorly scattered by the interface**:

Perspectives

- Find correlations of pDOS overlaps with η for different T-biases ΔT (Phonon Mismatch model)
- Explore the effects of the average temperature T_0 of the heterostructure on η
- Apply to different combinations of TMD's (with potential lattice mismatch strain)
- Implement experimentally

References:

[1] Zhang et al., *Science* **378**, 169-175 (2022)

[2] Chen et al., *ACS Appl. Mater Interfaces* **12**, 15517-15526 (2020)

[3] Wang et al., *Nano Lett.* **378**, 169-175 (2013)

[4] Zhong et al., *Appl. Phys. Lett.* **99**, 193104 (2011)