



**HAL**  
open science

# Computational heterogeneous electrocatalysis: How does it work and which questions can be answered at which cost?

Stephan N. Steinmann

► **To cite this version:**

Stephan N. Steinmann. Computational heterogeneous electrocatalysis: How does it work and which questions can be answered at which cost?. Doctoral. Webinar, France. 2024. hal-04792921

**HAL Id: hal-04792921**

**<https://hal.science/hal-04792921v1>**

Submitted on 20 Nov 2024

**HAL** is a multi-disciplinary open access archive for the deposit and dissemination of scientific research documents, whether they are published or not. The documents may come from teaching and research institutions in France or abroad, or from public or private research centers.

L'archive ouverte pluridisciplinaire **HAL**, est destinée au dépôt et à la diffusion de documents scientifiques de niveau recherche, publiés ou non, émanant des établissements d'enseignement et de recherche français ou étrangers, des laboratoires publics ou privés.

# Computational heterogeneous electrocatalysis: How does it work and which questions can be answered at which cost?

Stephan N. STEINMANN

# Research interests

## Reactivity at (electrified) interfaces

**Surface state:** Fang, Ding, Zhang, [Steinmann](#), Hu, Mao, Feliu, Tian *J. Am. Chem. Soc.* **2020**, 142, 9439.

**OER:** Curutchet, Colinet, Michel, [Steinmann](#), Le Bahers. *Phys Chem Chem Phys* **2020**, 22, 7031.

**HER:** Abidi, Bonduelle, [Steinmann](#) *ACS Appl Mater Interfaces* **2020**, 12, 31401.

## Solid-state

**g-CN:** Li, Melissen, Le Bahers, Sautet, Masters, [Steinmann](#), Maschmeyer, *Chem. Mater.* **2018**, 30, 4253.

**MoS<sub>3</sub>:** Sahu, [Steinmann](#), Raybaud, *Cryst. Growth Des.* **2020**, 20, 7750.

**MnO<sub>2</sub>:** Manceau, [Steinmann](#), *ACS Earth Space Chem.* **2023**, 7, 1459.

## Method development for solid/liquid interface

**Force fields:** Clabaut, Beisert, Michel, [Steinmann](#) *J Chem. Phys.* **2022**, 157, 194705.

**Solvation energy:** Clabaut, Schweitzer, Goetz, Michel, [Steinmann](#) *J Chem Theory Comput.* **2020**, 16, 6539.

**Electrostatic embedding:** Abidi, [Steinmann](#), *ACS Appl Mater Interfaces* **2023**, 15, 25009.

# How do noble metal electrocatalysts look like?

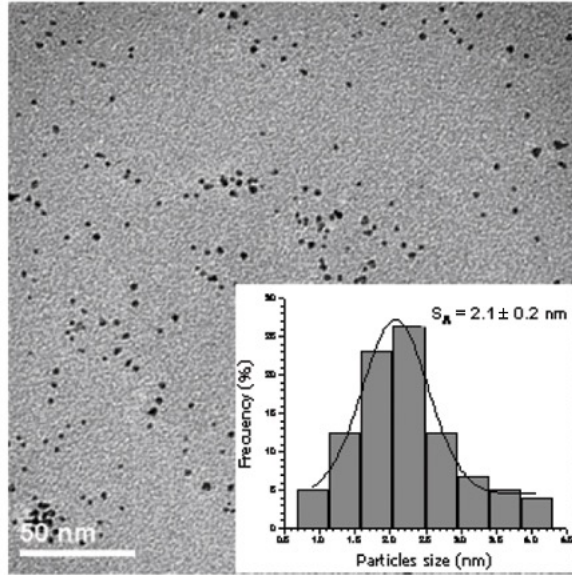
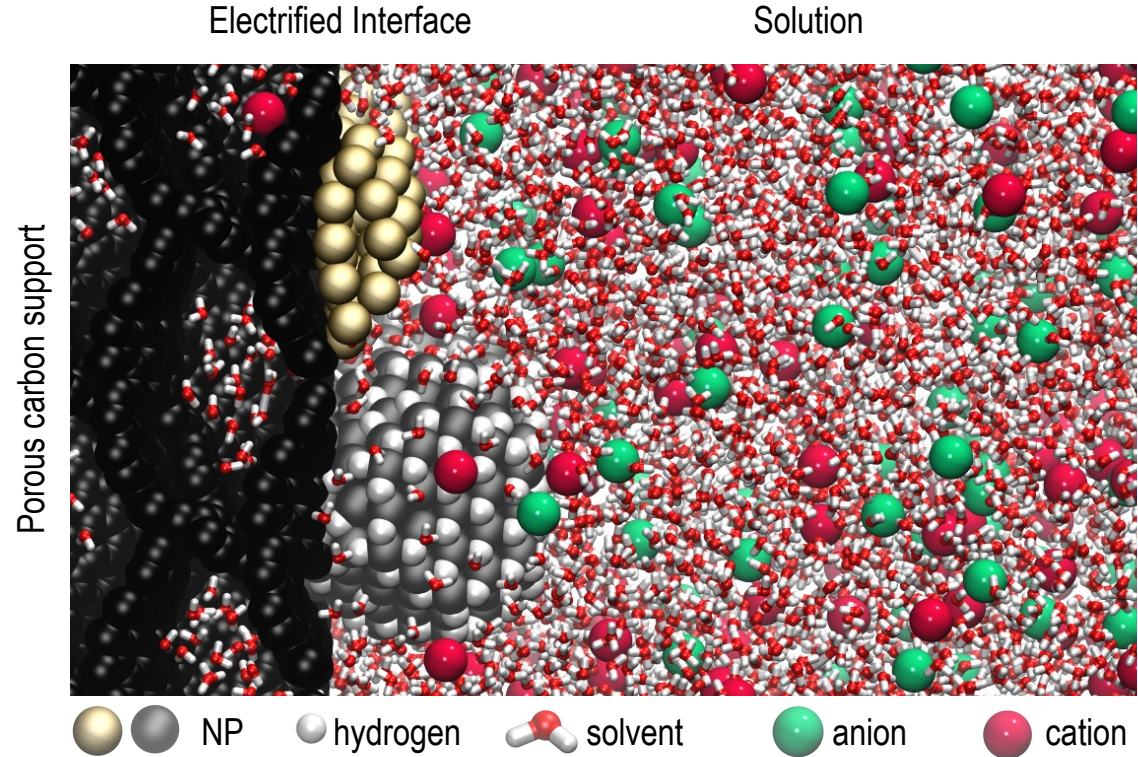

Figure 1: A typical TEM image of the Pt nanoparticles with size distribution histogram.



# Atomistic models for electrocatalysis?

Solvent

Ions

Adsorbates

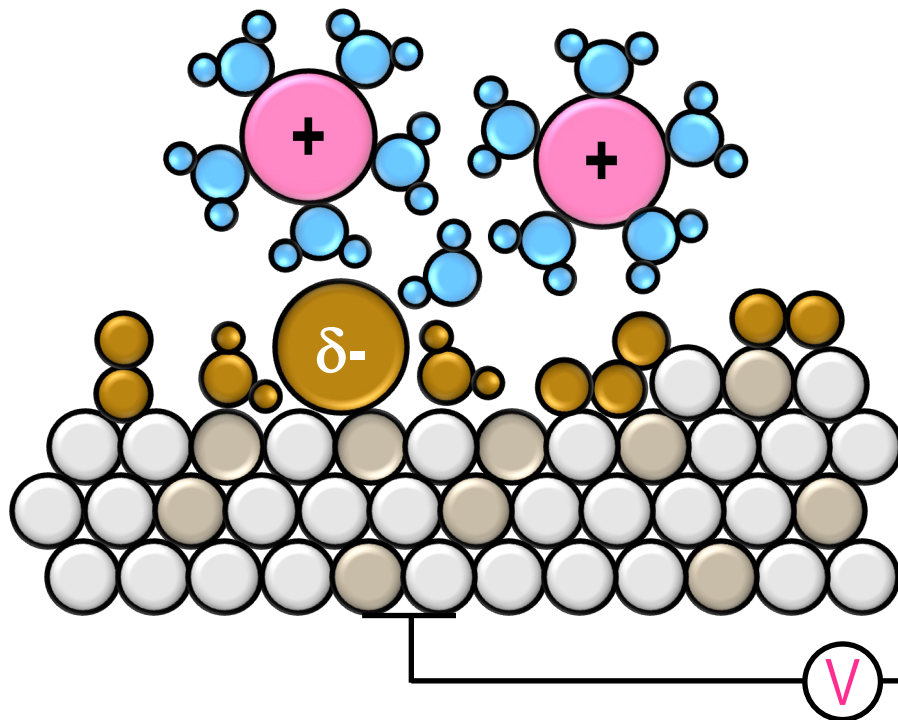

Restructuring

Reactivity

Electrochemical potential

# Models in practice

Large nanoparticles  
→ Periodic surface model

Solvent

None

Implicit

QM/MM

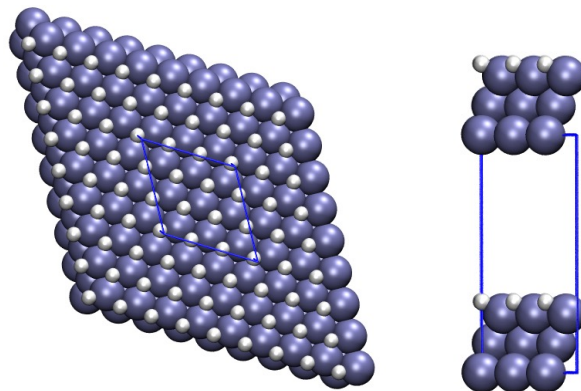

Electrochemical potential

Implicit: CHE

Explicit: GC-DFT

# Grand-Canonical DFT

Grand-Potential  $\Omega$  :

The energy of GC-DFT

$$\Omega(U) = E(q) - U \times q$$

U: potential  
q: charge

E(q): Electronic energy at charge q

Poisson-Boltzmann Equation neutralizes q

**Implicit solvent + Electrolyte**

## Grand-Canonical DFT

Grand-Potential  $\Omega$  :  
The energy of GC-DFT

$$\Omega(U) = E(q) - U \times q$$

$U$ : potential  
 $q$ : charge

$E(q)$ : Electronic energy at charge  $q$

Poisson-Boltzmann Equation neutralizes  $q$   
**Implicit solvent + Electrolyte**

Semi-conductor: A piece-wise parabola

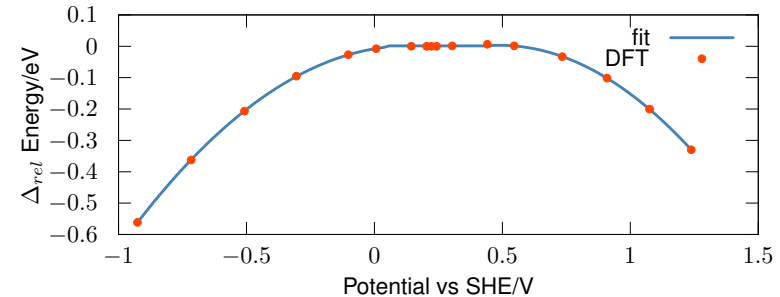

Conductor: A Single parabola



# Grand-Canonical DFT in practice

The impact of electrode polarization is system dependent

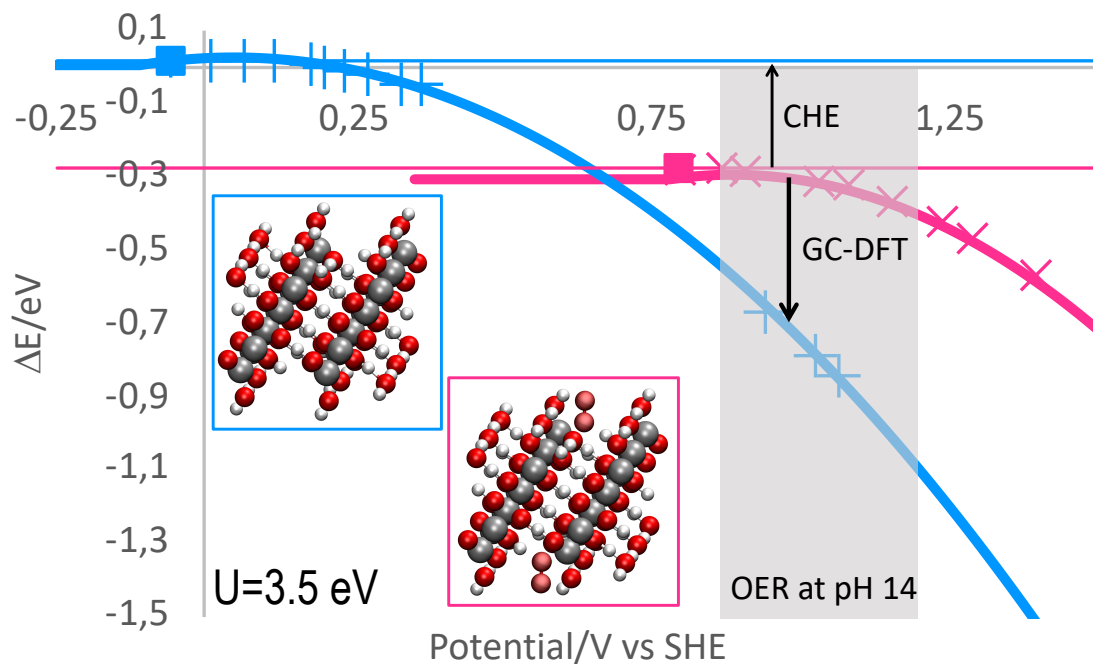

The **potential modifies** the qualitative behavior of "chemical" steps

# How to model the water/metal interface?

Diffusion at interfaces is slow:  
~500 ps for equilibration

DFT for metals is costly  
~140 kCPUh for 10 ps, est. 8 years for 500 ps

Interaction is neither weak nor strong  
Problem for force fields

Interfaces are amorphous:  
Large cells required

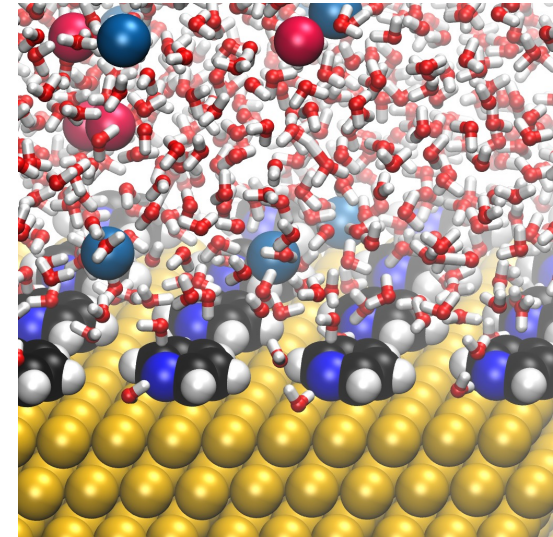

# Aromatics at Pt(111)/water interface

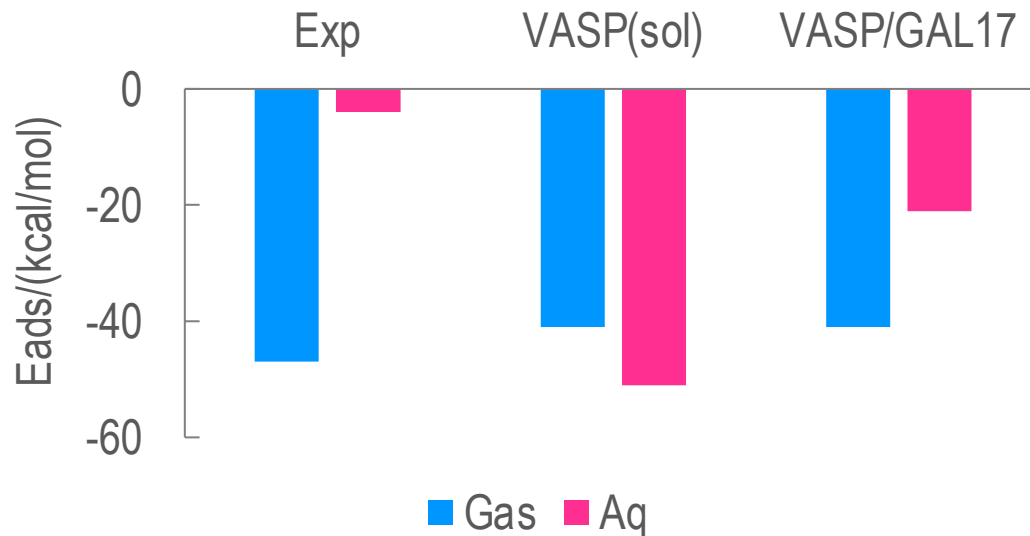
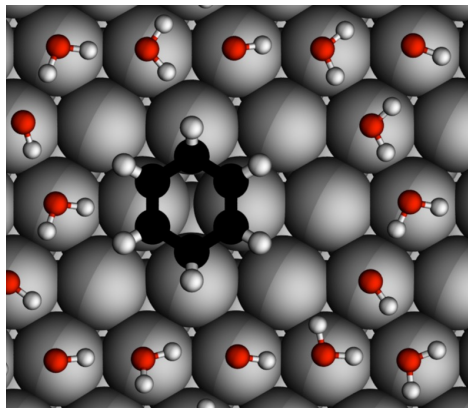

→ **Semi-quantitative** agreement between theory and experiment

# What about kinetics?

Transition states determine the kinetics of reactions

The number of atoms needs to be conserved from the reactant to the product

Chemical steps:  $\text{H}^* + \text{CO}_2^* \rightarrow \text{HCOO}^*$   $\mapsto$  “standard”

Electrochemical steps:  $\text{H}^+ + \text{e}^- + \text{CO}_2^* \rightarrow \text{HCOO}^*$   $\mapsto$  non-standard

## Transition states in electrocatalysis

**(Electro-)chemical transition states**

Transition states determine the kinetics of reactions

“electrochemical” TS

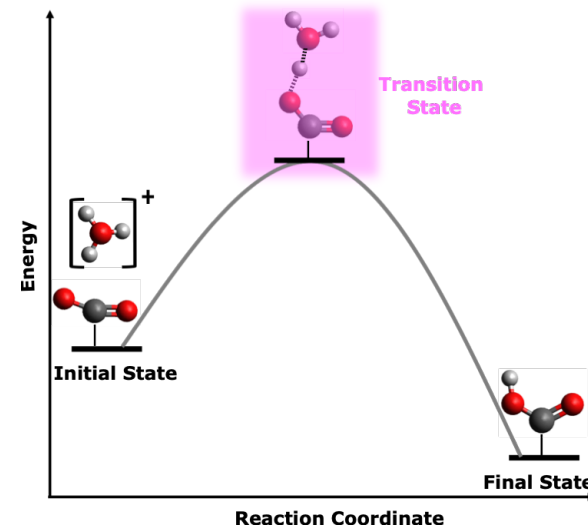
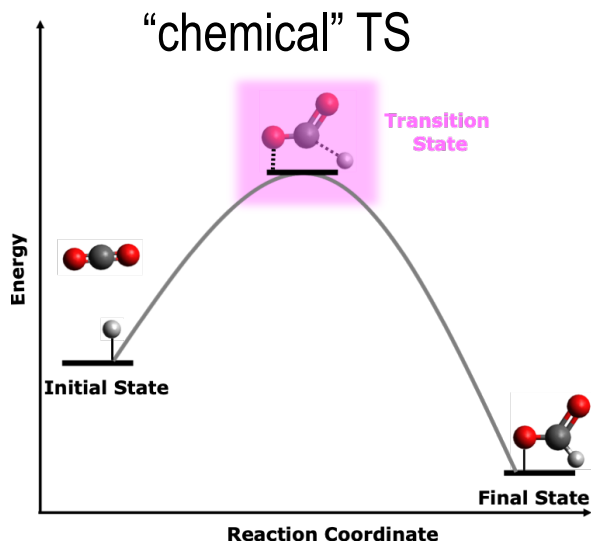

Most computational work in electrocatalysis ignore transition states

# Transition states in electrocatalysis

## Chemical steps

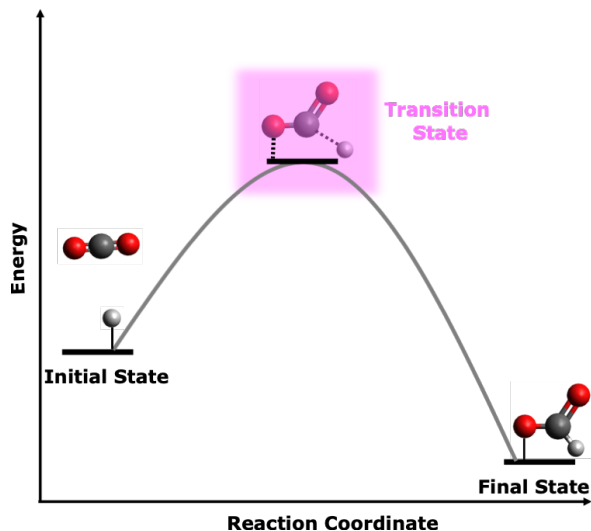

Standard techniques in heterogeneous catalysis

2 weeks to 1 month of real time\*

\*not 100% of human time

# Transition states in electrocatalysis

## Electrochemical steps

Difficult to identify

1-3 month of real time\*

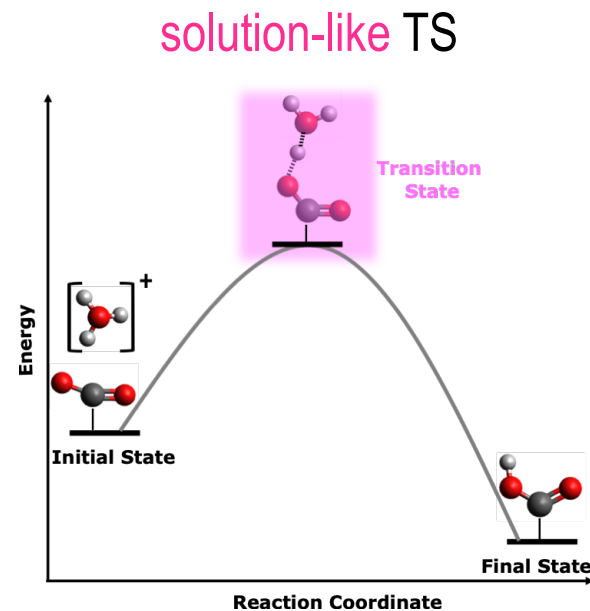

\*not 100% of human time

## Transition states in electrocatalysis

## Electrochemical steps

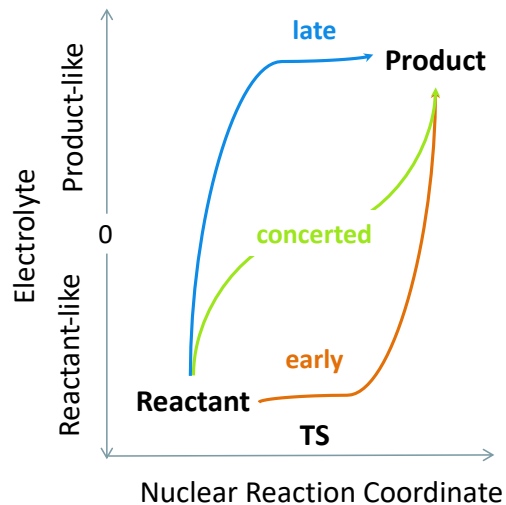

Reorganisation of:

- Solvent
- Adsorbate@surface

- Marcus theory?
- Active research

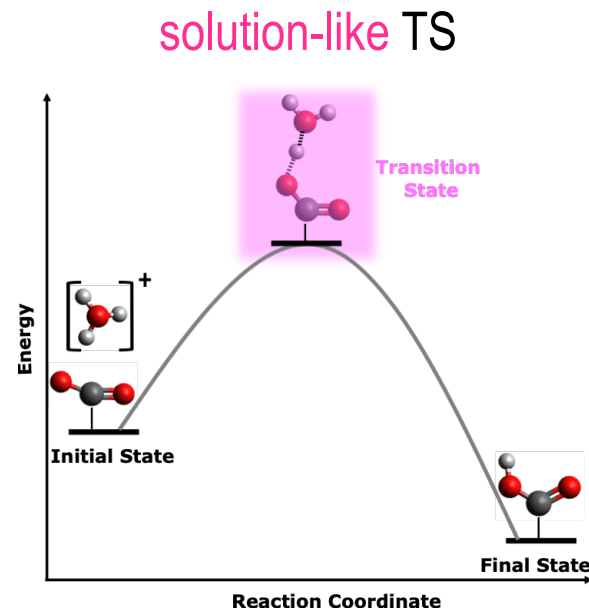

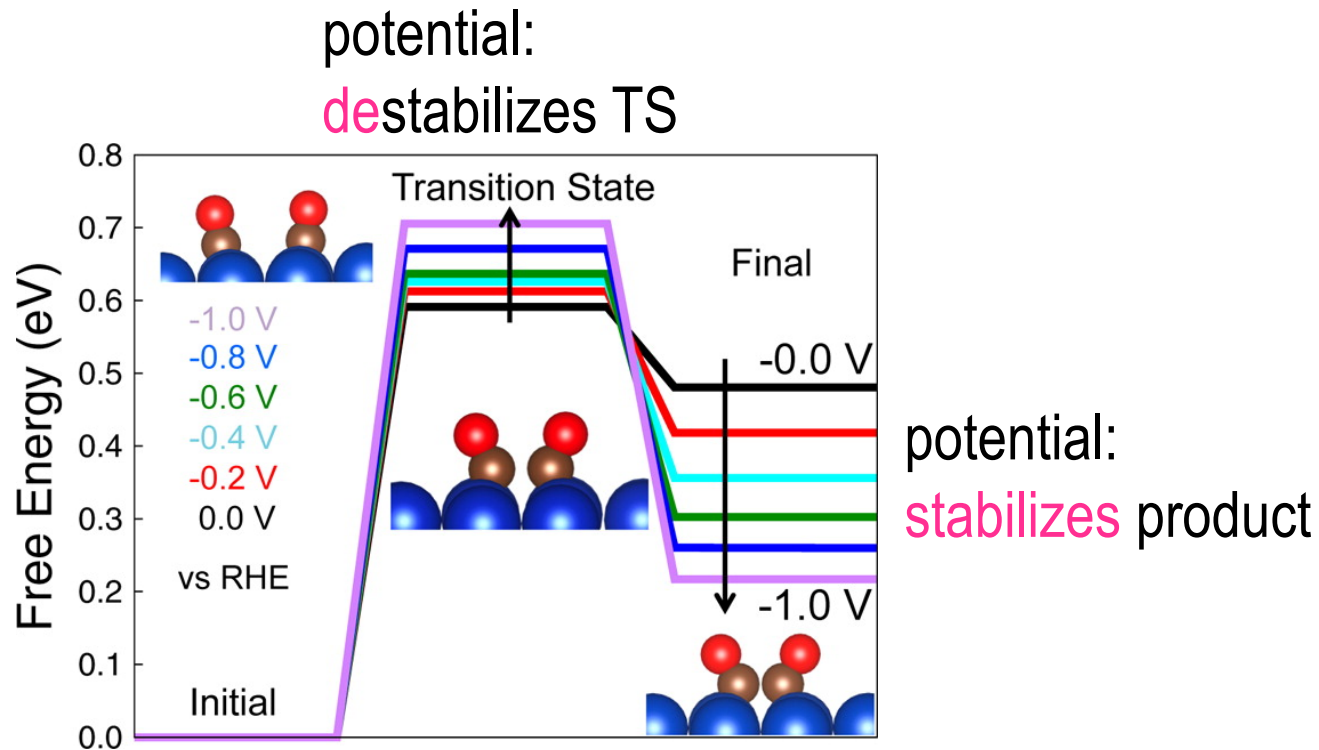

## Transition states in electrocatalysis

**Oddly behaving transition states can be found**

# HER mechanism on V<sub>S</sub> defect

Chemical (Tafel) step

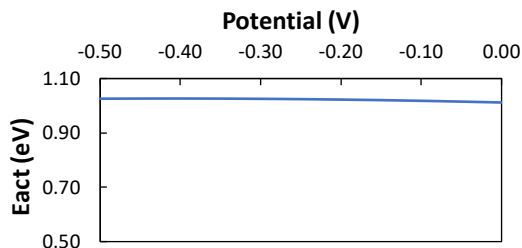
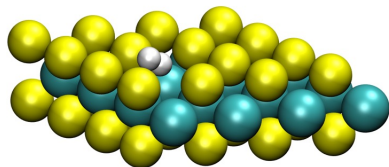

Slope:  
Symmetry factor from GC-DFT

Electrochemical (Volmer) step

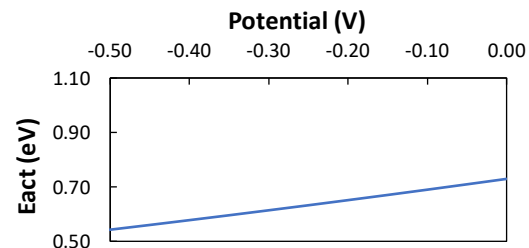
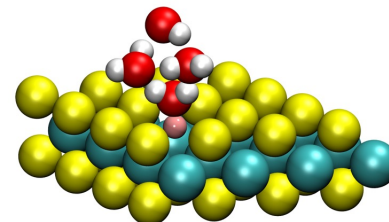

EPOC: CH<sub>4</sub> activation over Pt

# Importance of the surface state

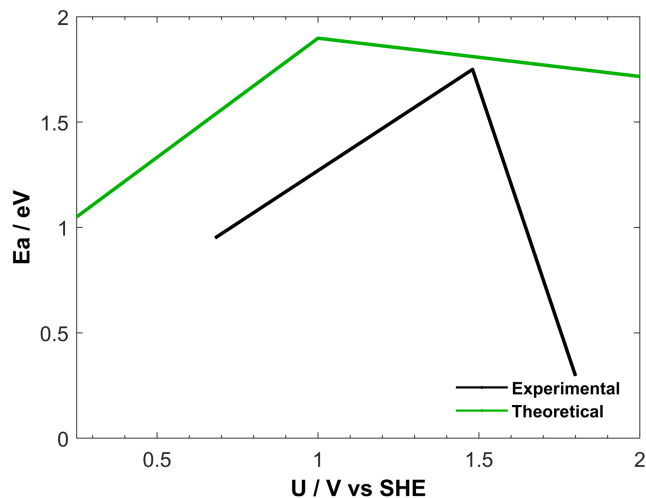
Accelerating CH<sub>4</sub> oxidation over Pt via an electrochemical potential

Effective activation energy

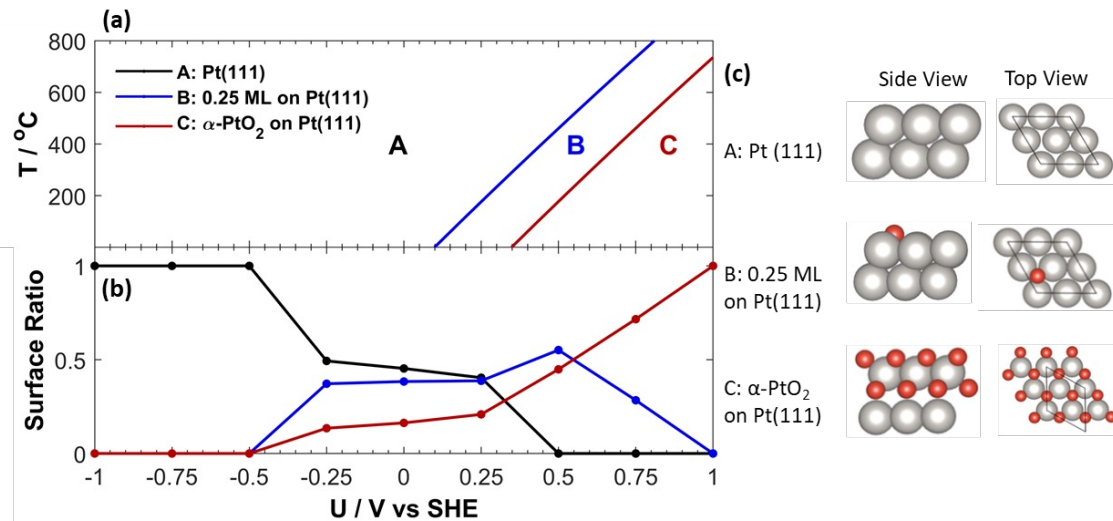

Surface state as a function of T and U

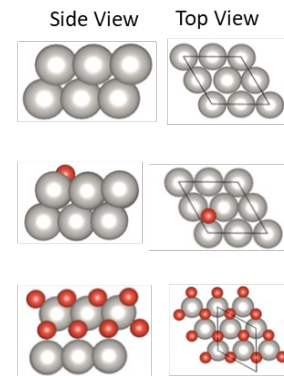

# Partial take home message

Periodic surface models are most convenient

The effect of the electrochemical potential can be modeled with GC-DFT

Implicit solvents are very practical but have limitations

TS: rarely considered and painful to identify for electrochemical steps

The surface state changes dramatically as a function of the potential

# 1. Sulfate on Au(111)

2. HER on MoS<sub>2</sub>: Screening of dopants

3. Structural complexity

4. Reaction pathways

# The gold sulfuric acid interface is prototypical

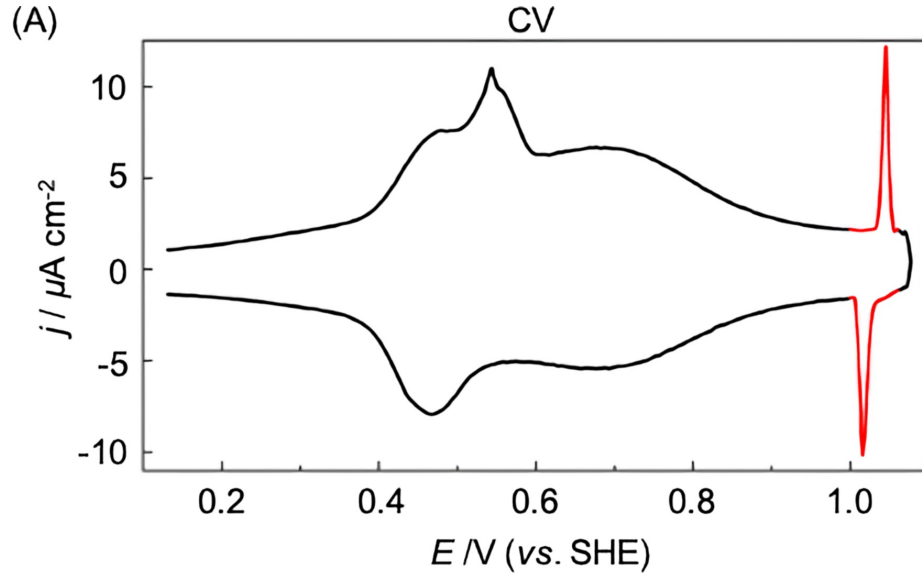

Indication of a phase transition

→ What is the structure?

# Experimental characterization of ordered phase

EC-STM

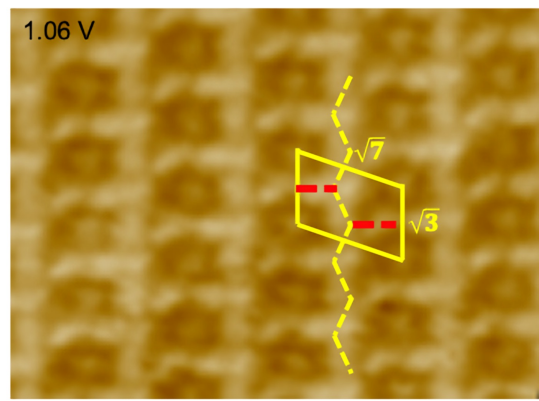

EC-IR

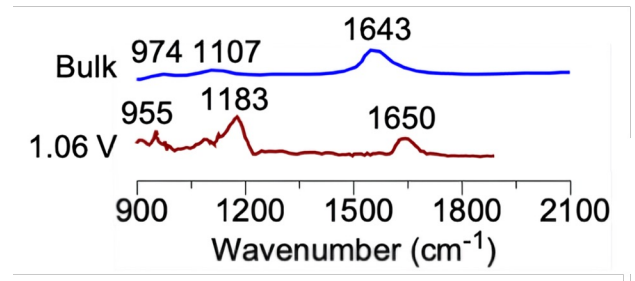

EC-Raman (SHINER)

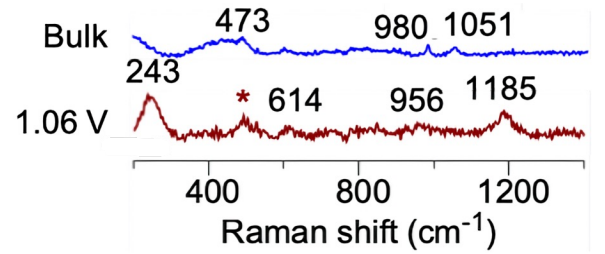

Characterization can barely be better

→ But still, what is the atomic structure of this phase??

# Computational identification of ordered phase

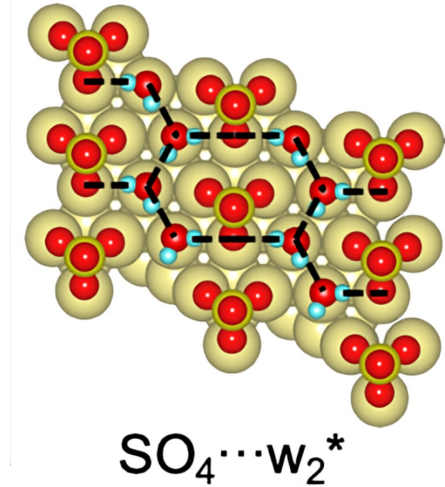
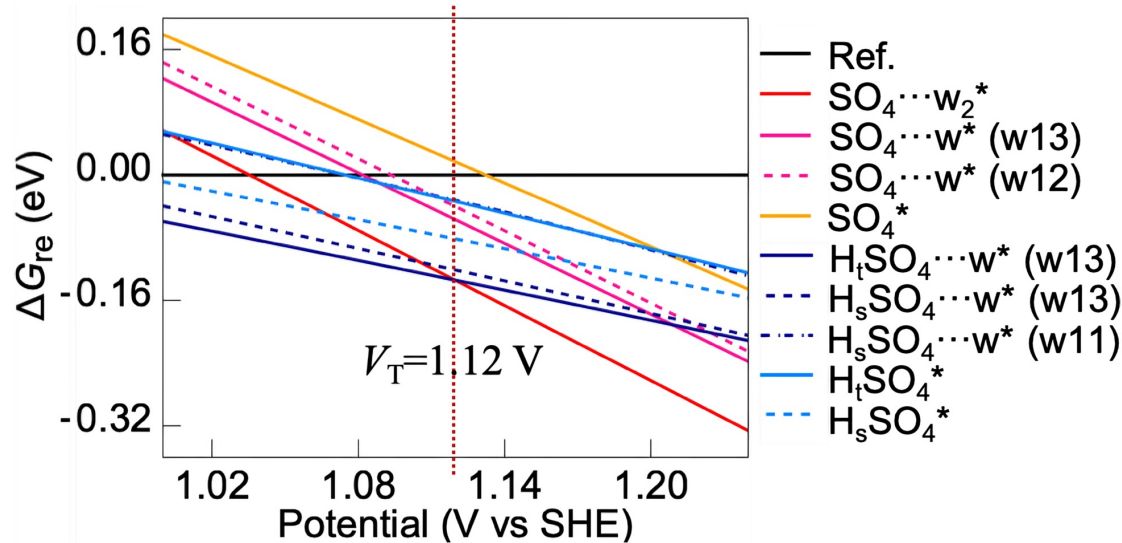

At positive potentials a very ordered water/SO<sub>4</sub> addlayer becomes most stable



$\text{SO}_4@Au(111)$ 

# Experiment and computations agree!

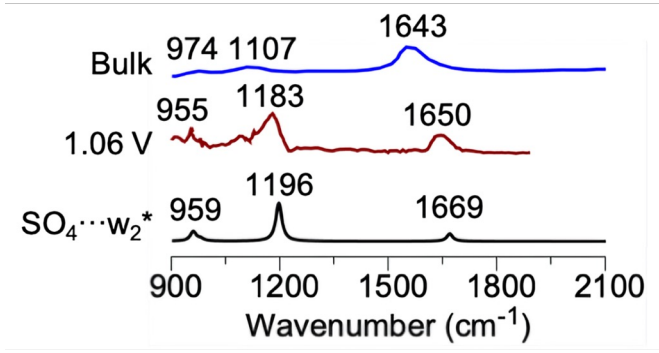

## EC-Raman (SHINERS)

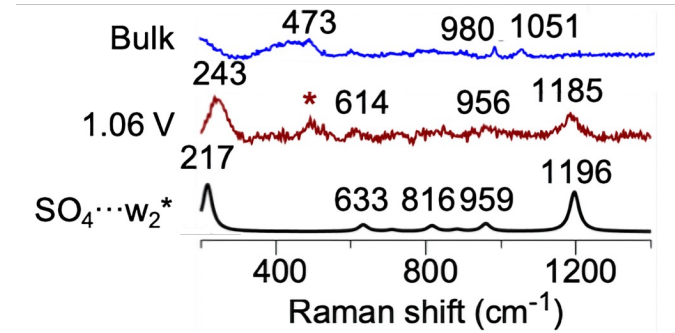

## EC-IR

STM

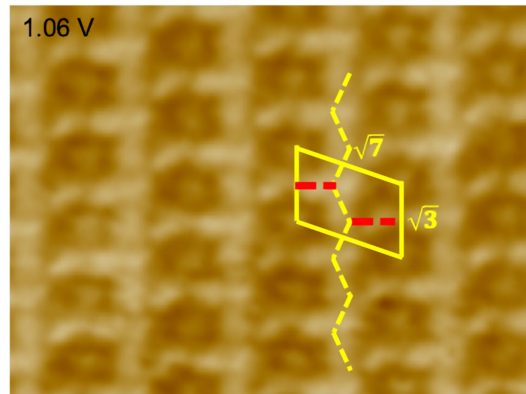
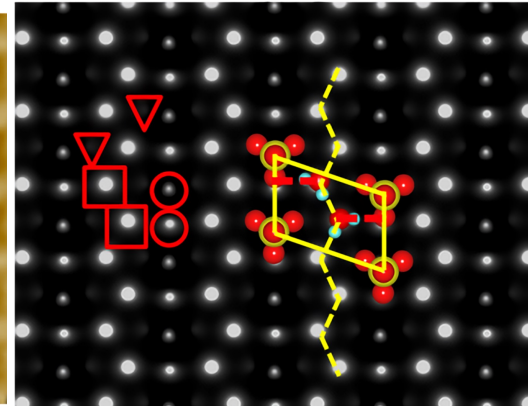
 $\text{SO}_4\cdots\text{W}_2^*$ 

# Partial take home message

Microscopy and spectroscopy for electrified interfaces are challenging

When available: Interpretation not always obvious

Computations can “convert” signals into atomic structures

→ More insights for (electro-)chemists

1. Sulfate on Au(111)

**2. HER on MoS<sub>2</sub>: Screening of dopants**

3. Structural complexity

4. Reaction pathways

Hydrogen evolution reaction on MoS<sub>2</sub>

# MoS<sub>2</sub> as an Hydrogen Evolution Reaction Catalyst

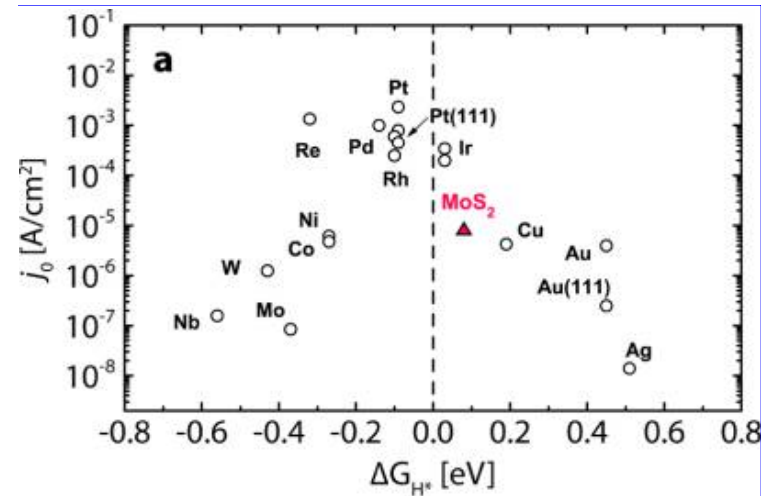
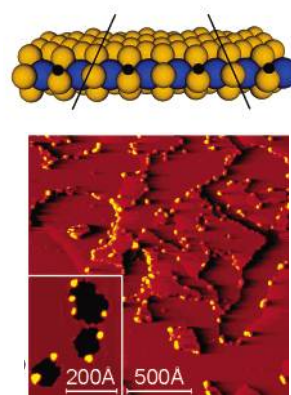
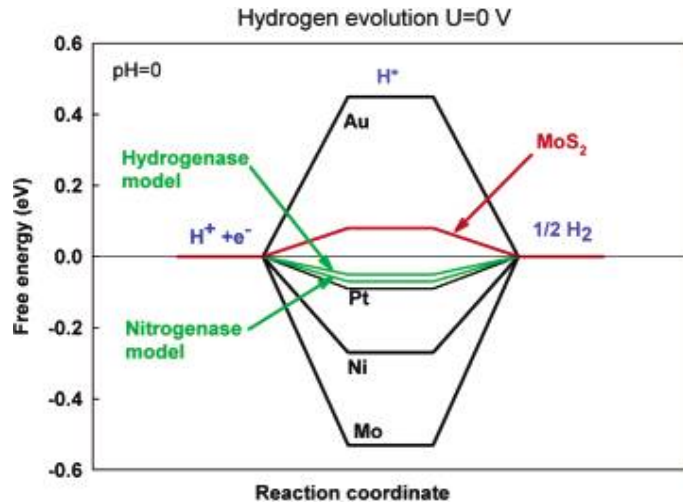

MoS<sub>2</sub> is one of the best low-cost HER catalysts in acidic conditions

”one of the best”, but not a good one

Hydrogen Evolution Reaction on MoS<sub>2</sub>

## Can We Activate the Basal Plane?

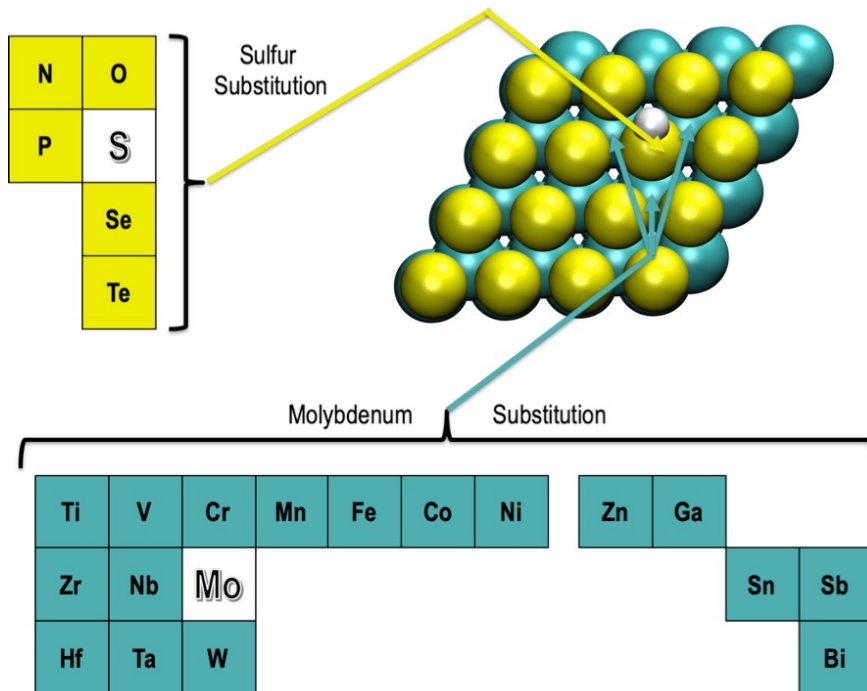

Ti	V	Cr	Mn	Fe	Co	Ni
Zr	Nb	Mo				
Hf	Ta	W				

Zn	Ga	
	Sn	Sb
		Bi

Mo: Element to substitute

Element: Better stabilized on Mo-edge

Element: Better stabilized on S-edge

 Edge substitution strongly preferred

 Basal plane substitution possible

Doping stability is one of the key issues

# Hydrogen Evolution Reaction on MoS<sub>2</sub>

## Can We Activate the Basal Plane?

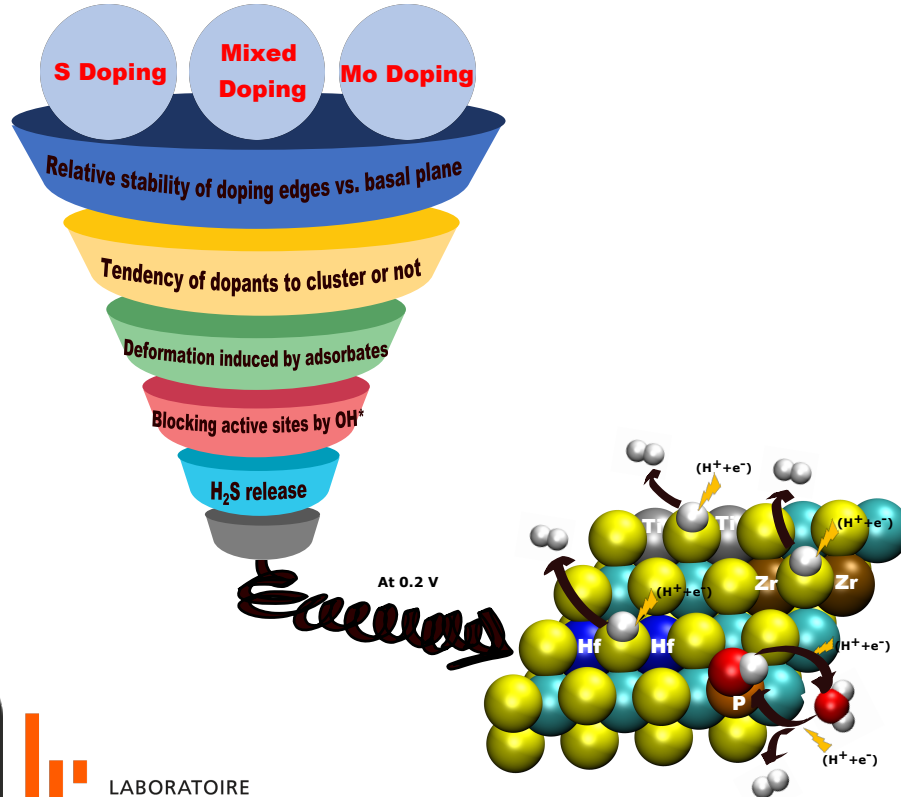

**At -0.2 V vs SHE:**  
few dopants create active sites:

Mo/P via OH/H<sub>2</sub>O cycling  
Ti<sub>2</sub>/S, Hf<sub>2</sub>/S and Zr<sub>2</sub>/S via Volmer-Heyrovsky

~1 year PhD

# Partial take home message

## Material screening

Computers are patient and non-intelligent

Strong and necessary assumptions limit the scope

Do not forget about *stability*

→ Computationally expensive and not always that useful

1. Sulfate on Au(111)

2. HER on MoS<sub>2</sub>: Screening of dopants

**3. Structural complexity**

4. Reaction pathways





# Alloy Re-Organization under Reactive Conditions

In-plane  
Island formation

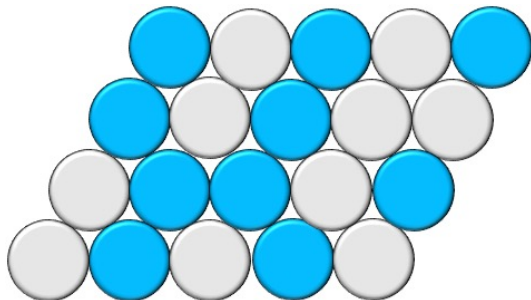

Random

Vertical  
Segregation

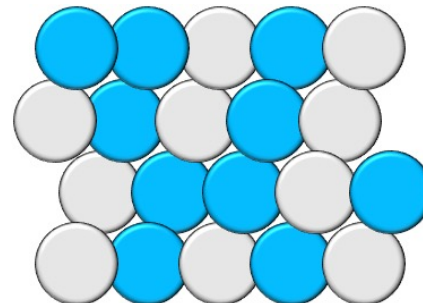

Ordered

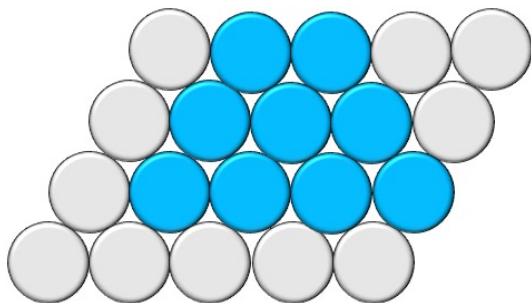
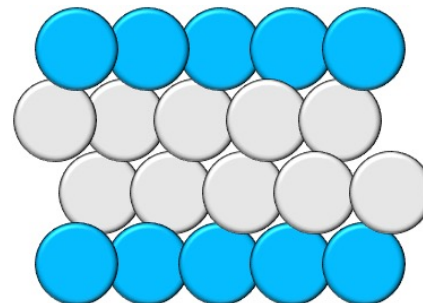



# Cluster expansion of alloy arrangement

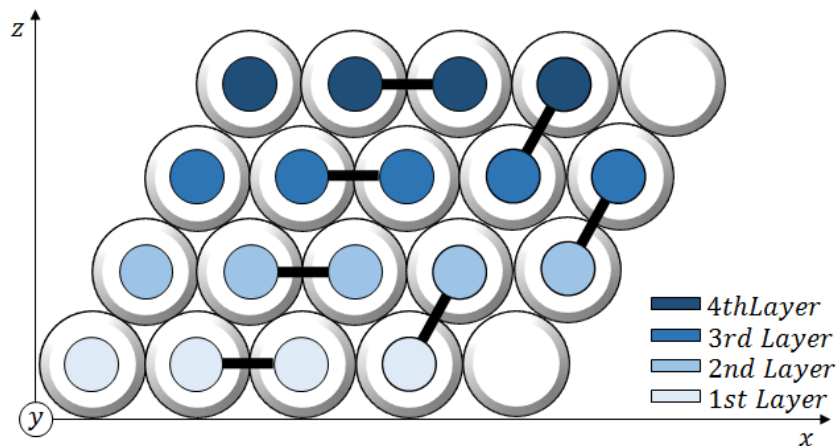

Refined model: quantitative improvement, but same trends

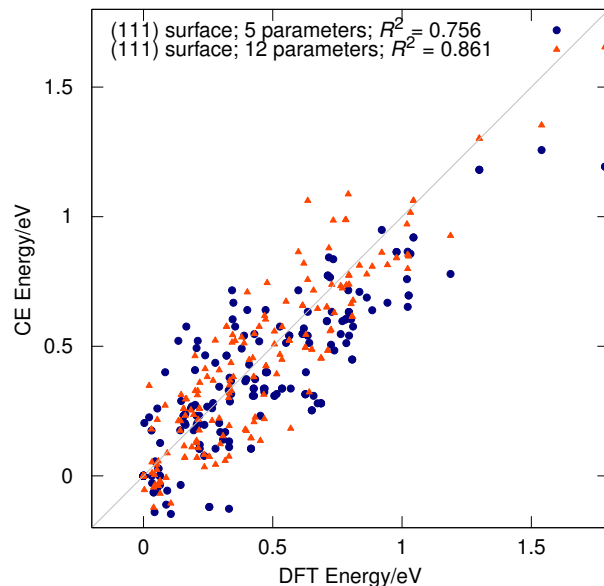

226 DFT configurations bare alloy  
 150 configurations with 1  $C_2H_2$   
 52 configurations with 2  $C_2H_2$



# Typical Configuration of $Ag_{0.76}Pd_{0.24}$ @ 1 bar of $C_2H_2$

Dense packing:

Lateral Interaction are key

**Pd:** Covered with  $C_2H_2$

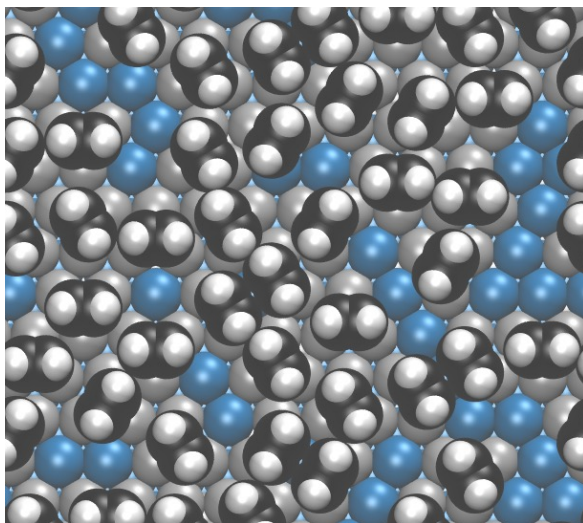

**Ag:** Acts as spacer

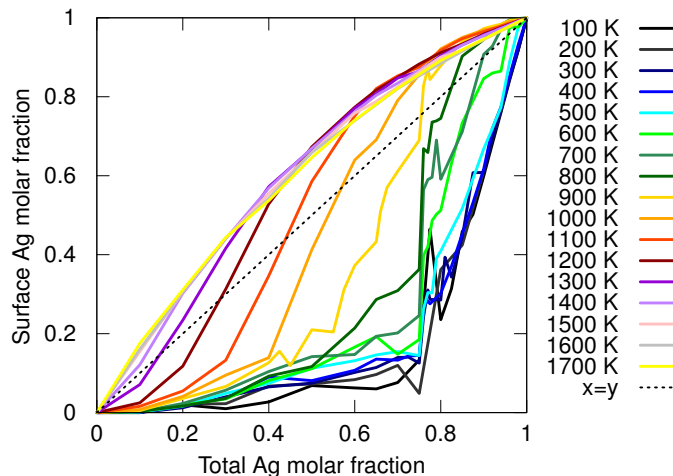

Monte Carlo simulations are required



# Typical Configuration of $Ag_{0.76}Pd_{0.24}$ @ 1 bar of $C_2H_2$

Dense packing:  
Lateral Interaction are key

Pd: Covered with  $C_2H_2$

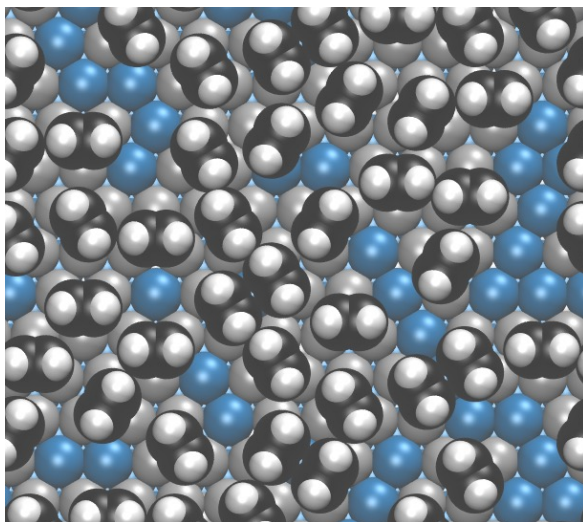

Ag: Acts as spacer

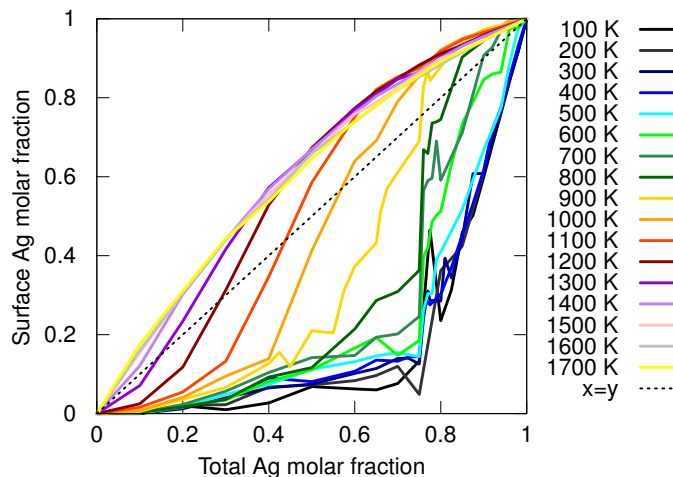

Hydrogen Evolution Reaction on MoS<sub>3</sub>

## Increasing the Number of Edge Sites?

Highly dispersed, amorphous MoS<sub>2</sub> – or – MoS<sub>3</sub> has many edge-sites

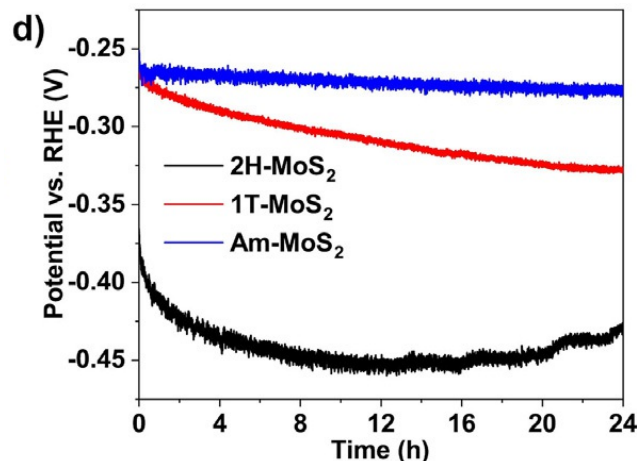

Amorphous, building block look like:

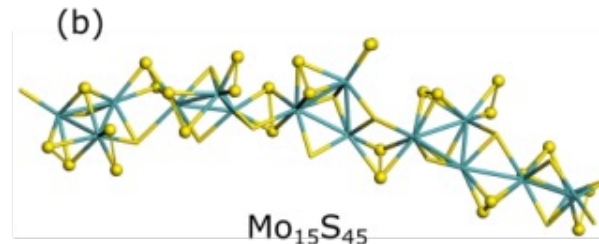
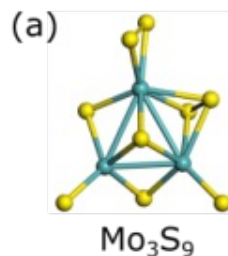

Wu, Longo, Dzade, Sharma, Hendrix, Bol, De Leeuw, Hensen, Hofmann, *ChemSusChem* **2019**, *12*, 4383.

Sahu, Steinmann, Raybaud, *Cryst. Growth Des.* **2020**, *20*, 7750.

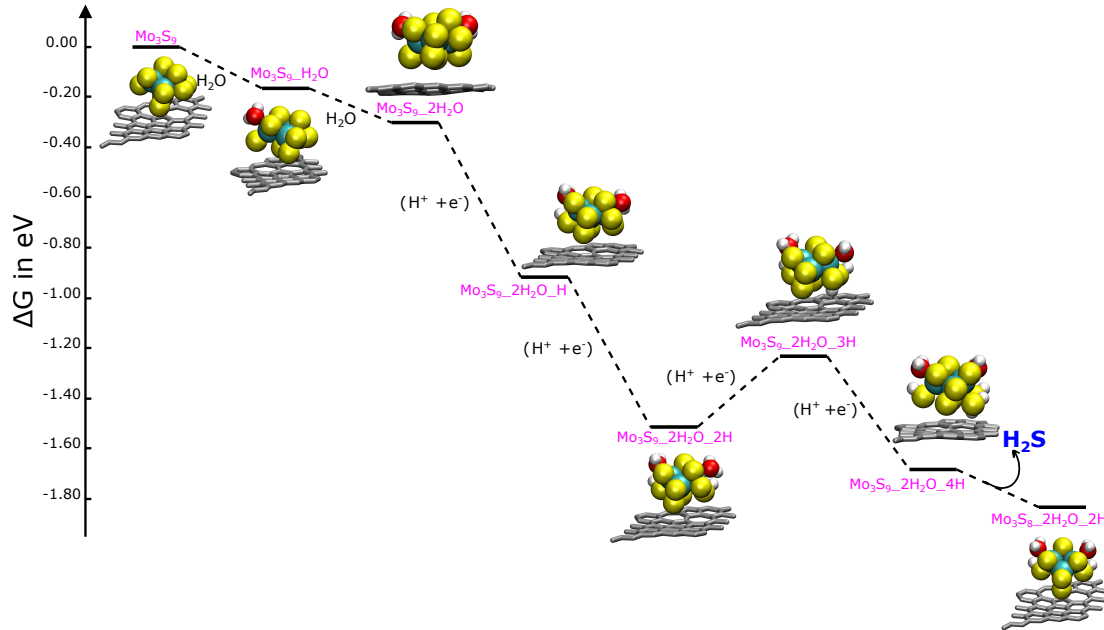
Hydrogen Evolution Reaction on  $\text{MoS}_3$ How Stable is  $\text{MoS}_3$  under HER Conditions?

~ 6 months  
post-Doc

Desorption of at least 1  $\text{H}_2\text{S}$  is easy, even at 0 V vs SHE, pH 0

# Hybrid material for oxidation of water and urea

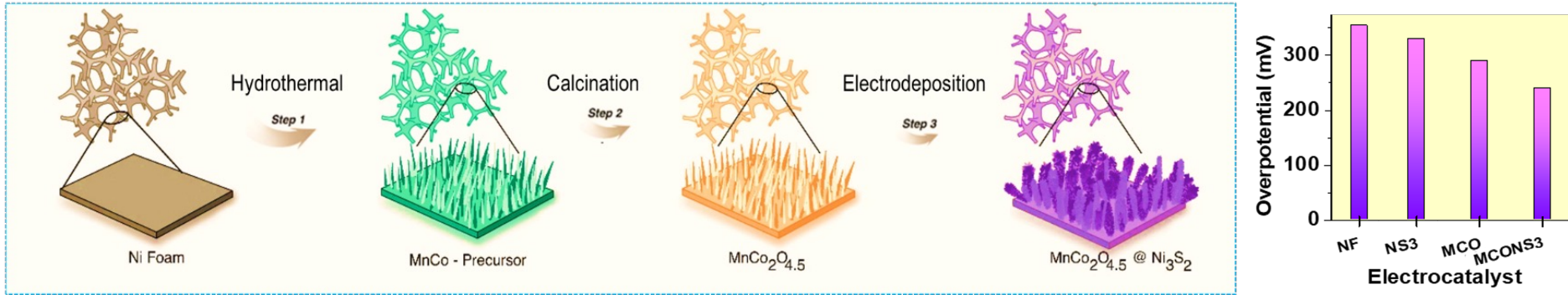

Ni foam is not very active

$\text{Ni}_3\text{S}_2$  (NS3) overlayer

manganese cobalt oxide (MCO) overlayer

Covering MCO with  $\text{Ni}_3\text{S}_2$

→ Small improvement

→ improvement

→ **even better, but why?**

## OER on hybrid material

## Reaction energy profile of OER

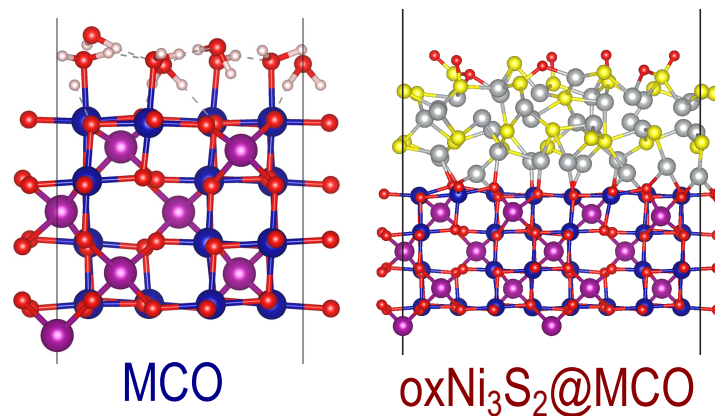
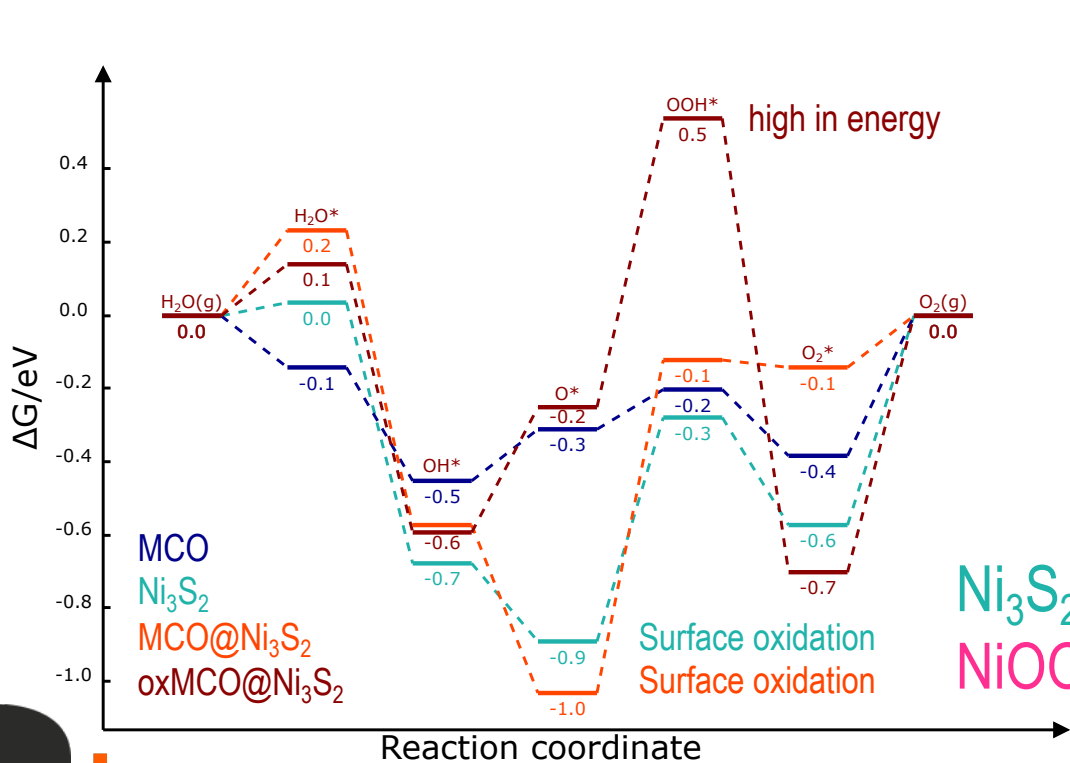

$Ni_3S_2$  is not stable under OER conditions  
 $NiOOH$  would be a better model

Conductivity and active surface area explain high experimental performance



## OER on hybrid material

## Reaction energy profile of OER

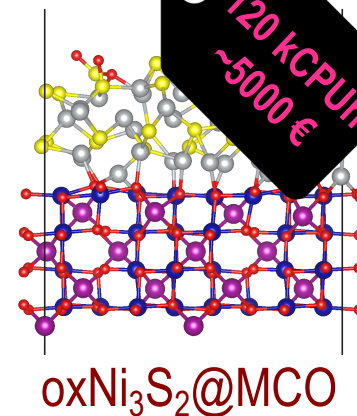
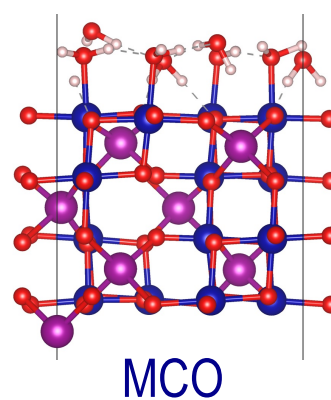
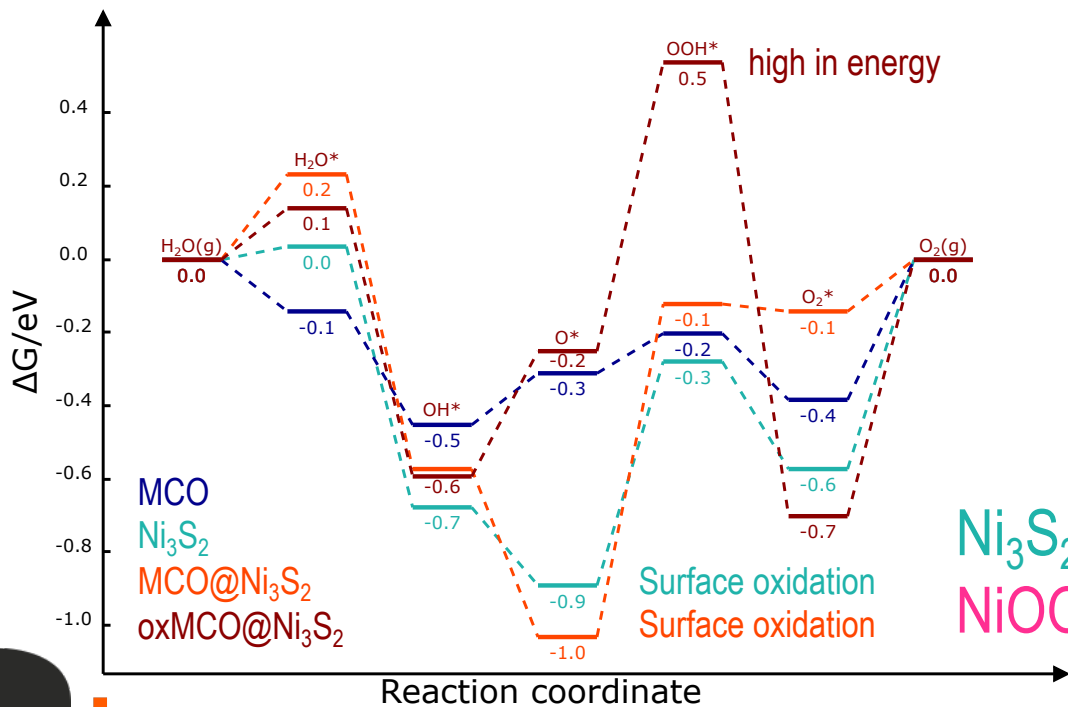

$Ni_3S_2$  is not stable under OER conditions  
 $NiOOH$  would be a better model

Conductivity and active surface area explain high experimental performance

# Partial take home message

## Structural complexity

Each system is different

Models, scope and confidence vary a lot

Amorphous structures are the worst for computational (electro-)chemists

Computations do not always lead to the expected insight

1. Sulfate on Au(111)

2. HER on MoS<sub>2</sub>: Screening of dopants

3. Structural complexity

**4. Reaction pathways**

# Revisited mechanism for alkaline OER with GC-DFT

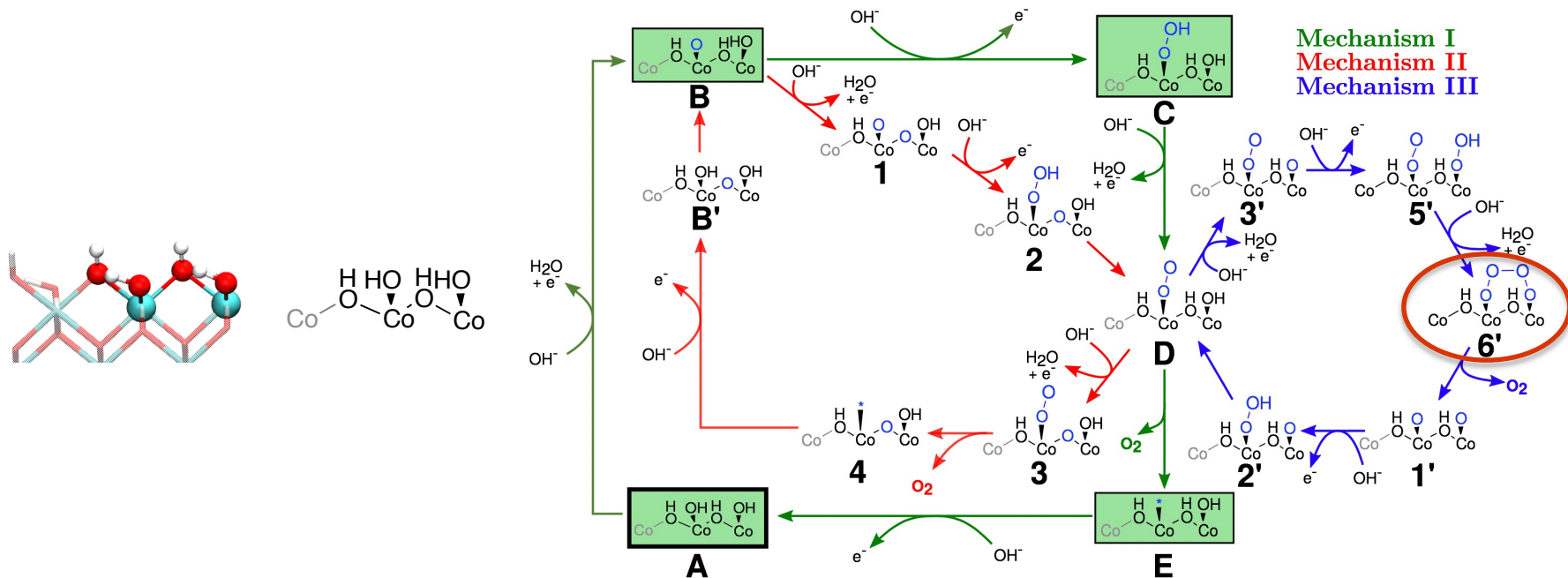

Considering barriers and overpotentials, mechanism III is likely

# Revisited mechanism for alkaline OER with GC-DFT

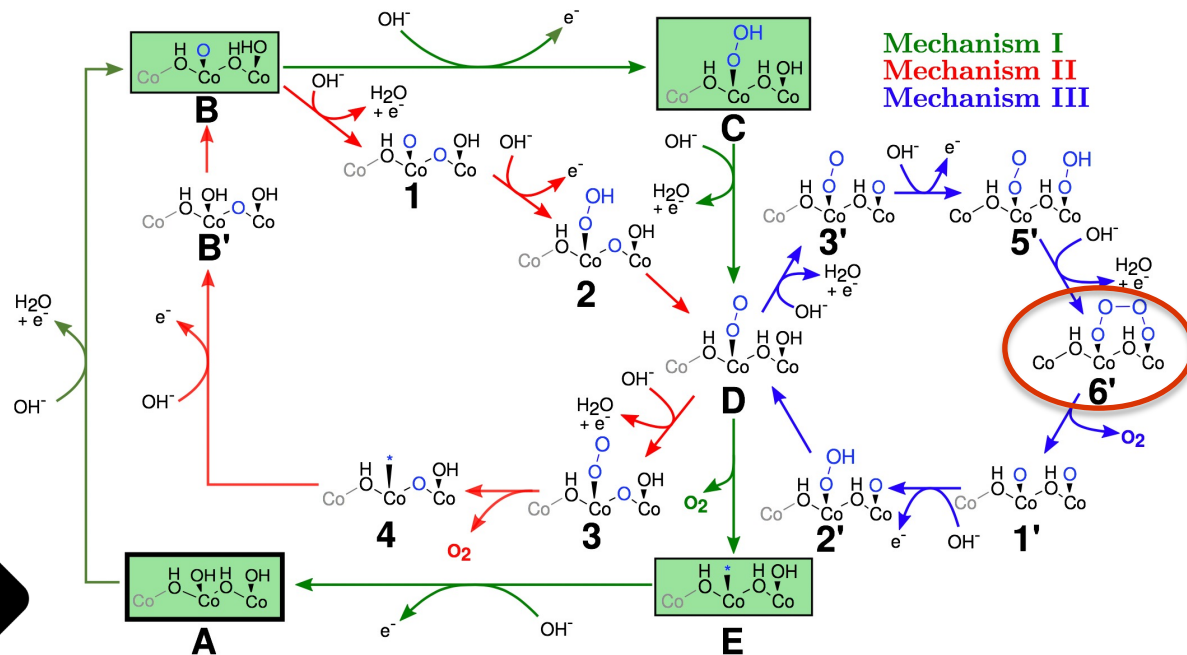
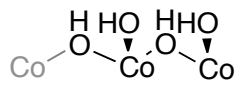
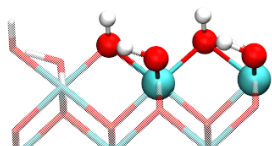

Considering barriers and overpotentials, mechanism III is likely

# HER mechanism on V<sub>S</sub> defect

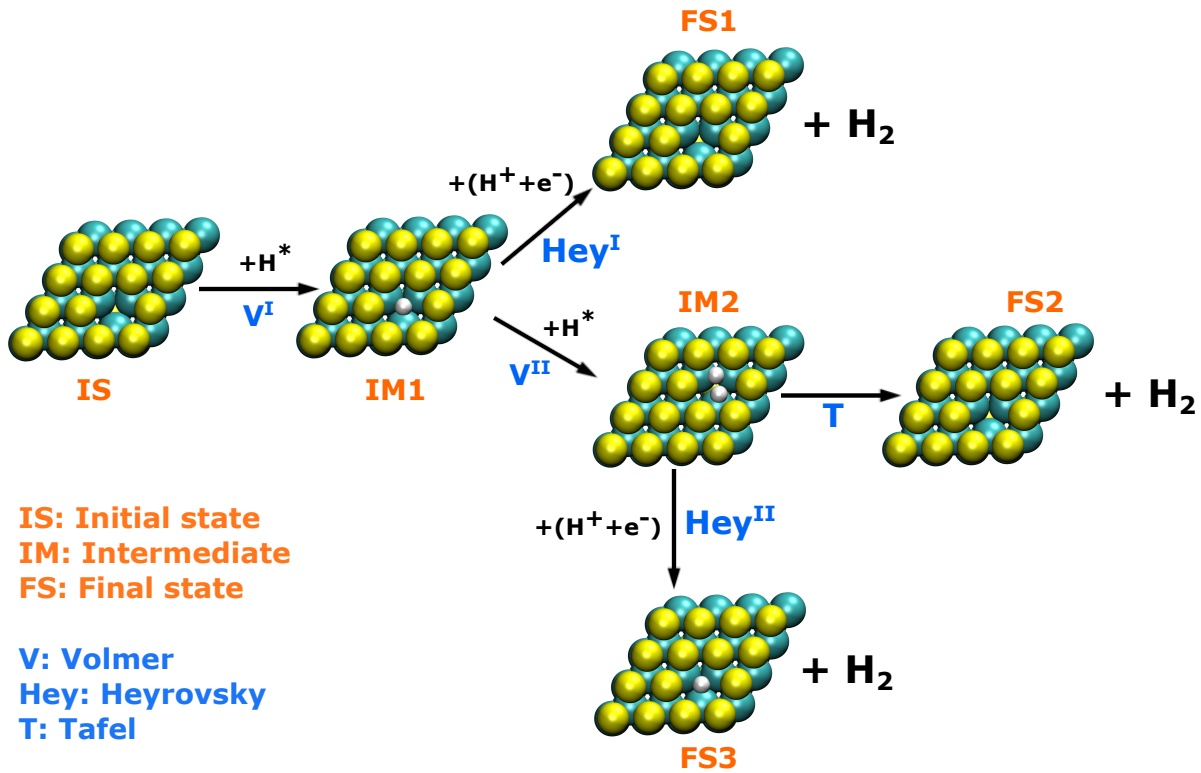

**IS:** Initial state  
**IM:** Intermediate  
**FS:** Final state

**V:** Volmer  
**Hey:** Heyrovsky  
**T:** Tafel

# Activation energies from Grand-Canonical DFT

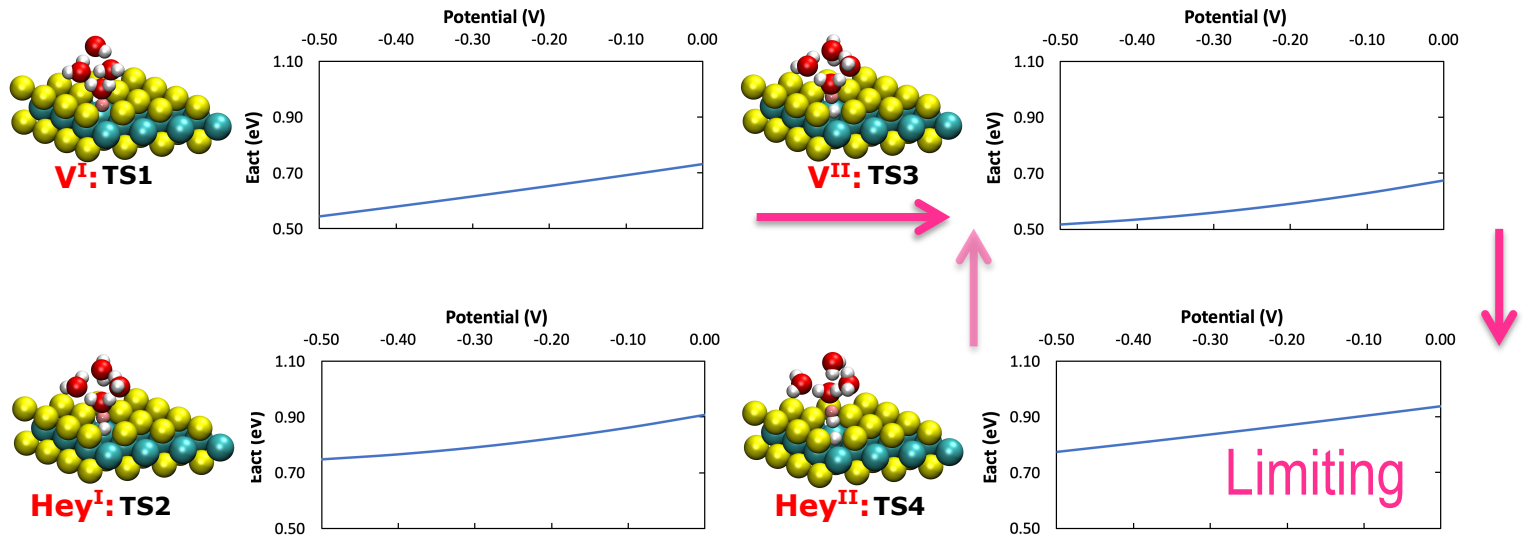

~0.8 eV barrier

**V: Volmer**  
**Hey: Heyrovsky**  
**T: Tafel**

**TS: Transition state**

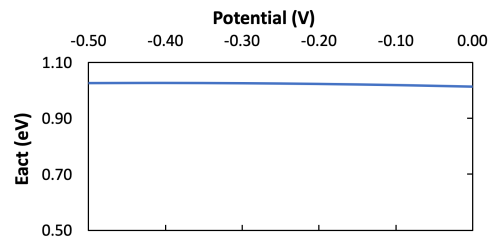
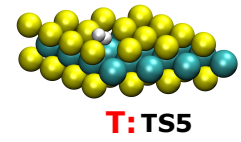

# Activation energies from Grand-Canonical DFT

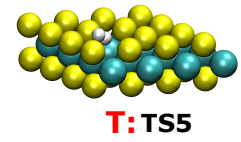
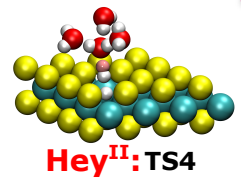
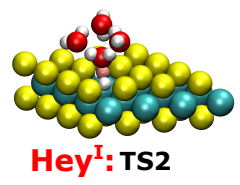
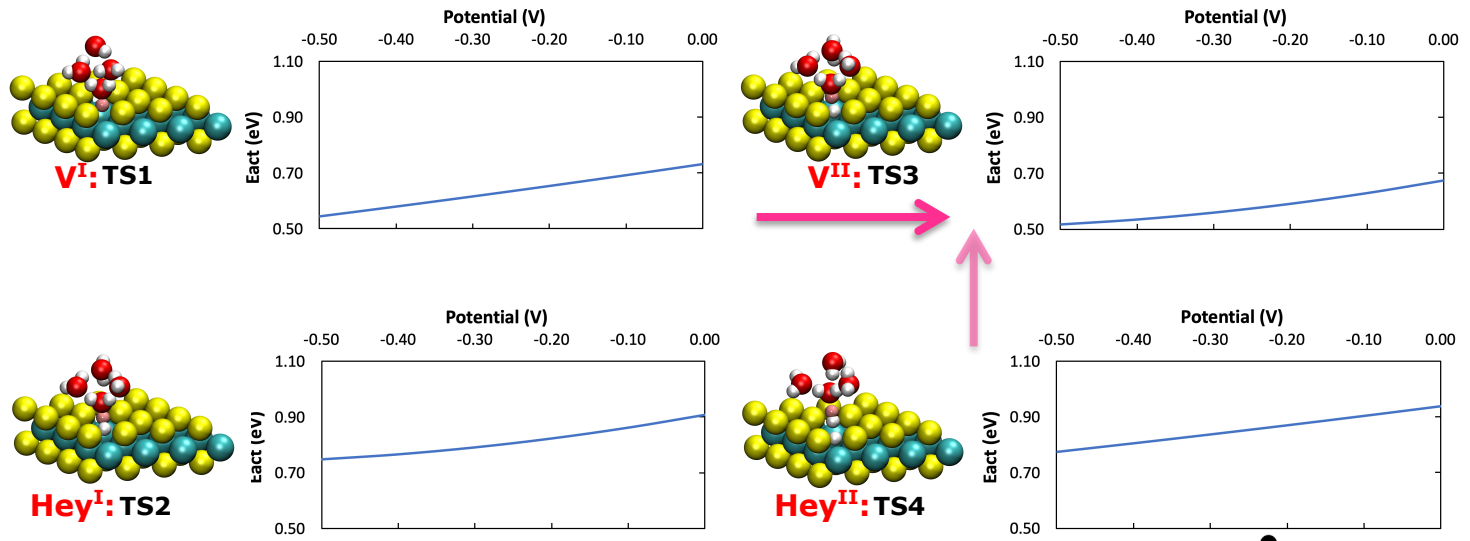

**V: Volmer**  
**Hey: Heyrovsky**  
**T: Tafel**

**TS: Transition state**

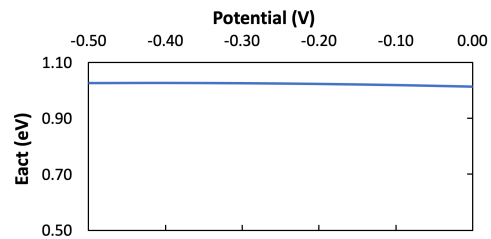



# Partial take home message

## Reaction pathways

Time consuming

Detailed insight, sometimes hard to (in-)validate by experiments

Activation energies are necessary for detailed mechanisms

Symmetry factors can be computed - but with which precision?

# Conclusions

Delicate **competition** between "chemical" vs "electrochemical" reactions

→ Can be addressed by GC-DFT



Amorphous or ill-characterized materials

→ **Structural complexity = major bottleneck**



In many cases computational studies are neither cheap nor fast



→ **Developments** are necessary for modelling solid/liquid interfaces



# Acknowledgements

## Colleagues

Carine Michel  
Tangui Le Bahers  
Paul Fleurat-Lessard  
Philippe Sautet

## PhDs and Post-Docs

Nawras Abidi  
Paul Clabaut  
Amit Sahu  
Emmanuel Vignola  
Antton Curutchet  
Yasmine Hajar  
Christopher Panaritis

## Collaborators

Elena Baranova  
Zhi Wei Seh  
Andreas Goetz





# Cluster Expansion of Adsorption Energy

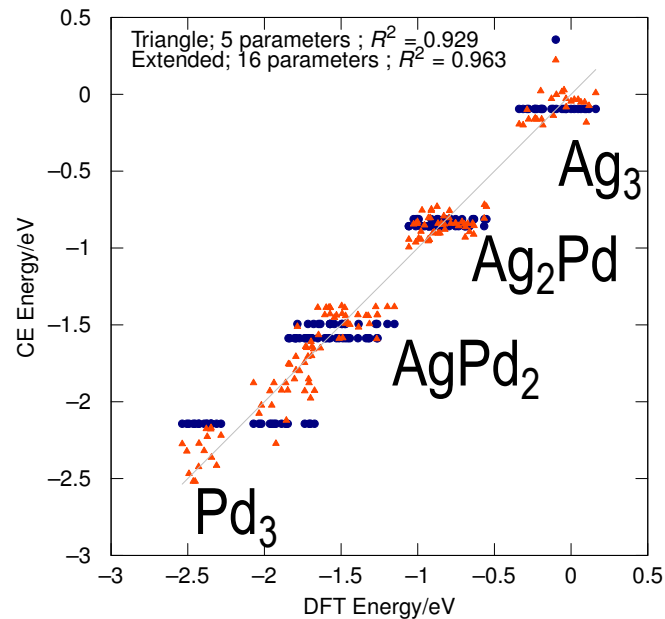
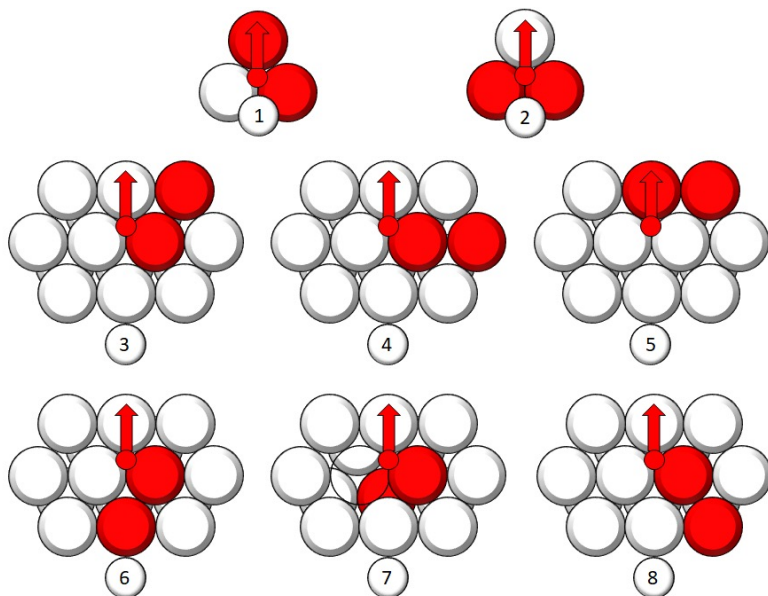

Refined model:

Spreads between ensembles is important for  $Pd_2Ag$  and  $Pd_3$

150 DFT configurations



# Cluster Expansion of Lateral Interaction Energy

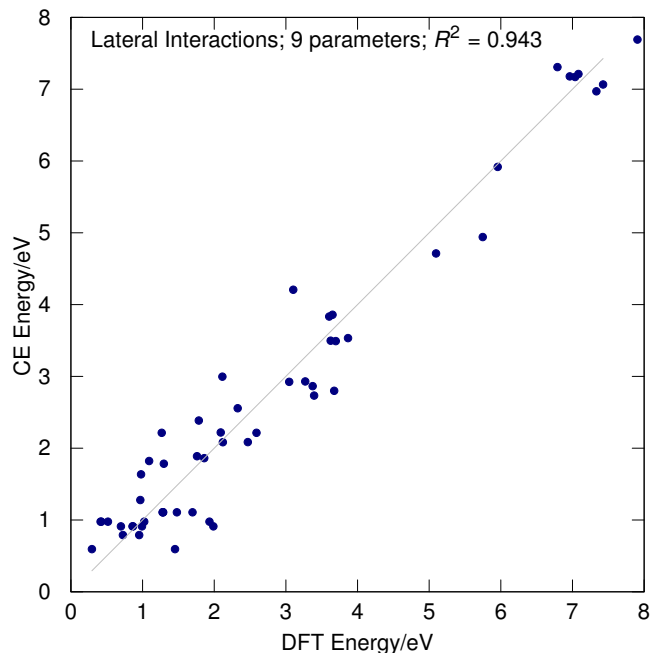
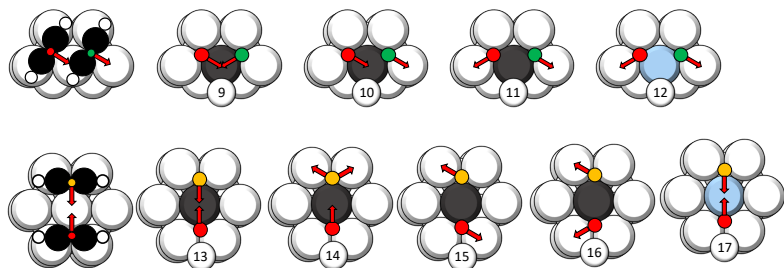
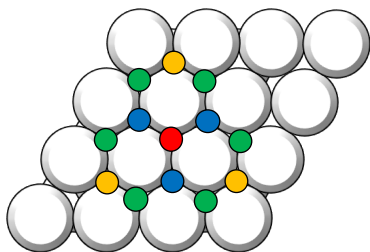

52 DFT configurations