



**HAL**  
open science

# Neutron and X-ray synchrotron large-scale facilities as major tools for science and industry

G. Chaboussant

► **To cite this version:**

G. Chaboussant. Neutron and X-ray synchrotron large-scale facilities as major tools for science and industry. EPS Forum - The 2nd EPS Forum 2024, Freie Universitat Berlin, Mar 2024, Berlin, Germany. ⟨hal-04788939⟩

**HAL Id: hal-04788939**

**<https://hal.science/hal-04788939v1>**

Submitted on 18 Nov 2024

**HAL** is a multi-disciplinary open access archive for the deposit and dissemination of scientific research documents, whether they are published or not. The documents may come from teaching and research institutions in France or abroad, or from public or private research centers.

L'archive ouverte pluridisciplinaire **HAL**, est destinée au dépôt et à la diffusion de documents scientifiques de niveau recherche, publiés ou non, émanant des établissements d'enseignement et de recherche français ou étrangers, des laboratoires publics ou privés.



HAL Authorization



# Neutron and X-ray synchrotron large-scale facilities as major tools for science and industry

**Grégory Chaboussant**  
CNRS Research Director  
[gregory.chaboussant@cnrs.fr](mailto:gregory.chaboussant@cnrs.fr)

**Laboratoire Léon Brillouin (LLB)**  
CNRS and University Paris-Saclay (France)



# Neutron and X-ray synchrotron large-scale facilities as major tools for science and industry

## Outline

- What are X-rays and Neutrons? History, production, properties
- What are they good for? Advantages and disadvantages, applications to materials and condensed matter...
- Some examples of experiments
- Conclusions and outlook

X-rays and neutrons provide two important tools for probing materials in a large range of **sizes and time scales**

**Neutron and X-ray Scattering address “small” science at “large” facilities!**

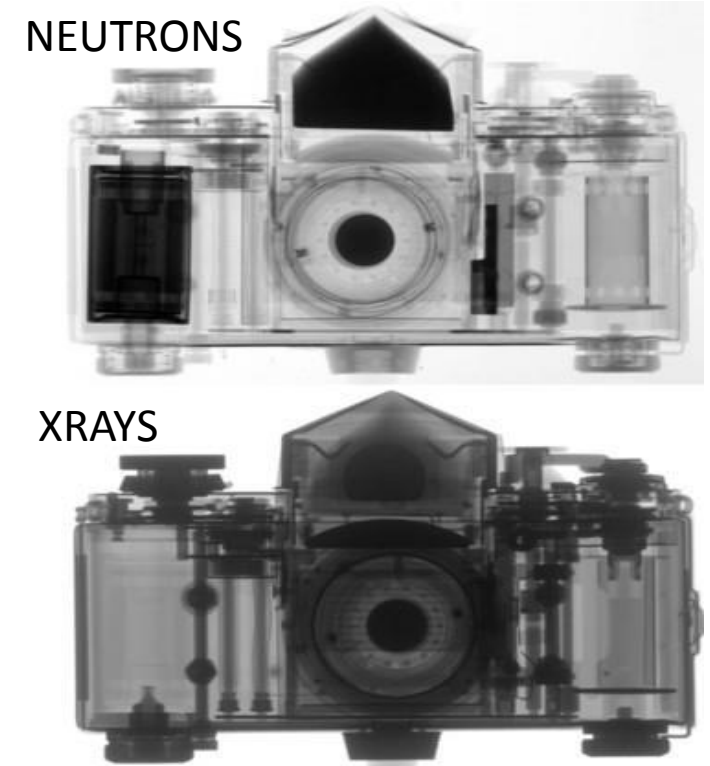

Courtesy of PSI

# Neutron and X-ray synchrotron large-scale facilities as major tools for science and industry

**What are X-rays ?**

**History, production, properties**

# X-rays : Discovery, production, properties

## Discovery of the X-rays (Röntgen, 1895)

W.C. Röntgen discovered a penetrating form of radiation able to pass through the human body: the X-rays.



**X-rays are produced by collision of electrons with a metal target** (kinetic energy loss)

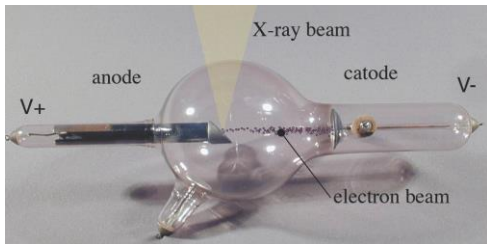
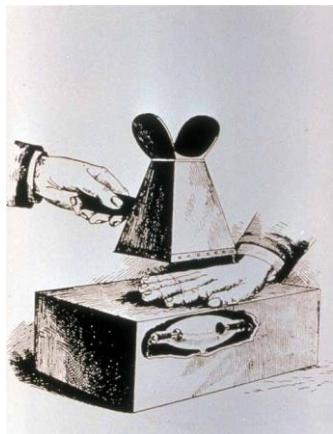

## Crystal diffraction (Van Laue 1912)

## Theory of diffraction (Bragg, 1913)

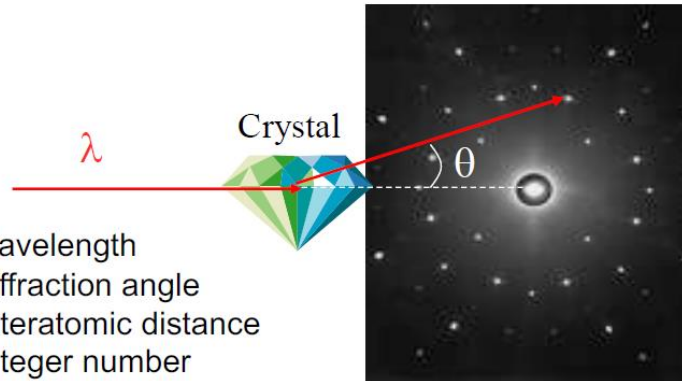

Bragg Law:  $2d \sin\theta = n\lambda$

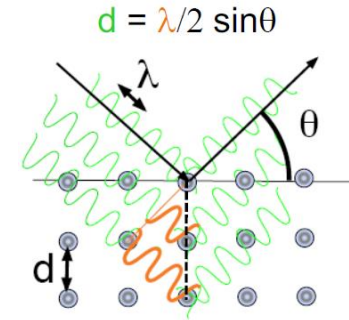

**The X-ray spectrum has two distinct components:**

- A **continuous radiation** component
- **Sharp radiations** with a characteristic energy  $K_\alpha$  and  $K_\beta$  of the metal target.
- Only 1% of the incident energy is emitted in the form of x-rays

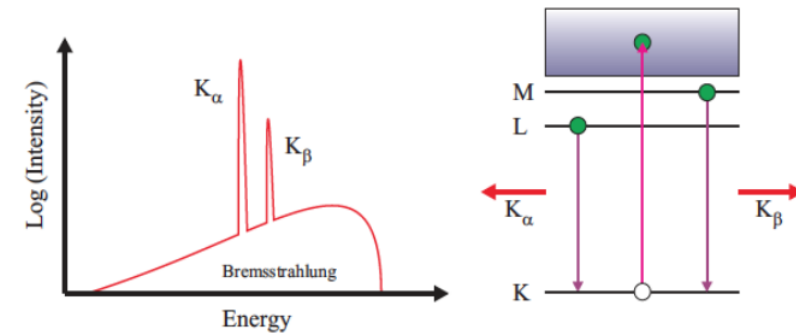

# X-rays : Discovery, production, properties

## The electromagnetic spectrum (Photons)

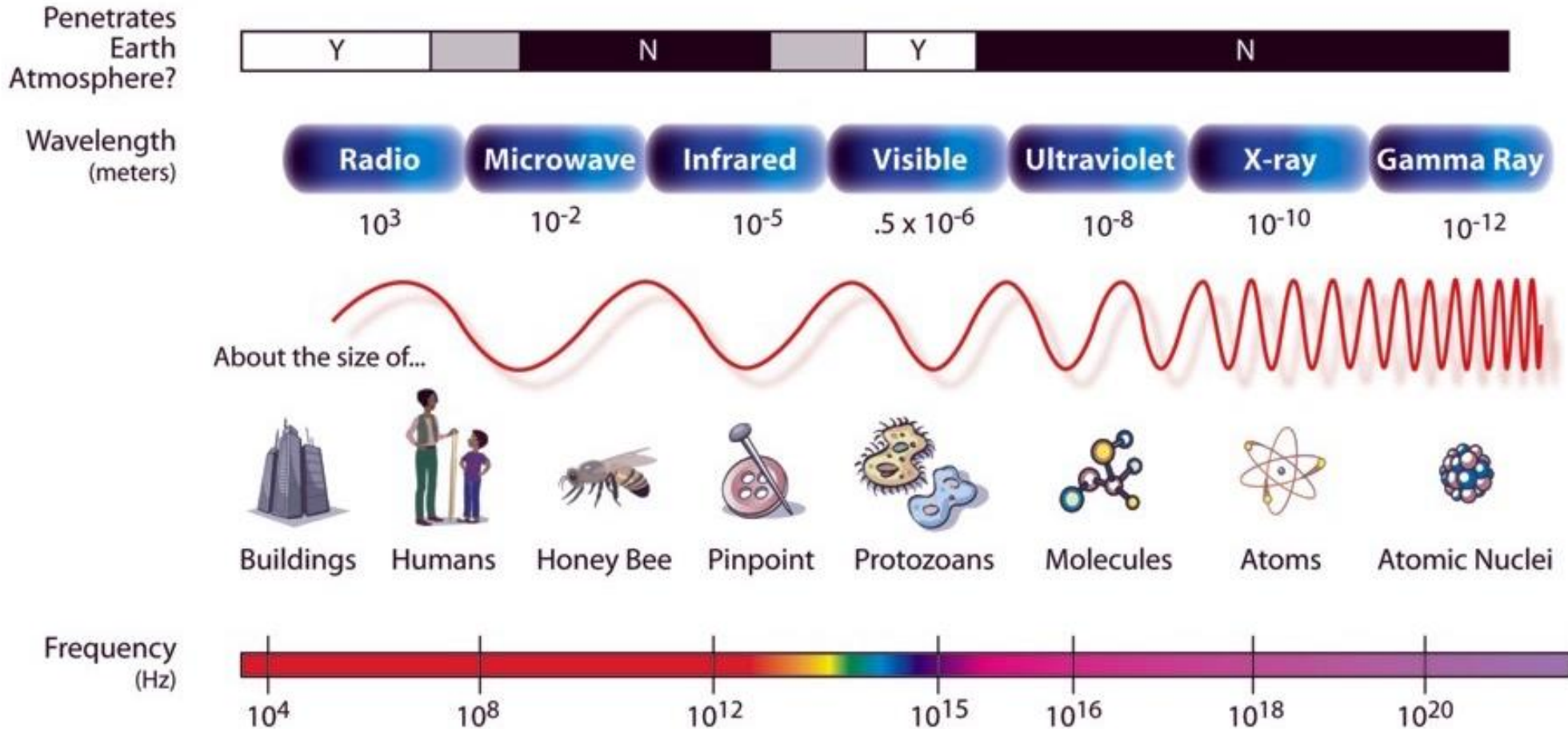

# X-rays : Discovery, production, properties

Production of X-rays : over 100 years of constant evolution and huge progress

From glass discharge anode/cathode...to synchrotron techniques and large-scale facilities

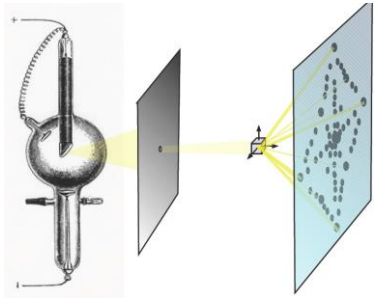

**Discovery of the Synchrotron radiation (GE, 1947)**  
 Electromagnetic radiation emitted when **charge particles** moving at **ultra-relativistic energies** are forced to change direction under the action of a magnetic field

$$E \gg m_e c^2 \sim 0.511 \text{ MeV}$$

$$\gamma = E/m_e c^2 \gg 1$$

$$\gamma \sim 1957 E[\text{GeV}]$$

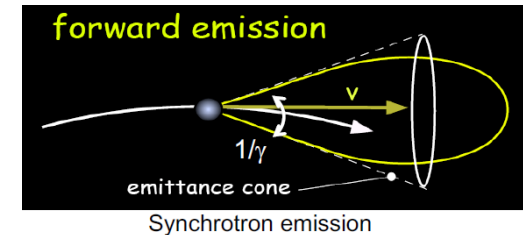

## Modern synchrotron

**Electrons** are first accelerated by a booster at high energies and then constrained on a circular orbit.

X-rays are produced by the **insertion devices** (bending magnets or undulators) and then used in the different **beamlines** located in the tangent of electron trajectory.

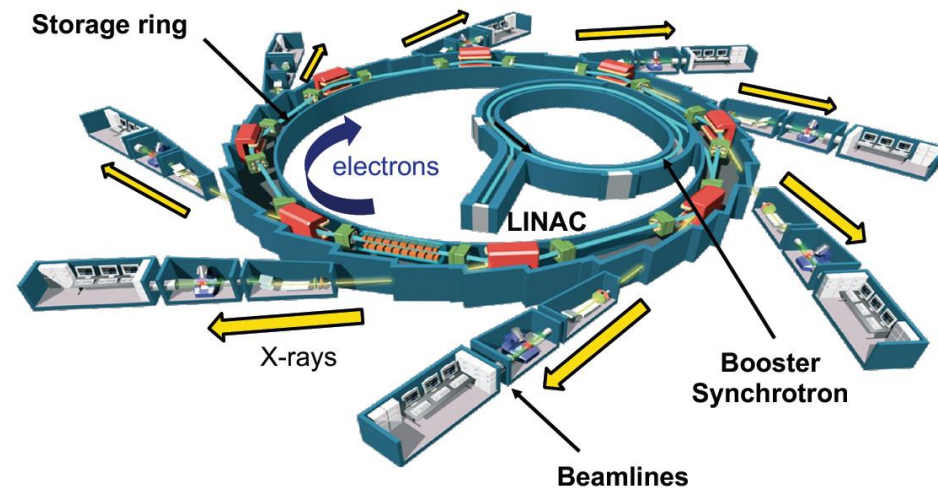

# X-rays : Discovery, production, properties

Production of X-rays : over 100 years of constant evolution and huge progress

## Synchrotron compared to standard lab Xray source

- **Higher brightness:** larger/denser samples; higher temporal resolution
- **Smaller source and further source-to-sample distance:** higher spatial resolution; smaller focused beam
- **Various pulse modes:** versatile time-resolved experiments
- **Advanced optics and detectors:** higher spatio-temporal resolution
- **Broader energy range:** elemental analysis; broader range of materials



# X-rays : Discovery, production, properties

## X rays Scattering : basic concepts

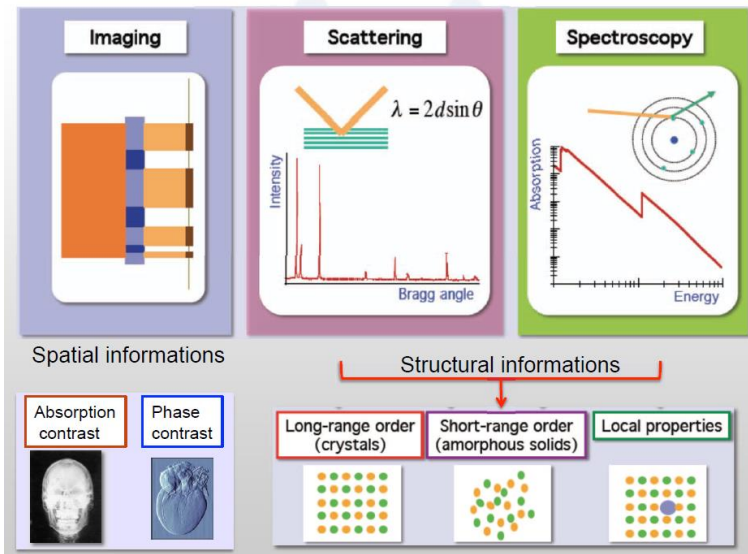
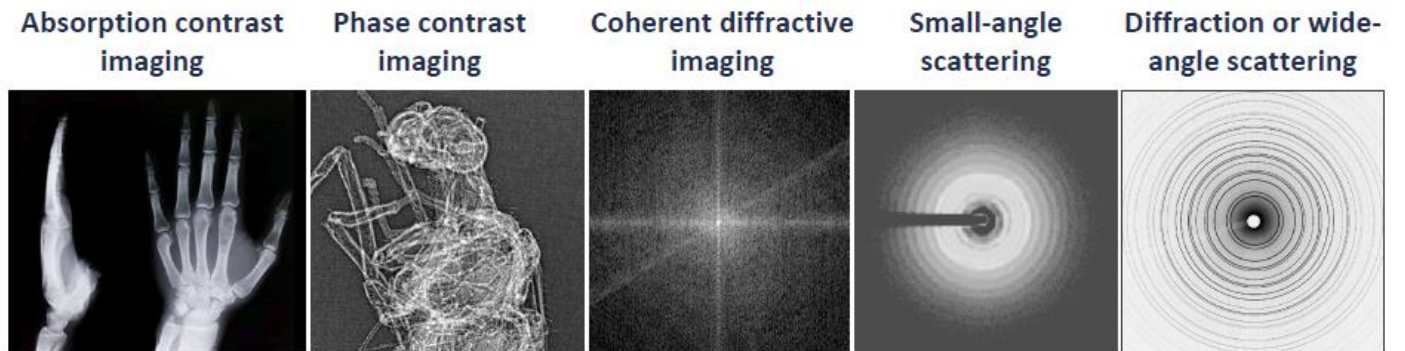
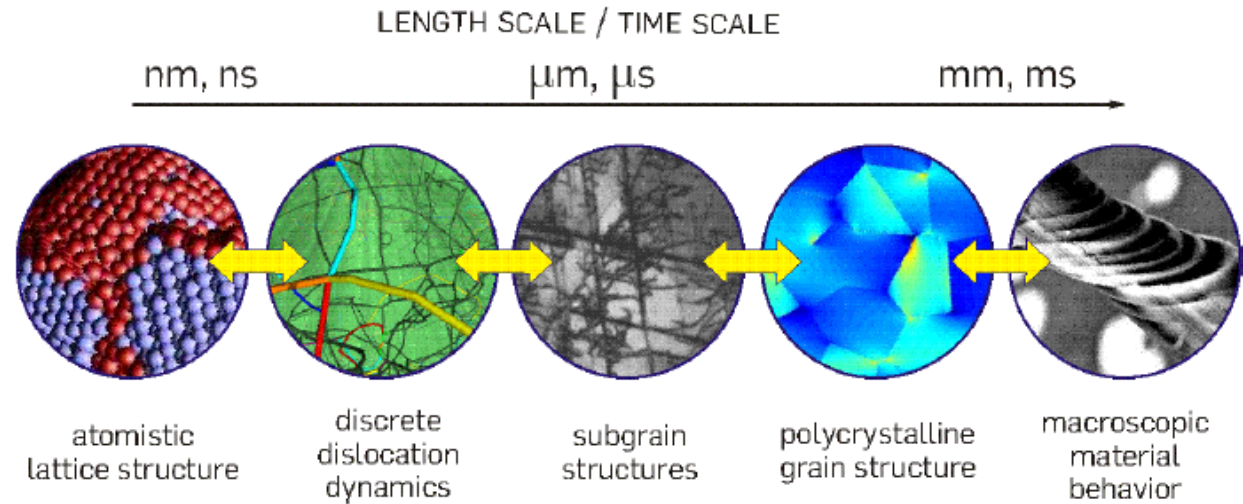
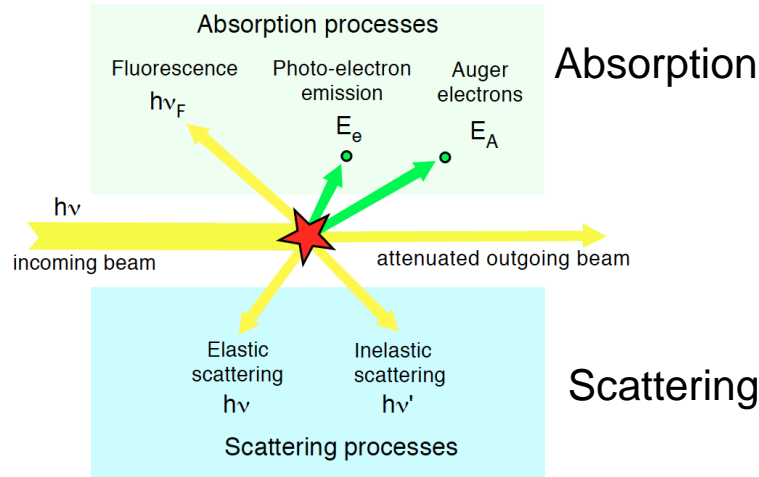

# Neutron and X-ray synchrotron large-scale facilities as major tools for science and industry

**What are neutrons?**

**History, production, properties**

# Neutrons : Discovery, production, properties

## Discovery of the neutron in 1932

1932: **J. Chadwick** (after work by others) discovers the neutron, a neutral but massive particle

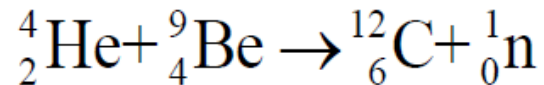
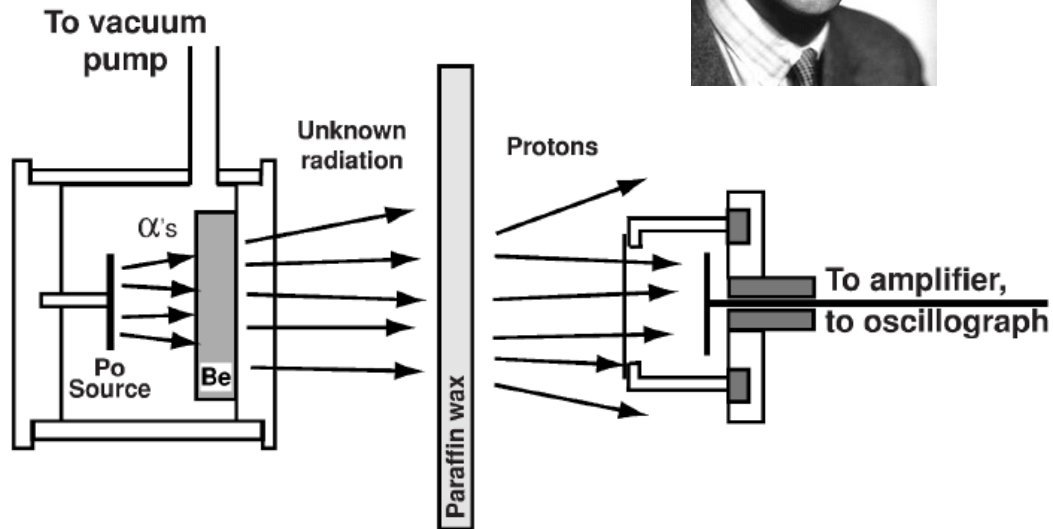

- 1938: **O. Hahn, F. Strassmann, L. Meitner** discovered the fission of  ${}^{235}\text{U}$  nuclei
- 1939: **H. v. Halban, F. Joliot, L. Kowarski** showed that  ${}^{235}\text{U}$  nuclei fission produced 2.4 neutrons on average – chain reaction.
- 1942: **E. Fermi & al.** demonstrated first self-sustained chain reaction reactor



# Neutrons : Discovery, production, properties

## Production of Neutrons : reactors, spallation, stripping

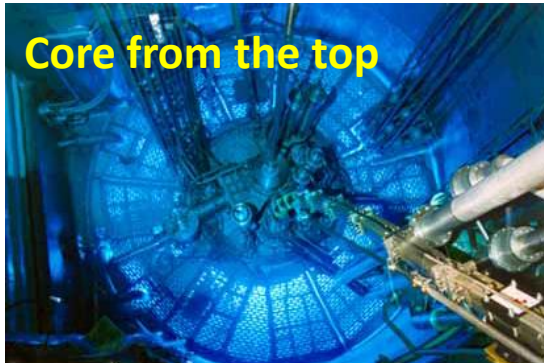

Core from the top

In the nucleus, neutrons and protons are bound together through the strong nuclear interaction. **To extract a neutron, it needs considerable energies (MeV)**

### Different processes : FUSION, SPALLATION, FISSION, STRIPPING

Common use of the neutrons: probe of materials, isotope production for medicine, bacterial sterilisation, neutron imaging, military applications...

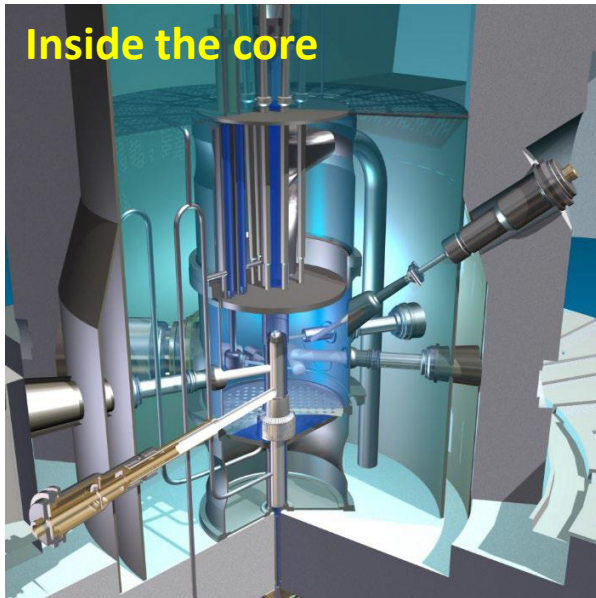

Inside the core

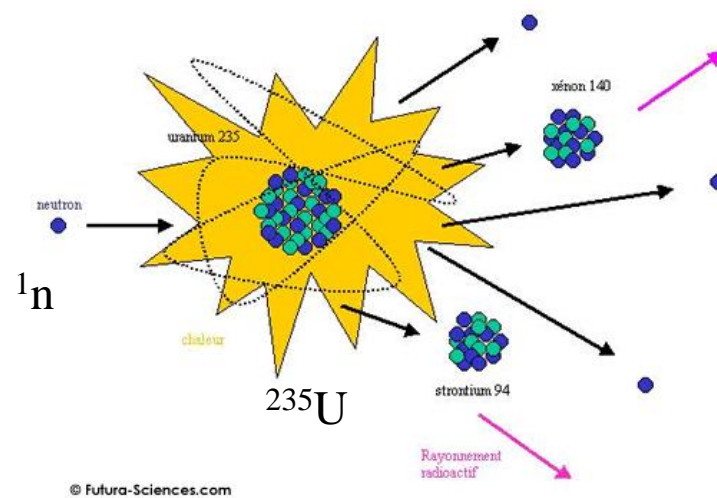

### Nuclear reaction



Neutrons must be slowed down through a « moderator » down to about 1-100 meV.

# Neutrons : Discovery, production, properties

## Properties of (thermal) Neutrons

Neutrons are massive particles

The **wavelength** of the thermal neutron is comparable to atomic sizes and lattice spacings (1-10 Å) -> diffraction, scattering

The **energy** of thermal neutrons is similar to the thermal excitations in solids (1-1000 cm-1).

Neutrons are **zero-charge particles** (-> short-range + large penetration depth)

Neutrons have a **s=1/2 magnetic moment** that interacts with the magnetic dipoles.

*Neutrons tell you “where the atoms are and what the atoms do”  
(Nobel Prize citation for Brockhouse and Shull 1994)*

**The Nobel Prize in Physics 1994**

**Neutrons reveal structure and dynamics**

*Neutrons behave as particles (and as waves)*

**The Royal Swedish Academy of Sciences has awarded the 1994 Nobel Prize in Physics for pioneering contributions to the development of neutron scattering techniques for studies of condensed matter.**

**Clifford G. Shull, MIT, Cambridge, Massachusetts, USA, receives one half of the 1994 Nobel Prize in Physics for development of the neutron diffraction technique.**

**Bertram N. Brockhouse, IBM-Knoxville Chemistry Division, Knoxville, Canada, receives one half of the 1994 Nobel Prize in Physics for the development of neutron spectroscopy.**

**S** Shull made use of elastic scattering, i.e. of neutrons which change direction without losing energy when they collide with atoms. Because of the wave nature of neutrons, a diffraction pattern can be recorded which indicates where in the sample the atoms are situated. Even the placing of light electrons such as hydrogen in specific hydroides or hydrogens, carbon and nitrogen in organic substances can be determined. The pattern also shows how atomic planes are oriented in magnetic materials, since neutrons are affected by magnetic forces. Shull also made use of this phenomenon in his neutron diffraction technique.

**B** Brockhouse made use of inelastic scattering, i.e. of neutrons, which change both direction and energy when they collide with atoms. They then start or cancel atomic oscillations in crystals and record neutrons in length and width. Neutrons can also interact with spin waves in magnets. With his 3-axis spectrometer Brockhouse measured energies of phonons (acoustic vibrations) and magnons (magnetic waves). He also studied how atomic vibrations in liquids change with time.

**Neutrons show where atoms are**

Neutrons bounce against atomic nuclei. They also react to the magnetism of the atoms.

When the neutron strikes with atoms in the crystal material, they change direction and wavelength - elastic scattering.

Atoms in a crystalline lattice

3-axis spectrometer with neutron source and neutron detector

Changes in the energy of the neutron are first analysed in an analyser crystal... and the neutrons then detected in a detector.

**Neutrons see more than X-rays**

X-rays are scattered by electrons, which are concentrated in the nucleus. Neutrons are scattered by nuclei, which are distributed throughout the volume of the atom. This allows neutrons to see through light elements such as hydrogen and carbon, which are invisible to X-rays. Neutrons also interact with magnetic dipoles, allowing them to see the arrangement of atoms in magnetic materials.

**Neutrons reveal inner stresses**

It tells the force produced in an object under load. This is done by measuring the change in the distance between the nuclei of the atoms. The neutron diffraction technique is used to measure the change in the distance between the nuclei of the atoms. This allows the force produced in an object under load to be measured.

**Neutrons show what atoms remember**

It shows what atoms remember. This is done by measuring the change in the distance between the nuclei of the atoms. The neutron diffraction technique is used to measure the change in the distance between the nuclei of the atoms. This allows the force produced in an object under load to be measured.

**There is a solution**

Thousands of neutrons are now working in the same neutron research centres throughout the world. They will continue to make important contributions to our knowledge of the structure and dynamics of matter. The neutron diffraction technique is used to measure the change in the distance between the nuclei of the atoms. This allows the force produced in an object under load to be measured.

**Further reading:**

Clifford G. Shull, *The Nobel Prize in Physics 1994*, Stockholm, Sweden, 1994. ISBN 91-7319-000-0.

Bertram N. Brockhouse, *The Nobel Prize in Physics 1994*, Stockholm, Sweden, 1994. ISBN 91-7319-000-0.

Clifford G. Shull and Bertram N. Brockhouse, *The Nobel Prize in Physics 1994*, Stockholm, Sweden, 1994. ISBN 91-7319-000-0.

# Neutrons : Discovery, production, properties

## Properties of (thermal) Neutrons

Neutrons are massive particles

The **wavelength** of the thermal neutron is comparable to atomic sizes and lattice spacings (1-10 Å) -> diffraction, scattering

The **energy** of thermal neutrons is similar to the thermal excitations in solids (1-1000 cm<sup>-1</sup>).

Neutrons are **zero-charge particles**  
(-> short-range + large penetration depth)

Neutrons have a  $s=1/2$  **magnetic moment** that interacts with the magnetic dipoles.

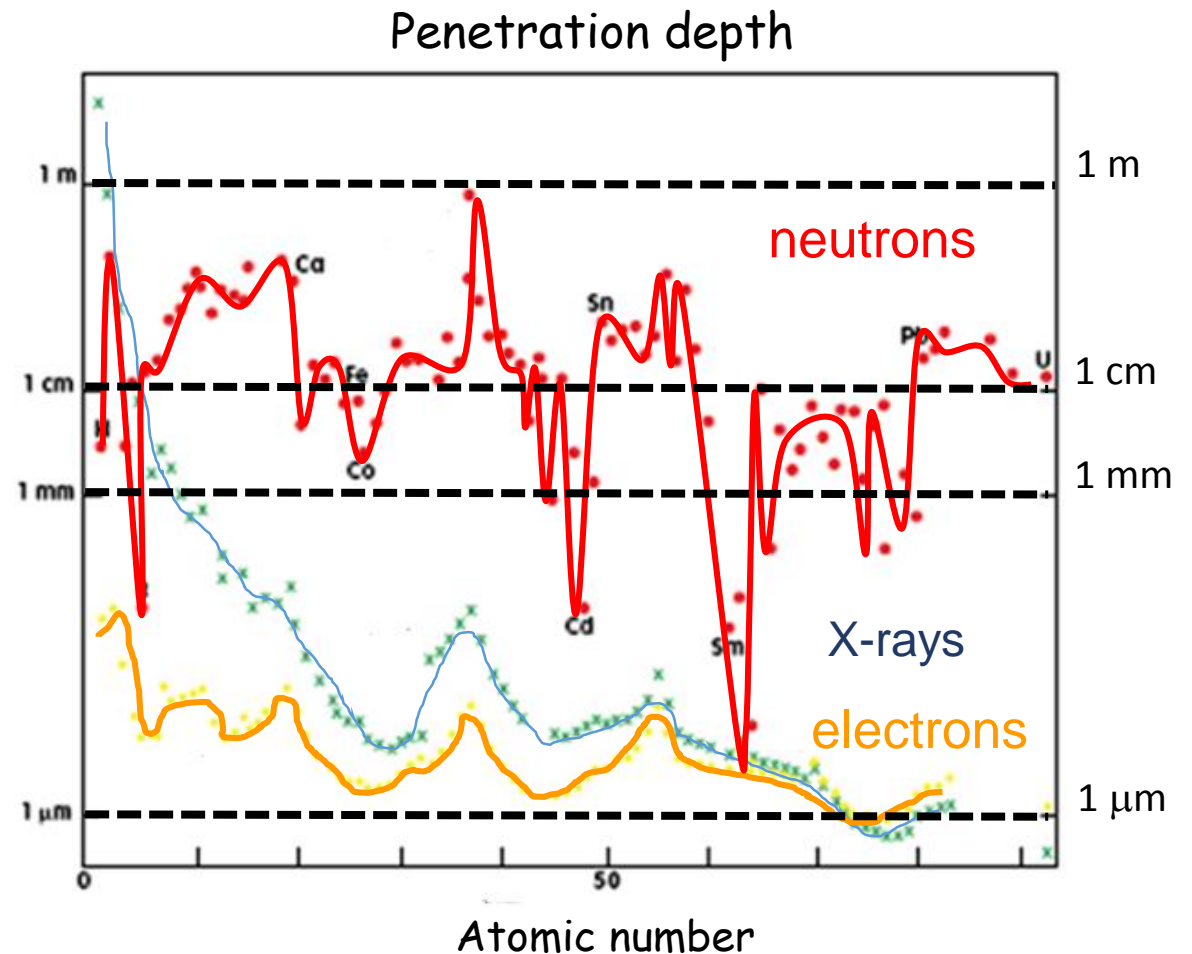

# Neutrons : Discovery, production, properties

## Properties of (thermal) Neutrons

Neutrons are massive particles

The **wavelength** of the thermal neutron is comparable to atomic sizes and lattice spacings (1-10 Å) -> diffraction, scattering

The **energy** of thermal neutrons is similar to the thermal excitations in solids (1-1000 cm<sup>-1</sup>).

Neutrons are **zero-charge particles**  
(-> short-range + large penetration depth)

Neutrons have a  $s=1/2$  **magnetic moment** that interacts with the magnetic dipoles.

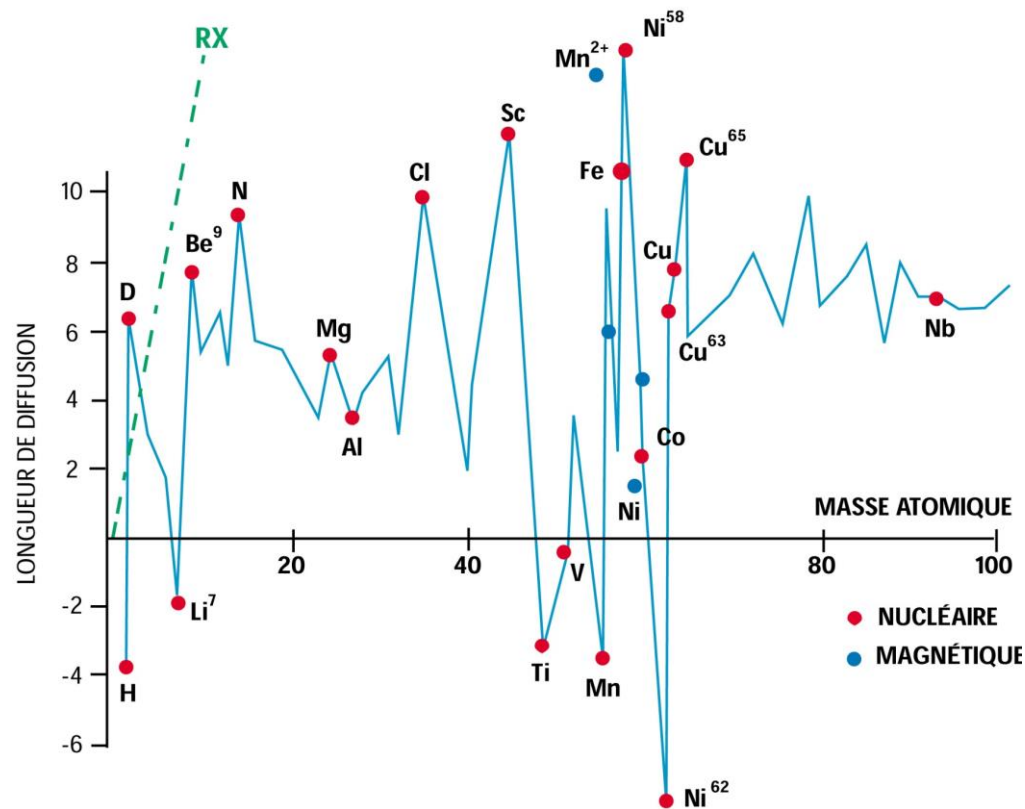

Note for neutrons:

- H/D difference, Cd, B, Sm
- no systematic Z dependence

# Neutrons : Discovery, production, properties

## Properties of (thermal) Neutrons

Neutrons are massive particles

The **wavelength** of the thermal neutron is comparable to atomic sizes and lattice spacings (1-10 Å) -> diffraction, scattering

The **energy** of thermal neutrons is similar to the thermal excitations in solids (1-1000 cm-1).

Neutrons are **zero-charge particles** (-> short-range + large penetration depth)

Neutrons have a  $s=1/2$  **magnetic moment** that interacts with the magnetic dipoles.

Scattering theory  
...not so complicated...

Huge difference with RX :  
 $\lambda = 1 \text{ \AA} \rightarrow E = 12 \text{ keV}$

$E_0 = \frac{1}{2} Mv^2 \longleftrightarrow E = k_B T$

At room temperature:  $\lambda \sim 5 \text{ \AA}$   
 Nuclear diameter  $\sim 10^{-5} \text{ \AA}$   
 Atomic spacing  $\sim \text{\AA}$

Wave-particle duality  
 $\lambda = \frac{h}{Mv}$  de Broglie (1924)

Low-energy incident wave + Point-like scatterers  
 s-wave scattering

Fermi pseudopotential:  $V(r) = \frac{2\pi\hbar^2 b}{M} \delta(r) \xrightarrow{F.T.} V = \frac{2\pi\hbar^2 b}{M}$   
 Coarse-graining:  $V = \frac{2\pi\hbar^2 \rho}{M}$

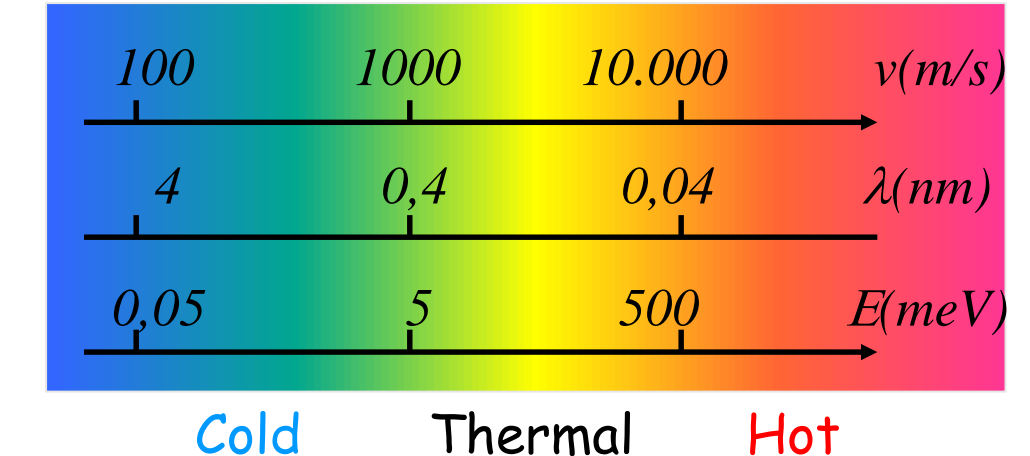

# Neutrons : Discovery, production, properties

## Neutron Scattering : experiments

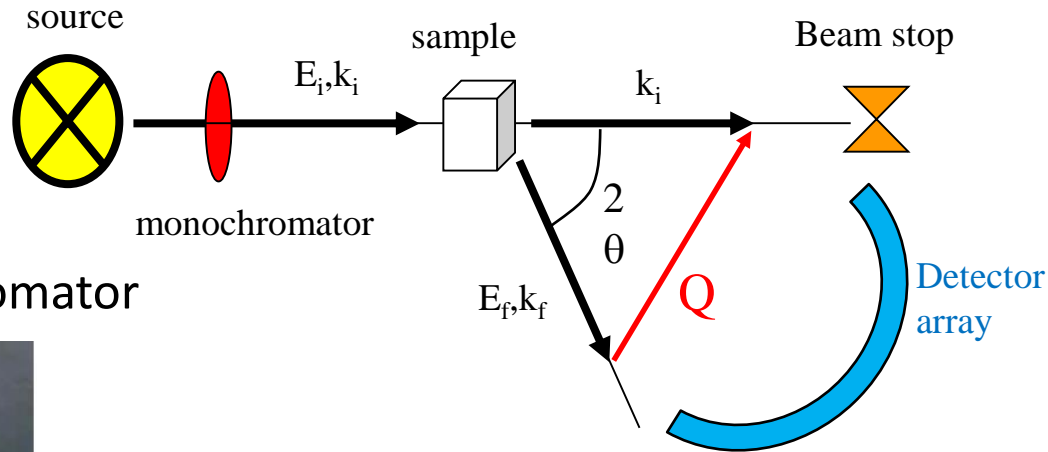

**Elastic  $E_i = E_f$**   
 Polarized Neutron Diffraction (PND)  
 Small-Angle Neutron Scattering (SANS)  
 Structures, phase transitions  
 Atomic displacements (stress, diffusion)  
 Shape/composition of nano-objects

**Inelastic  $E_i \neq E_f$**   
 Inelastic Neutron Scattering (INS)  
 Vibrations, rotations (phonons)  
 Spin-waves, solitons, spinons  
 Crystal-field excitations

Crystal monochromator

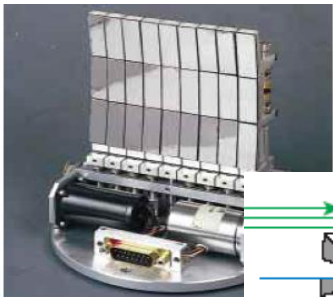

Montage à focalisation variable dans les 2 plans  
 Assemblage de cristaux plans à orientation  
 mettant de faire varier les courbures de l'en

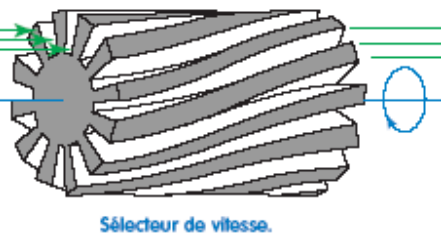

Sélecteur de vitesse.

Velocity selector



2D Detector

# Neutrons : Discovery, production, properties

## Neutron Scattering : instruments

### TYPICAL LAYOUT OF A RESEARCH REACTOR

Instruments in a « reactor hall » and « guide hall »

Diversity of instruments (« long » and « short » instruments)



- Diffractometers
- SANS, Reflectometers
- Inelastic spectrometers
- Imaging stations

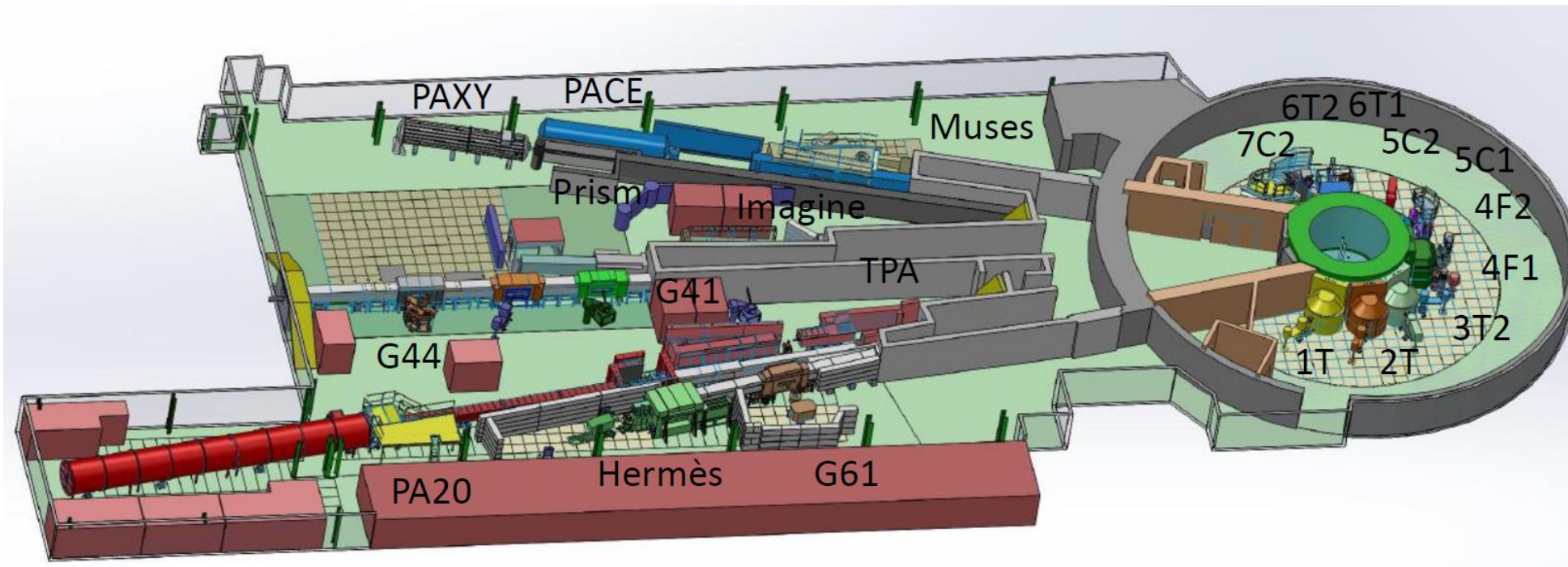

# Neutrons : Discovery, production, properties

## Neutron Scattering : instruments

**TYPICAL LAYOUT OF A SPALLATION NEUTRON SOURCE**  
 « short » and « long » instruments halls at the ESS (Sweden)



Diffractometers  
 SANS, Reflectometers  
 Inelastic spectrometers  
 Imaging stations

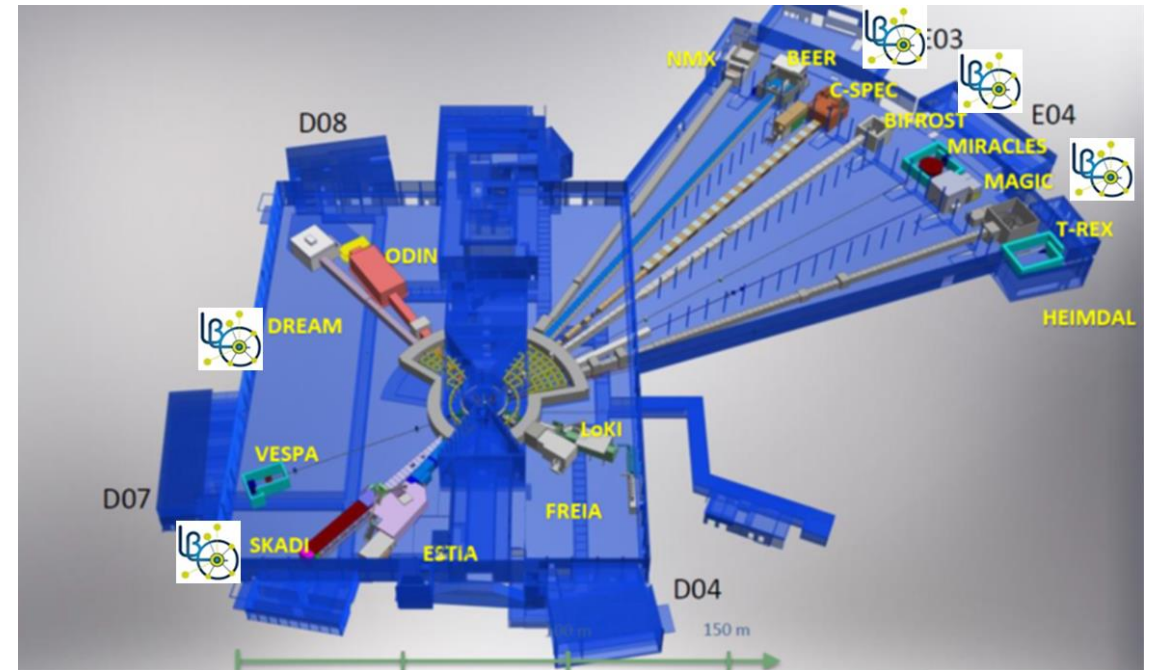

# Neutron and X-ray synchrotron large-scale facilities as major tools for science and industry

**What are they good for?**

**Advantages and disadvantages, applications  
to materials and condensed matter...**

# X-rays and neutrons: properties and capacities

Both particles are complementary and interact differently with matter

They both have Particle-Like and Wave-Like Properties

## Neutrons

$$E = \frac{1}{2} m v^2$$

Charge = 0

Mass =  $1,675 \cdot 10^{-27}$  kg

Spin =  $\frac{1}{2}$

Magnetic moment =  $-1,913 \mu_N$

Interact with nuclei via short range (~fm) forces.

Interact with unpaired electrons via magnetic dipole interaction.

## Photons

$$E = h\nu$$

Charge = 0

Mass = 0

Spin = 1

Magnetic moment = 0

Interact with electrons (electromagnetic interaction)

Interact with E/H field

- The scattering power for X-rays is proportional to the atomic number.
- The scattering power for neutrons is of the same order of magnitude for all atoms with large variations for close-by elements.

## “Scattering power”

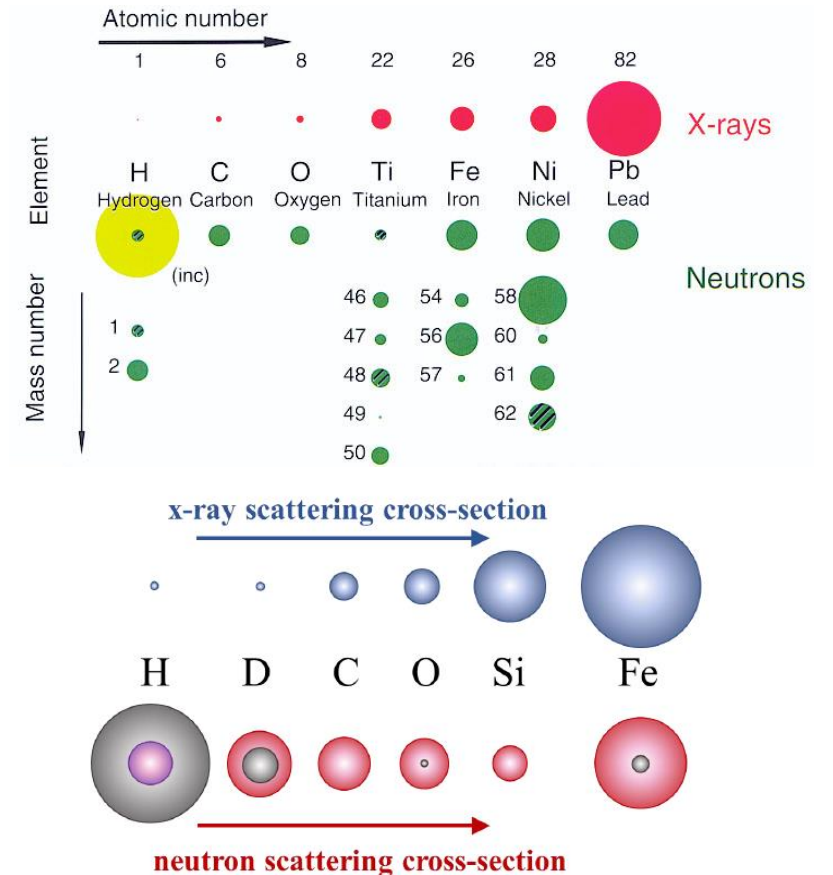

# X-rays and neutrons: properties and capacities

Both particles are complementary and interact differently with matter

## Penetration Power

	RX (1Å)	Neutrons (1.8Å)
H <sub>2</sub> O	20 cm	0.5cm
Ca	0.5 mm	60 cm
Cd	0.01 mm	0.05 mm
Pb	0.001 mm	40 cm

$$\Phi = \Phi_0 \exp(-N\sigma t)$$

$\Phi_0$  : incident flux

$N$  : number of atoms / unit volume (cm<sup>-3</sup>)

$\sigma$  : cross-section of the atom (cm<sup>2</sup>)

$T$  : thickness (cm)

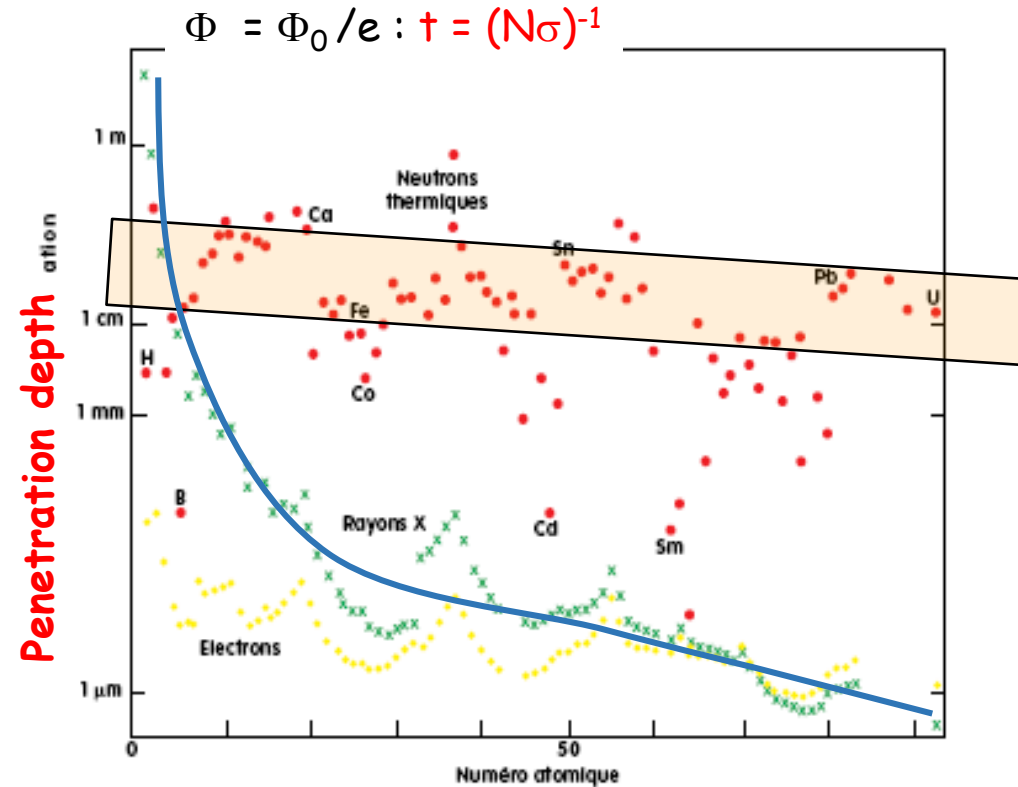

Profondeur de pénétration d'un faisceau de neutrons thermiques (0,18 nm), de rayons X (0,1 nm) ou d'électrons (0,003 nm) en fonction du numéro atomique. (Notez l'échelle logarithmique en ordonnée).

# X-rays and neutrons: properties and capacities

Both particles are complementary and interact differently with matter

**X-ray Diffraction - CuKa  
Phillips PW1710**

- Higher resolution
- Intensity fall-off at small d spacings
- Better at resolving small lattice distortions

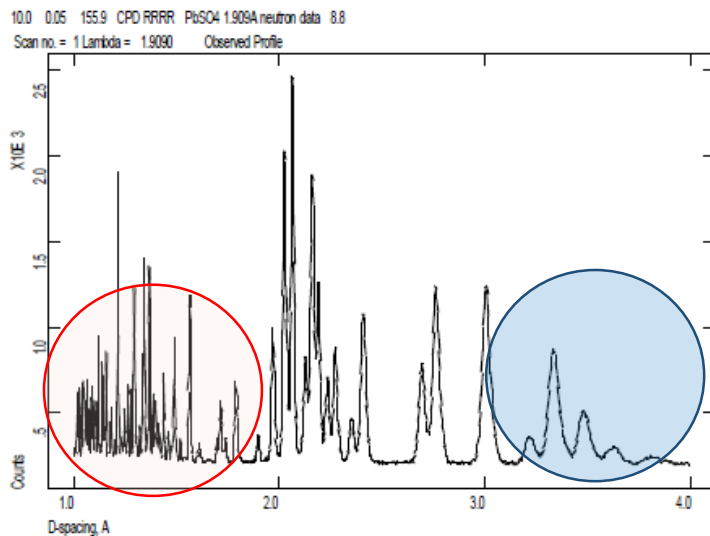
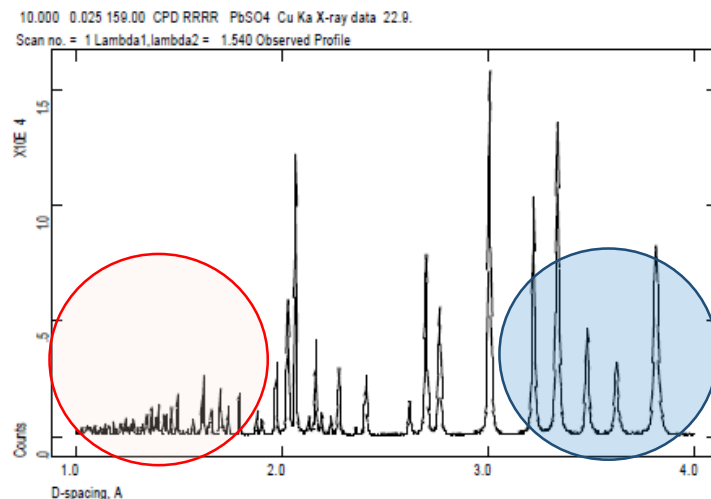

**Neutron Diffraction - D1a, ILL  
 $\lambda=1.909 \text{ \AA}$**

- Lower resolution
- Much higher intensity at small d-spacings
- Better atomic positions/thermal parameters



# X-rays and neutrons: pros and cons

- **Neutron advantages:**

Energy comparable to excitations (phonons, magnons)  
 Penetrate bulk matter (even heavy elements)  
 Scattering by nuclear potential and magnetic fields comparable  
 Weak interaction with matter -> first Born approximation  
 Isotopic sensitivity allows contrast variation (H/D)  
 Neutrons do not destroy your sample (low flux)

- **Neutron disadvantages**

Neutron flux is “weak” : low signals, need for large samples  
 Some elements (Cd, B, Gd) absorb strongly  
 Kinematic restrictions in energy and momentum transfers  
 Maximum energy limited in general to 1-2 eV

- **X-rays advantages**

Lab sources available!  
 High brilliance x-ray sources (coherence, small beams)  
 No kinematic restrictions (Q and E not coupled)  
 Almost no restriction on energy transfers  
 Separation of orbital and spin components possible

- **X-rays disadvantages**

Strong absorption of low energy photons  
 Contrast issues (low contrast for similar elements)  
 Radiation damage to samples  
 Magnetic scattering is weak except at resonances  
 Energy resolution limited

# « two-facility » sites in Europe

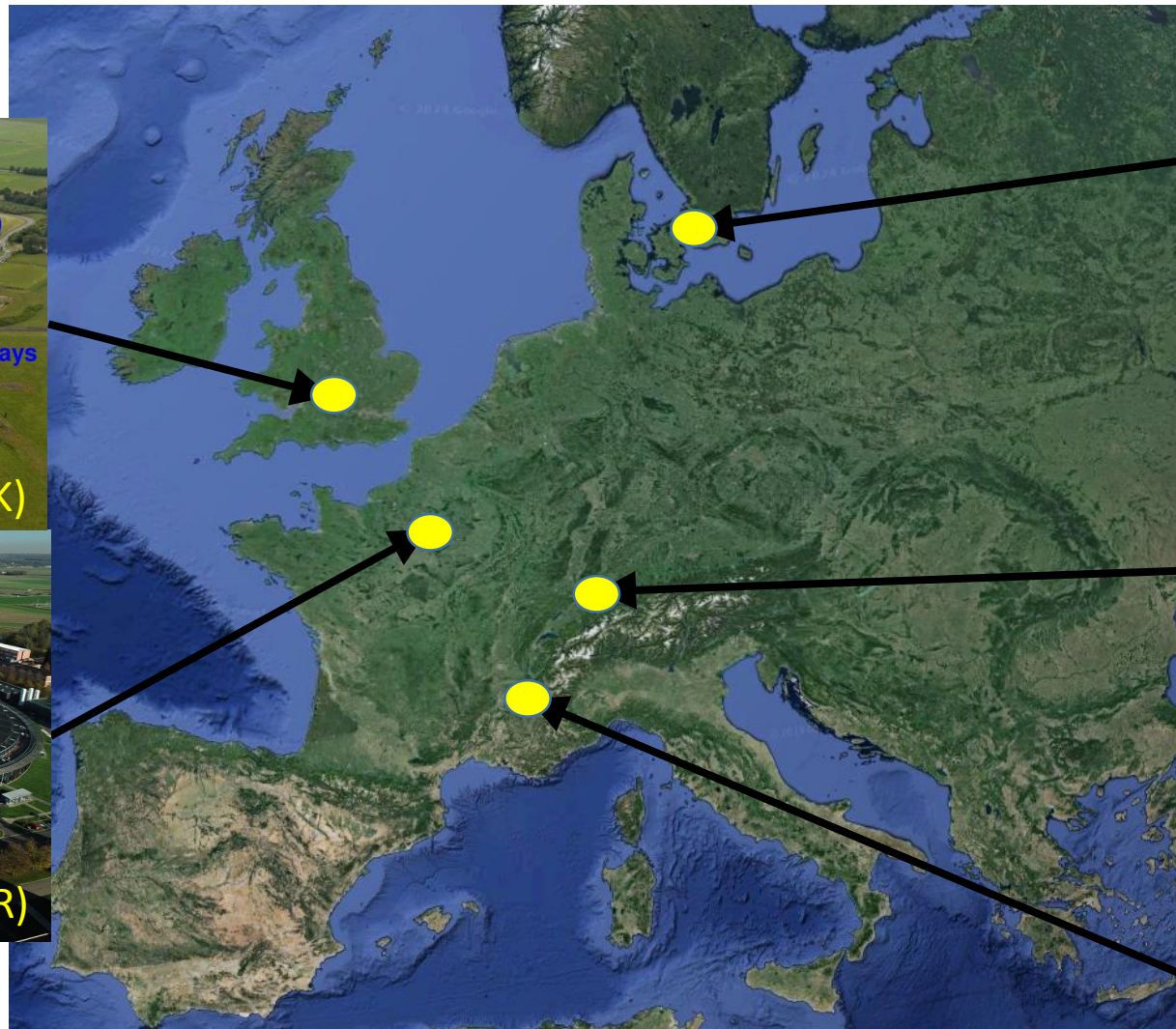
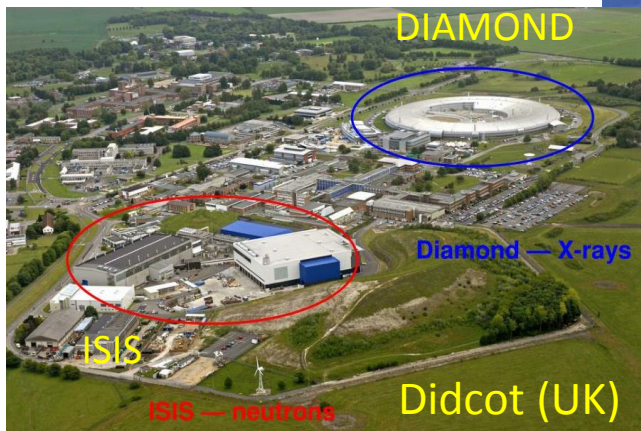

Other facilities (SR or Neutron) in Germany, Spain, Italy, Netherlands, Hungary

# Neutron and X-ray synchrotron large-scale facilities as major tools for science and industry

## **Some examples of fine experiments :**

- **Structure determination**
- **Imaging**
- **Small-angle scattering**
- **Magnetic scattering**

# X-rays and neutrons: some highlights

## Diffraction techniques

**Neutron Diffraction yields structural information:** lattice constants, atomic positions, atomic displacement factors, occupations, space group symmetry, stress and strain

**Take home message :**

- sensitive to the nuclei position
- contrast of scattering lengths
- isotope effect
- isotropic scattering

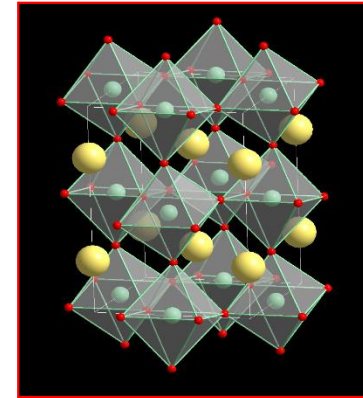

Perovskite Structure

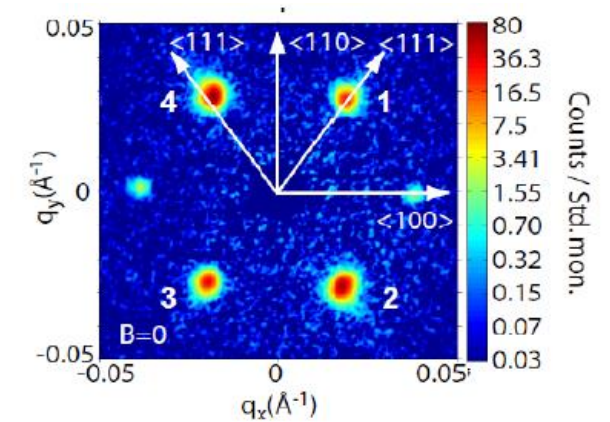

2D lattice of Syrmions

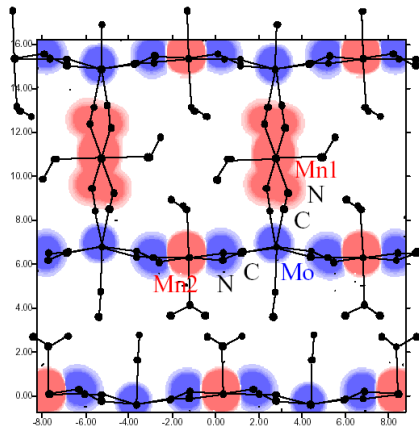

Spin-density mapping in Mn(CN)Mo

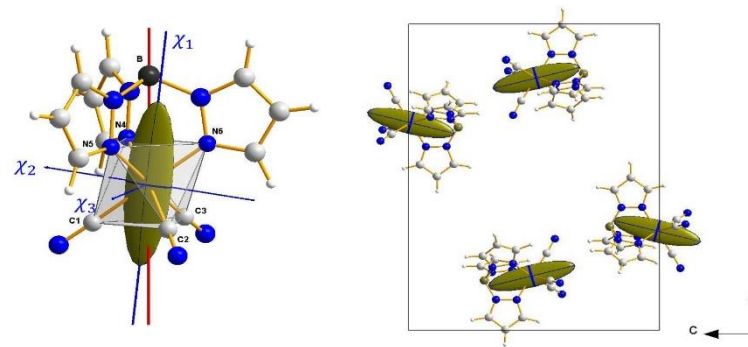

Magnetic Anisotropy Tensor in Fe<sup>III</sup>Tp(CN)<sub>3</sub>

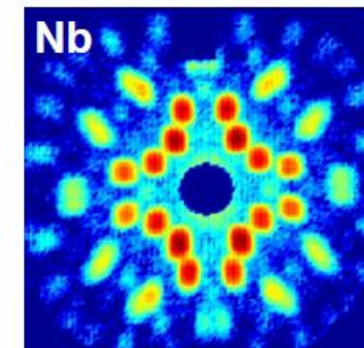

Flux line lattice in superconducting Nb

# X-rays and neutrons: some highlights

## Small angle scattering (SANS and SAXS)

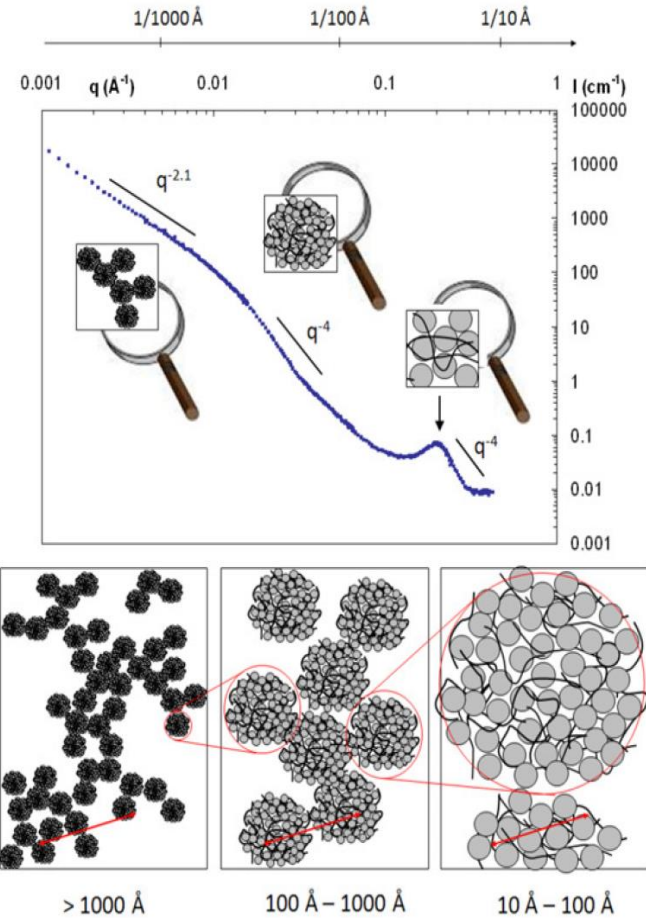

@ Fabrice Cousin (LLB)

### Diffraction at the nanoscale !

1 nm – 1 μm lengths scales

- **Individual shape of nano-objects** (molecules, nanoparticles, polymers, proteins, etc.) and **complex fluids**
- **Collective behaviour** nanostructures, complex systems, aggregation, crystallization
- **Microstructures** in metals and alloys (phase segregation, diffusion)
- **Electronic and magnetic objects** (vortices in superconductors, complex magnetic lattices, skyrmions states)

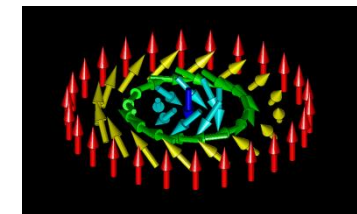
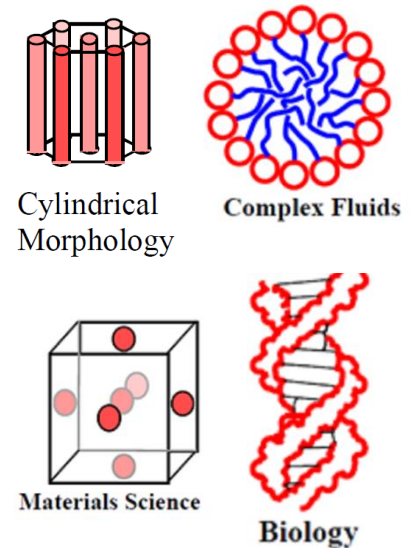

# X-rays and neutrons: some highlights

## Small angle scattering (SANS and SAXS)

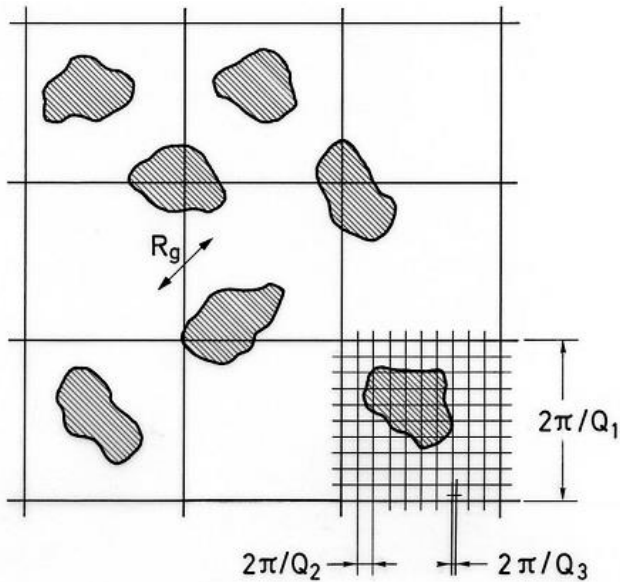

$$I_{\text{nucl}}(Q) \propto N(\Delta\rho)^2 F_N^2(Q) S(Q)$$

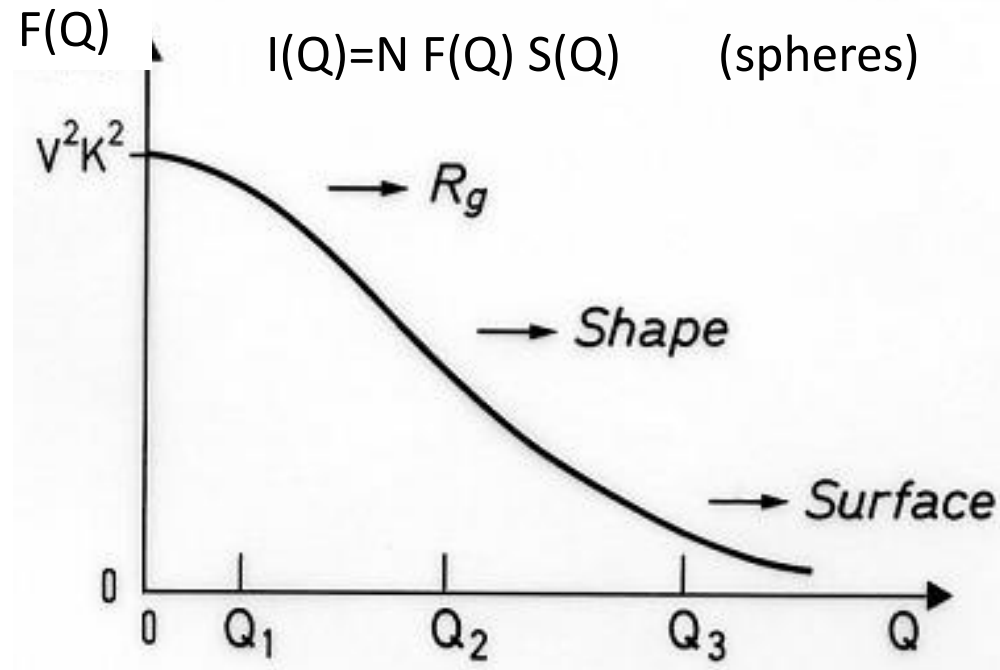

Several distinct regimes:

- 1)  $Q \approx$  object size
- 2)  $Q \approx$  object shape
- 3)  $Q \approx$  object surface variations

$Q \sim (2\pi/d)$  : SANS probes objects of size «d»

$Q = (4\pi/\lambda) \sin \theta$  : necessity to access «small angles»  $\theta$

# X-rays and neutrons: some highlights

## Neutron Scattering : SANS

### CONTRAST MATCHING IN SOFT MATTER

3-phase system

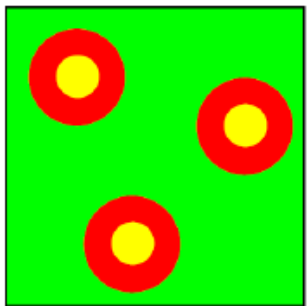

Natural contrast

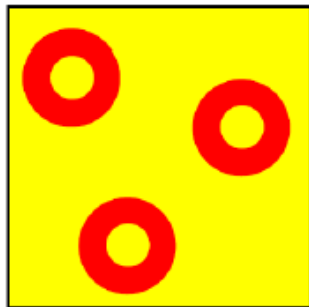

Shell visible

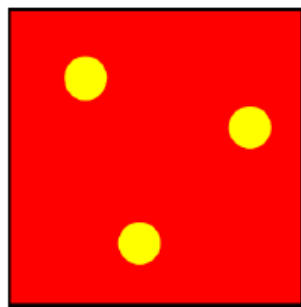

Core visible

Magic of neutron scattering lengths !!

CONTRAST MATCHING  
CONTRAST VARIATION

Micelles with spherical core ( $R=20\text{nm}$ )  
with grafted polymers ( $R_g=5\text{nm}$ )

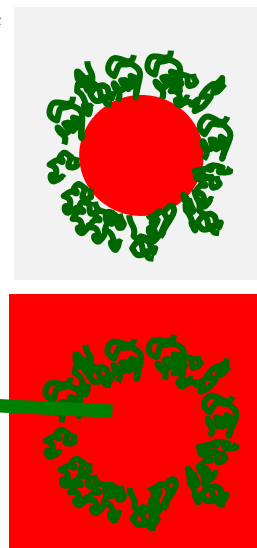
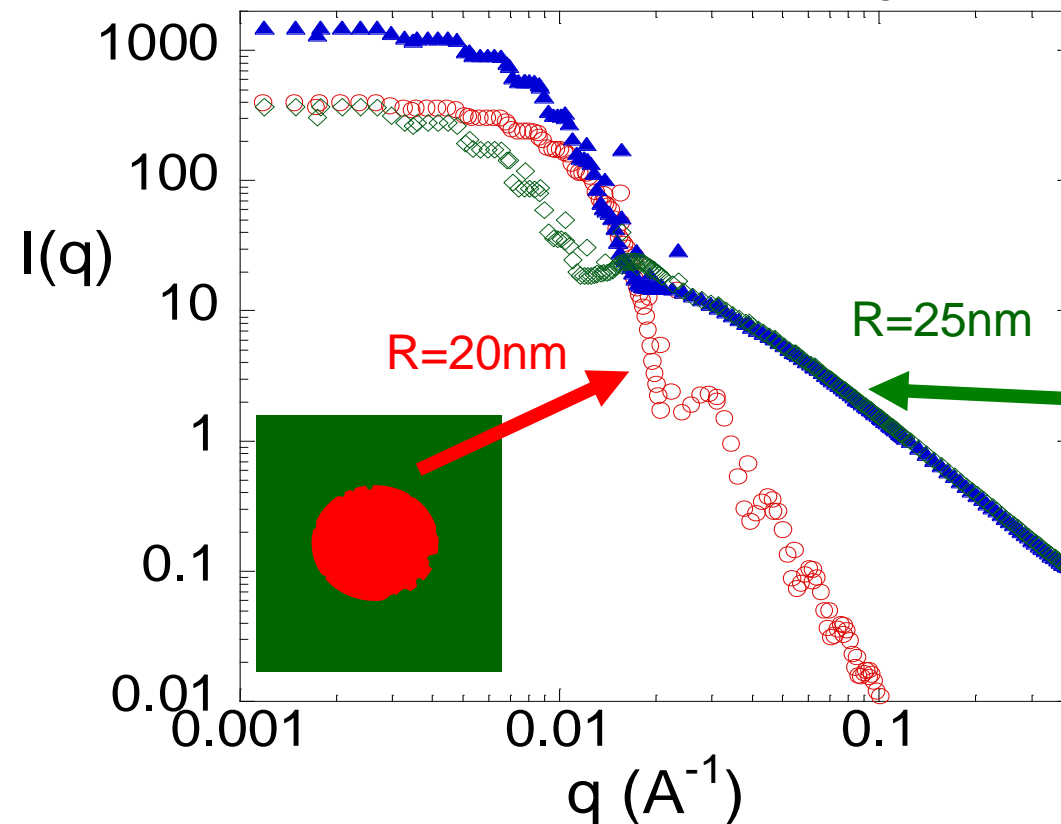

# X-rays and neutrons: some highlights

## Neutron Scattering : SANS

### POLARIZED NEUTRONS

$$I^+ = F_N^2 + (F_M^2 - 2PF_NF_M)\sin^2\alpha$$

$$I^- = F_N^2 + (F_M^2 + 2PF_NF_M)\sin^2\alpha$$

Maghemite  $\text{Fe}_2\text{O}_3$  nanosphere

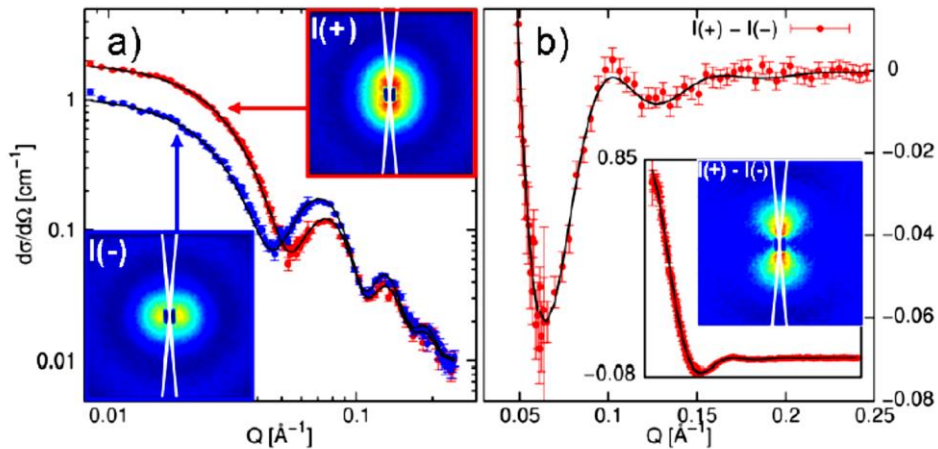
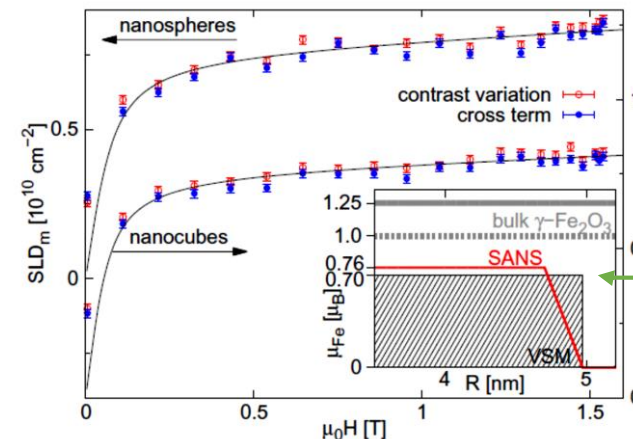
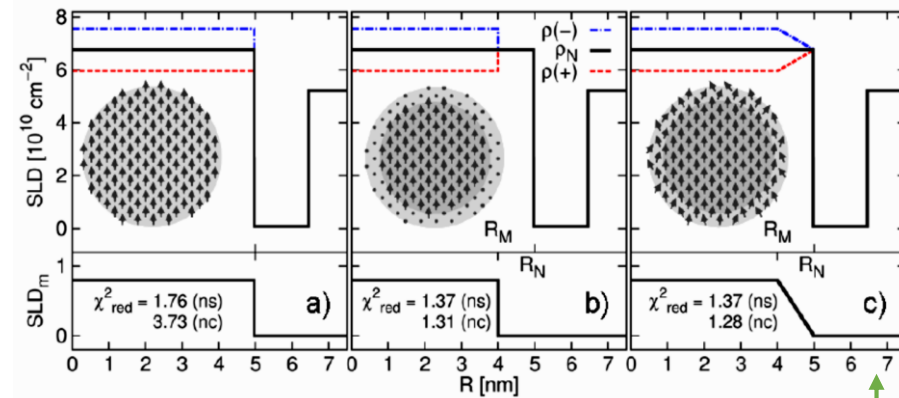

**Figure 4.** Polarized SANS by the nanospheres at room temperature and  $\mu_0 H = 1.5$  T. Solid lines: fits according to the model in figure 3(c). (a) Magnetic contrast variation of  $I(+)$  and  $I(-)$ . Inset:  $10^\circ$  sectors used for integration. (b) Magnetic–nuclear cross term derived from  $I(+)$  –  $I(-)$ . Inset: full intensity range of the data and the sectors used for integration.

S. Disch et al, *New Journal of Physics* 14 (2012) 013025

What is the correct magnetization distribution?

homogeneous      dead layer      canted layer



# X-rays and neutrons: some highlights

## Inelastic Neutron Scattering (INS)

INS provides information on rotations, vibrations, electronic transitions, crystal-field parameters, spin excitations

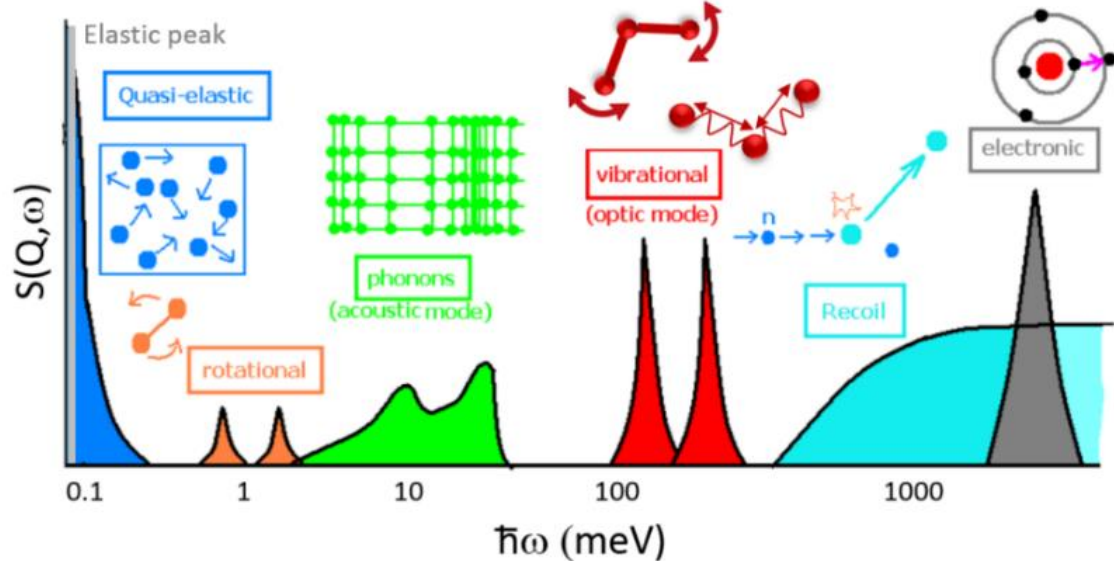

« single-molecule » magnet Mn12

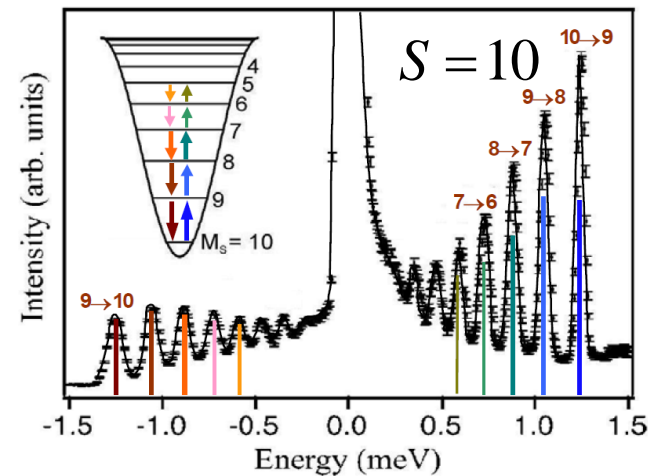
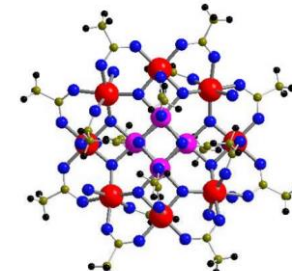

R. Bircher et al, Phys. Rev. B 70, 212413 (2004)

1D AFM CuGeO<sub>3</sub> : « two-magnon » continuum

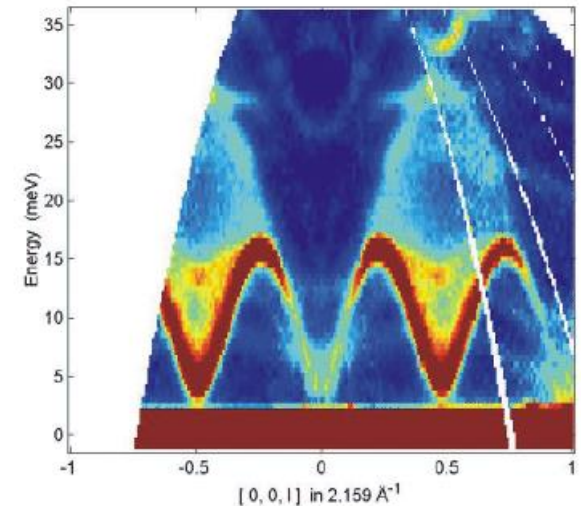

M. Arai et al, Phys Rev. Lett. 77, 3649 (1996)

# X-rays and neutrons: some highlights

## Imaging techniques (neutrons and x-rays)

Research into wood and soil

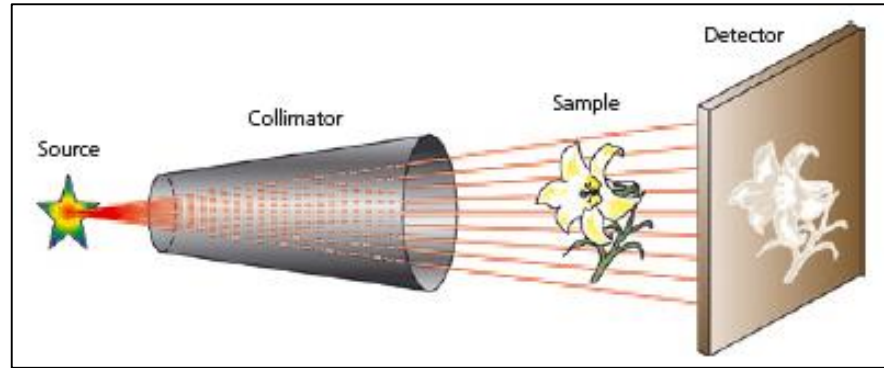

Archaeology and museum research:  
e.g. metal objects, paintings, wood artefacts



Hydrology and geology:

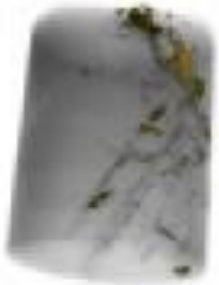

Paleontology: e.g. examination of fossils



Nuclear technology: e.g. examination of fuel elements and quality control



Materials research: e.g. investigations into alloys, welds, etc.



# X-rays and neutrons: some highlights

## Imaging techniques (neutrons)

### Neutron imaging benefits from

- the large penetration depth of the neutrons in many materials
- their strong interaction with light elements (H, Li)
- Their ability to differentiate isotopes (H/D)
- Non destructive probe

“Many metals including Pb are transparent to neutrons ”

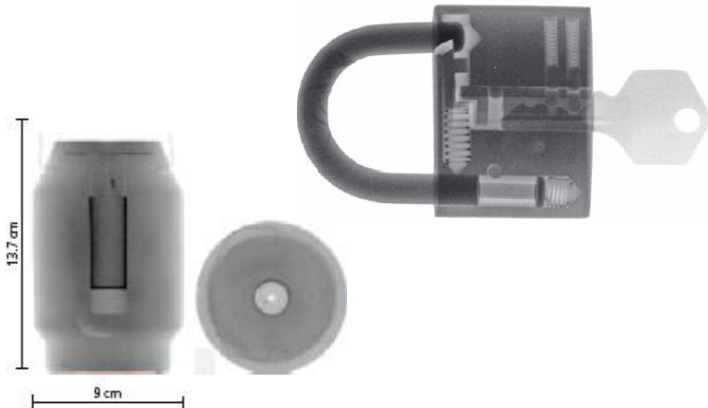

### « Following water »

Applications include detecting water contamination and tracing fluids inside a package, for MEMS, sensors or microfluidic devices for example

Fuel cell

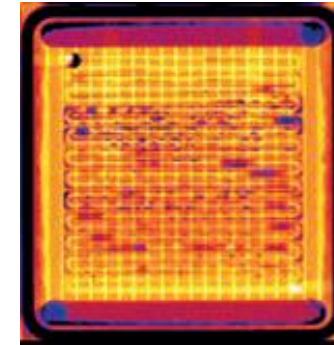

heat exchanger



### Archeology and culturel heritage



The Application of Neutron imaging to investigate the Design and Manufacture of a Bronze Oinochoe (Herringer et al, 2015)

visualize live root system

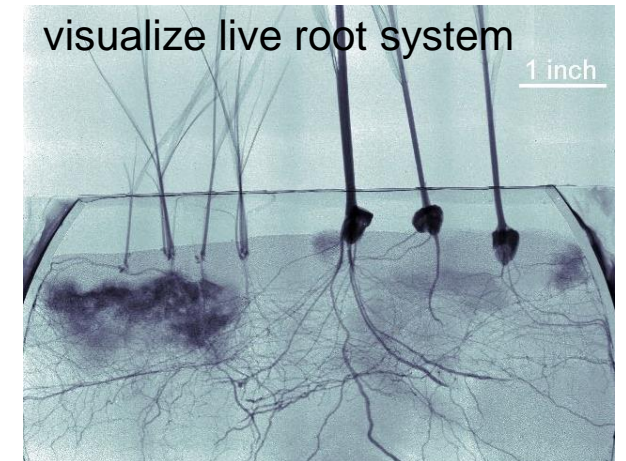

J. Warren (PI), H, Bilheux, M. Kang, S. Voisin, C. Cheng, J. Horita, E. Perfect, Plant Soil, 2013)

# X-rays and neutrons: some highlights

## Imaging techniques (neutrons)

### Neutron imaging benefits from

- the large penetration depth of the neutrons in many materials
- their strong interaction with light elements (H, Li)
- Their ability to differentiate isotopes (H/D)
- Non destructive probe

“Many metals including Pb are transparent to neutrons ”

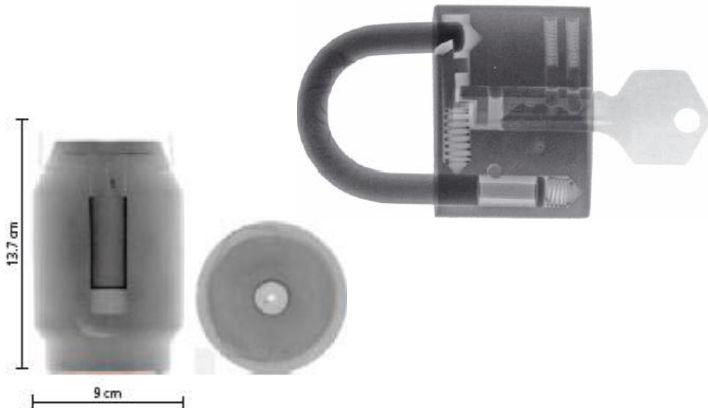

### « Following water »

Applications include detecting water contamination and tracing fluids inside a package, for MEMS, sensors or microfluidic devices for example

Fuel cell

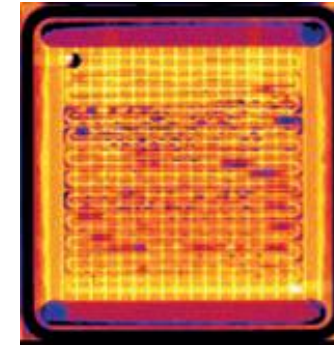

heat exchanger



### Archeology and culturel heritage

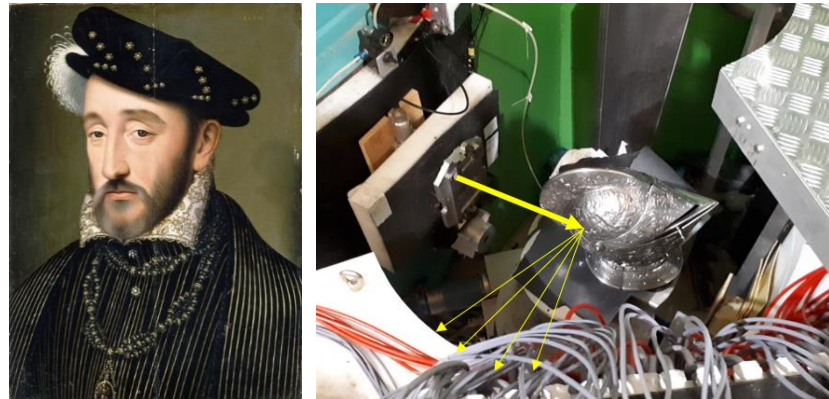

Henri II (King of France 1519-1559) and his “dueling” Helmet (Le Louvre Museum)

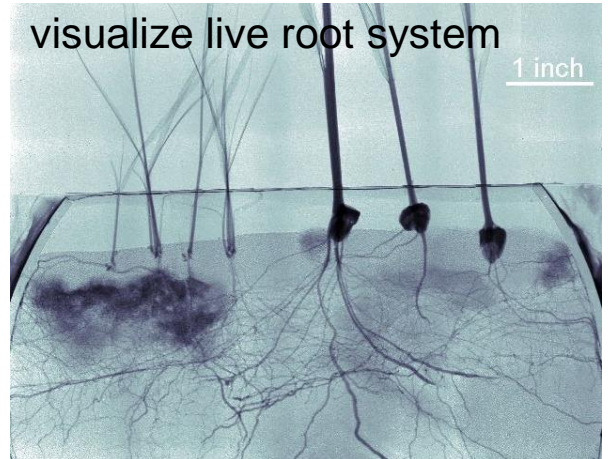

J. Warren (PI), H, Bilheux, M. Kang, S. Voisin, C. Cheng, J. Horita, E. Perfect, Plant Soil, 2013)

# X-rays and neutrons: some highlights

## Imaging techniques (x-rays)

**Synchrotron X-ray 2D and 3D imaging** beamlines offer ultra-high spatial and time resolutions to observe the inner details of complex structures in the **nanometre and micrometre ranges**.

### X-ray micro-tomography

Spatial resolutions down to 400 nm

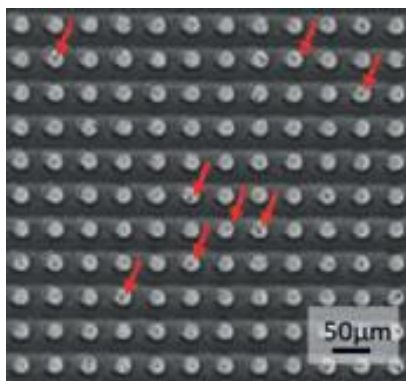

Array of Copper pillars

### X-ray nano-tomography

Spatial resolution down to 30 nm (with 10 nm pixel size)

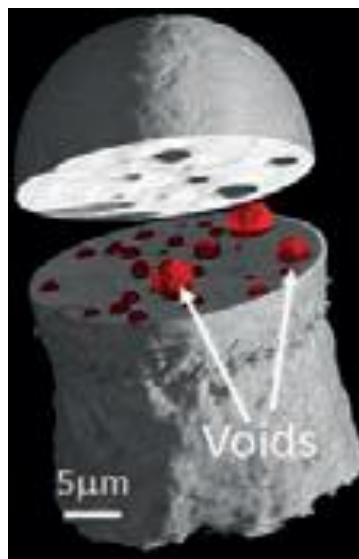

Inside a single Copper pillar

### Xrays imaging « operando »

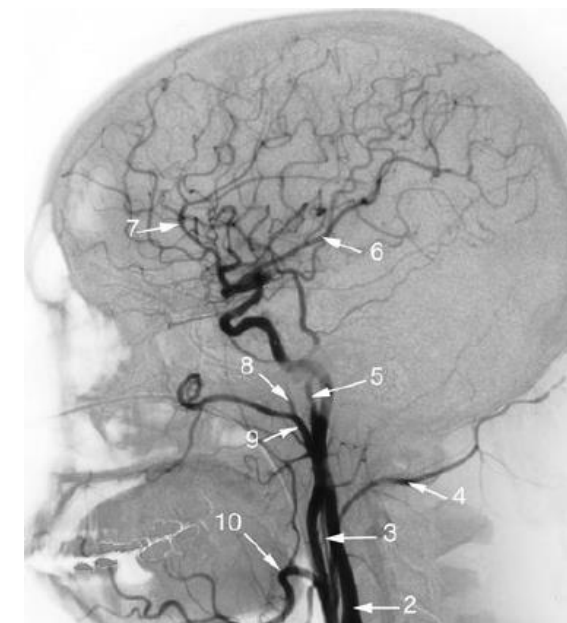

# X-rays and neutrons: some highlights

## Imaging techniques (x-rays)

**Synchrotron X-ray 2D and 3D imaging** beamlines offer ultra-high spatial and time resolutions to observe the inner details of complex structures in the **nanometre and micrometre ranges**.

### X-ray micro-tomography



### X-ray nano-tomography

Spatial resolution down to 30 nm  
(with 10 nm pixel size)



Inside a single  
Copper pillar

### Xrays imaging « operando »

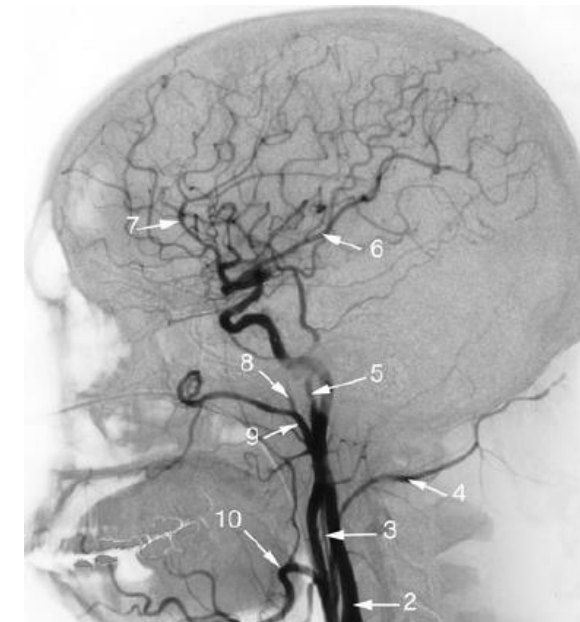

# X-rays and neutrons: versatile tools

## Soft Matter and Biological Systems

SANS, SAXS, reflectometry, diffraction  
(from atoms to bacteria)

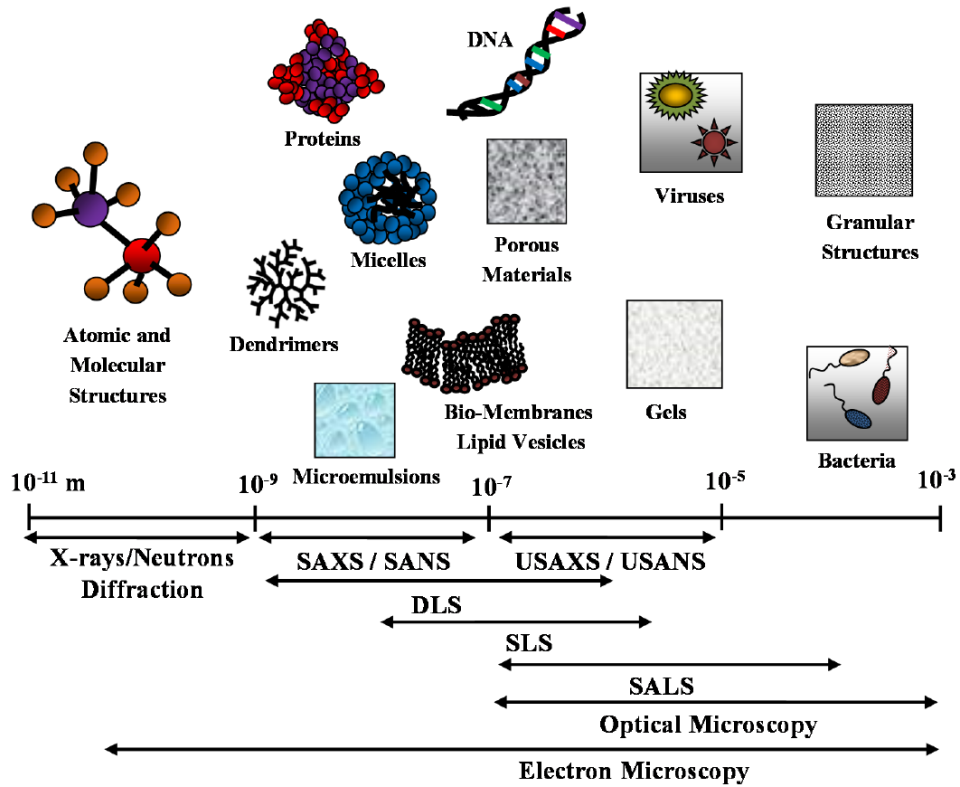

Encounter in everyday life



Self-Assembled Soft Matter Systems

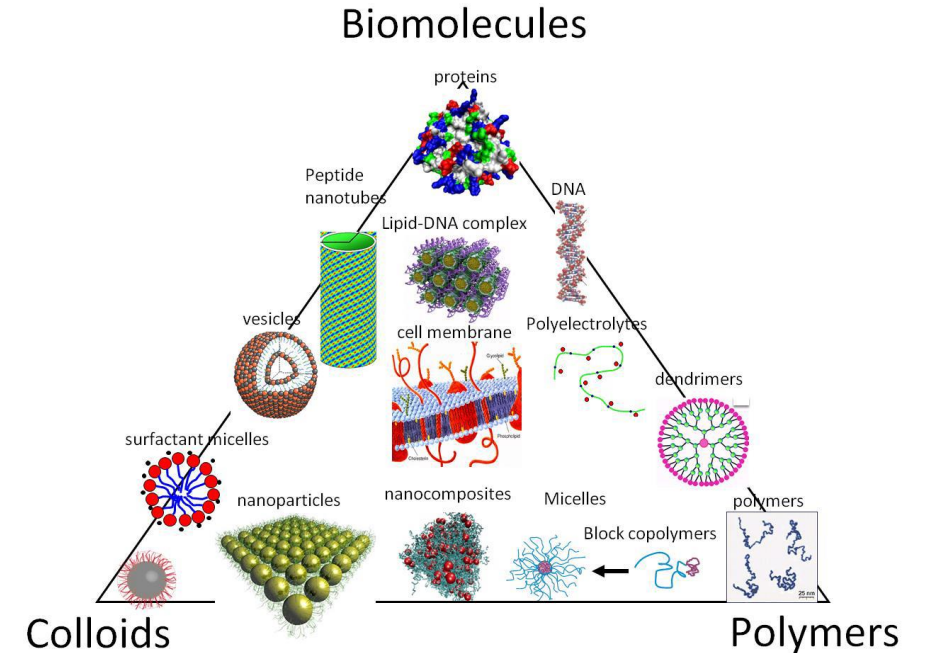

T. Narayanan et al., Crystallogr. Rev. (2017)

# X-rays and neutrons: versatile tools

## Functional and Energy Materials

More and more complex sample environments  
(closer to operating conditions and industries)

- **Environmental = « In situ »**  
Temperature, Pressure  
Magnetic field, Electric field
- **Functional = « Operando »**  
Electrochemistry, Chemical Reaction  
Mechanical Process, Light

“Real materials, real conditions, real time.”

- Energy storage
- Catalysts
- Reactions
- Transport and diffusion

Diesel fuel injectors spray dispersal

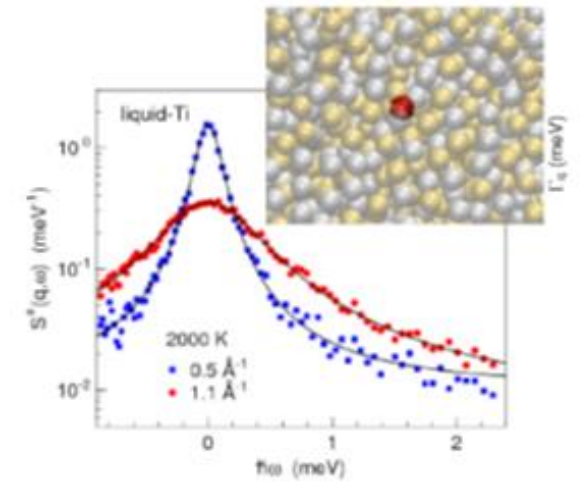
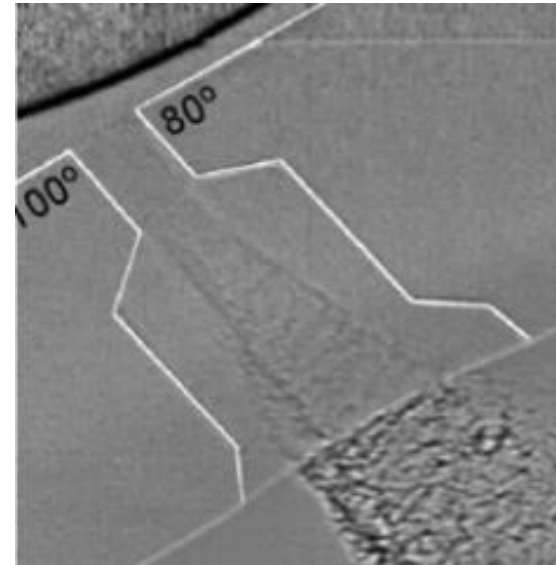

Atomic diffusion in liquid metals

Structure and properties

- Dynamic processes, kinetics, out-of-equilibrium
- Phase transitions
- reactions

# Neutron and X-ray synchrotron large-scale facilities as major tools for science and industry

## Conclusions and outlook

### Neutron and X-rays key techniques in materials sciences »

- **Neutrons** and **X-rays** provide a unique set of tools to explore the structural, chemical, and physical properties of matter
- Numerous techniques + **huge progress** have allowed researchers to investigate deeper and deeper, with **more flux, more resolution, more precision**
- Neutrons and X-rays are **complementary tools** with strengths and (few) weaknesses.

### « addressing society's grand challenges »

#### Energy

- New storage materials
- Transport and production

#### Industry & Materials

- Engine imaging and diagnostic
- Oils, metallurgy, pollutants

#### Health & Life

- Structure of biomolecules (proteins, enzymes)
- Drug delivery, cancer treatment, food

#### Arts & Cultural Heritage

- Archaeological objects, artefacts, arts

# Neutron and X-ray synchrotron large-scale facilities as major tools for science and industry

## Conclusions and outlook

Neutron and X-rays  
key techniques in materials sciences »

« addressing societal challenges »

- **Neutrons and X-rays** provide a unique set of tools to explore the structural, chemical, and physical properties of matter
- Numerous advances have allowed researchers to go deeper and deeper, with **more flux, more resolution, more precision**
- Neutrons and X-rays are **complementary tools** with strengths and (few) weaknesses.

**Neutrons and X-rays Facilities are here for you : apply for beam time and make the best of them!**

transport and production

### Industry & Materials

- Engine imaging and diagnostic
- Oils, metallurgy, pollutants

### Health & Life

- Structure of biomolecules (proteins, enzymes)
- Drug delivery, cancer treatment, food

### Arts & Cultural Heritage

- Archaeological objects, artefacts, arts