

# Toujours plus haut, Toujours plus loin ou Thingsat un véhicule de recherche pour l'expérimentation in-vivo ouverte de l'Internet des Objets par Satellite



LIG (Didier Donsez, Olivier Alphand, Florent Dobler, Leo Cordier),  
CROMA (Tan Phu Vuong, Nhu Huan NGuyen, Vincent Grennerat)  
CSUG (Thierry Sequies, Mathieu Barthelemy, Jean-Louis Monin, Estelle Moraux)



# L'internet des Objets

## Des objets connectés omniprésents

### Libelium Smart World

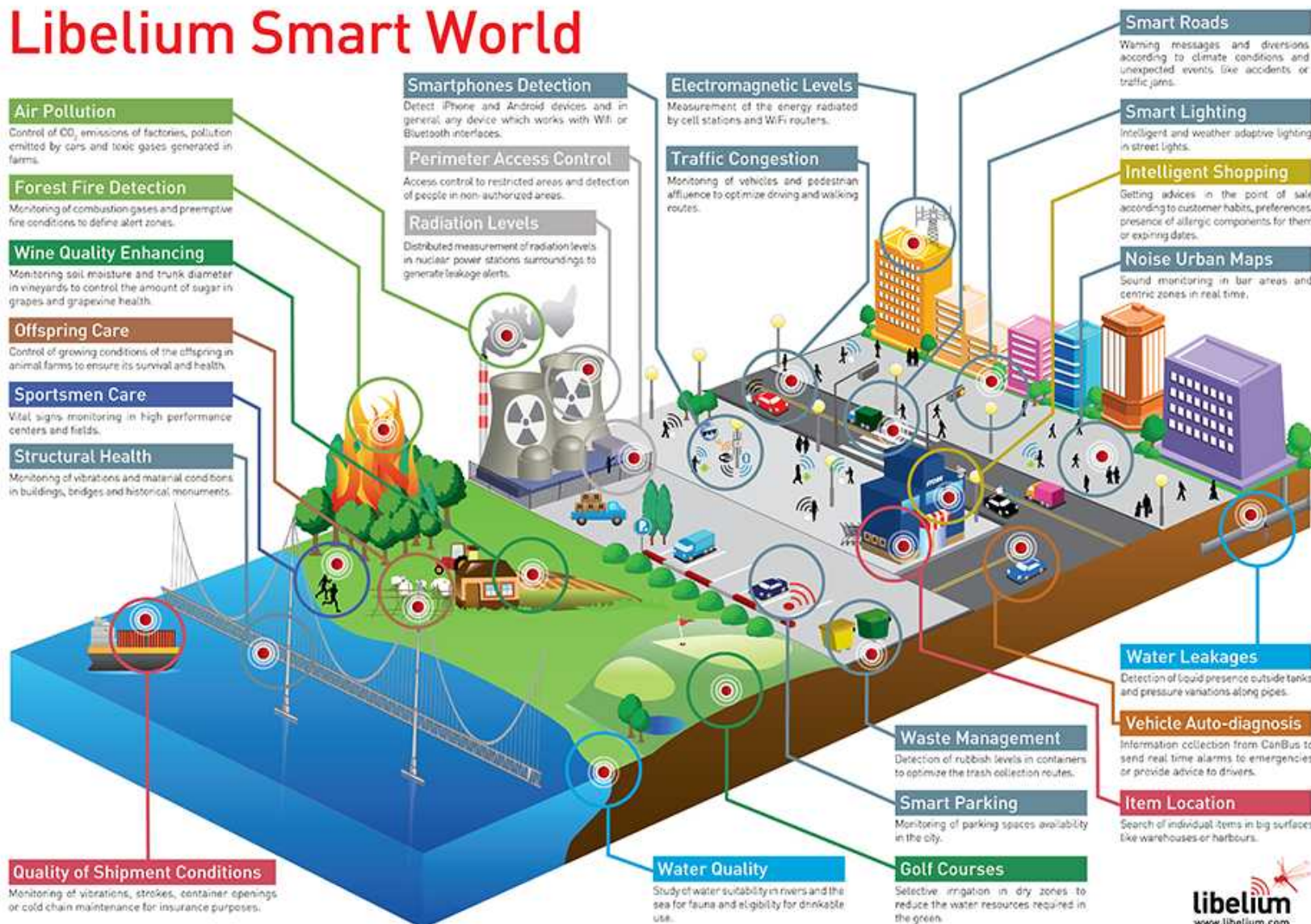

# Architecture d'un réseau pour l'IoT

IoT Applications



Cloud infrastructure  
(public, private)

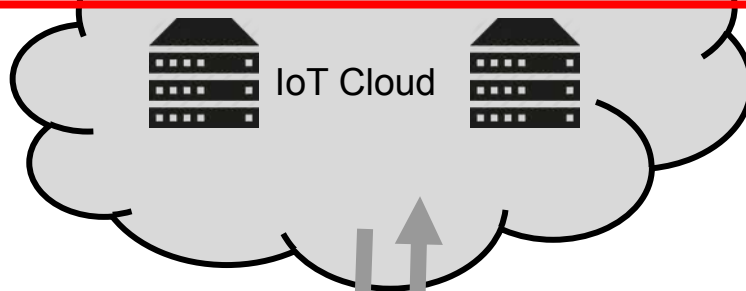

Fog/Edge Computing

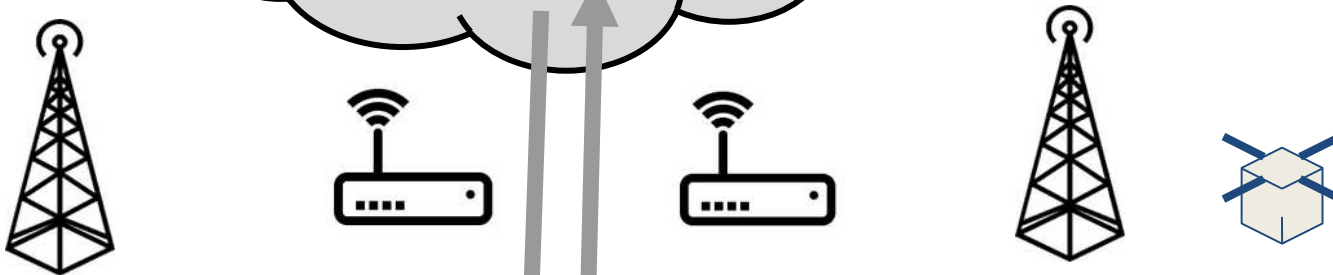

Communications

- wired/wireless
- IP / No IP
- licensed/free bands



Connected Things  
(sensors & actuators)

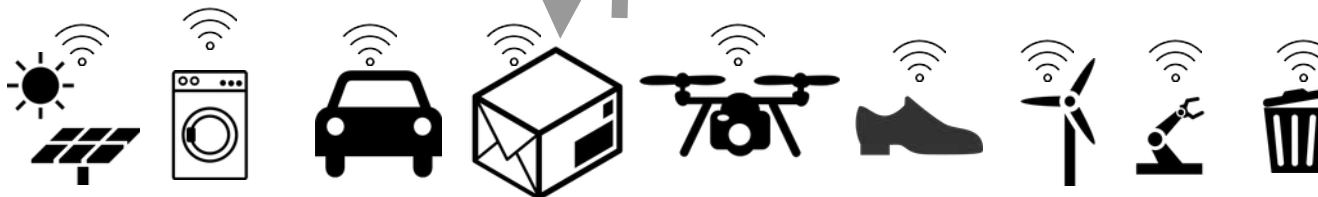

# Internet des Objets et Temps Fréquence

- Applications
  - Suivi d'assets (logistique, bétail, vol .
  - Geo fencing
  - Datation d'événement
  - Opérations sur calendrier



invoxia, tractive ...



ttgo



adeunis



scooter



invoxia



abeeway



SoluM KeyCo



LR1110 GNSS + Wifi  
LoRa tracker



# Internet des Objets et Temps Fréquence (suite)

Cœur de réseau (au sein du datacentre)

Stations de base (Gateway, eNB)

- Datation d'événement RX ( $\sim\mu\text{s}$ ,  $\sim\text{ns}$ )
  - **TDOA**
- Programmation d'une émission TX ( $\sim\mu\text{s}$ ,  $\sim\text{ns}$  sur PPS GNSS)
  - Sync NB-IoT
  - LoRaWAN beacon classe B
  - diffusion de temps

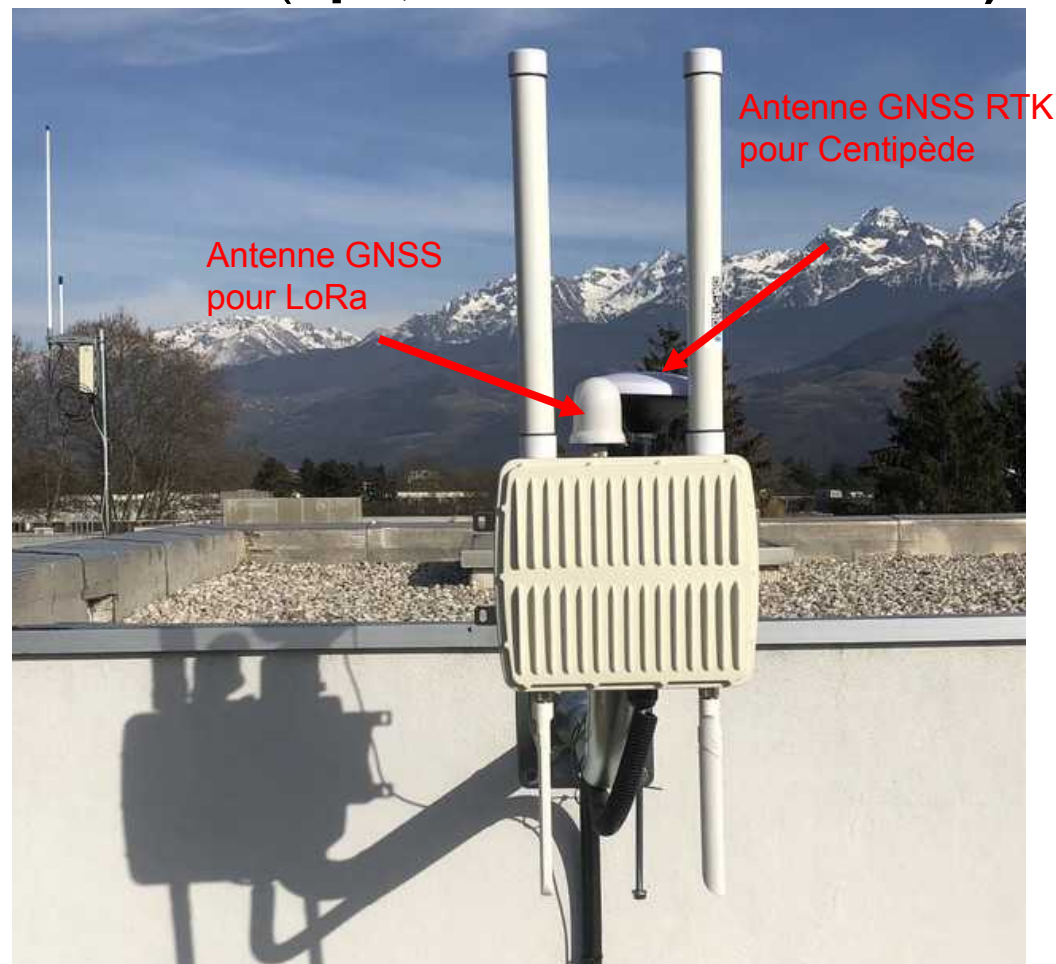

# Internet des Objets et Temps Fréquence (suite)

- LoRa (868, 2400) et GNSS RTK

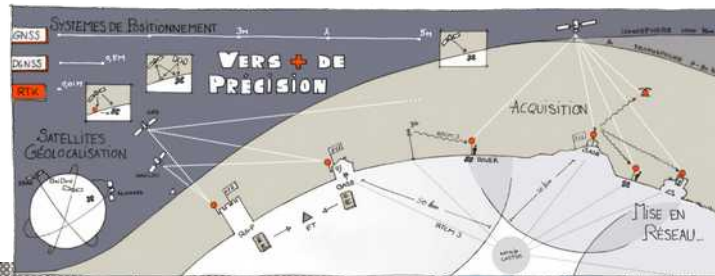

N.Palix, D. Donsez @ Grenoble + Col du Lautaret

<https://hal.science/hal-04786259>

[https://github.com/i2hm/micro\\_climate\\_station/tree/main/kicad/lc29h\\_mikrobus](https://github.com/i2hm/micro_climate_station/tree/main/kicad/lc29h_mikrobus)



JM Friedt @ Corbel, Svalbard



# GPSJam GPS/GNSS Interference Map

<https://gpsjam.org/?lat=45.59926&lon=32.14739&z=4.1>

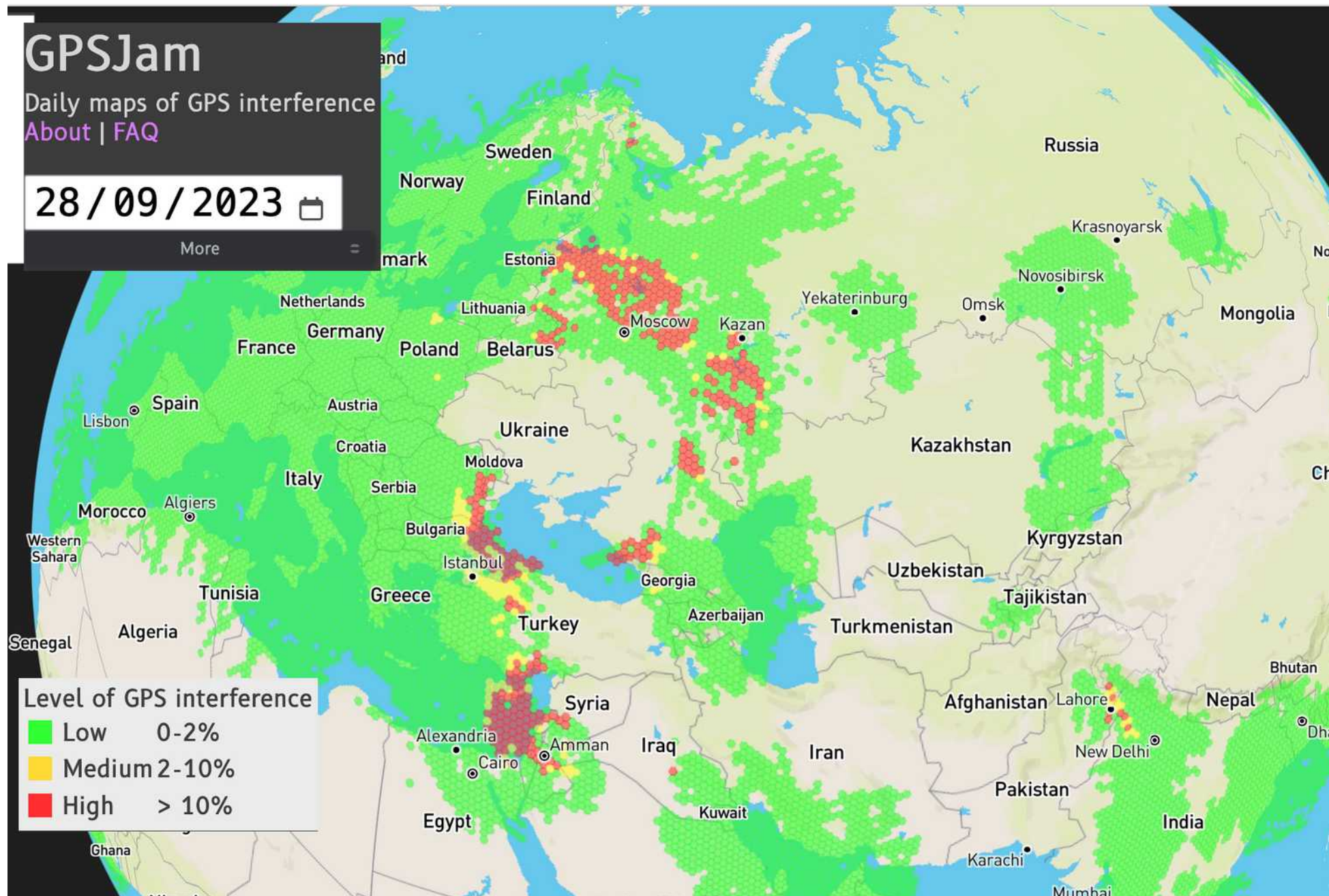



# Guerre électronique / Electronic Warfare Bouillage et Leurrage GNSS



A Russian Krasukha-4 jamming station was captured in Ukraine in March  
The Russian Krasukha-4 is designed to jam low-orbit signals, drones and missiles



A Russian R-330ZH Zhitel station used to jam GPS signals



# Guerre électronique / Electronic Warfare

## Bouillage et Leurrage GNSS

<https://www.gps.gov/cgsic/meetings/2024/humphreys.pdf>

~100 kW nuclear power unit



Тип системы электропитания	Ядерная энергоустановка нового поколения типа ЯЭУ 25М
Разработчик	ОАО "Красная Звезда"
Срок активного существования, лет	не менее 7

АРСЕНАЛ  
Основан в 1711 г.

ИНСТИТУТ РАДИОТЕХНИКИ И СВЯЗИ  
АРСЕНАЛ  
Основан в 1948 г.

Russia may be pursuing a radical escalation of EW:  
A nuclear-powered interference source in space. [Project Ekipazh](#).

# Exemple de leurrage GPS dans un réseau LoRaWAN (station de base et suiveur GPS)

Grenoble, 220m, 14/02/2020 → Svalbard, 8849m, 24/12/2019

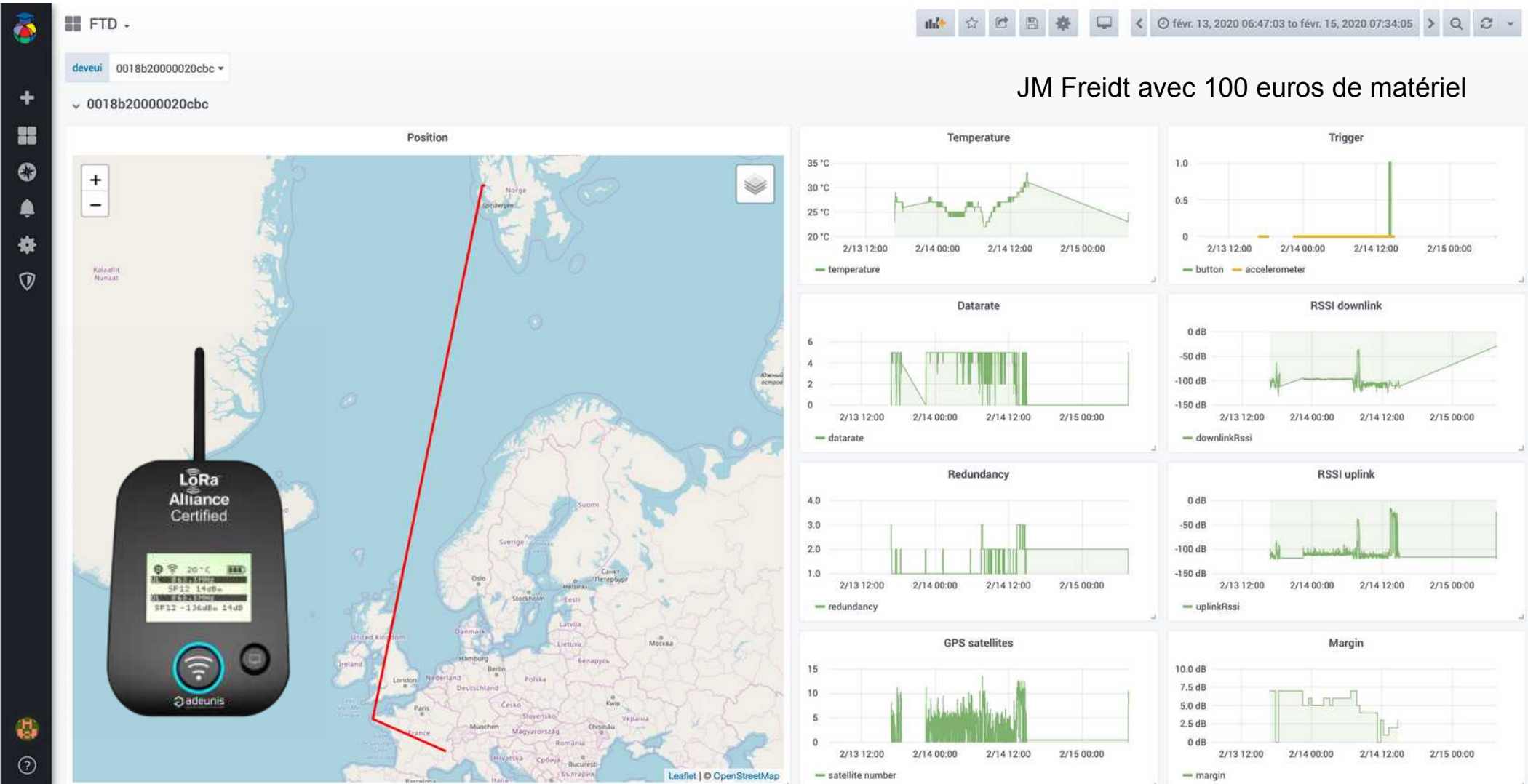



# Technologies de communication sans fil pour l'IoT

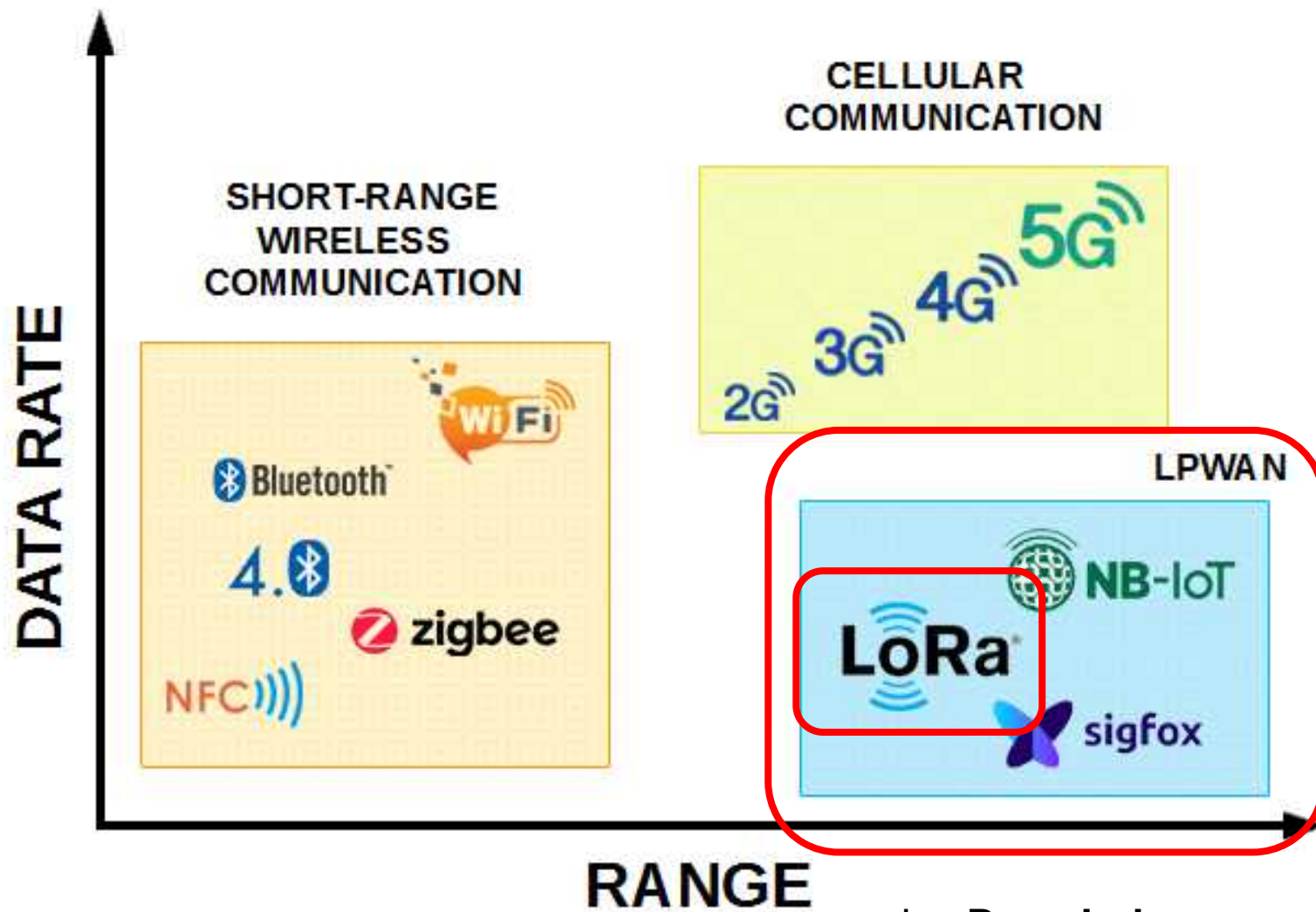

also Deep Indoor

# LoRa® vs LoRAWAN



- LoRa® : Technologie Radio LPWAN
  - Définit la couche physique d'une pile réseau : LoRa PHY
- LoRaWAN : un protocole réseau "sur" LoRa 
  - Définit la couche MAC (Medium Access Control)

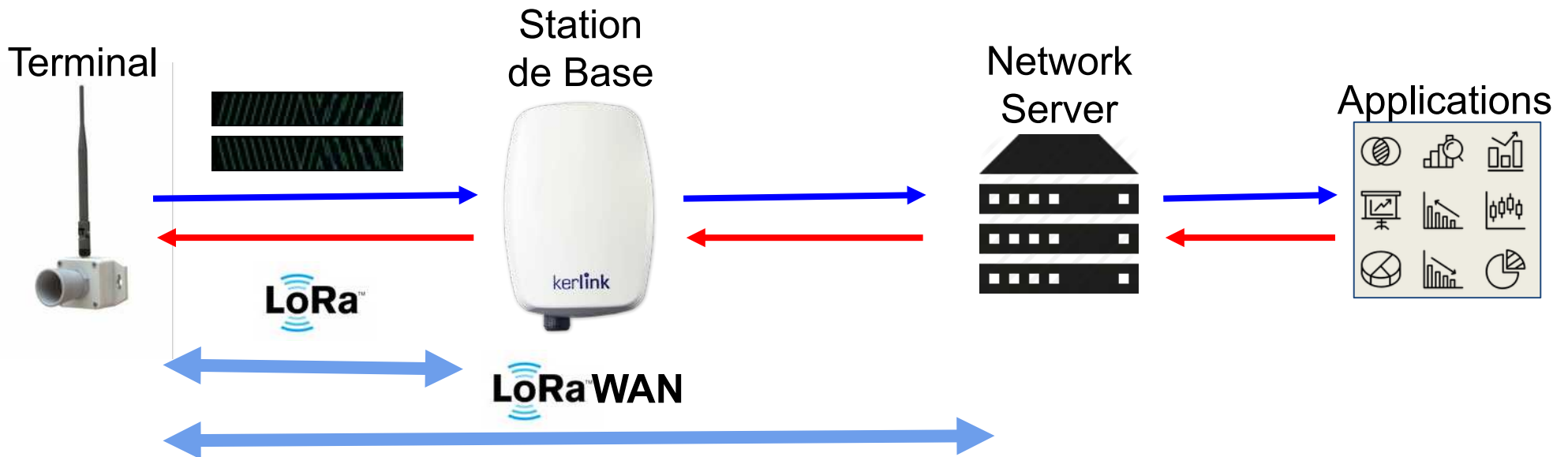



# Modulation

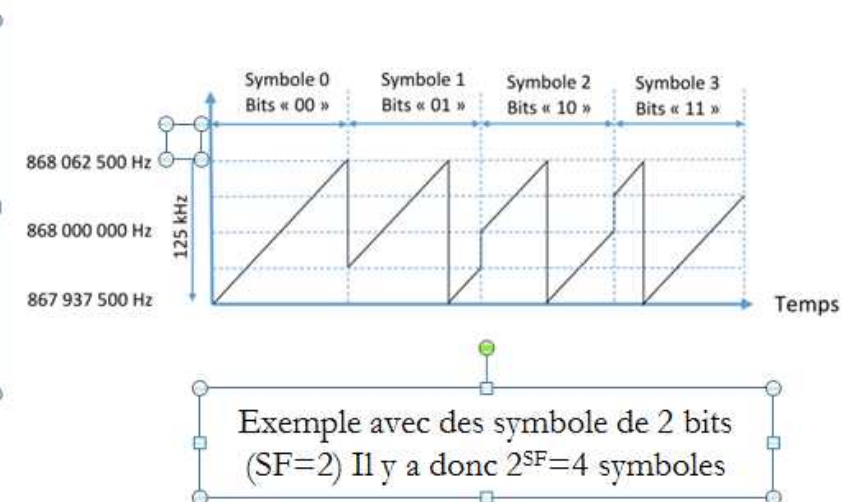
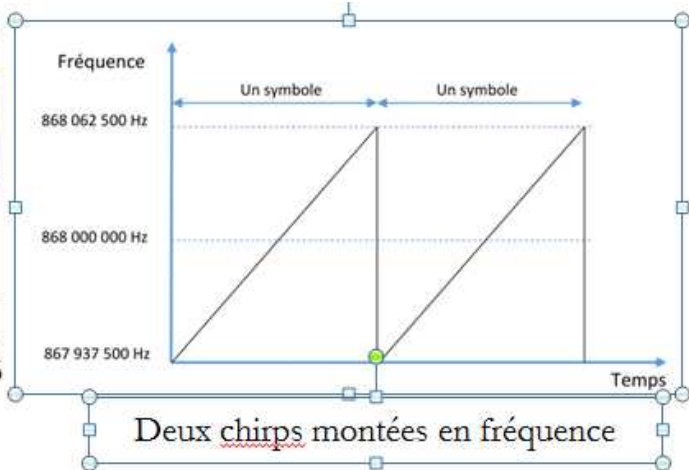
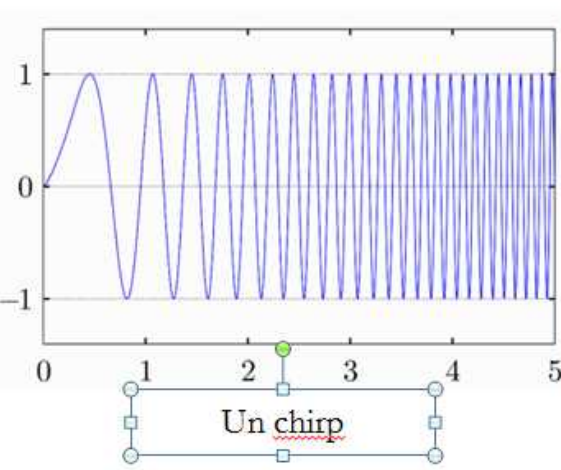

DR	12	11	10	9	8	7	7	...
Modulation	LoRa modulation	LoRa modulation	LoRa modulation	LoRa modulation	LoRa modulation	LoRa modulation	LoRa modulation	FSK
Bandwidth (BW)(bp)	125	125	125	125	125	125	250	50K
Bitrate (BR)(bps)							10,937	
Receive sensitivity (dBm)							-120	-108
Time-on-air and consumption	292	537	976	1,757	3,125	5,468	-126	-123
	-136	-133	-132	-129	-126			

Data rate (DR)  
 Range  
 Spreading factor (SF) Nombre de bit par symbole  
 Bandwidth (BW)(bp) Variation de fréquence lors d'un Chirp  
 Bitrate (BR)(bps)  $BR = SF \cdot BW / 2^{SF}$

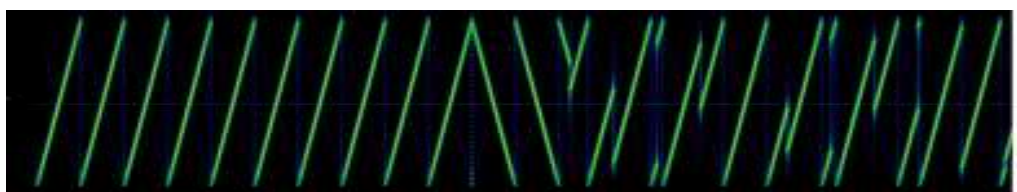
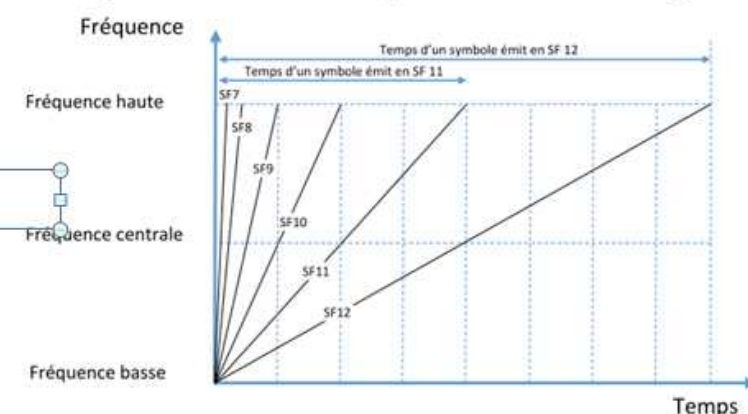

# Modulation LR-FHSS

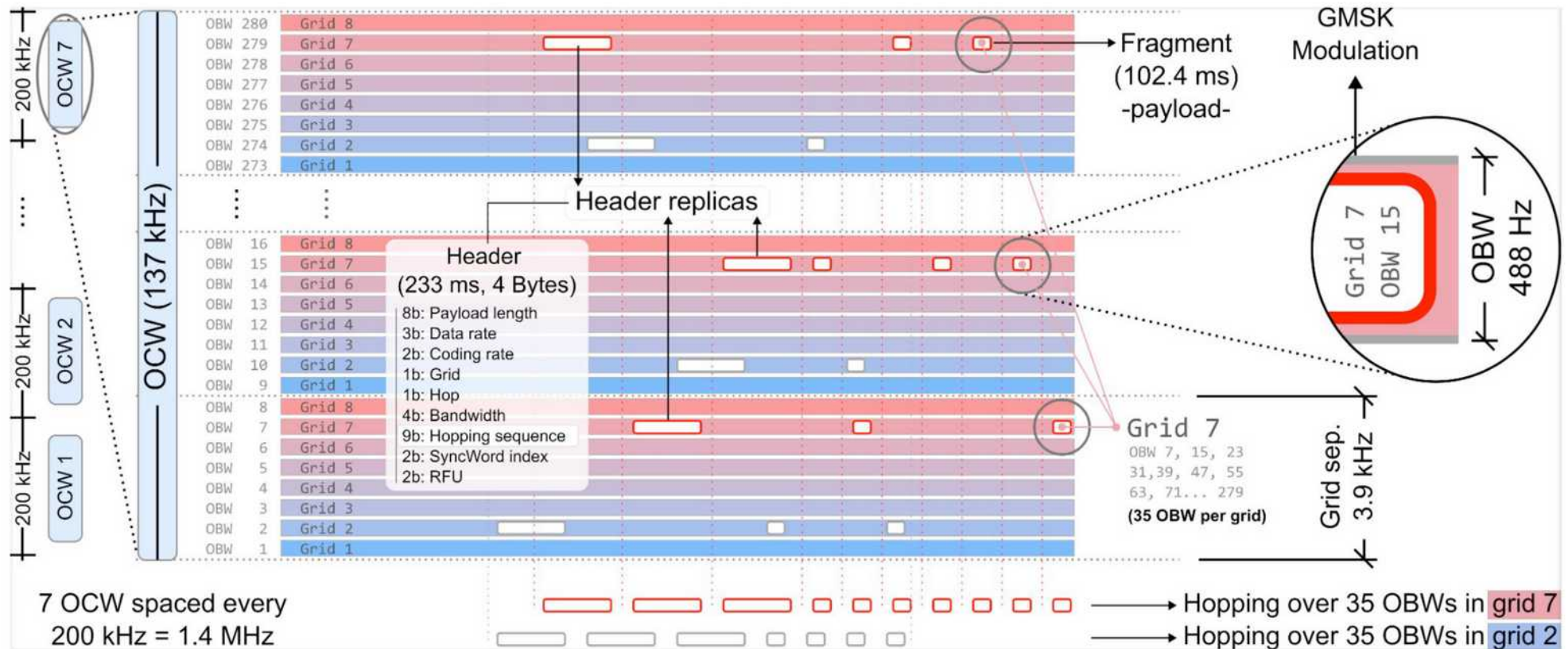
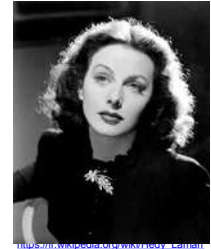



# Modulation LoRa

## Robustesse au Bruit

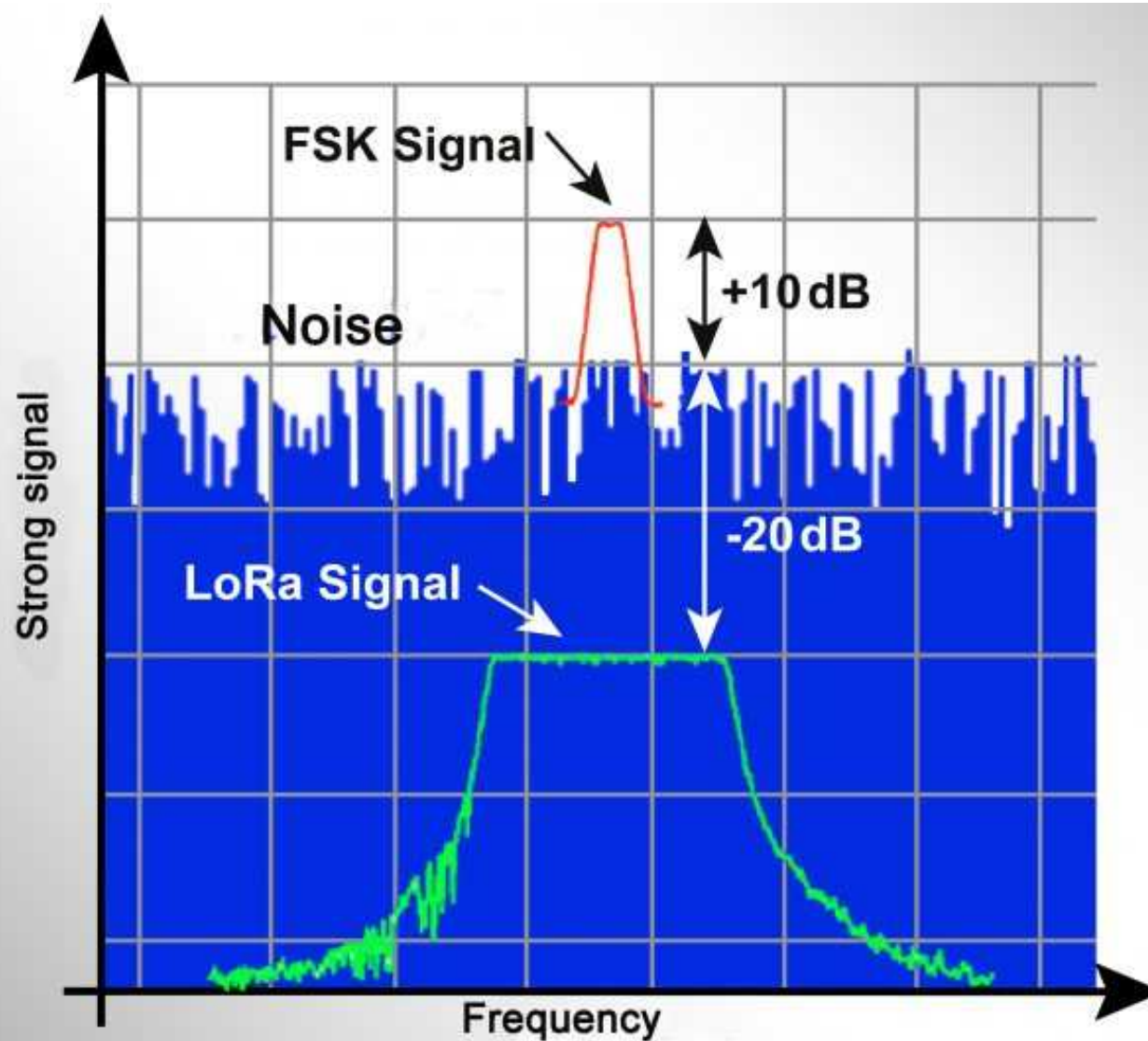

# Low-Power and Long Range WAN

Example: Elsys ELT2 (LoRa endpoint with temperature sensor)

- Battery lifetime from **6** to **18** years (1 temp. msg/hour)



Sample time: 3600 Seconds

Sensor: ELT2 HP

Battery capacity: 2700 Capacity(mAh)

Battery performance: 80 Performance(%)

Spreading factor:  SF7  SF8  SF9  SF10  SF11  SF12

**Result:**  
 The battery will last for **6.2** years\*. The sensor will draw **40uA** and **351mAh** in one year.

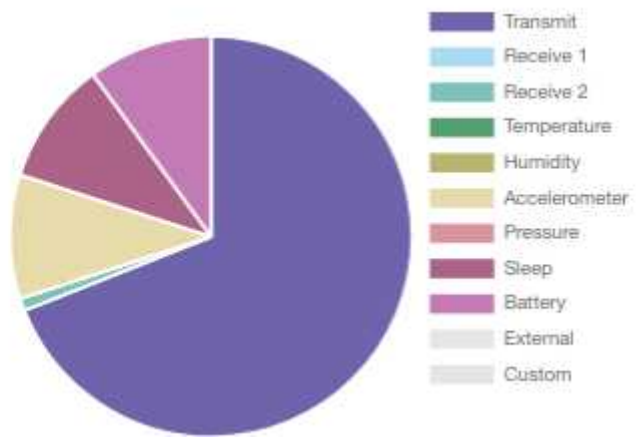

Sample time: 3600 Seconds

Sensor: ELT2 HP

Battery capacity: 2700 Capacity(mAh)

Battery performance: 80 Performance(%)

Spreading factor:  SF7  SF8  SF9  SF10  SF11  SF12

**Result:**  
 The battery will last for **18** years\*. The sensor will draw **14uA** and **120mAh** in one year.

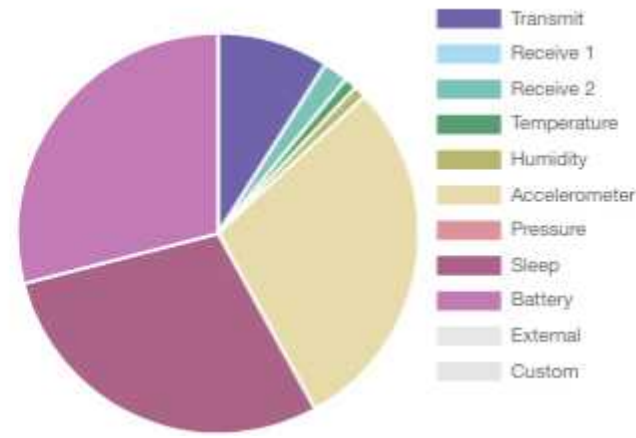



# Low-Power and Long Range WAN



<https://www.elsys.se/en/battery-life-calculator/#>

<https://avbentem.github.io/airtime-calculator/ttn/eu868/13,12>

[https://demo.iot.imag.fr/d/ems/ems?orgId=1&var-deviceName=ELSYS\\_EMS\\_B1C0\\_PER\\_RET\\_SSE&from=now-7d&to=now](https://demo.iot.imag.fr/d/ems/ems?orgId=1&var-deviceName=ELSYS_EMS_B1C0_PER_RET_SSE&from=now-7d&to=now)

# Low-Power and Long Range WAN however **Low Throughput**

## Duty cycle and airtime

- AS923
- AU915
- AU915 DL
- CN470
- EU868**
- IN865
- KR920
- US915
- US915 DL

### EU863-870 uplink and downlink

overhead size<sup>i</sup>      payload size<sup>i</sup>

- 13      - 12      +

	DR6 <sup>i</sup>	DR5	DR4	DR3	DR2	DR1 <sup>i</sup>	DR0 <sup>i</sup>
<i>data rate</i>	SF7 <sup>BW 250</sup>	SF7 <sup>BW 125</sup>	SF8 <sup>BW 125</sup>	SF9 <sup>BW 125</sup>	SF10 <sup>BW 125</sup>	SF11 <sup>BW 125</sup>	SF12 <sup>BW 125</sup>
<i>airtime</i>	30.8 ms	61.7 ms	113.2 ms	205.8 ms	411.6 ms	823.3 ms	1,482.8 ms
<i>1% max duty cycle</i>	3.1 sec 1,167 msg/hour	6.2 sec 583 msg/hour	11.3 sec 318 msg/hour	20.6 sec 174 msg/hour	41.2 sec 87 msg/hour	82.3 sec 43 msg/hour	148.3 sec 24 msg/hour

1% for g  
1% for g1  
10% for g4



# Low-Power and Long Range WAN

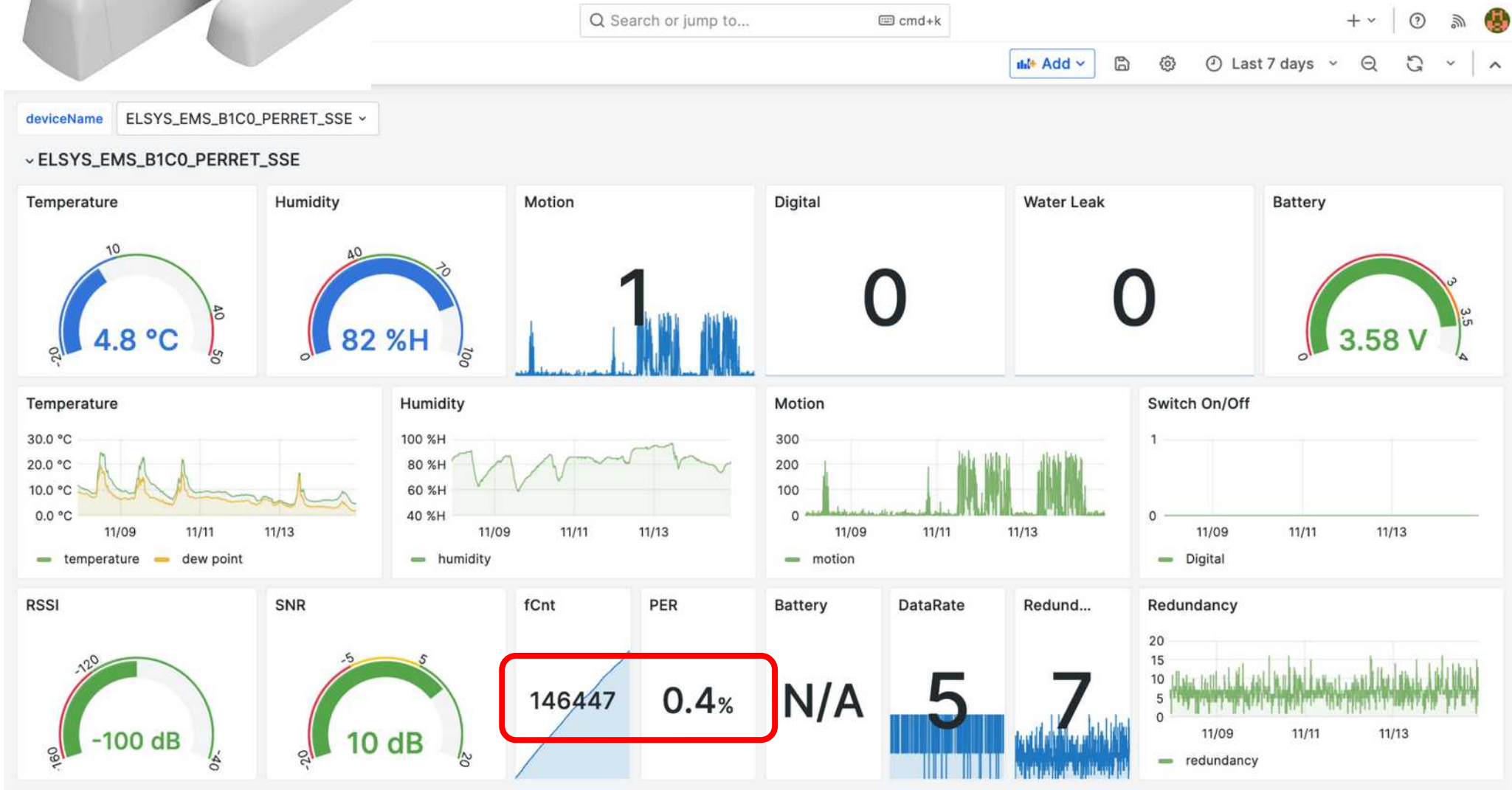

[https://demo.iot.imag.fr/d/ems/ems?orgId=1&var-deviceName=ELSYS\\_EMS\\_B1C0\\_PERRET\\_SSE&from=now-7d&to=now](https://demo.iot.imag.fr/d/ems/ems?orgId=1&var-deviceName=ELSYS_EMS_B1C0_PERRET_SSE&from=now-7d&to=now)

# Low-Power and Long Range WAN

Example: Elsys ELT2 (LoRa endpoint with temperature sensor)

- Mont-Blanc → Strasbourg 300 kms (Eclipse IoT Days 2018)





# Low-Power and Long Range WAN

PER 41% @ SF7BW125 Tx 2dBm (1.58 mW) airtime=62ms  
 109 Kms → FSPL=131.80 dB @ 868 MHz

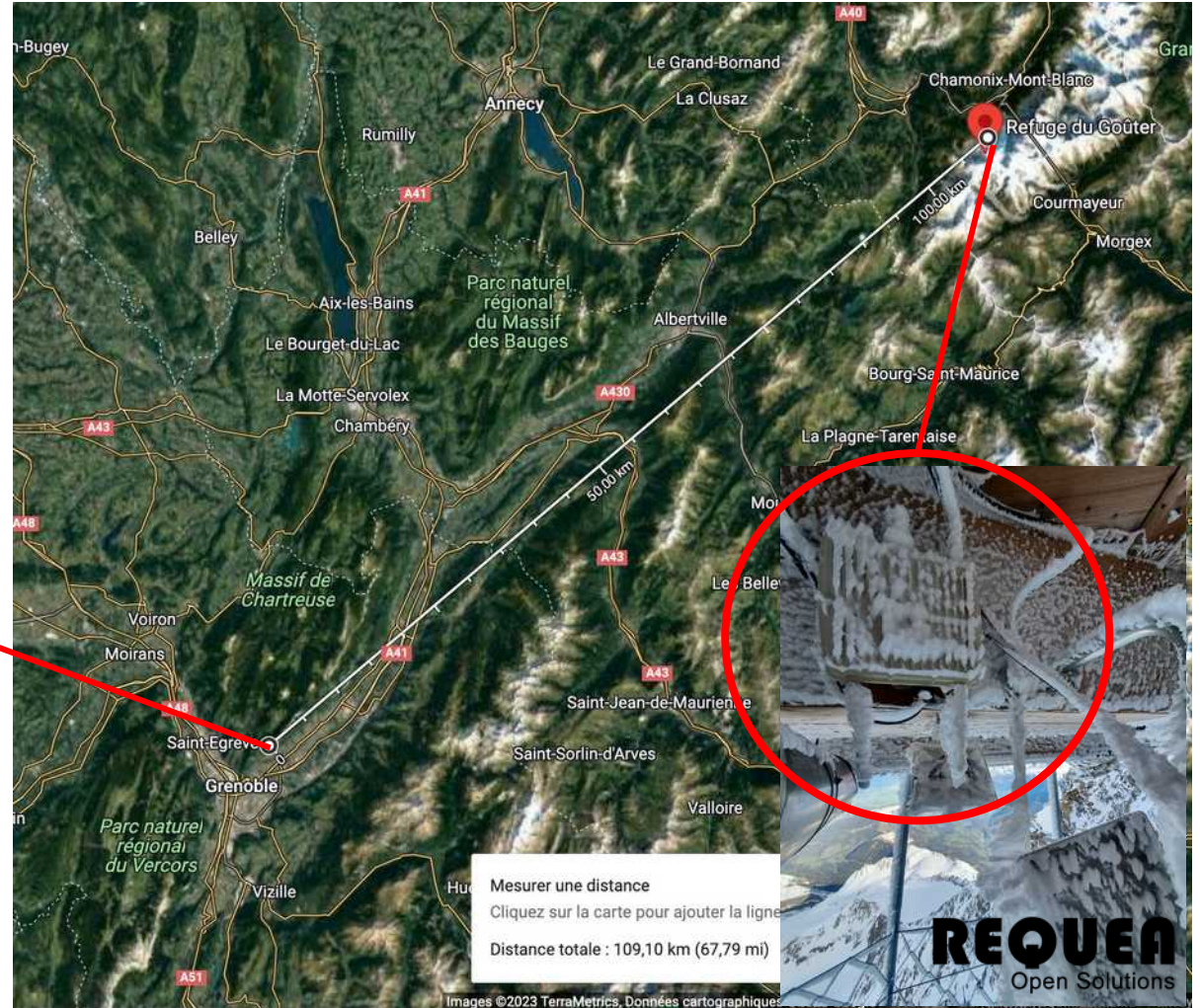



# Mais beaucoup de zones “blanches” sur la planète

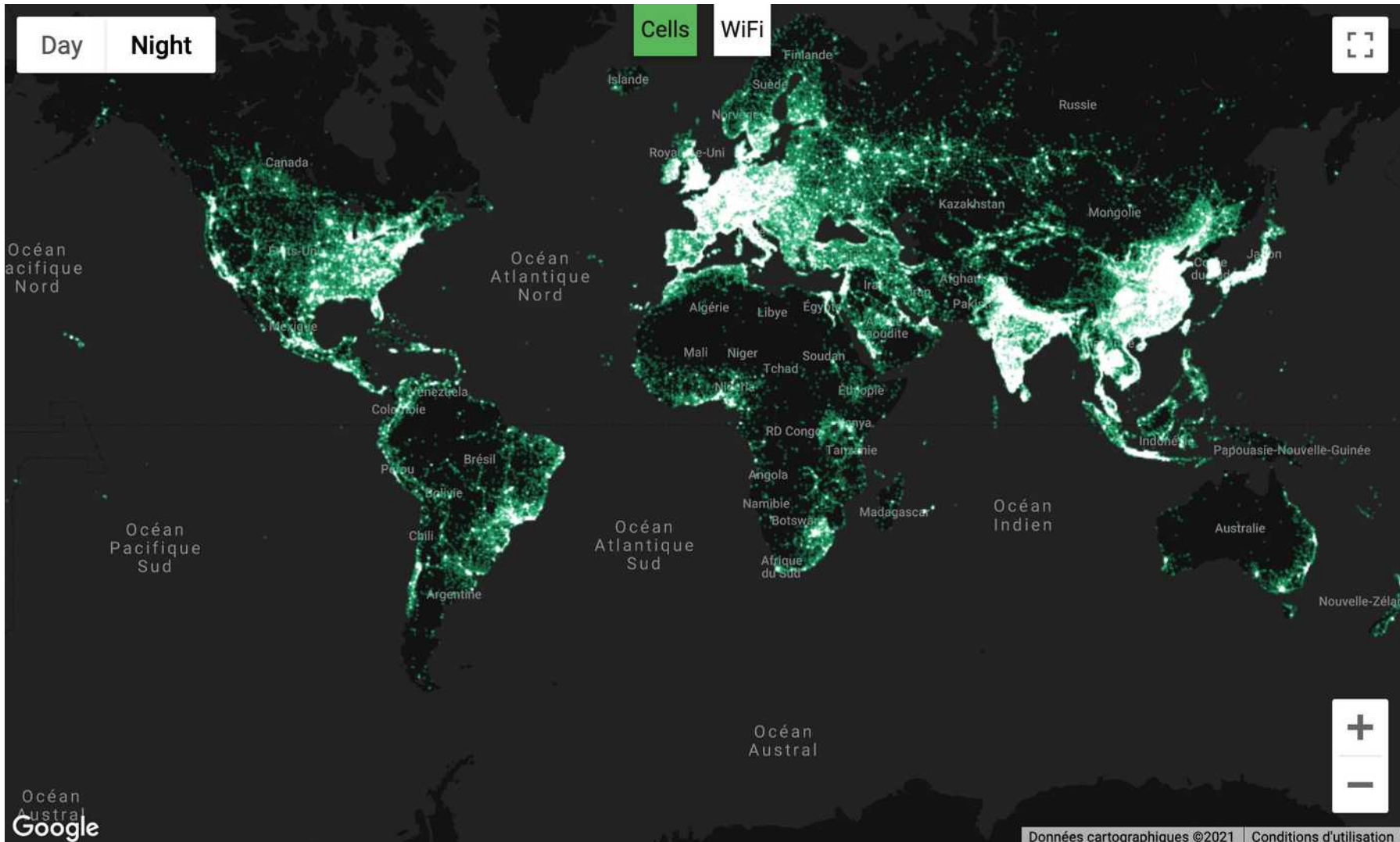

Couverture cellulaire et wifi <http://unwiredlabs.com/coverage>

# What is Direct-to-Satellite IoT ?

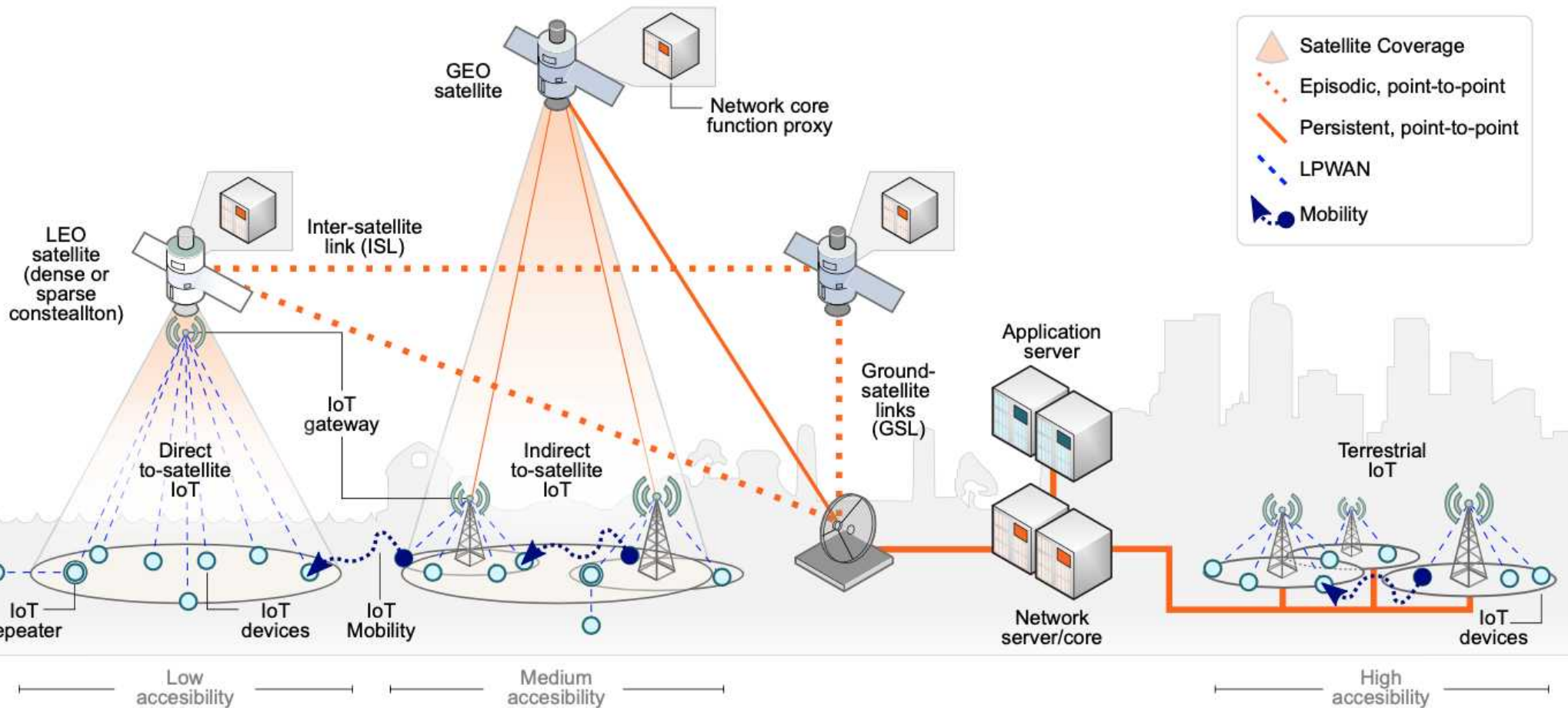
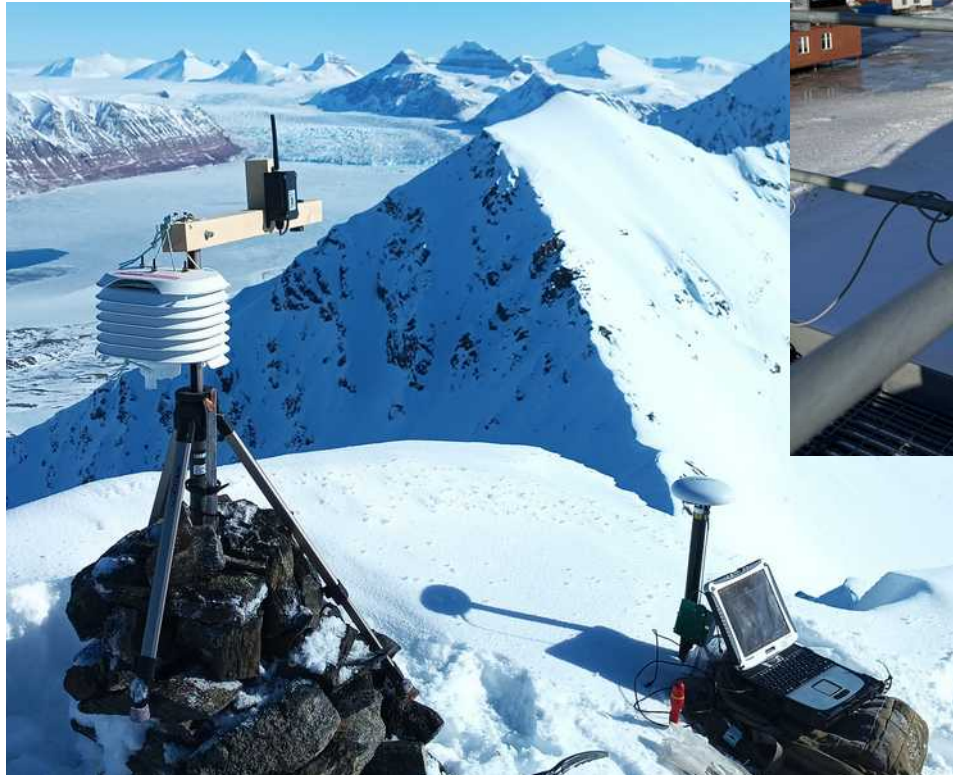

Figure from [Fraire et Al, « Space-Terrestrial Integrated Internet of Things: Challenges and Opportunities ». IEEE Communications Magazine 60, n° 12 (décembre 2022)]



# Glacier monitoring



# Transport maritime



(He + N pressure and level, GPS, 4G, LPGAN)

# I2HM (Internet of things and artificial Intelligent for Health monitoring) <https://i2hm.github.io/>

## Application : Microclimate sensors for Malaria surveillance

- Malaria (WHO, 2021)
  - **247 million cases** worldwide
  - **619,000 deaths** : 25% attributed to **environmental factors**
- Surveillance (IoT)
  - low cost and low tech LoRaWAN weather stations for collecting environmental data
- Prediction/prevention (IA ML)
  - Machine (Deep) Learning for predicting and alerting in case of Malaria epidemic hotspots
- **Sites** (covered by terrestrial LoRaWAN gateways or sat)
  - Yaoundé (Cameroun), Niamey (Niger)
  - **Remote areas of African countries are badly covered by terrestrial networks**





# Volcanologie

Des volcans et des hommes

près de 50% de la population mondiale à moins de 31 km d'un volcan  
et environ 80% dans un rayon de moins de 60 km

Prévision des événements catastrophiques

Surveillance dans la caldera du volcan

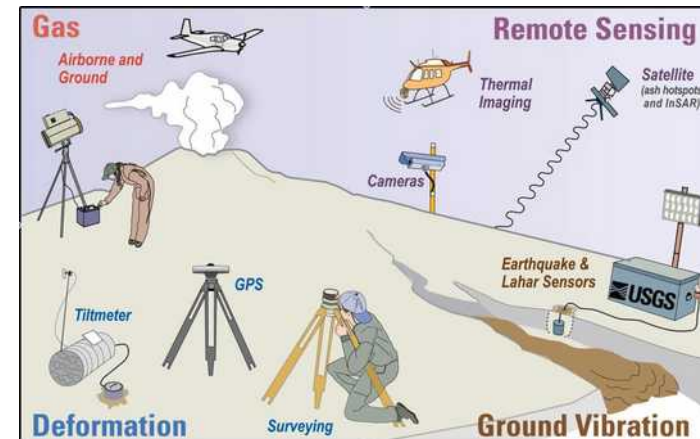

mesure du **radon** et **gaz** (HCl, H<sub>2</sub>, CO et SO<sub>2</sub>)

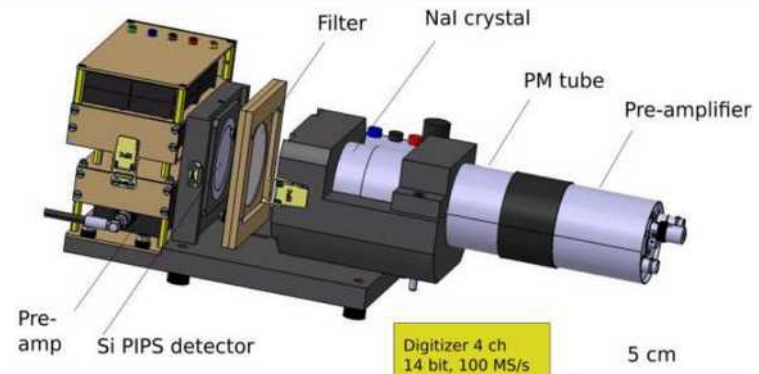

[https://www.uca.fr/medias/fichier/gauthier\\_1664460585717-pdf](https://www.uca.fr/medias/fichier/gauthier_1664460585717-pdf)

[https://www.unisdr.org/files/15761\\_dmographieetrisquevolcanique.pdf](https://www.unisdr.org/files/15761_dmographieetrisquevolcanique.pdf)

<https://uca.hal.science/tel-03394909/>

# Volcanologie

## Test SatloT du volcan de l'Etna (Sicile)

Carte de communication Kinéis

Carte STM32 Nucleo

Capteur de température

Relevé GPS externe

10 sec avec un smartphone

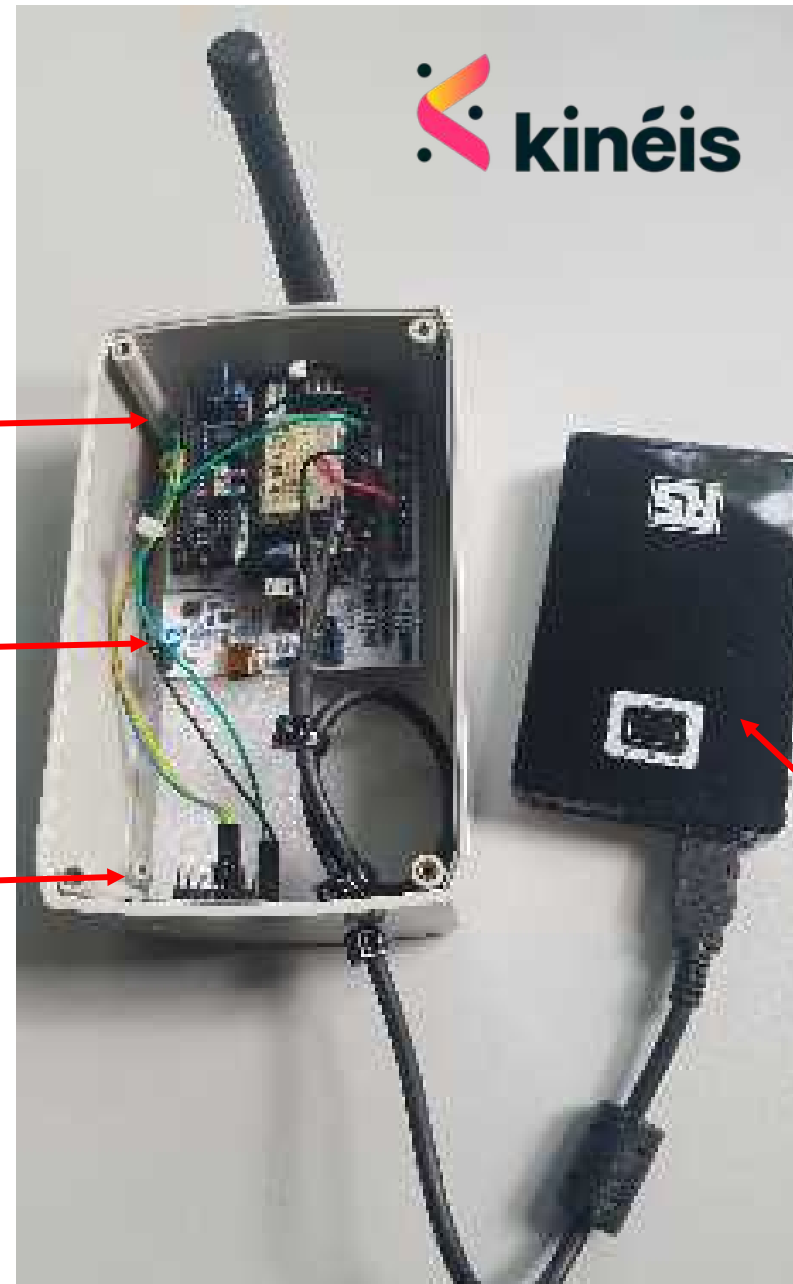

Batterie 5 Volt  
(7000 Ah)

# Volcanologie

## Test SatIoT du volcan de l'Etna (Sicile)



Carte de communication  
Echostar Mobile

Carte STM32 Nucleo

Carte capteurs de gaz (HCl, H2, CO et SO2)

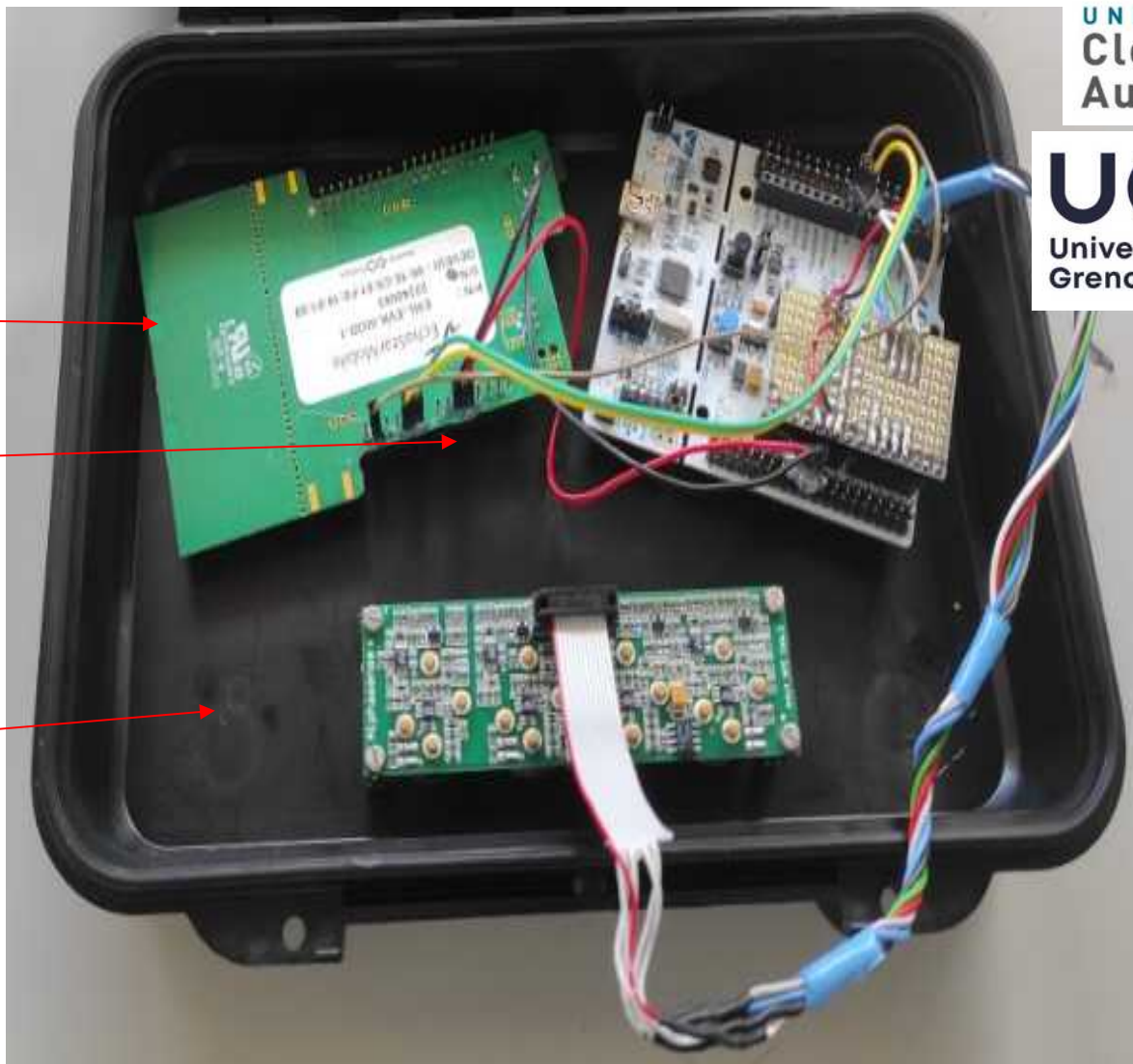

+ batterie de 5 Volt (7000 Ah)



# Joli ! Non ?



# Smart environnement



## Université de Grenoble-Alpes (UGA) LIG-CNRS laboratory

### Skills:

- LpWAN technologies (IoT satellite, LoRa, ...)
- RTK over LoRaWAN
- AI – Tiny ML
- Programming/use of large number of end devices

### Developments & Experimentations

- ThingSat project
- Counting/recognition of animals – IA for birdsong
- Air Quality Station



Cubesat mission



WildCount: Recognizing and counting the presence of humans and animals



Air quality station

Station LORA station in Alpes



Connected groundhog cage



OpenCollar (LR1110)





# Low Power **Global** Area Networks (LPGAN)

- Constellation des satellites (fat ou nano) relayant les messages de terminaux isolés
- Opérateurs LPGAN
  - Lacuna Space, Astrocast, Echostar Mobile, Kineis ...

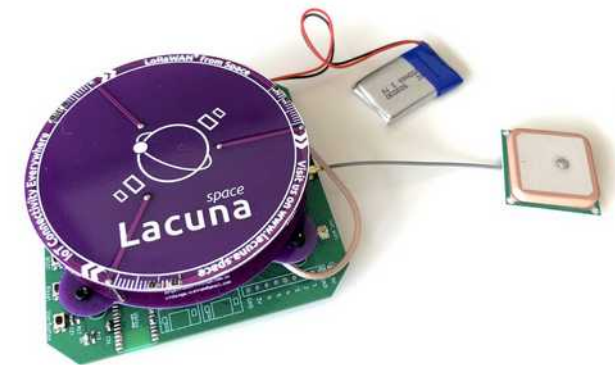
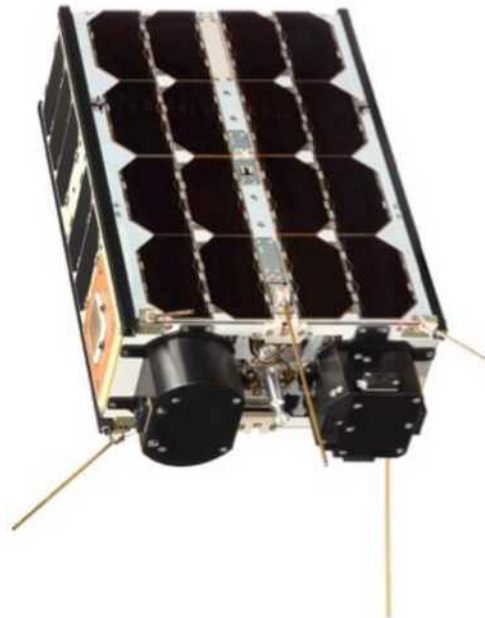

images Lacuna space



# Low Power Global Area Networks (LPGAN)

## Exemple : Kinéis

### Connectivity provider

20 000 active devices

- 2-way communication
- **30-byte** messages
- Low-transmission power (**100mW**)
- Low-consumption, long-lasting batteries
- Native location via Doppler Effect
- **Miniaturized devices**



Global



IoT  
dedicated



Low  
consumption



Easy &  
Reliable

Constellation of 8/24 cubesats  
400MHz (2.4GHz next)



# “New space”: Space for the mass

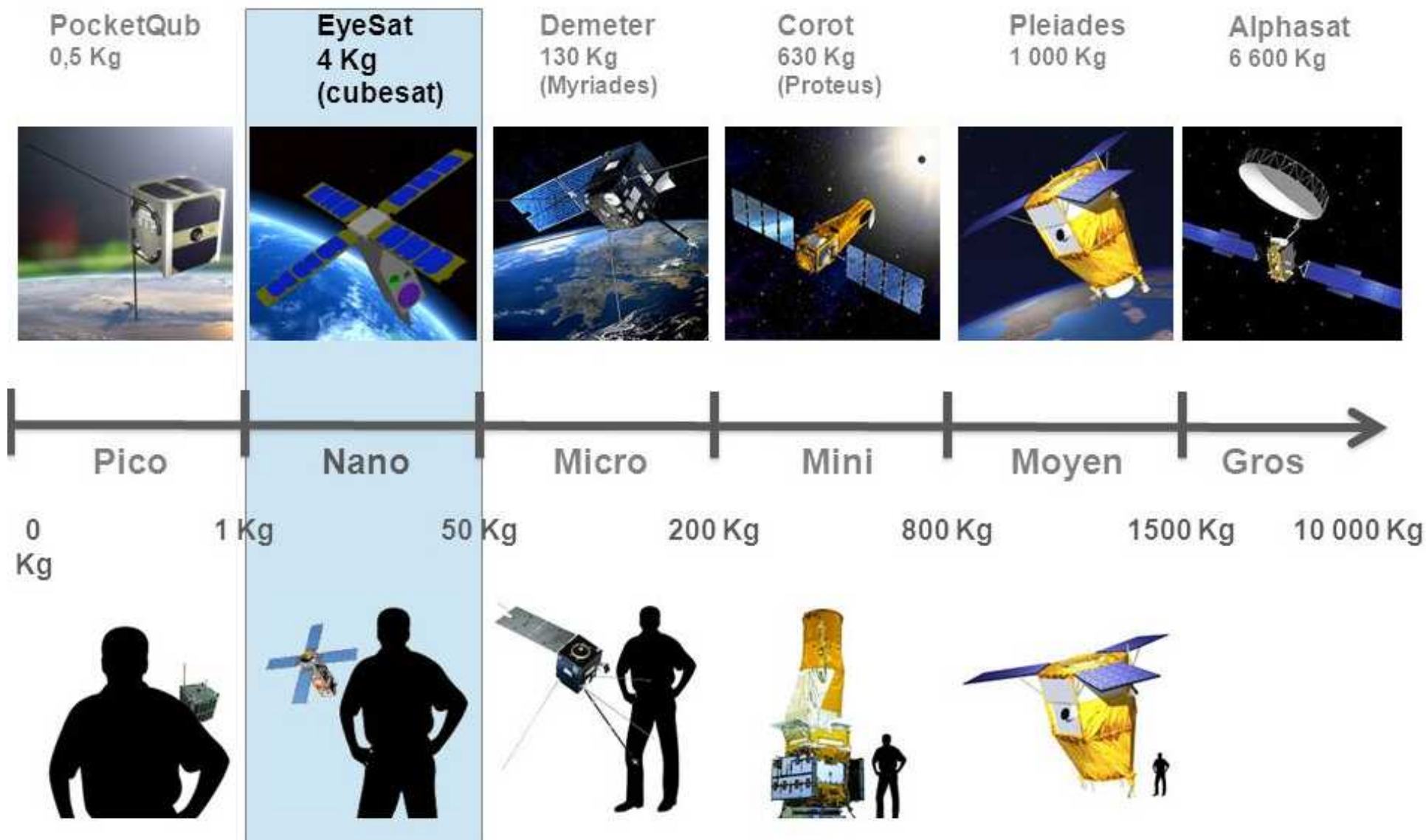

# “New space”: Space for the mass

Cubesats : Agile and “affordable” LEO satellites

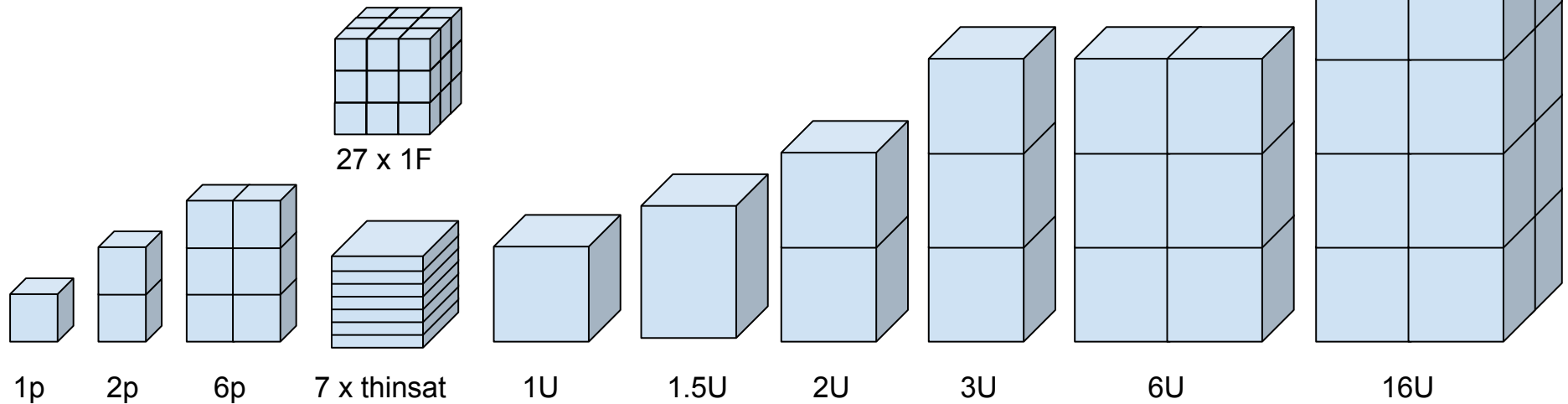
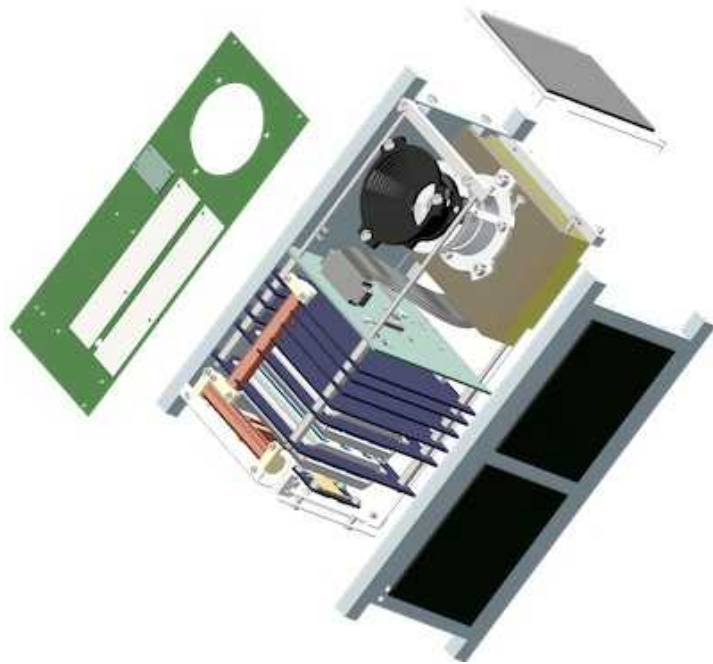



# The Cubesats ecosystem

- Component “off the shelf” (Standardized)
- Time development reduction
- Cost reduction
  - constellation
- Launch Vehicle Sharing
  - *slot & drop model*

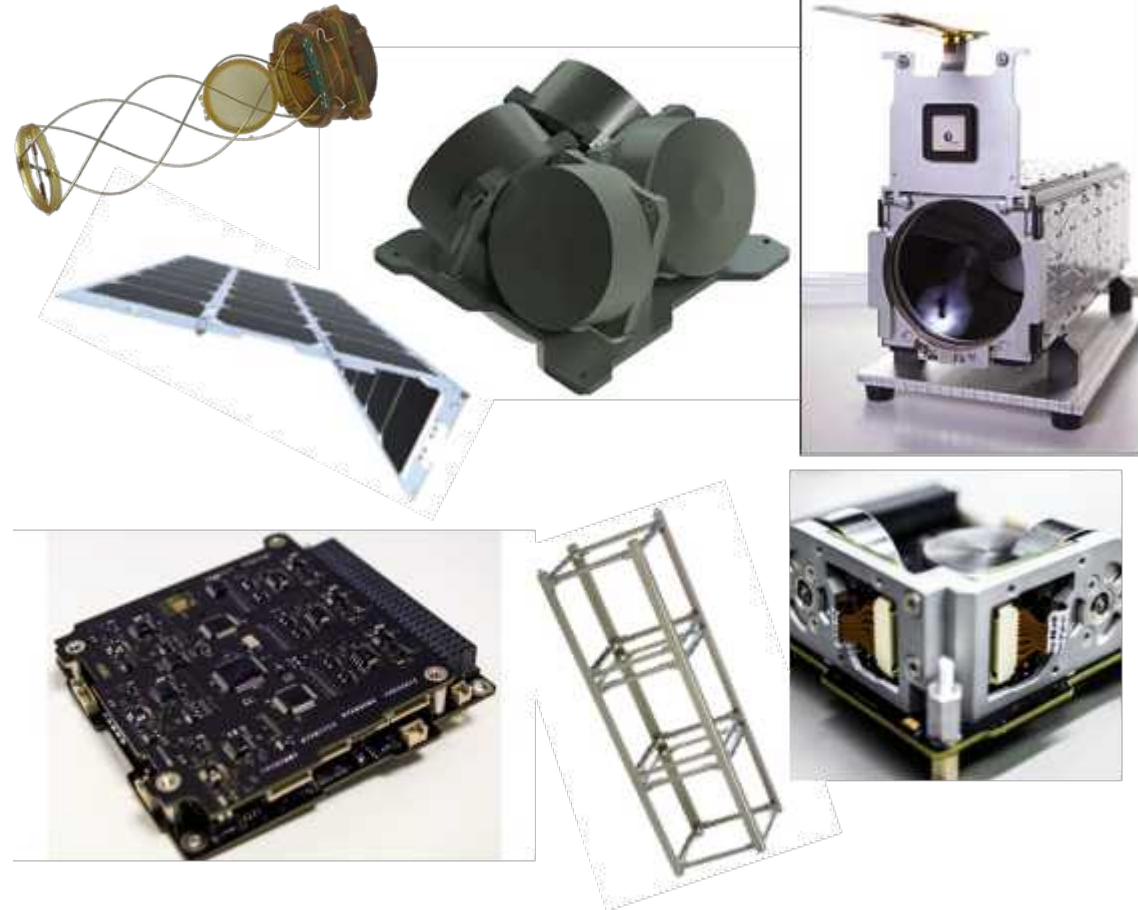

Costs: From 500 k€ for 1U to 5 M€ for 1U



<https://www.cubesatshop.com/>  
<http://www.isispace.nl>

# Low Power Global Area Networks (LPGAN)

- Affordable Sat-IoT (LoRa, LR-FHSS, NB-IoT)
  - part of 6G architecture
- Goal
  - Miniaturized terminals
  - Affordable low power terminals
  - Affordable ground stations
  - Affordable subscription
- License-free sat. communications (ISM bands)
- **“Affordable” cubesats constellations**
- Affordable and massive network of ground stations

# 6G Terrestrial and Non-Terrestrial Networks

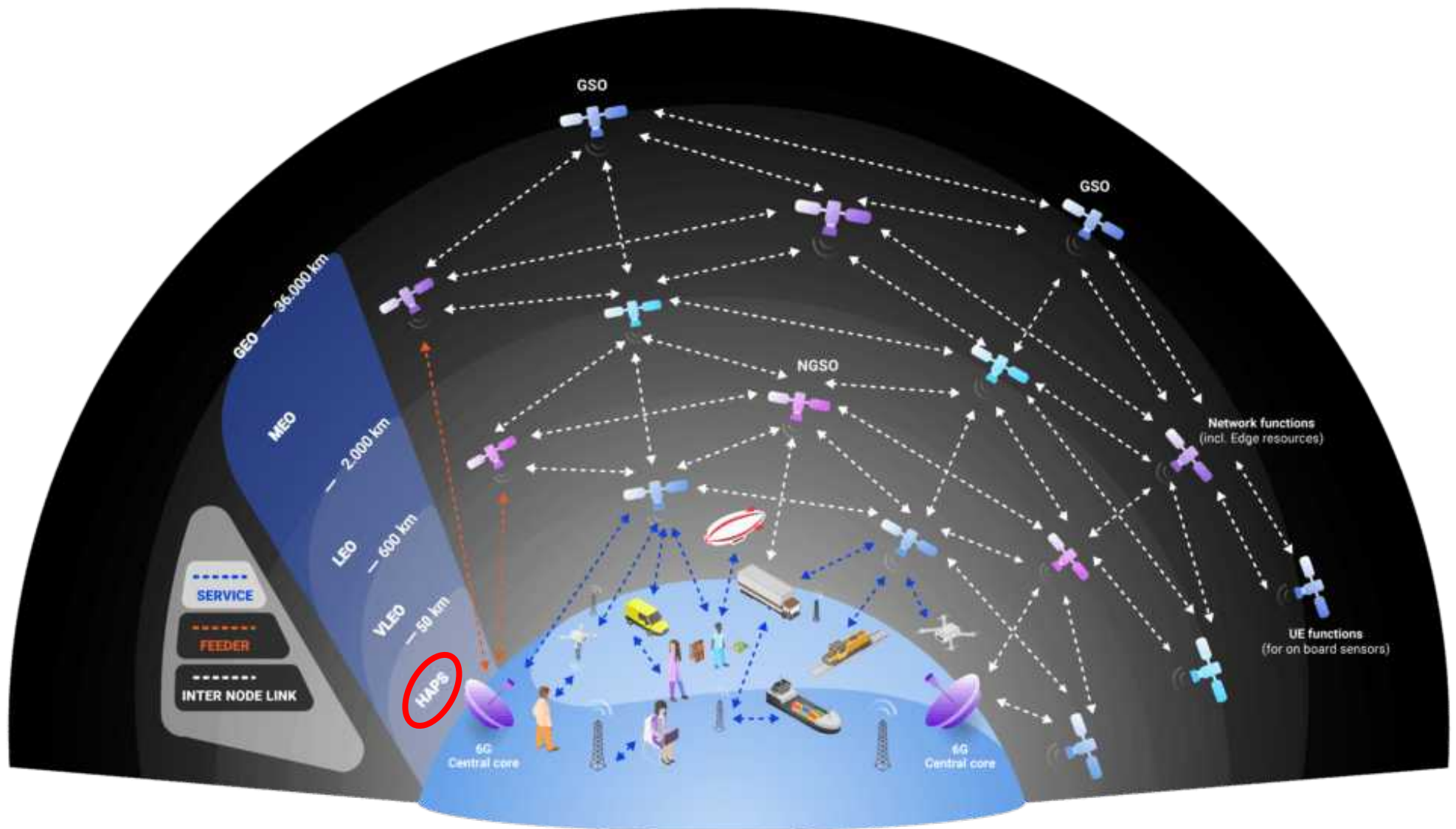



# HAPS : High Altitude Pseudo Satellites | High Altitude Permanent Systems

UAV plus lourd ou plus léger que l'air

Zone blanche, emergency networks, tactical networks ...

Relai 5G

@ 20000-25000 m (-56.5 °C) d'altitude pendant qq semaines

Premiers tests de communication: Rwanda, Japon, Canaries ...

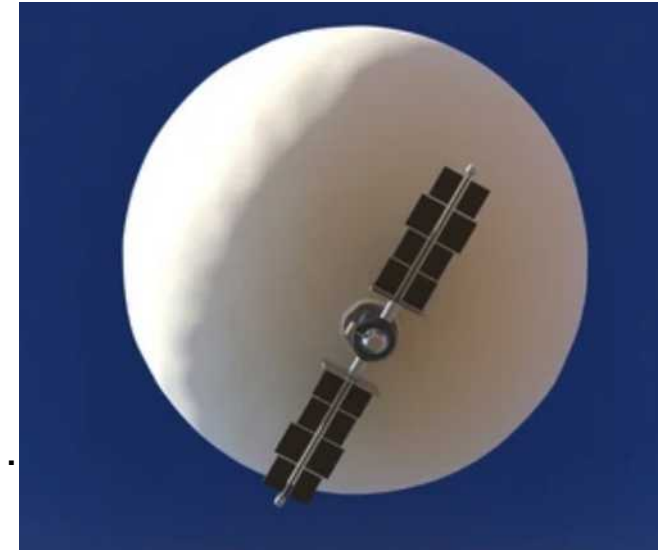

# ThingSat : Research vehicle for space com with LoRa + LR-FHSS

## LoRa/LR-FHSS link characterizations

- UL: Rx only LoRa sniffer
- DL: Tx only LoRa Beaconer

## LoRaWAN applications on test cases

- Repeater (with filtering)
- Store-carry-and-forwarder GW
- Time distribution synchronization (*hard discount* du LEO-PNT)
- Two-way ranging

## Test cases

- Monitoring helium bottles @ vessel (Air Liquide Maritime)
- Firm farms (Université Polynésie Française)
- Glacier temperature sensors @ Svalbard (IPEV)
- Microclimate for I2HM (Malaria @ Cameroon) UY1
- EWSS, SAR, AIS, Radio amateur SMS
- Space debris (*Beacon+Status*)

# 525-km LEO LoRa GW

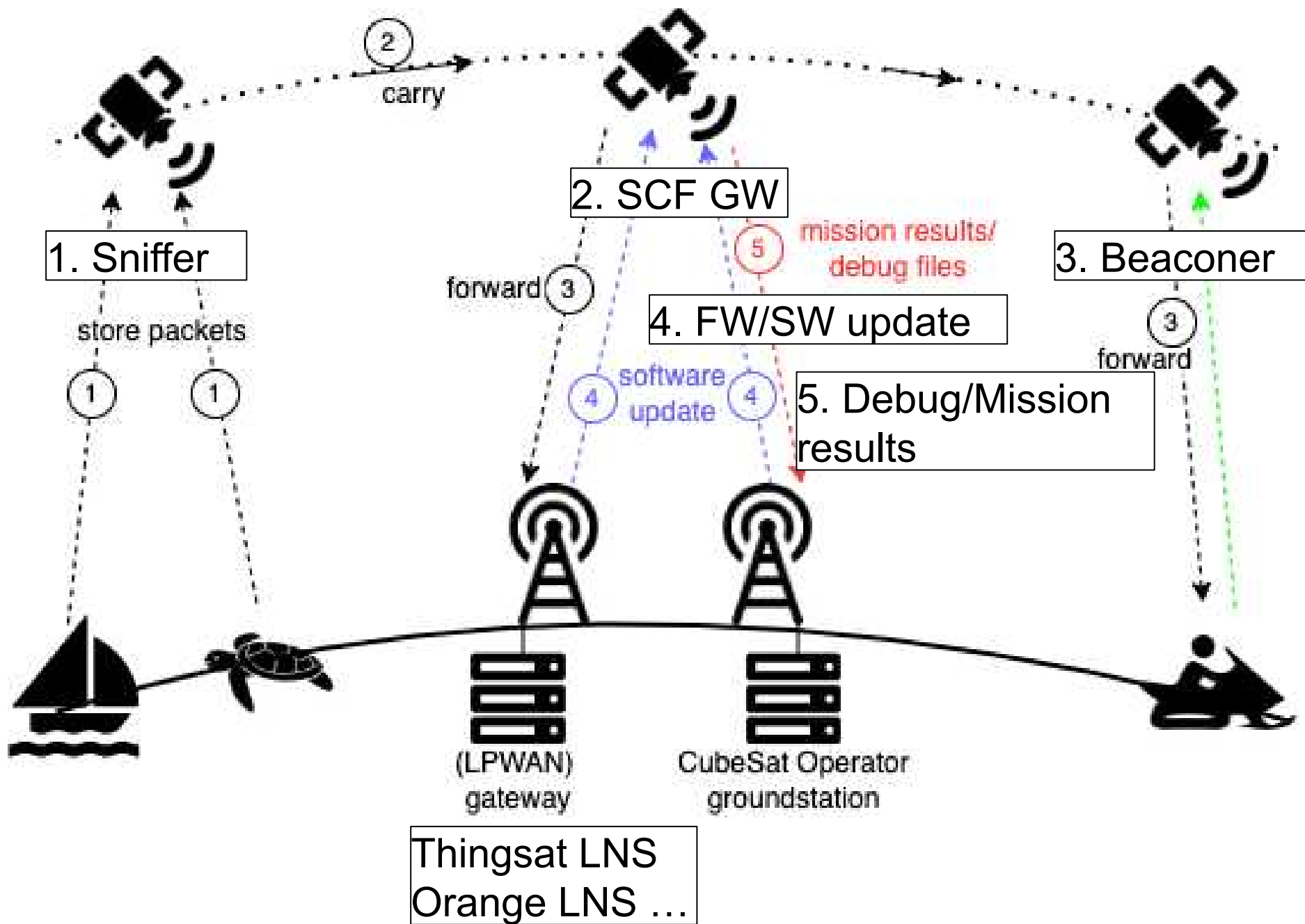



## Delayed Tolerant Network

How does it work : Store-Carry & Forward LoRa frames

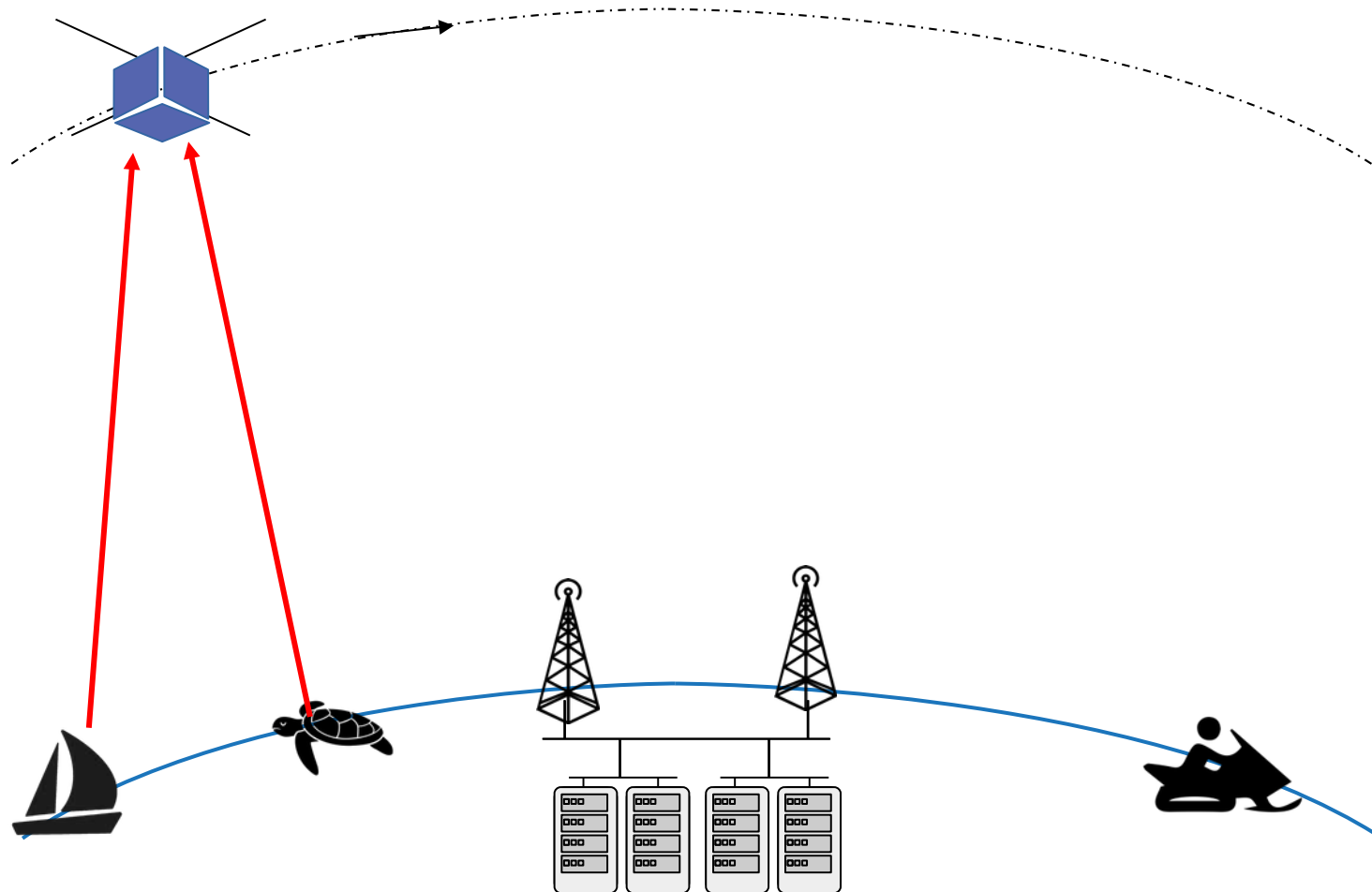

# Communication principles for IOT

## Delayed Tolerant Network

*CubeSat is a data « mule »*

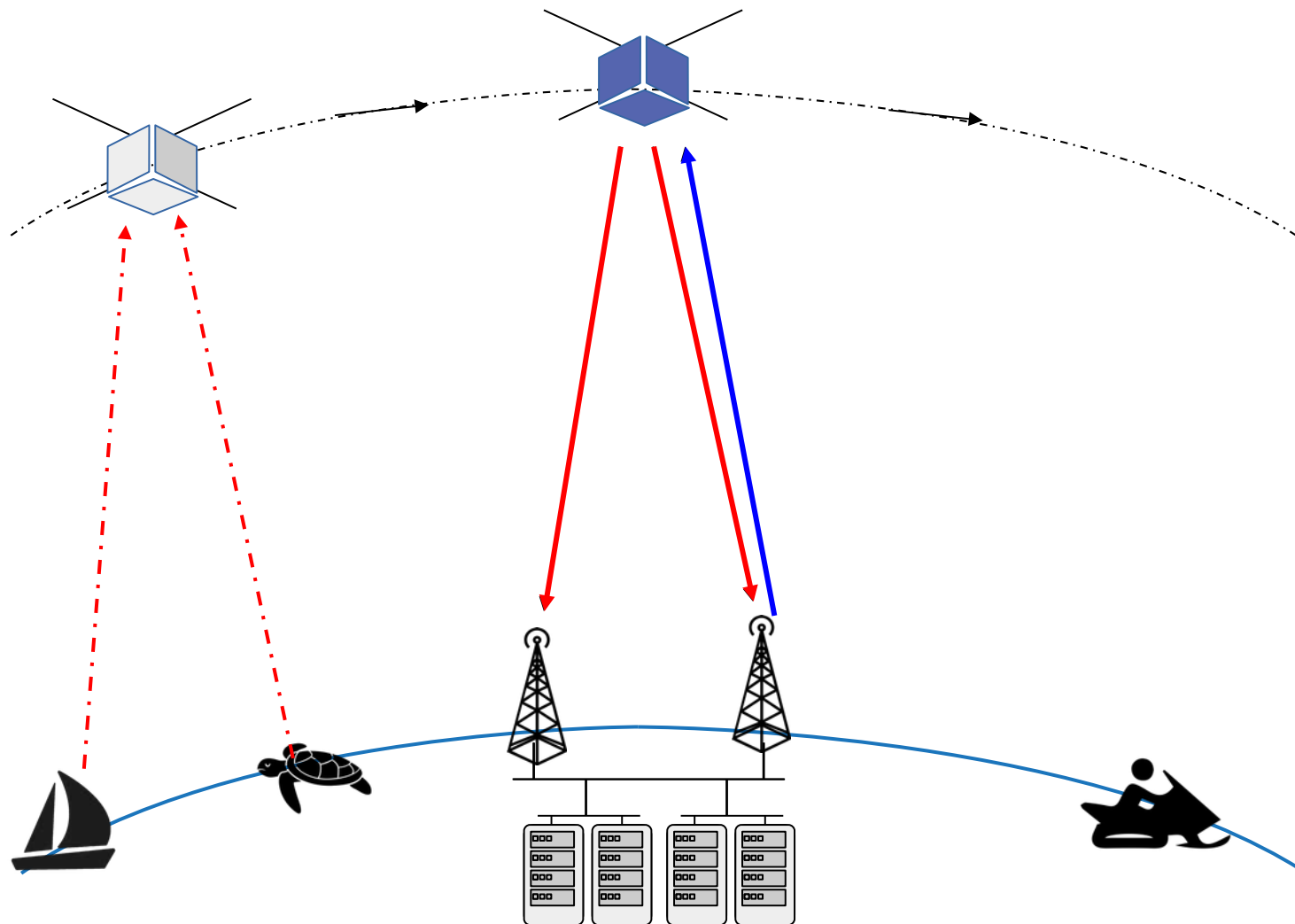

## Delayed Tolerant Network

How it work : Store-Carry & Forward LoRa frames

*CubeSat is a data « mule »*

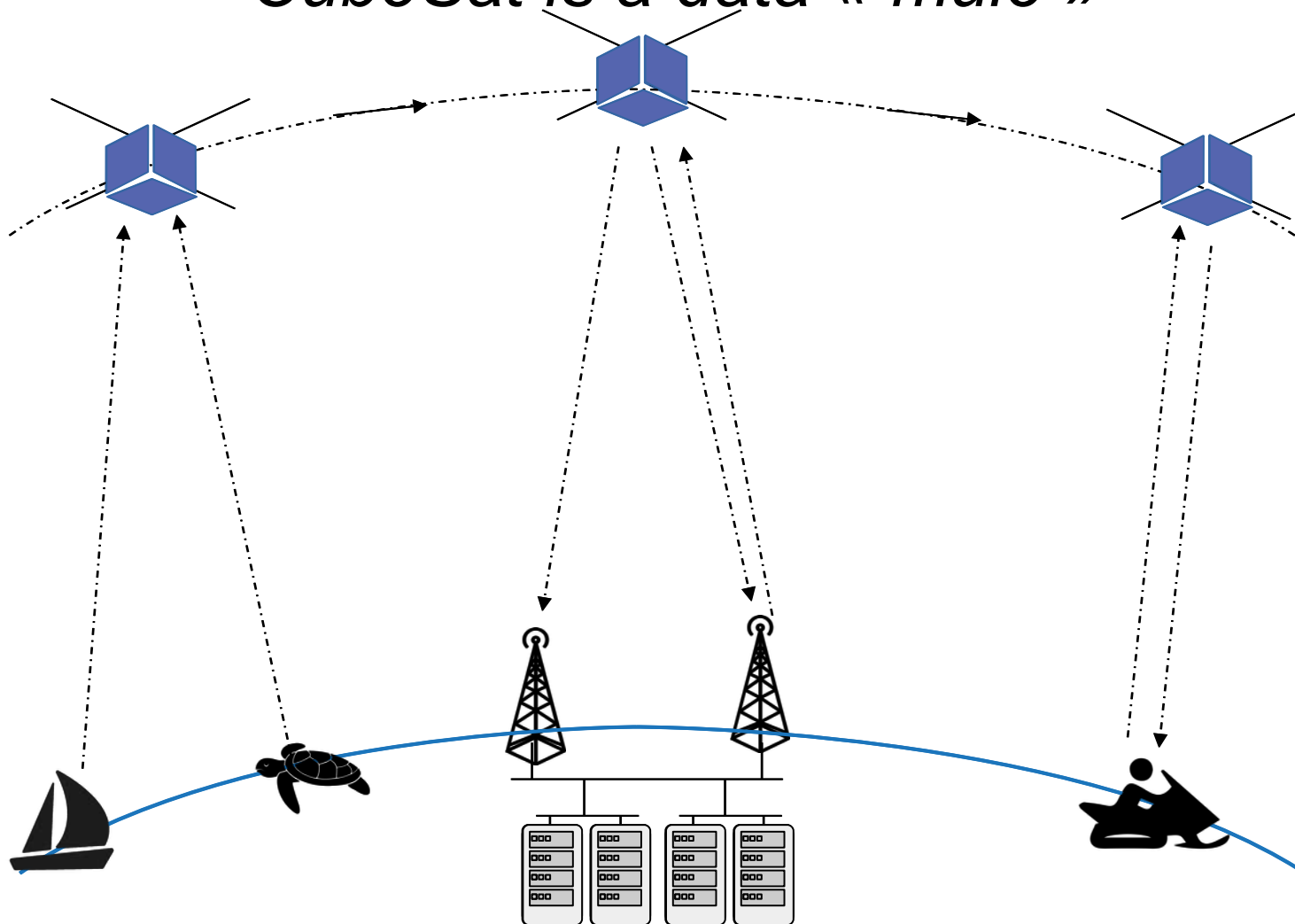



# Communication principles for IoT Delayed Tolerant Network

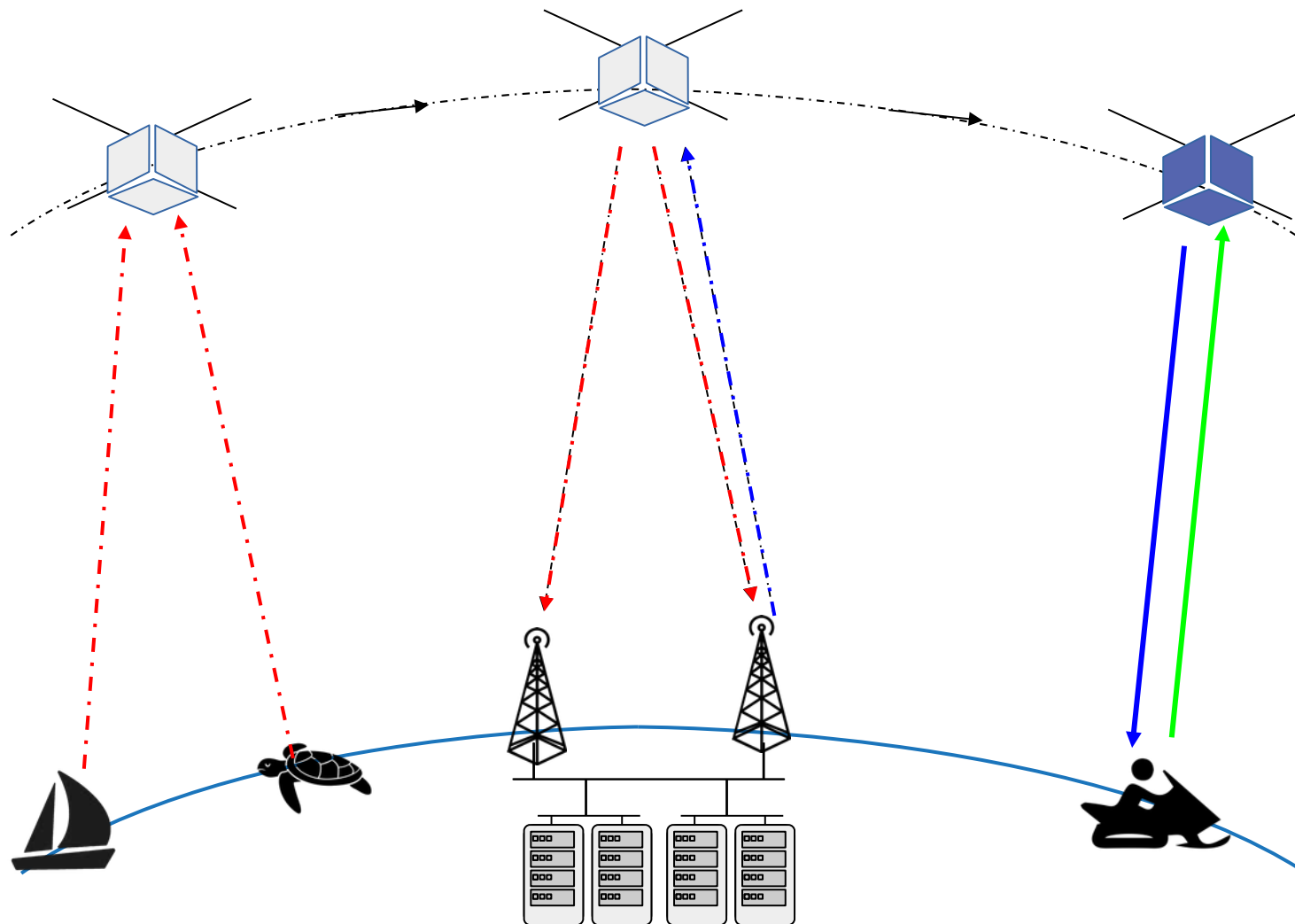

# Low-Power and Very Long Range WAN LoRa Experiments from High Altitude Balloon





# Very long range radio tests from HAB

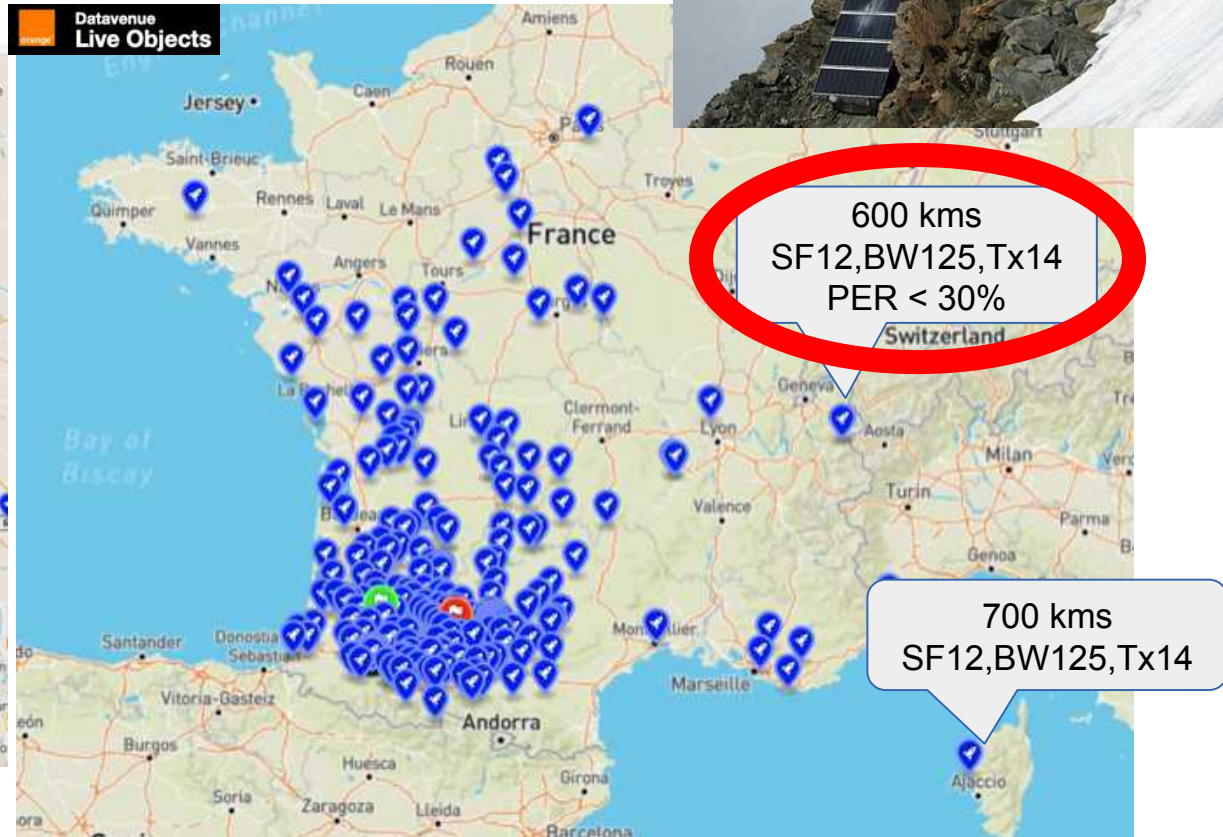
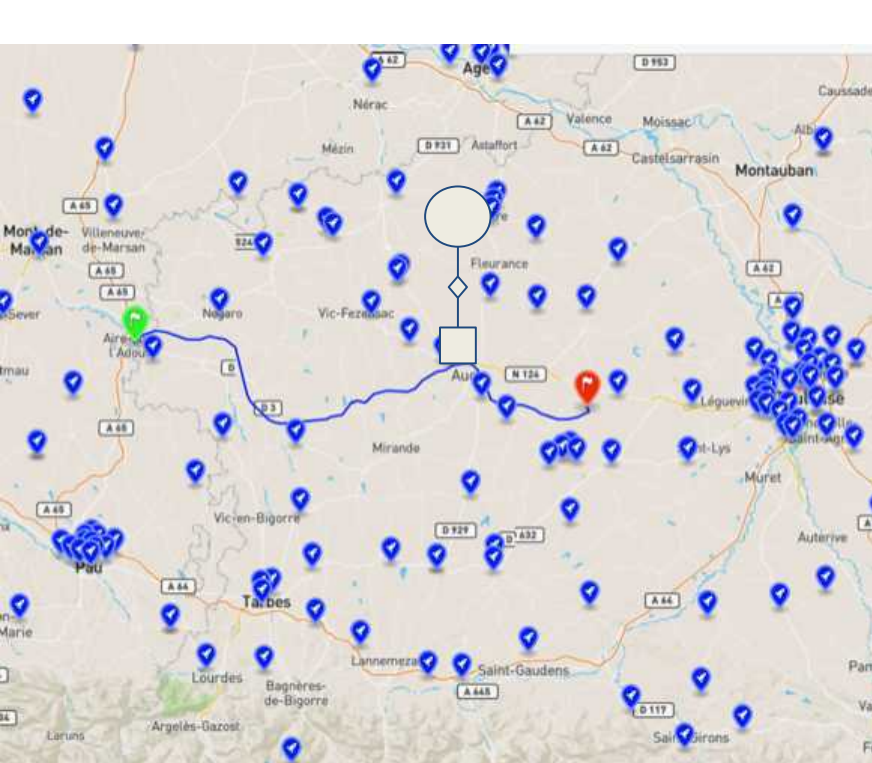



# Thingsat board detail

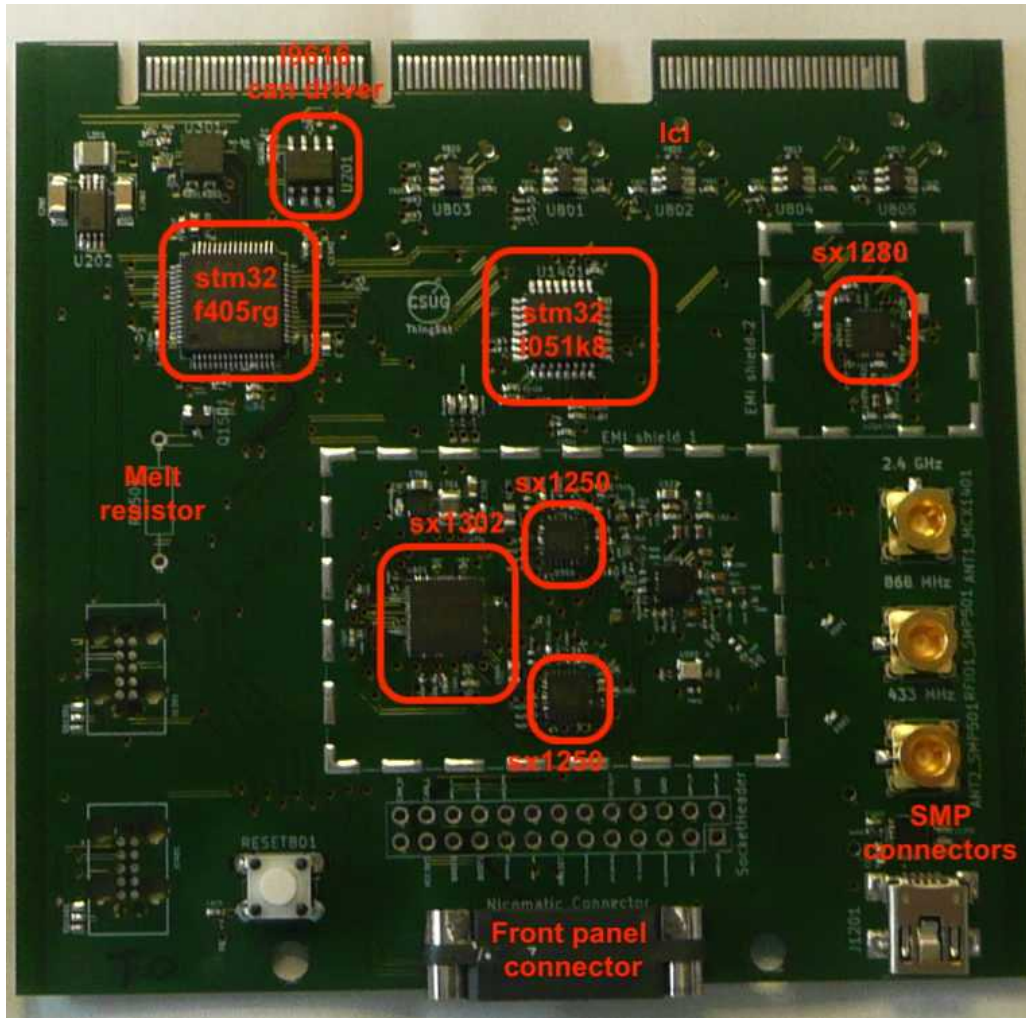

- RPI → automotive-grade STM32  $\mu$ C
- SX1302 design copy/paste on a spatial PCB
- Linux source code → RIOT-OS port
- SatRev Edge connector
- CAN Bus
- Front panel connector (Nicomatic) for testing and flashing

Semtech SX1302+SX1250: LoRa eu868 + eu433  
 Semtech SX1280: ism2400

# From Prototype to Flight Model

Breadboard Model  
Nucleo + DevKit

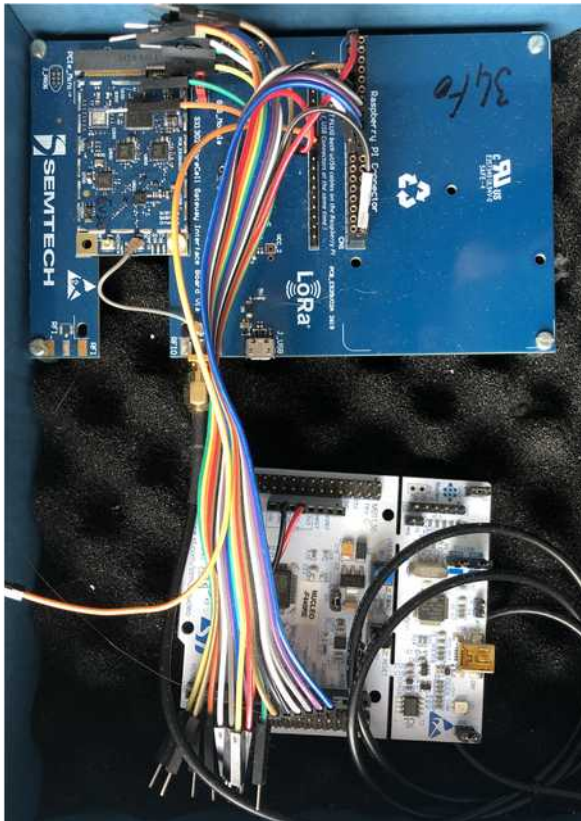

Engineering Model



Flight Model

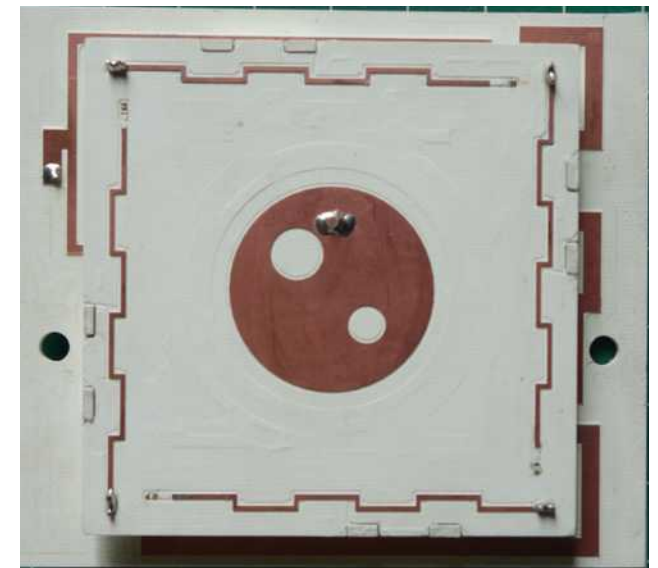



# ThingSat : electronical board + antenna

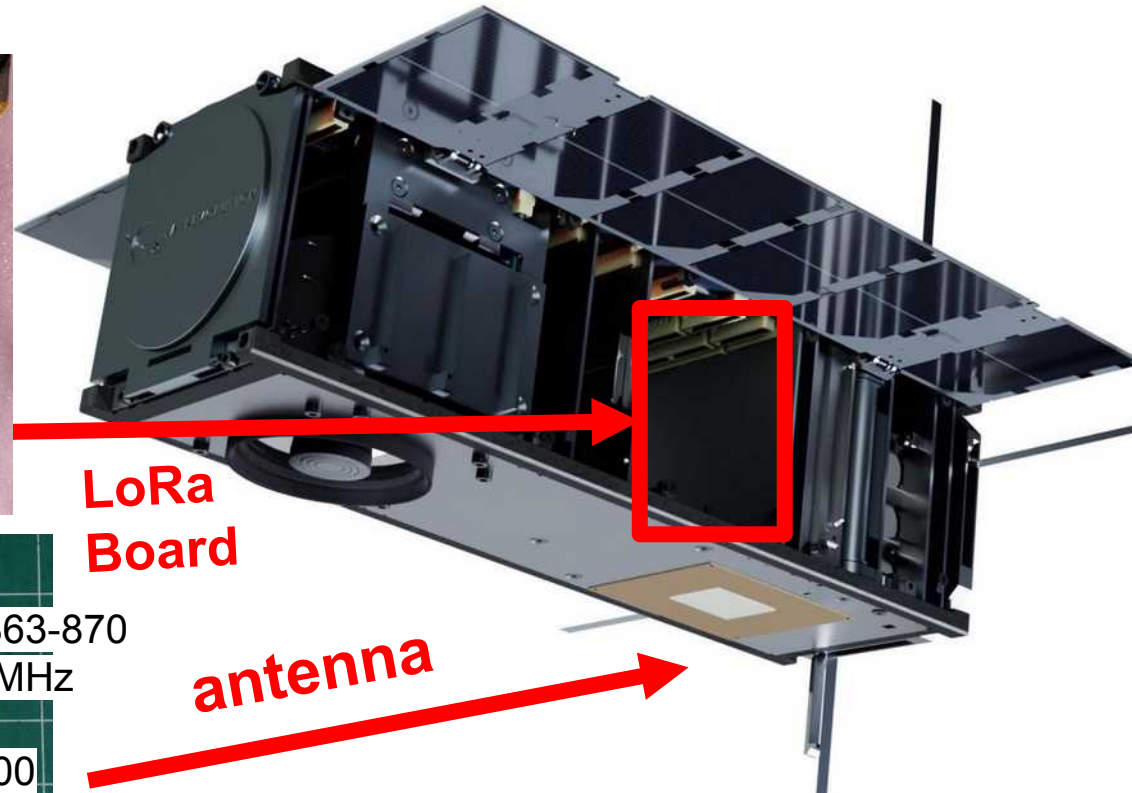

**LoRa  
Board**

**antenna**

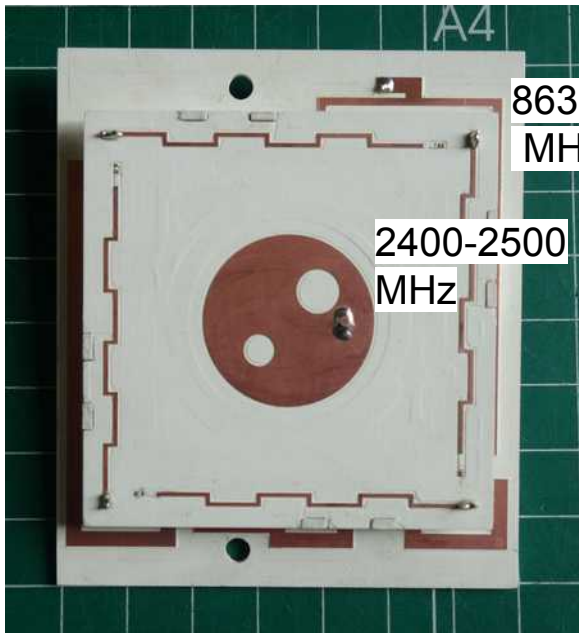

863-870  
MHz

2400-2500  
MHz

Contraintes

puissance carte electronique

taille (ex. antenne 8mm épaisseur, 10x10cm max)



# Development Platform (@ Home during Covid19)

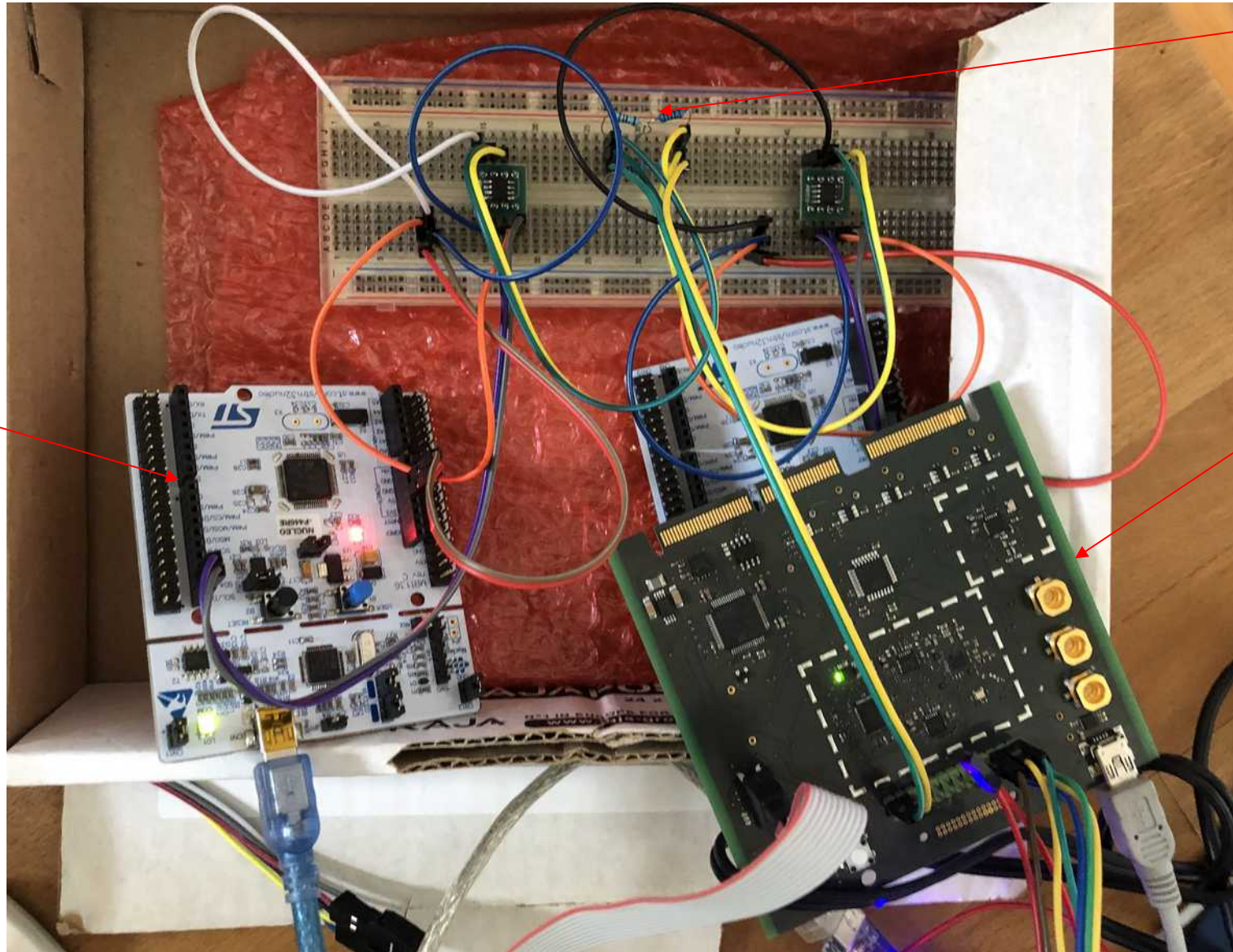

CAN Bus

Engineering Model

OBC Emulator

# ThingSat FM integration into the STORK-1 Platform

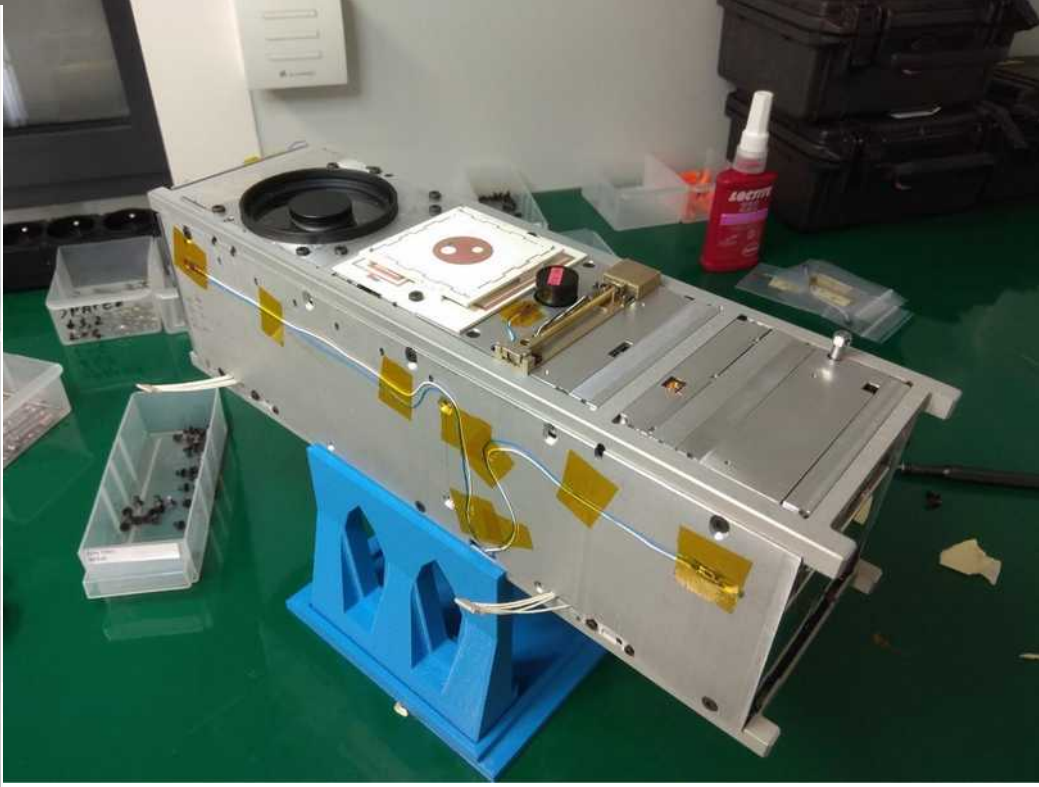
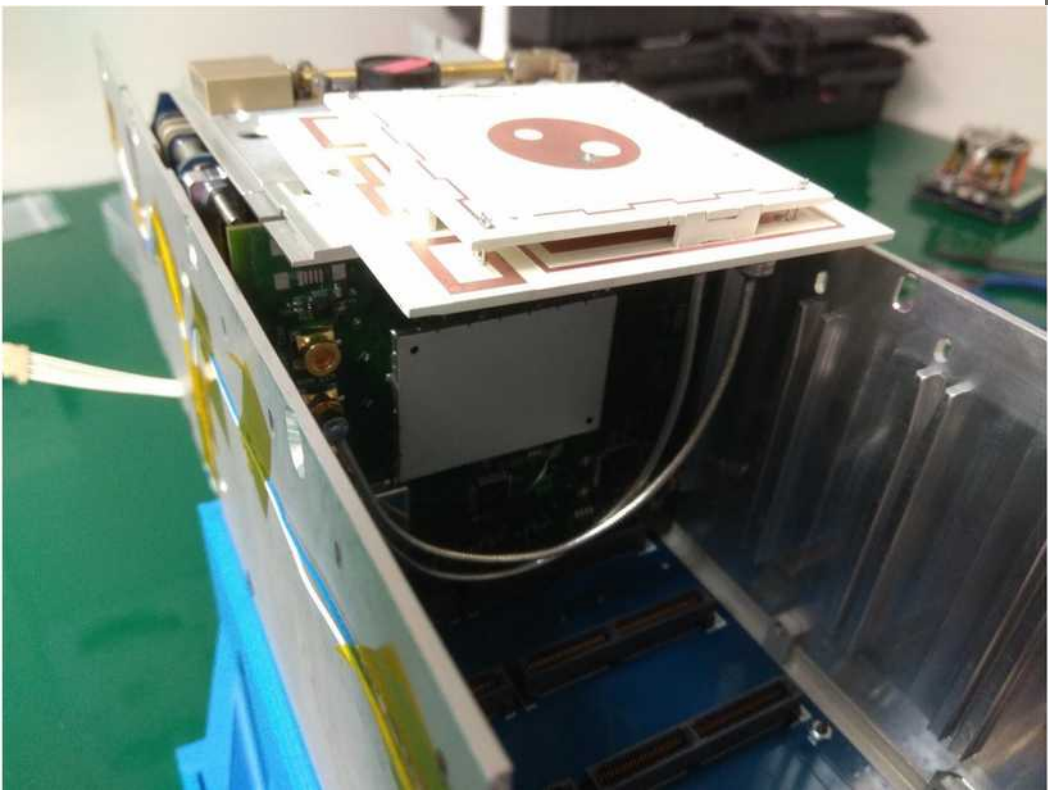



# Shipping to transporter(s) ~~Momentum~~ then D-Orbit





# Payload #1 now in orbit

- January 13th, 2022, 15:25 UTC on SpaceX [Falcon 9 Block 5](#) Transporter 3 SSO Ride. ([Rewatch](#))
- 105 spacecrafts inside, 3 times a year, deployment over weeks



# Mission 2 : Thingsat payload #2 @ ~~SOWA-2~~ STORK-8

Launch SpaceX Falcon 9 Rideshare: ~~October 2024~~ April 2024

Integration in April 2024

Funding : Requea; Labex Persyval, SatRev

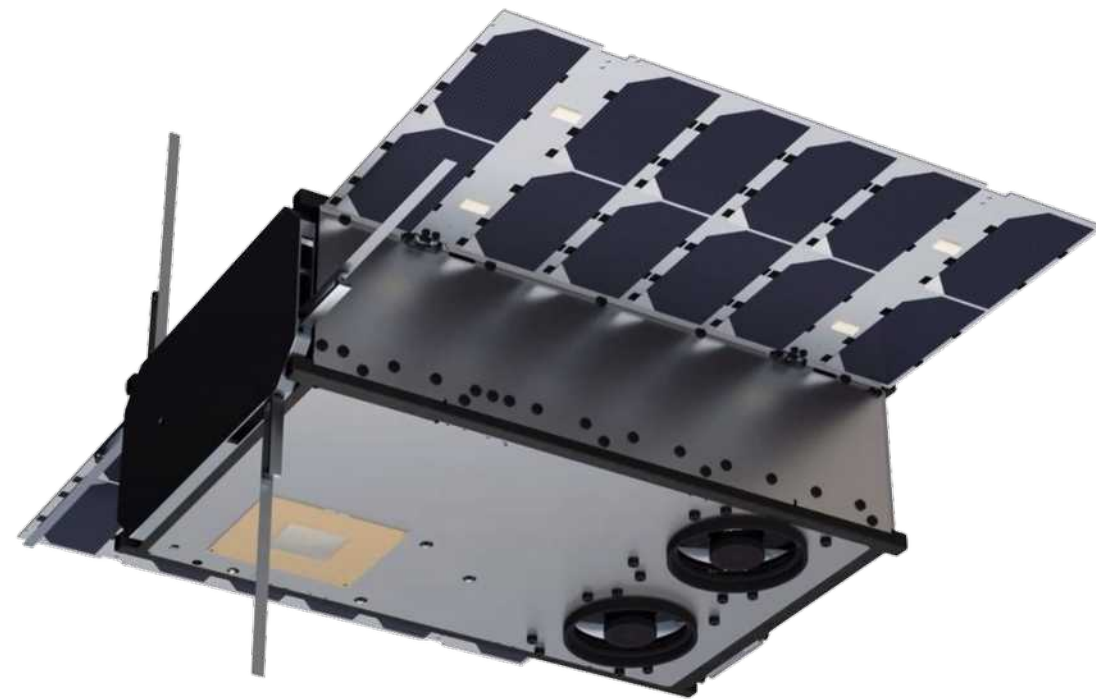
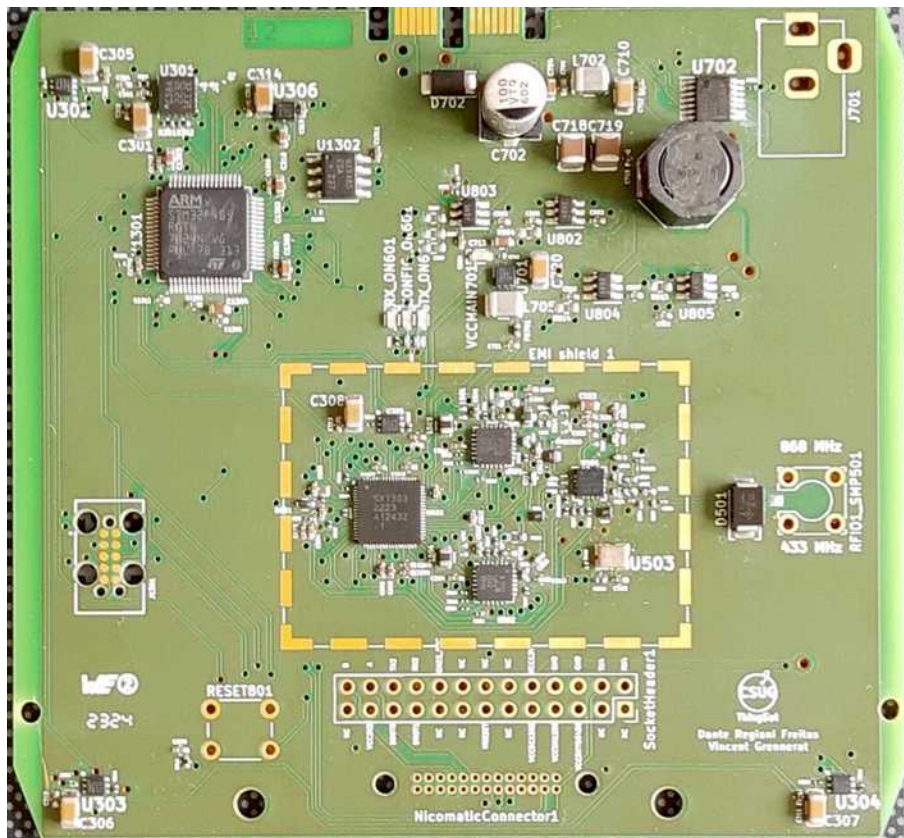

192 KB RAM  
 Firmware ~250 KB FlashRAM



# New space qualification : Test, Test and Test

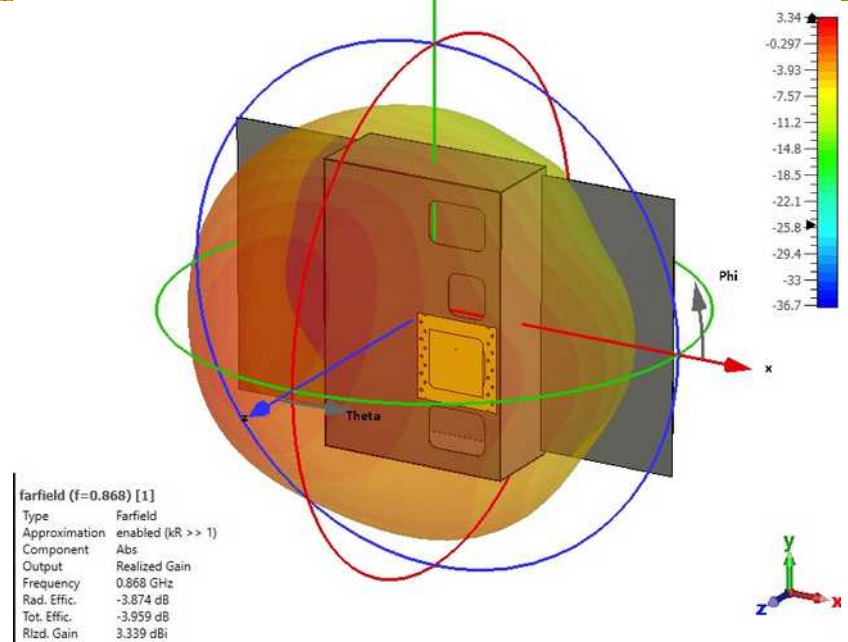



# Mission 3 : Thingsat payload #3 @ Nymph (CSUT)

Launch 2026

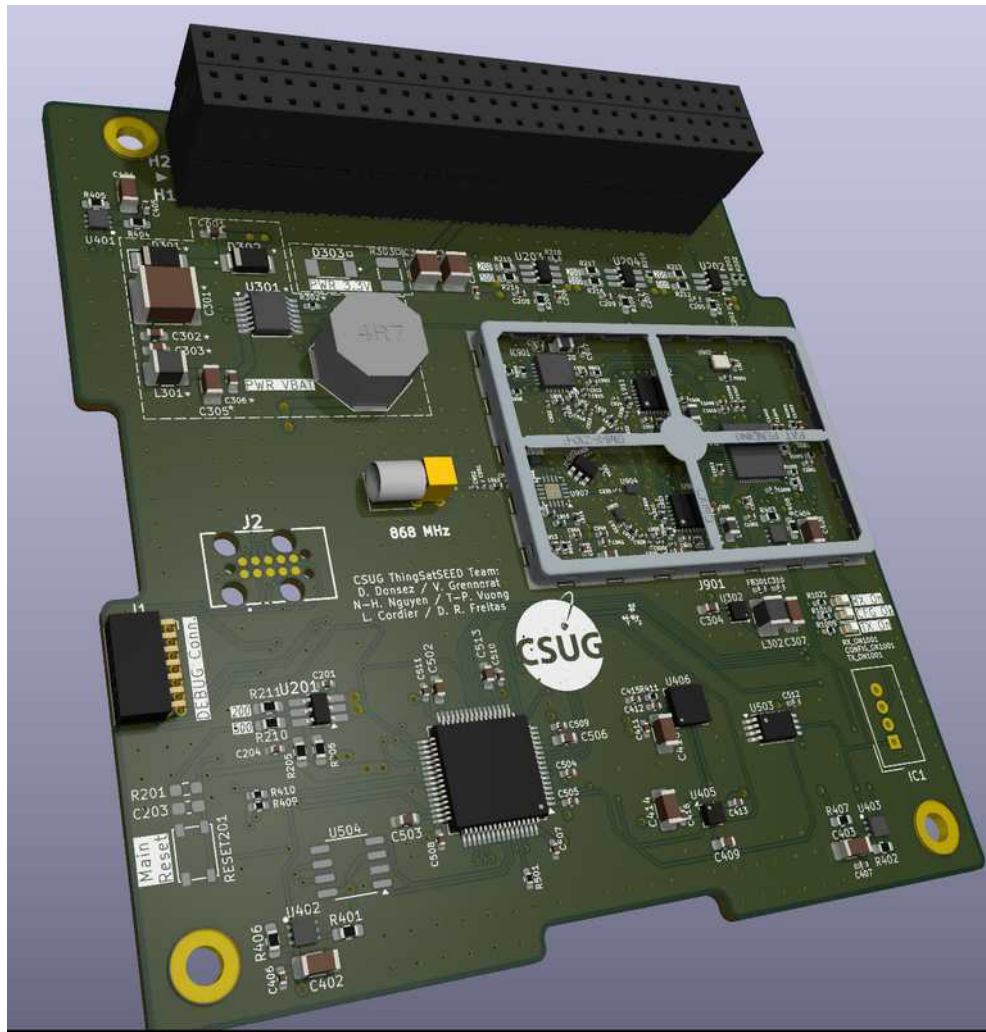

# New space qualification : Test, Test and Test

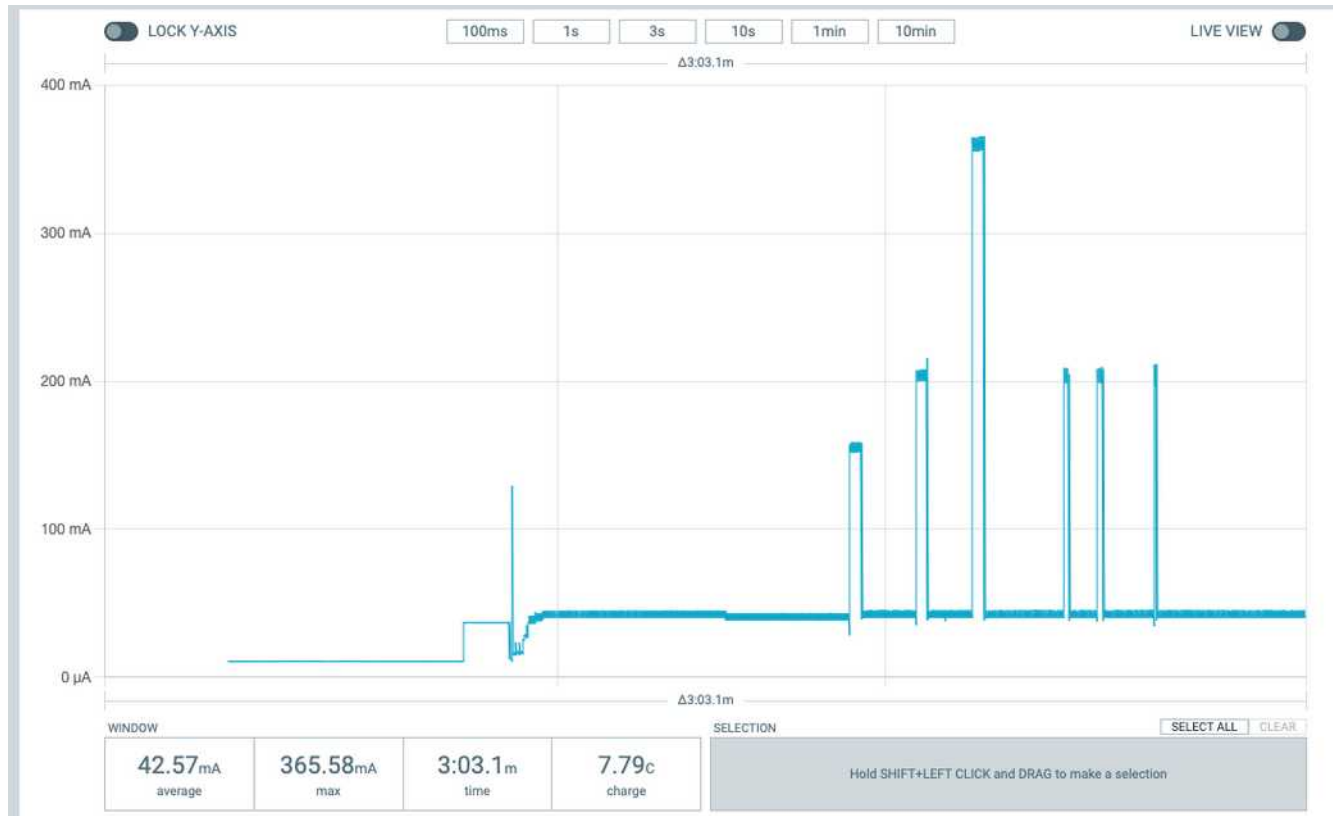

VCC = 5V0

28 mA (peak 28mA at boot) in standby,

55 mA while the SX1303 is started,

70 mA during a frame reception (RX),

84 mA (peak 106 mA) during a frame transmit (TX) at 12 dBm (RFPower)

118 mA (peak 161 mA) during a frame transmit (TX) at 20 dBm (RFPower)

214 mA (peak 320 mA) during a frame transmit (TX) at 27 dBm (RFPower)

66 mA (peak 83 mA) during a frame transmit (TX) at 0 dBm (RFPower)

# Global Architecture

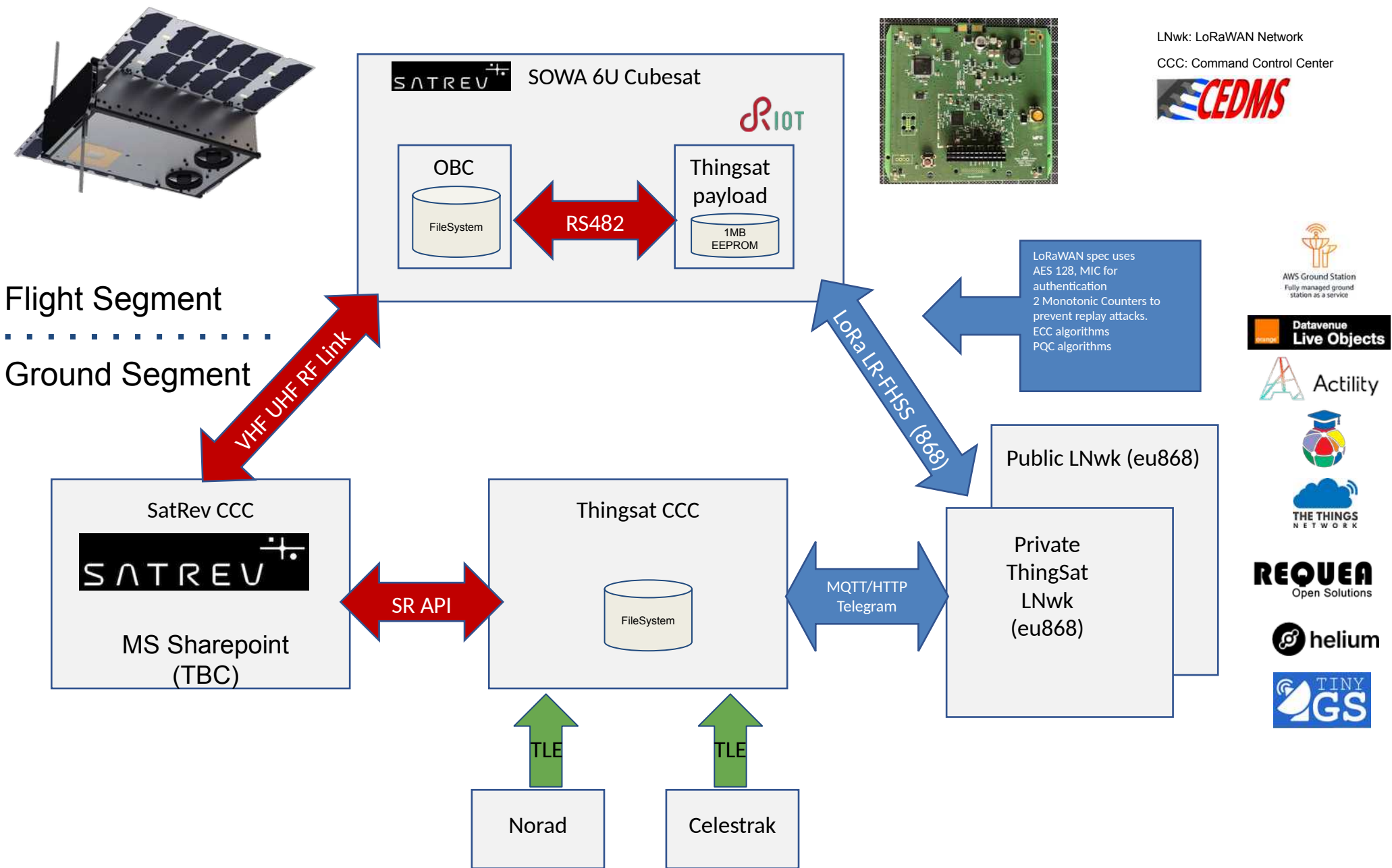



# ThingSat Firmware

## Requirements

- MCU STM32
- Open Source (Active community & INRIA leadership)
- Small footprint
- Multithreading
- Network drivers architecture (incl LoRaWAN)
- **Firmware Update Over The Space**



## Thingsat firmware development (inherited from Thingsat @ Stork-1)

- SX1303 driver upgrading
- SX1262 driver upgrading (for LR-FHSS)
- semtech-loramac upgrading (for LR-FHSS)
- *Basic Modem porting*
- Protobuf over RS485 UP4 API
- SUIT over Protobuf over RS485 UP4 API
- Scenario engine
- TLE library (Orbital calc.) for blacklisting “sensible” earth areas
- *MEMS drivers*
- *TFLite integration*

# New Research Topics

- Firmware Update Over The Space
  - Femto containers
- (Tiny) Machine Learning @ Space
  - Cubesat attitude monitoring
- Delay tolerant routing over LEO cubesat constellation
- **Secure communications over LoRaWAN**
  - **Asim crypto for DigSig (Elliptic Curves)**
- **Post Quantum Cryptography (PQC)**
- **Positioning into extra-planetary cubesat swarms**
  - **Tiny Atomic Clock on board (20 cm<sup>3</sup>)**

Next step : Ranging into a  
satellite/HAPS swarm  
with LoRa



# Conflict GPS jamming impacting LEO satellites



<https://www.gps.gov/cgsic/meetings/2024/humphreys.pdf>

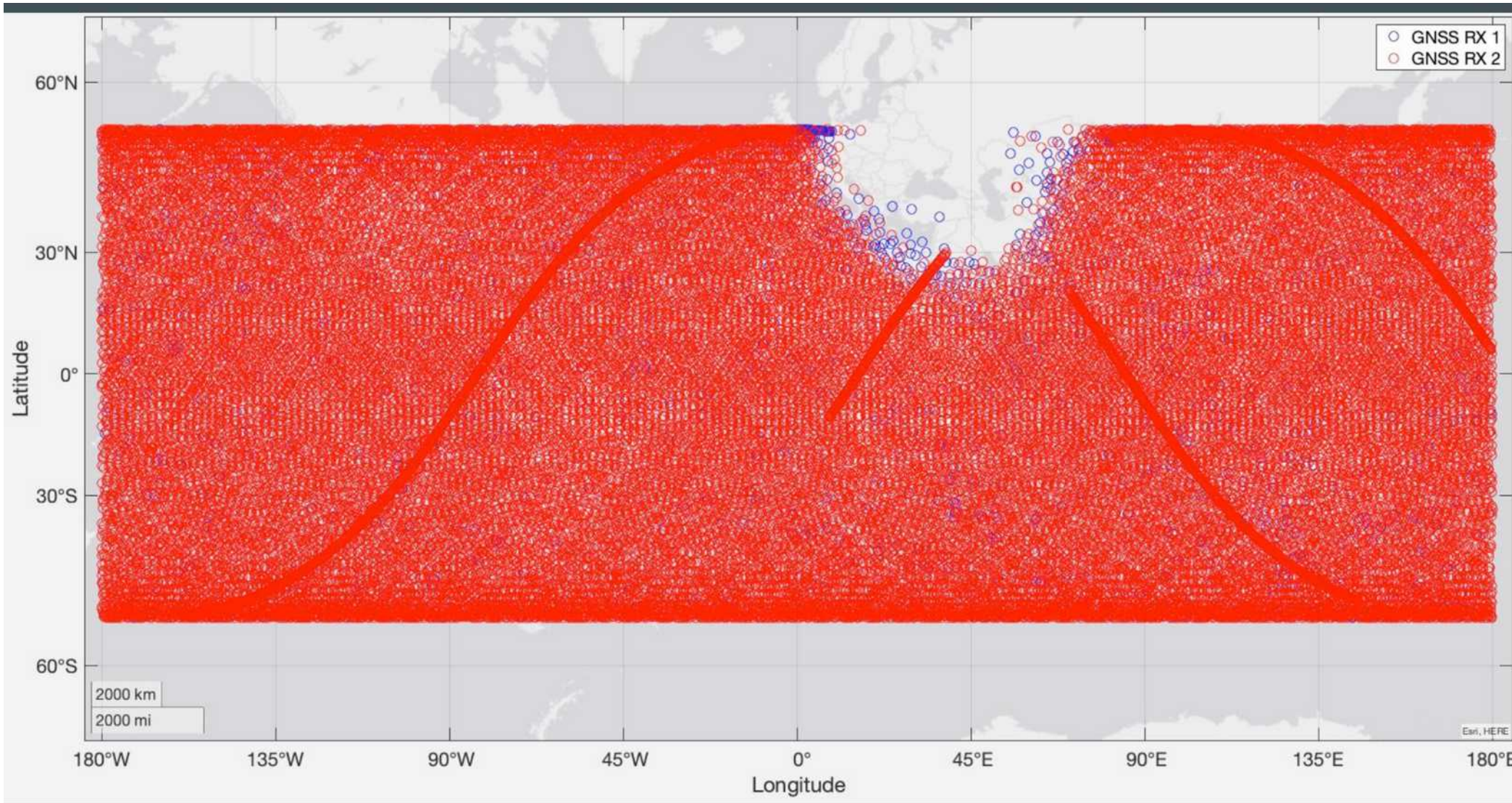

# Resilient positioning

## Broadcasted Two Way Ranging

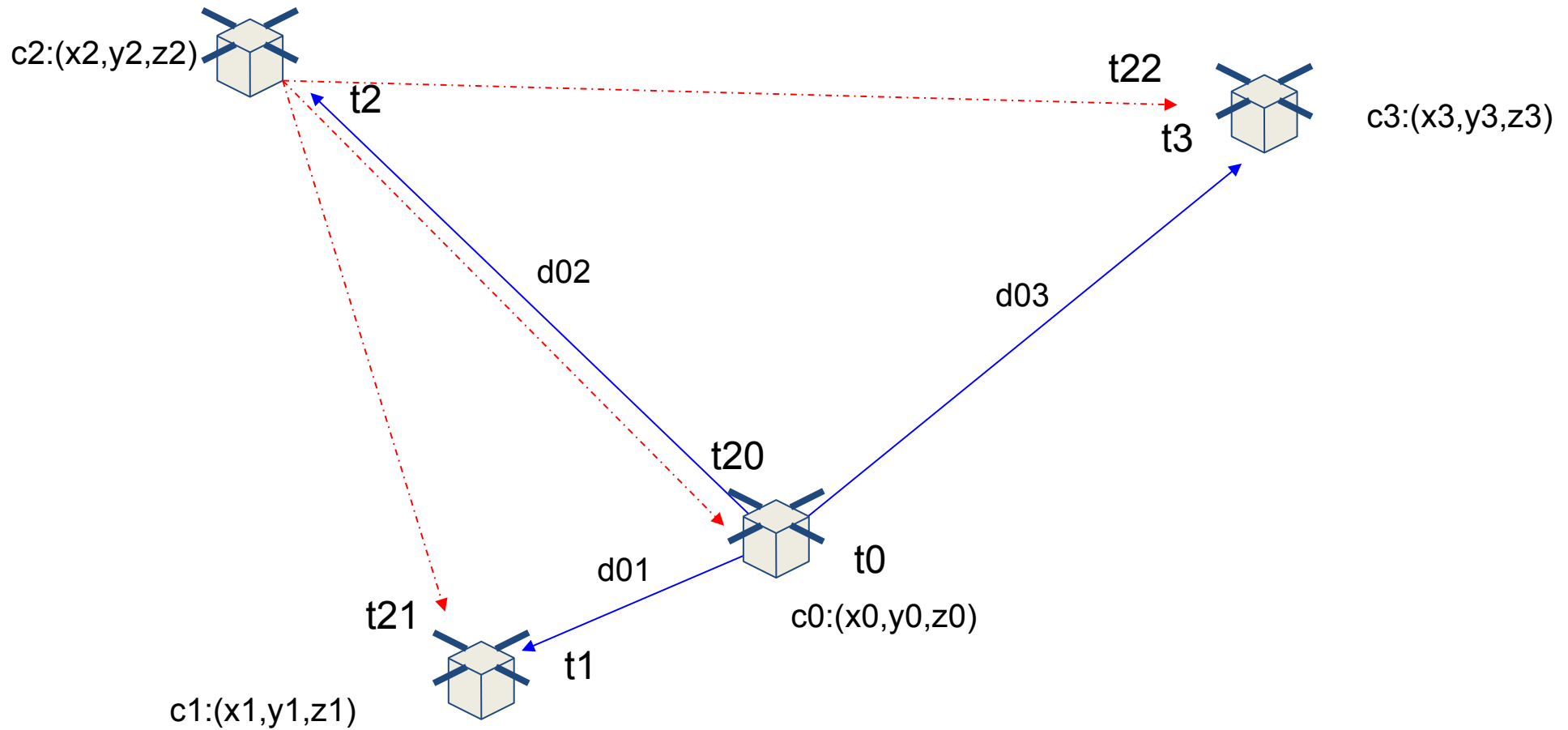

$v=299700 \text{ km/s}$

# Resilient positioning

## Broadcasted Two Way Ranging

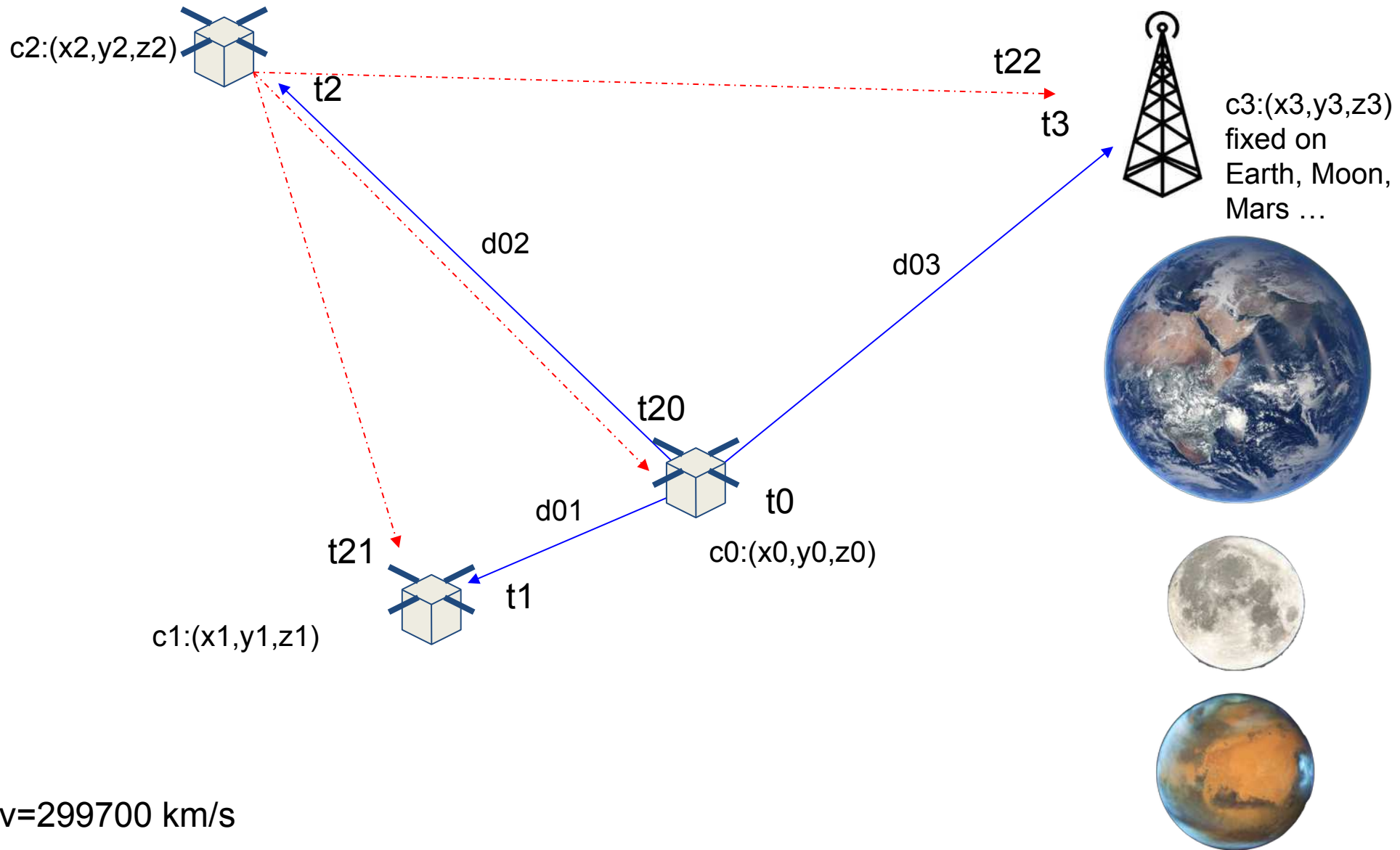



# Resilient positioning

## Broadcasted Two Way Ranging

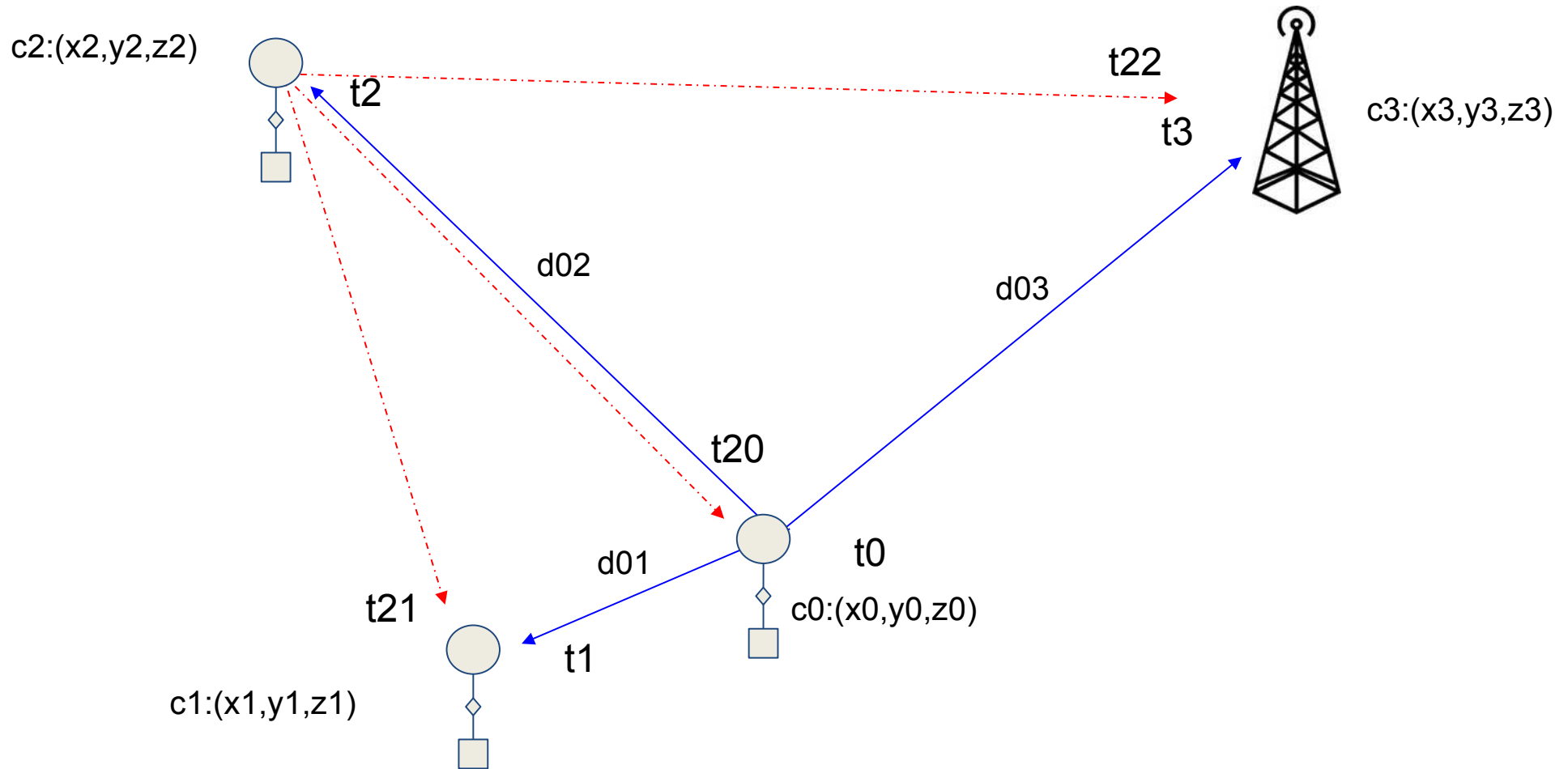

$v=299700 \text{ km/s}$

# Testing Broadcasted Two Way Ranging with LoRa and Strato Balloons



# CubAClock EM then FM

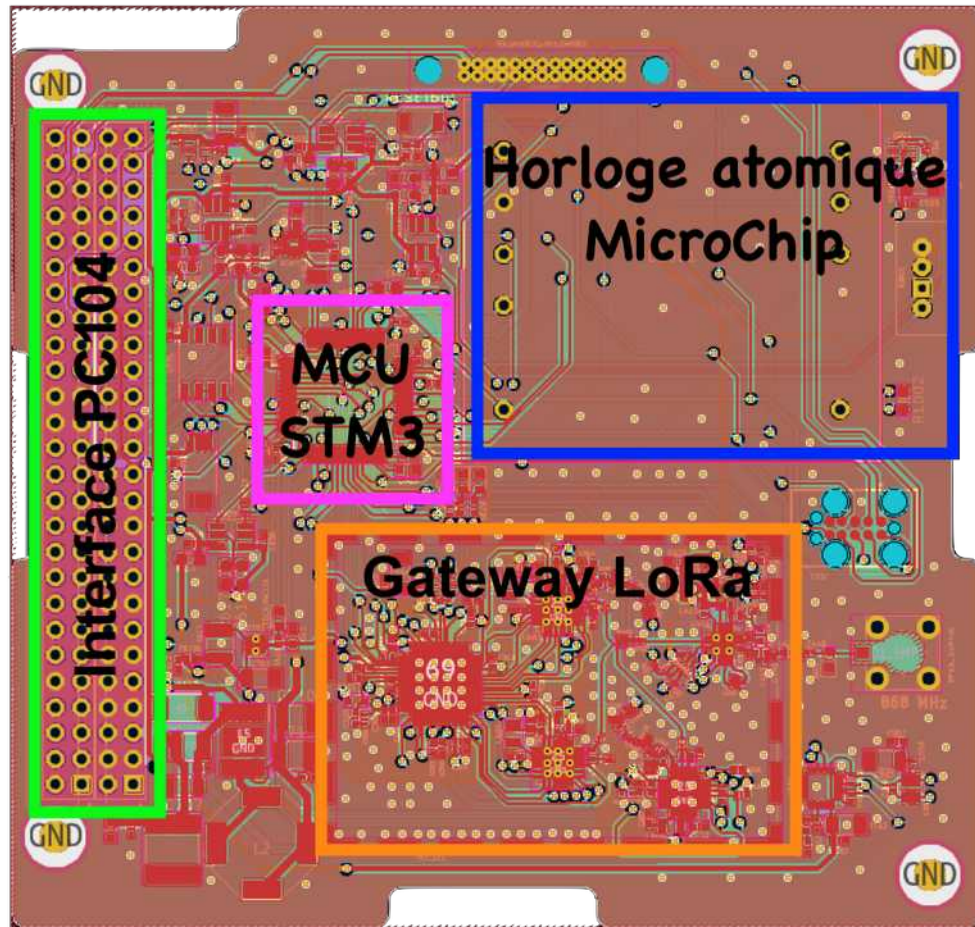



<https://gricad-gitlab.univ-grenoble-alpes.fr/thingsat>



# Thingsat Partners



GORGY TIME