

# MEASUREMENT OF STRAY LIGHT IN THE LISA INSTRUMENT

MARCO NARDELLO, AMAËL ROUBEAU-TISSOT, MICHEL LINTZ  
CNRS ARTEMIS, OBSERVATOIRE DE LA CÔTE D'AZUR



# LISA mission

2/24

- ▶ Laser Interferometer Space Antenna
- ▶ ESA-NASA mission for detection of gravitational waves
- ▶ Launch in 2035
- ▶ 3 spacecraft, 2.5 million km triangular formation, solar orbit
- ▶ Separation of free-floating reference surfaces in each satellite is measured using laser interferometry
- ▶ Distance variations (tens of pm) caused by a passing gravitational wave are measured
- ▶ Science objectives:
  - ▶ Study the formation and evolution of compact binary stars
  - ▶ Trace the origin, growth and merger of massive black holes

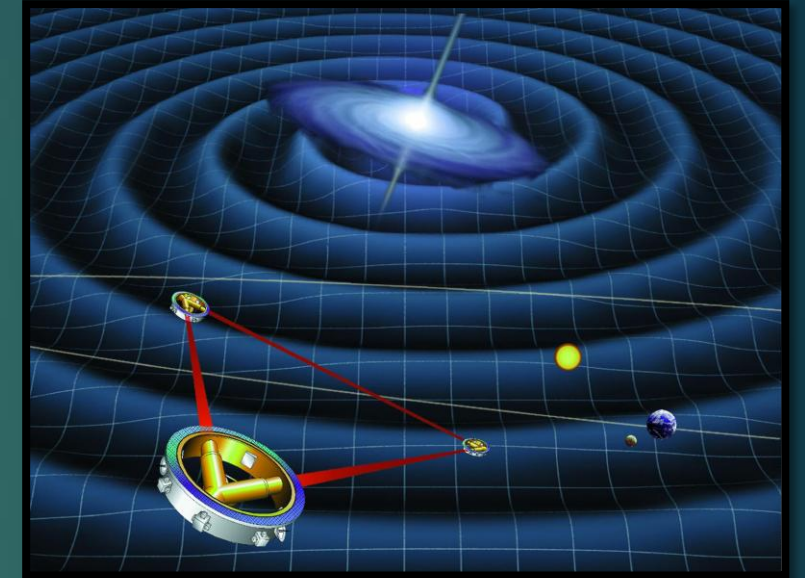

# LISA instrument

3/24

On each spacecraft:

- 2 telescopes
  - ▶ expand the generated beam and direct it towards the distant spacecraft
  - ▶ collects the beam coming from the distant spacecraft
- 2 optical benches carrying each:
  - ▶ 1 laser beam directed towards another spacecraft to measure SC-SC displacements
  - ▶ 1 laser beam coming from a distant spacecraft
  - ▶ 1 reference laser to measure SC-test mass displacements
  - ▶ several optical elements
  - ▶ 2 science interferometers, 2 reference interferometers, 2 test mass interferometers

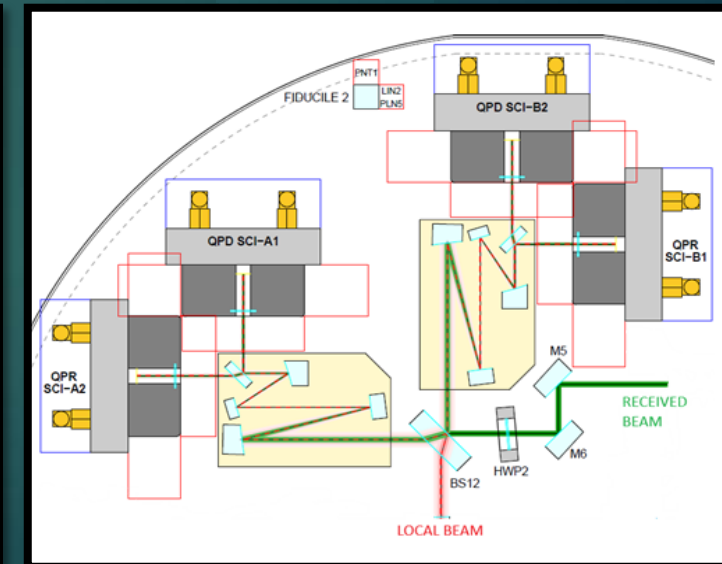
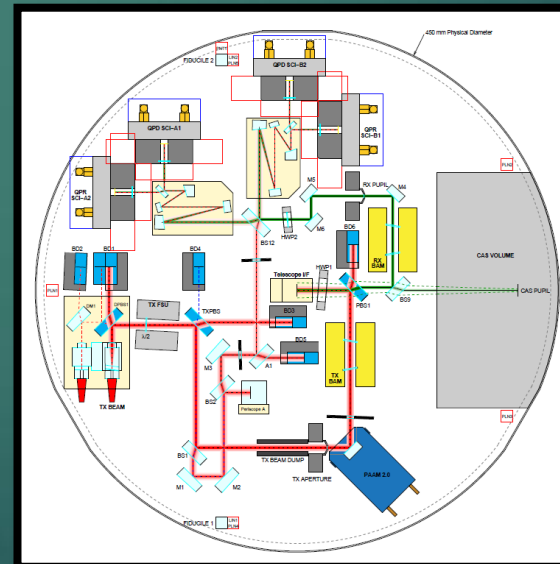
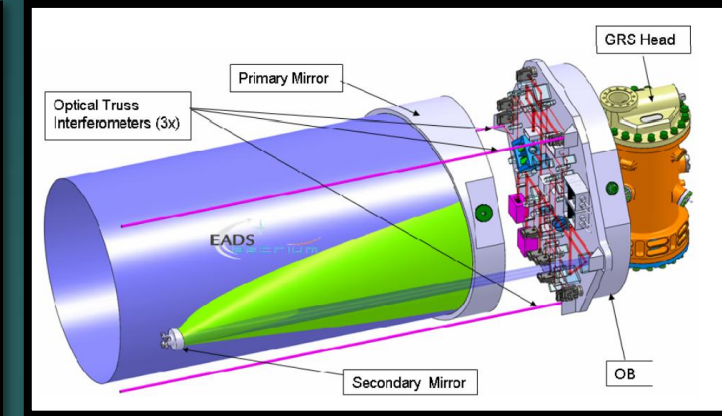
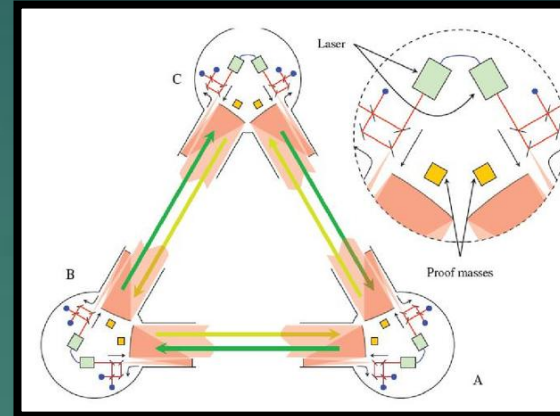

# Stray light in LISA

4/24

- ▶ Stray light influences the interferometric measurement
- ▶ Light superposed to nominal with different phase on detector
- ▶ Detected phase shifted by

$$\Delta\psi_{Het} = \varepsilon_{SL} \sin\left(\frac{2\pi}{\lambda} \Delta L\right)$$

- ▶  $\varepsilon_{SL}$  = stray light amplitude ratio
- ▶  $\Delta L$  = optical pathlength difference (OPD)

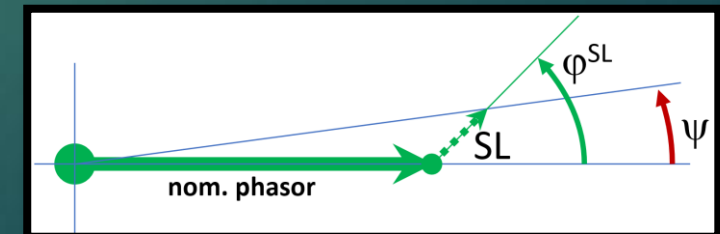
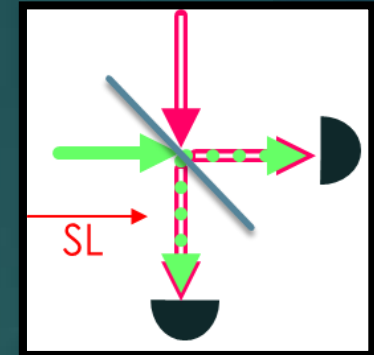

# SL measurement at system level: method

5/24

## SL-OGSE instrument

- ▶ Aim: To determine the presence, amplitude and OPD of coherent stray light in a complex optical system
- ▶ FMCW (Frequency Modulated Continuous Wave) method : laser swept in frequency
- ▶ Test all injectors one by one
- ▶ Data collected from every photoreceivers: photoreceivers of the system and added photodiodes
  - ▶ Signals recorded while frequency is scanned
  - ▶ Fourier transform → frequency spectra

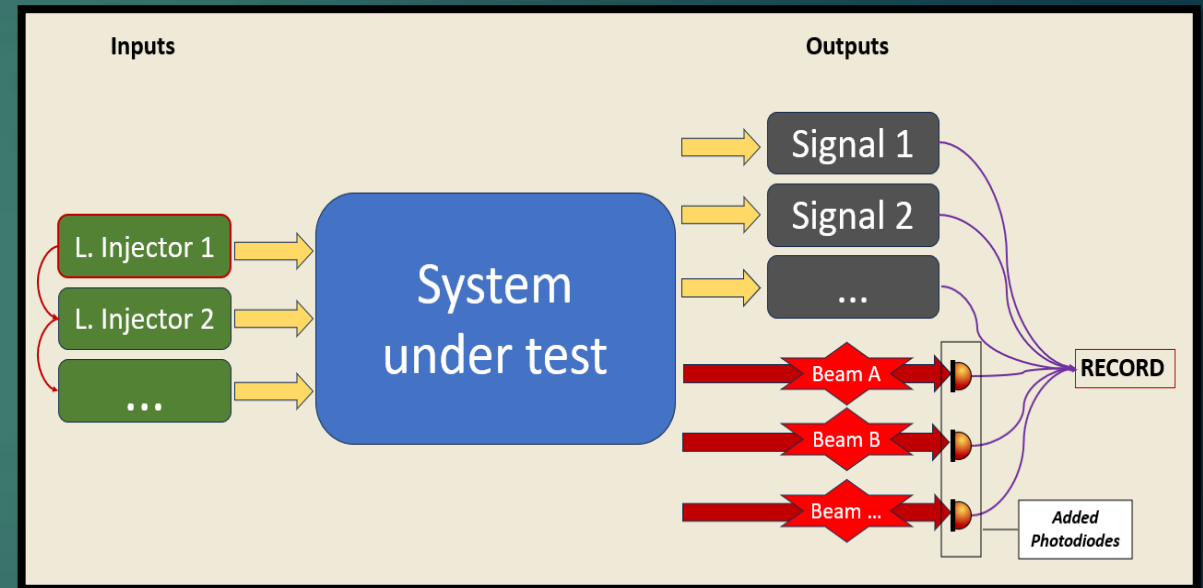

# Measurement principle

6/24

- ▶ Stray light gives interference fringes in the spectra:

$$f_{itf} = \frac{\Delta L}{c} \frac{\Delta \nu_{opt}}{\Delta t}$$

- $\Delta L$  = SL to nominal OPD
- $\Delta \nu_{opt}$  = SL\_ OGSE laser frequency scan rate
- Resolution required for instrumentation:  $\Delta(\Delta L) < 2mm$
- Noise floor for the measurement of the fractional signal amplitude  
 $SL/nom = 2\varepsilon_{SL} < 2.2 \cdot 10^{-6}$

# SL-OGSE prototype scheme

7/24

- ▶ Frequency swept laser: 1064.5 nm laser diode swept over 2 nm (30°C)
- ▶ Injection on DUT
- ▶ Frequency ramp monitoring (calibrator): check the quality of the ramp with a stable fibered IFO
- ▶ Frequency scan rate measurement: beat note with a fixed frequency laser
- ▶ Control of the frequency ramp: Phase lock during the scan using a MZ heterodyne IFO

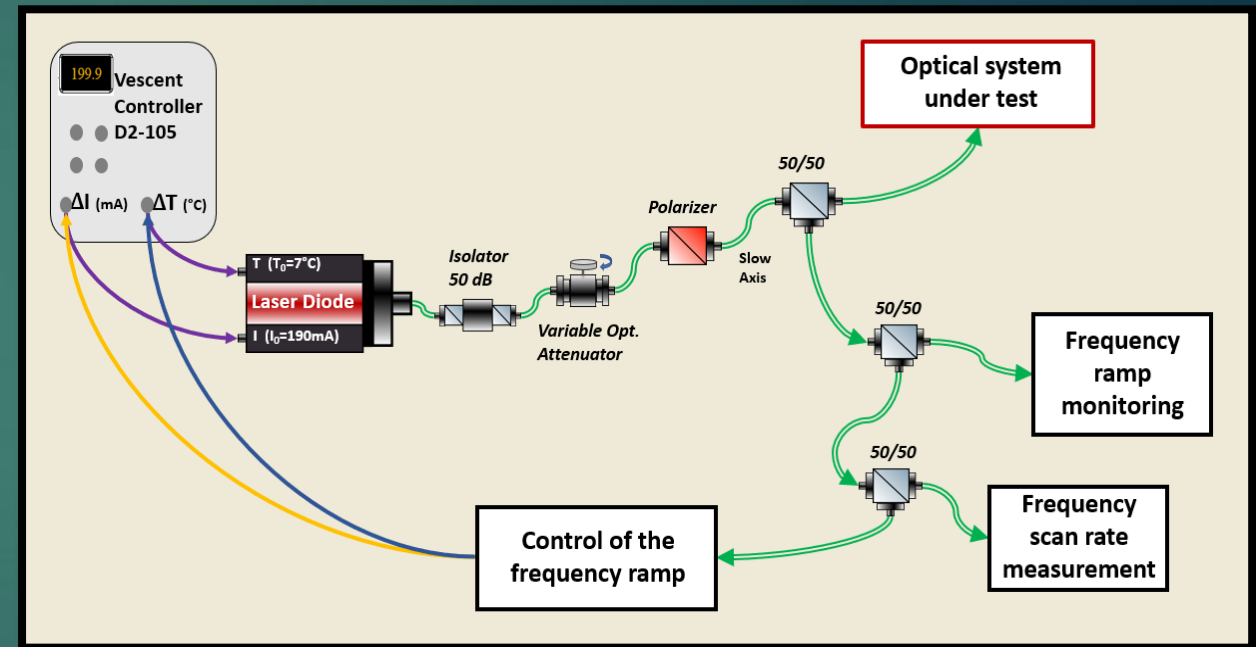

# Measurement example: calibrator signal

8/24

- ▶ Calibrator principle same as any DUT
  - ▶ Fibered interferometer
  - ▶ “Nominal” light goes directly to detector
  - ▶ “SL” arrives at the detector after  $n$  loops
  - ▶ Each loop corresponds to 1 SL peak on the plot
- ▶ 2 different frequency scans
  - ▶ Conversion  $f$ /OPD
  - ▶ SL peaks superposed
  - ▶ Not superposed peaks are parasites (electric grid)

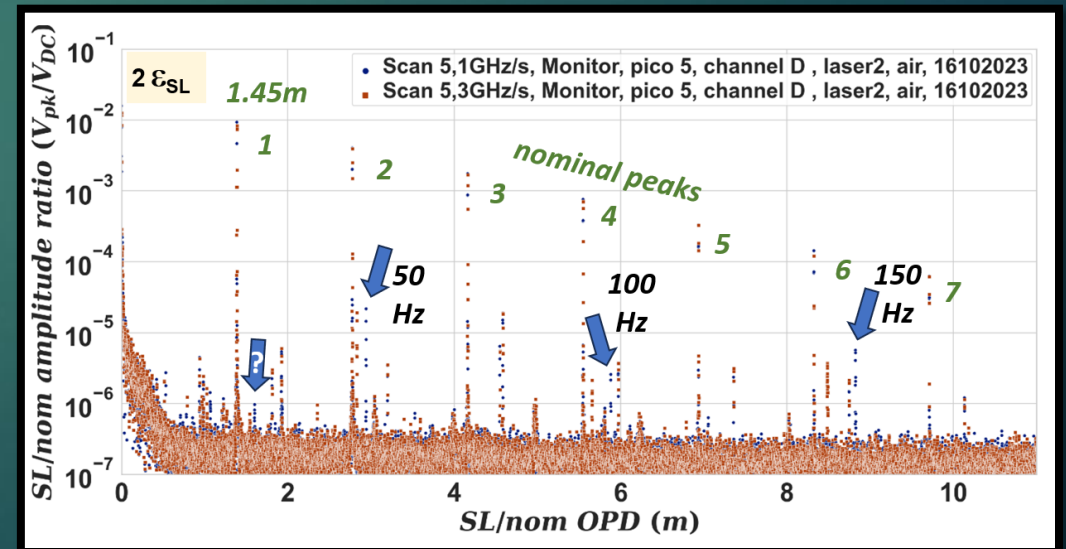
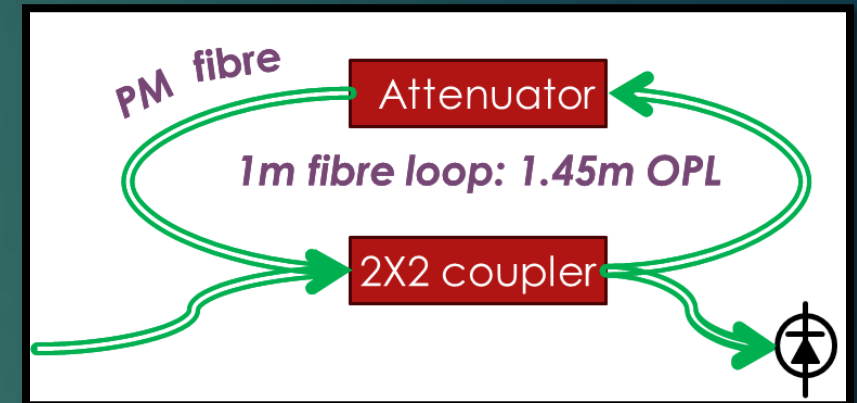



# Zerodur InterFerOimeters (ZIFO)

9/24

- ▶ Check phase measurement stability in a system as complex as the MOSA
- ▶ 3 heterodyne interferometers
- ▶ 36 signals: 8 QPRs (ABCD segments), 4 SEPRs
- ▶ 2 main injectors (beam 1 and 2)

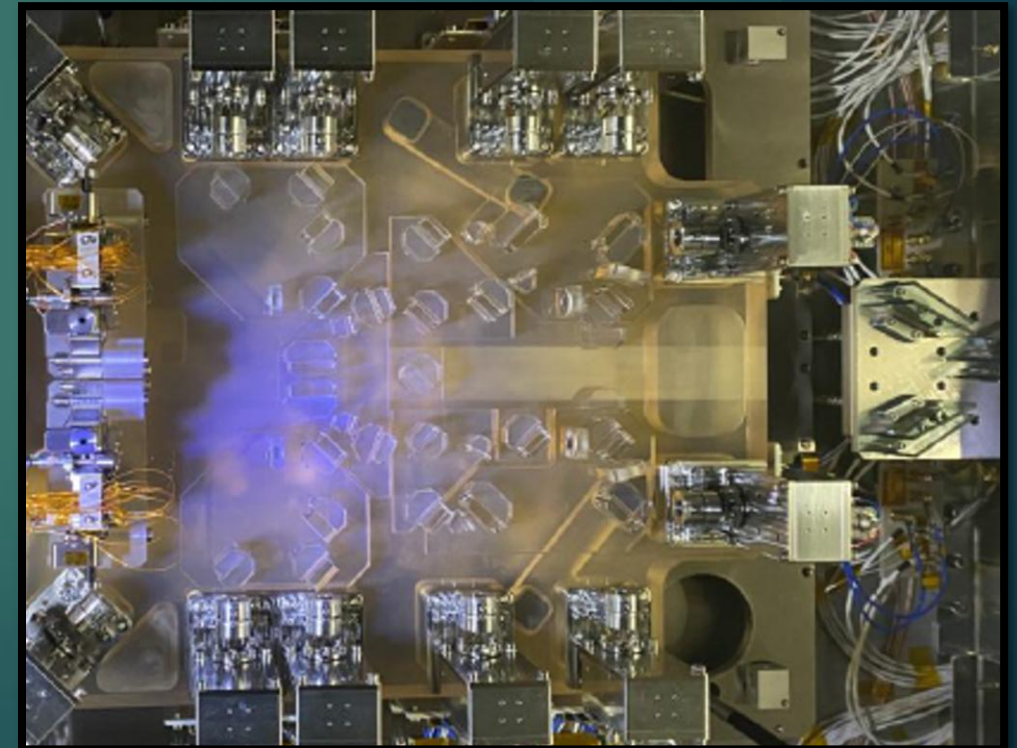
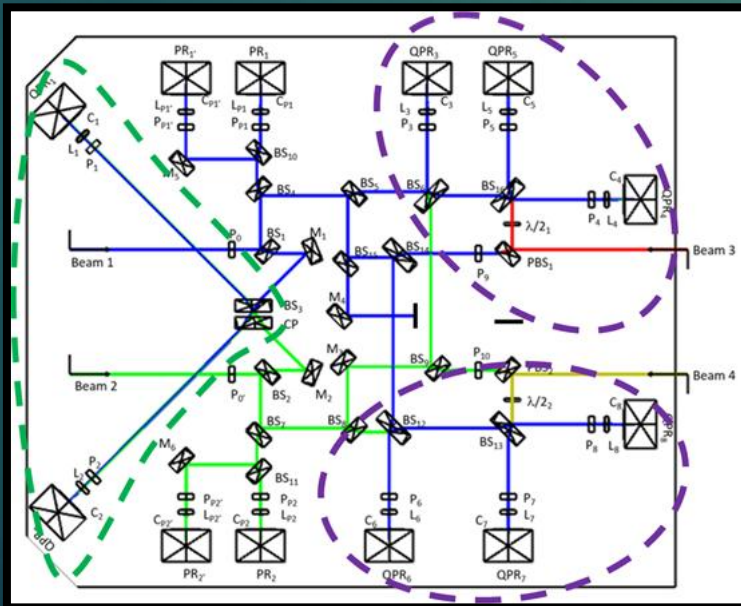

# SL recordings with ZIFO

10/24

- ▶ SL-OGSE laser injected at the 2 injectors alternatively
- ▶ Air and under vacuum
- ▶ 2 scan rates (5.1 and 5.3GHz/s)
- ▶ 2nm frequency range (around 1064.5 nm)
- ▶ Scan duration 100 s

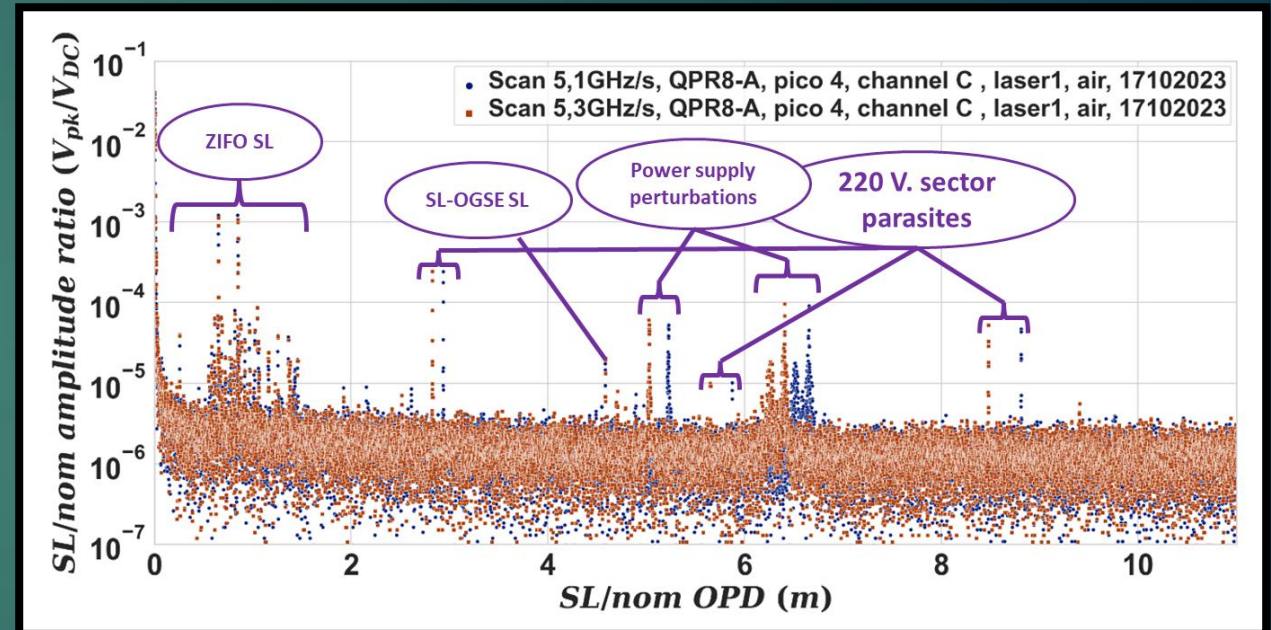

# Results interpretation

11/24

- ▶ Measured OPDs need to be linked to SL paths
  - ▶ Where is SL originated
  - ▶ Which directions it takes
  - ▶ How can we stop it?
- ▶ Simulations needed to calculate those paths

# Optical simulations

12/24

- ▶ Ray tracing simulations (FRED)
- ▶ On ZIFO optomechanical setup
  - ▶ Source: 50x50 rays on a grid with gaussian power profile
  - ▶ Laser injection at injector 1
  - ▶ Mechanics: absorbing
  - ▶ Side surfaces: blocking path
  - ▶ Nominal paths: Red and green. SL: blue
  - ▶ **QPR2 not tilted**

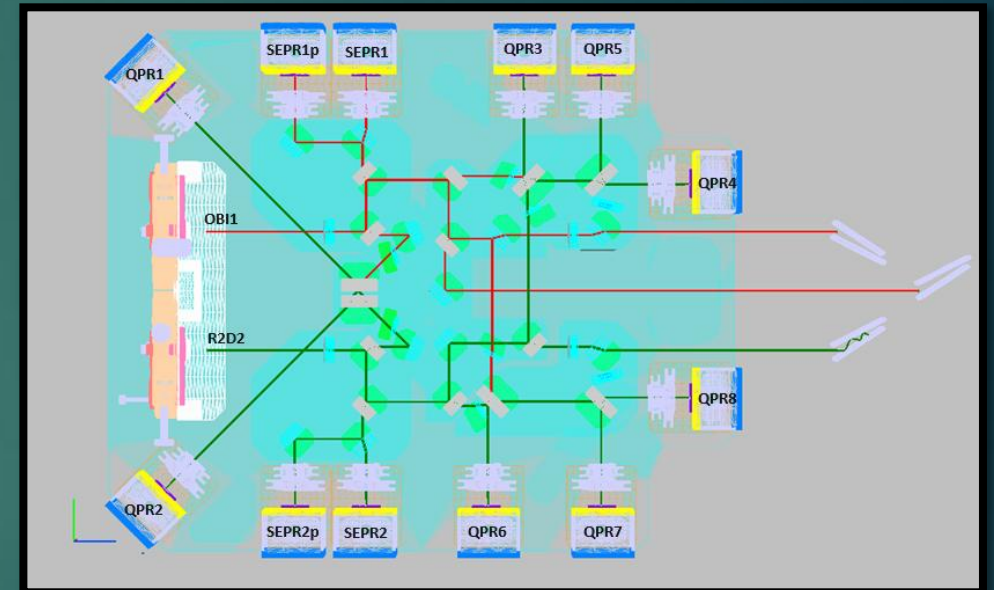

# Simulation results

- ▶ Simulation output (automatic script)
  - ▶ For each detector, a table with (#, P, OPL, OPD, # of rays, # of interactions)
- ▶ Optical path images

	A	B	C	D	E	F
1	Path #	P (W)	OPL	OPD	# of rays	# of interactions
2	19	8.8808E-05	499.704108	0	1876	15
3	1501	3.581E-10	501.210693	1.506585	1876	17
4	1510	3.581E-10	501.210693	1.506585	1876	17
5	3548	3.8988E-12	508.693684	8.98957577	190	17
6	3791	5.0719E-14	1348.60168	848.89757	38	51
7	3834	1.0636E-14	1356.2141	856.509994	36	51
8	15986	5.0618E-14	1348.60168	848.89757	38	53
9	15987	5.0719E-14	1348.60168	848.89757	38	51
10	15988	5.0821E-14	1348.60168	848.89757	38	49
11	16068	1.0615E-14	1356.2141	856.509994	36	53
12	16080	1.0636E-14	1356.2141	856.509994	36	51
13	16092	1.0658E-14	1356.2141	856.509994	36	49
14	29493	1.1143E-08	1347.09483	847.390725	36	49
15	30456	4.4571E-14	1348.60142	848.897309	36	51
16	30457	2.233E-11	1310.10273	810.39862	40	47
17	30458	2.2285E-11	1339.09504	839.390933	37	49
18	30459	1.112E-08	1347.09483	847.390725	36	51
19	30461	1.1143E-08	1347.09483	847.390725	36	49
20	30464	3.5066E-14	1287.48322	787.779116	36	41
21	30466	2.2375E-11	1318.10234	818.398235	39	45
22	30470	1.1165E-08	1347.09483	847.390725	36	47
23	30479	4.4571E-14	1348.60142	848.897309	36	51
24	30489	5.5602E-12	1376.0874	876.383291	35	53
25	30494	5.5713E-12	1376.0874	876.383291	35	51
26	30497	5.5713E-12	1355.09484	855.390727	35	51
27	30498	5.5825E-12	1355.09484	855.390727	35	49
28	30499	1.1143E-14	1376.0874	876.383291	35	51
29	30500	5.5602E-12	1384.08732	884.383213	35	53
30	30501	5.5713E-12	1384.08732	884.383213	35	51
31	35704	4.4482E-14	1348.60142	848.897309	36	53

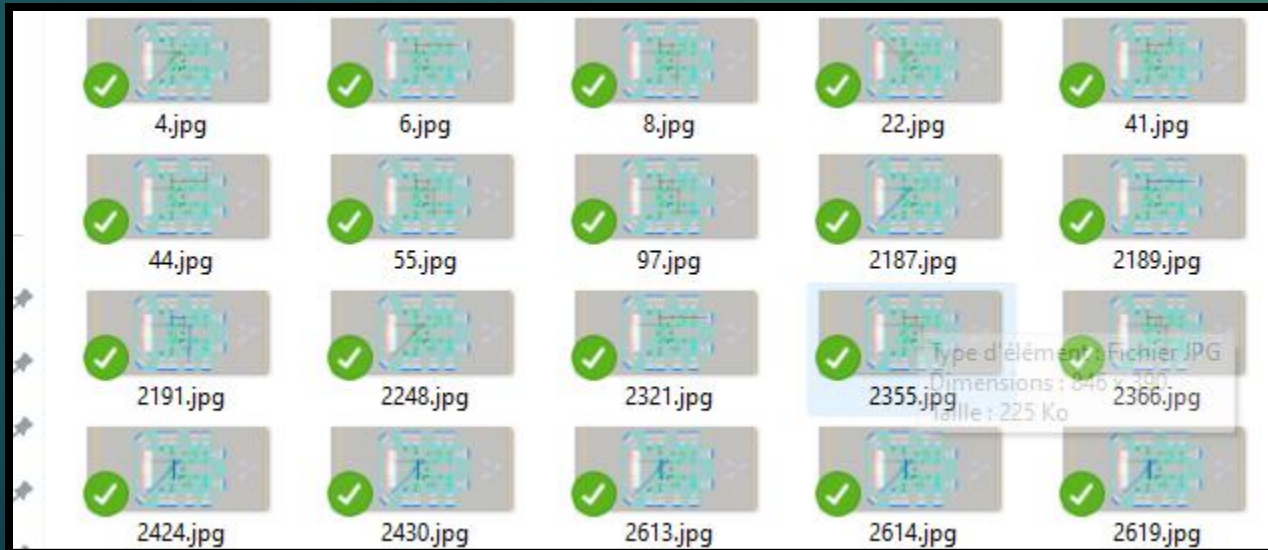

# Comparison with measurements

14/24

- ▶ Measurement results
  - ▶ On air, injector 1, 5.1 GHz/s
  - ▶ Post-treatment analysis gives list of peaks (OPD, amplitudes) for each detector  $> 10^{-5}$
- ▶ On the same plot
  - ▶ Measured peaks positions (orange circles)
  - ▶ Simulated peaks positions (blue triangles)
- ▶ Amplitudes
  - ▶ Qualitatively they match
  - ▶ No exact match (no exact simulation parameters)
- ▶ OPDs?

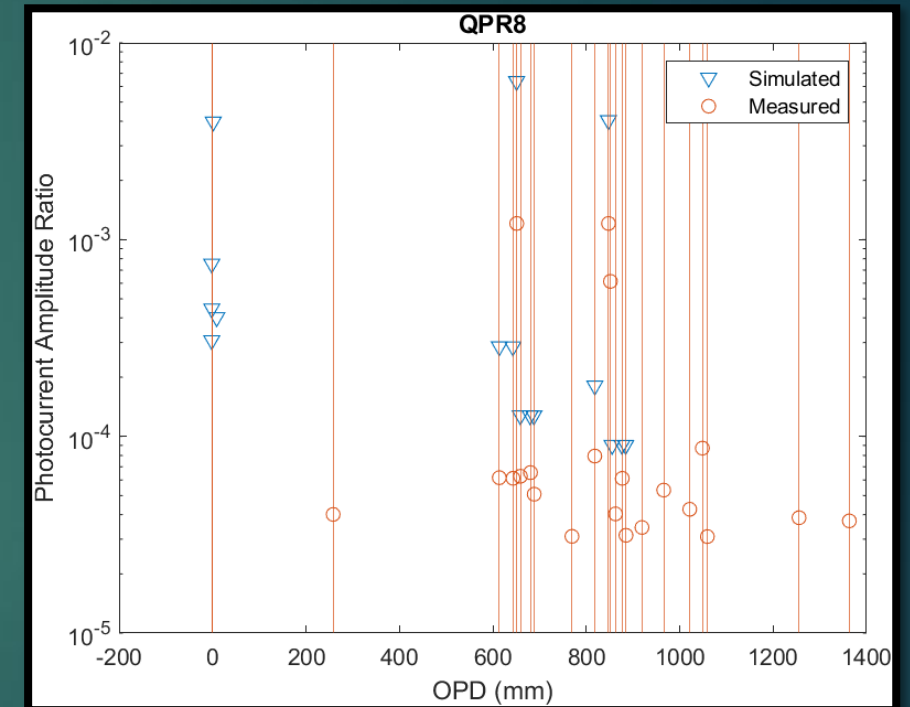

# Good matches

15/24

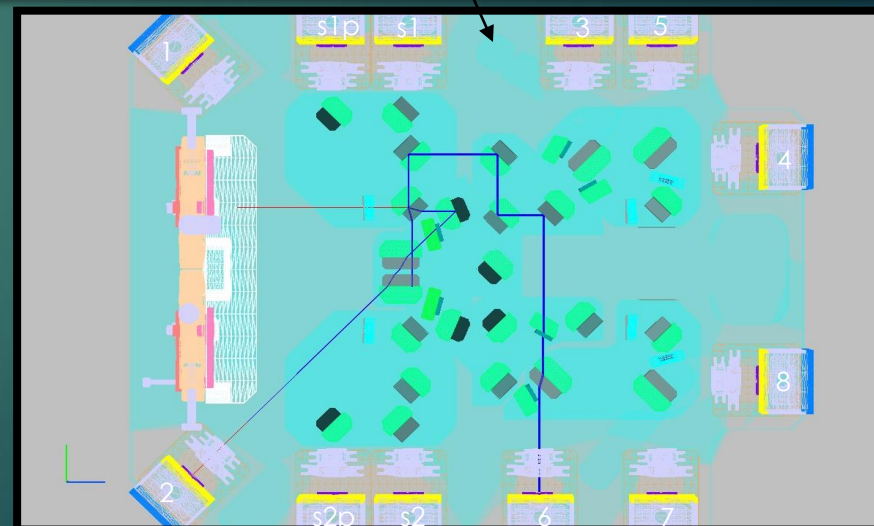
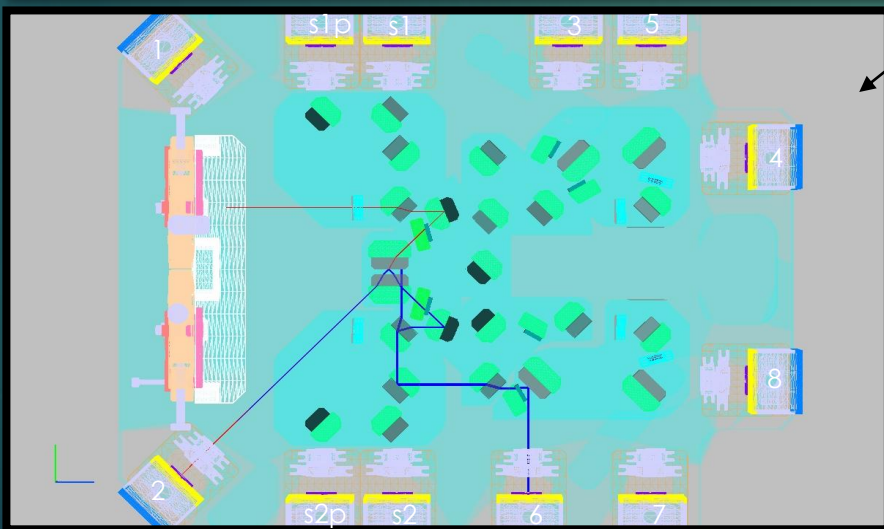
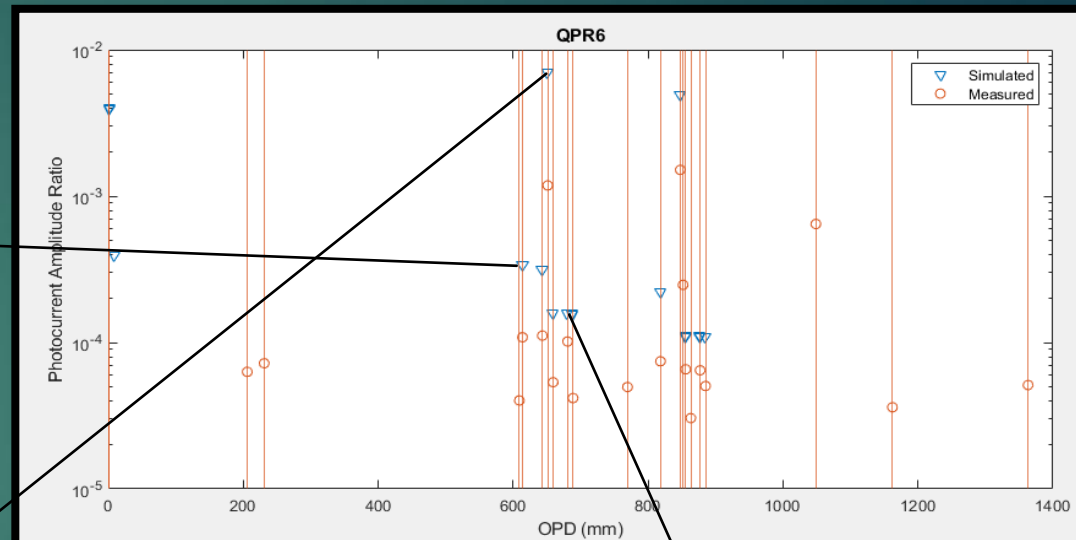
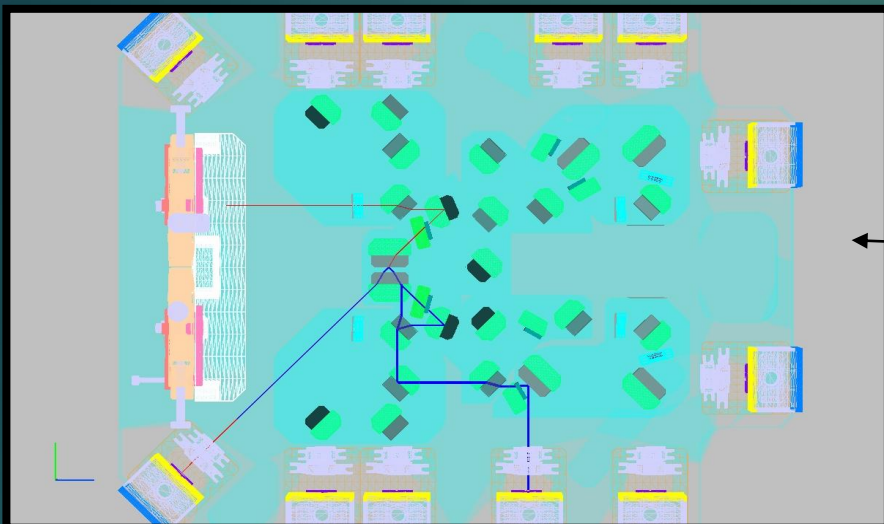

# Simulations not matching

16/24

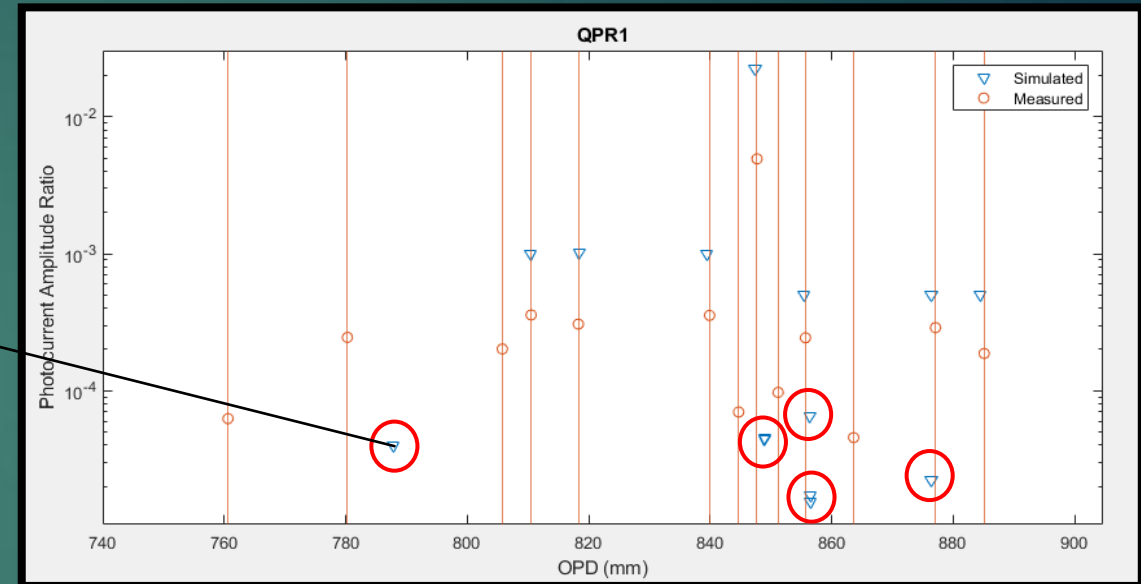
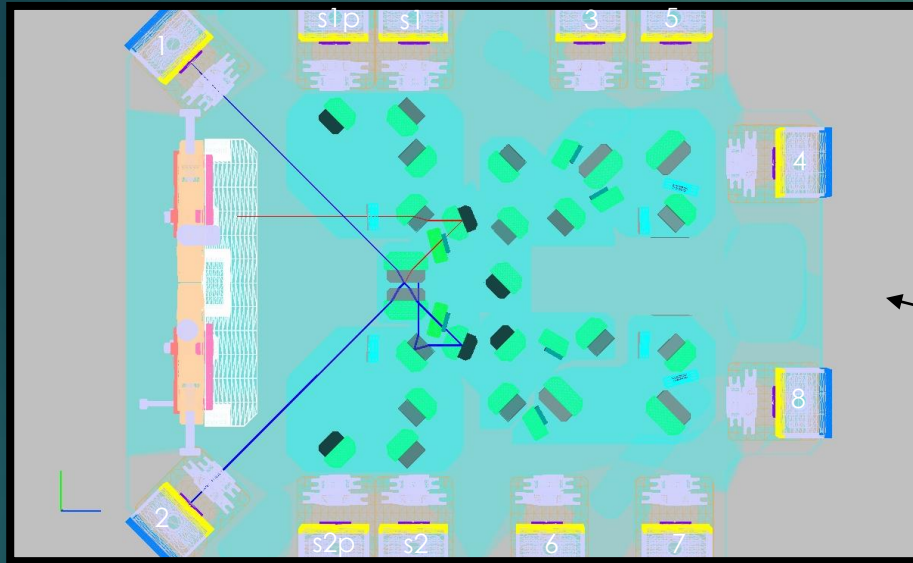

- ▶ Only because of thresholding
  - ▶ Low amplitudes on measurements covered by noise and/or discarded



# Measurements not matching

17/24

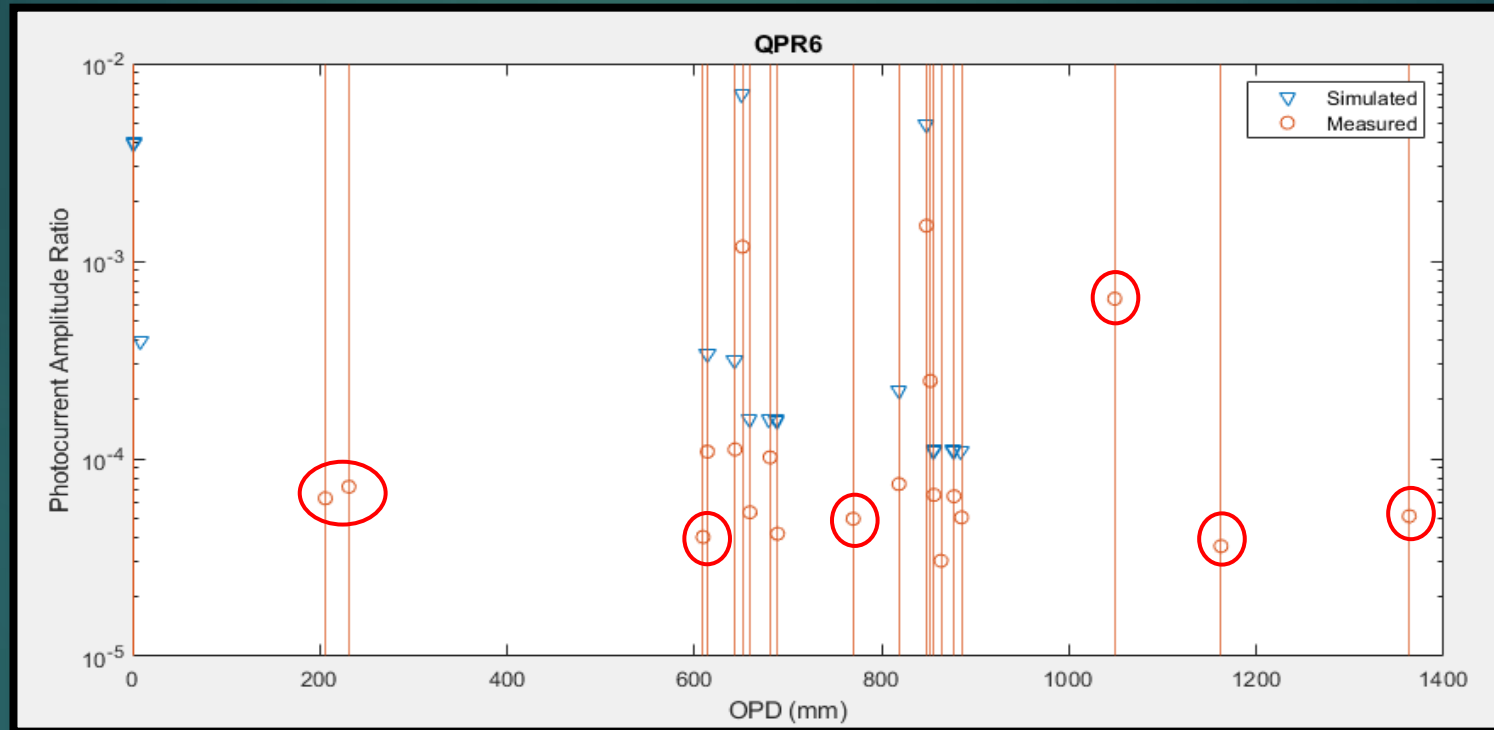

- ▶ Simulation parameters re-evaluation
  - ▶ Some parameter are difficult to estimate
  - ▶ There is a deviation from the nominal setup

# New parameters

18/24

- ▶ Reflection on mechanical elements
- ▶ Sides of beam splitters transparent
- ▶ Reflection on the thermal shield
- ▶ Reflection on lenses
- ▶ Reflection on not tilted components

# BS sides

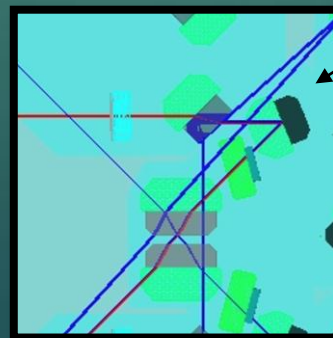
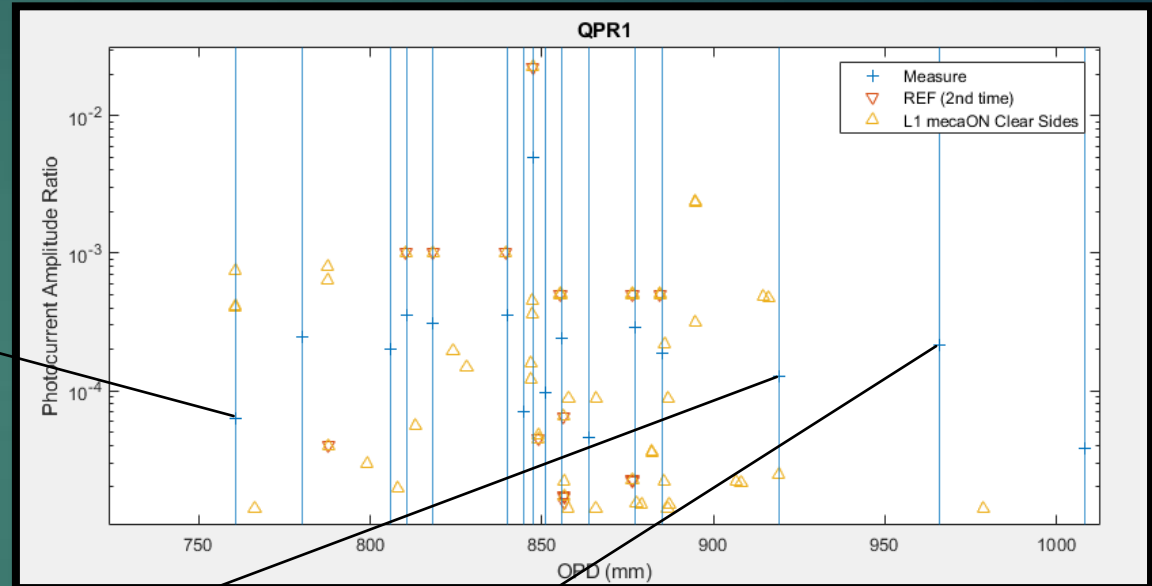
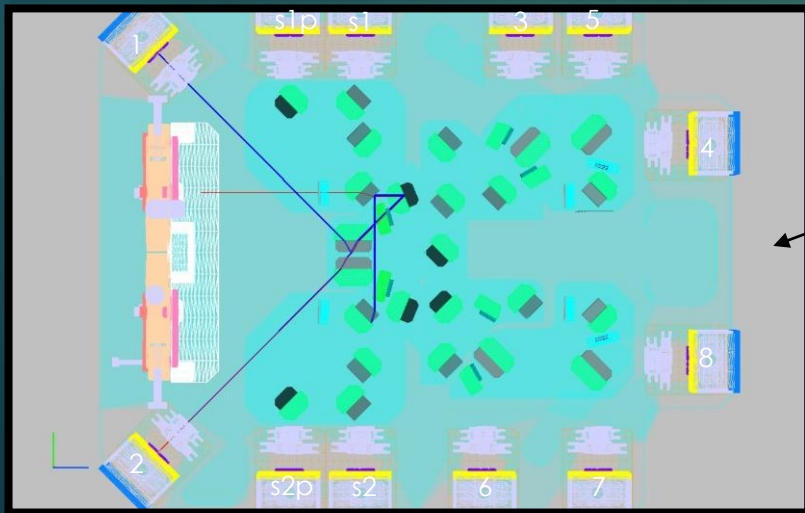
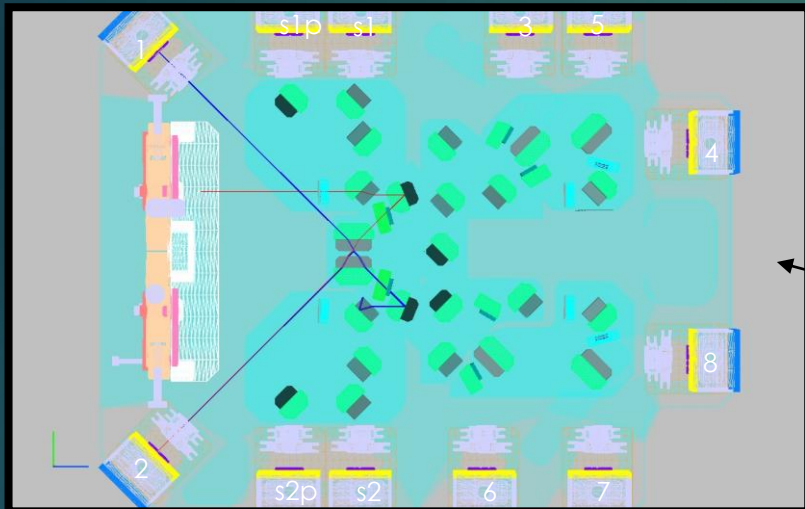

- ▶ Some peaks explained
- ▶ Many unrealistic paths created

# Detector 7 not tilted

20/24

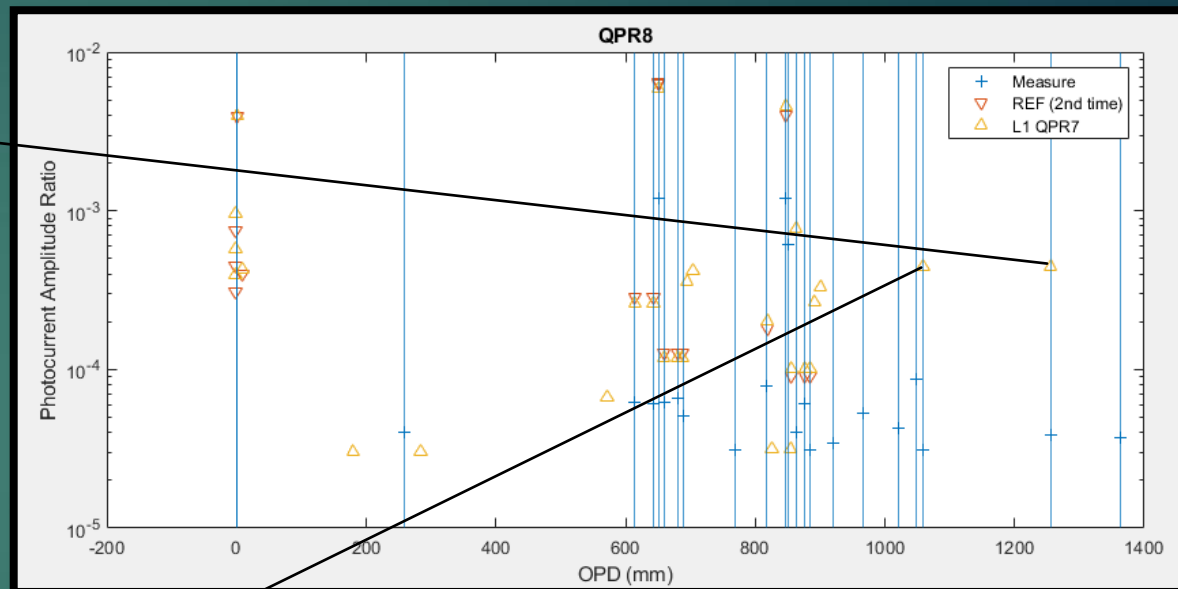
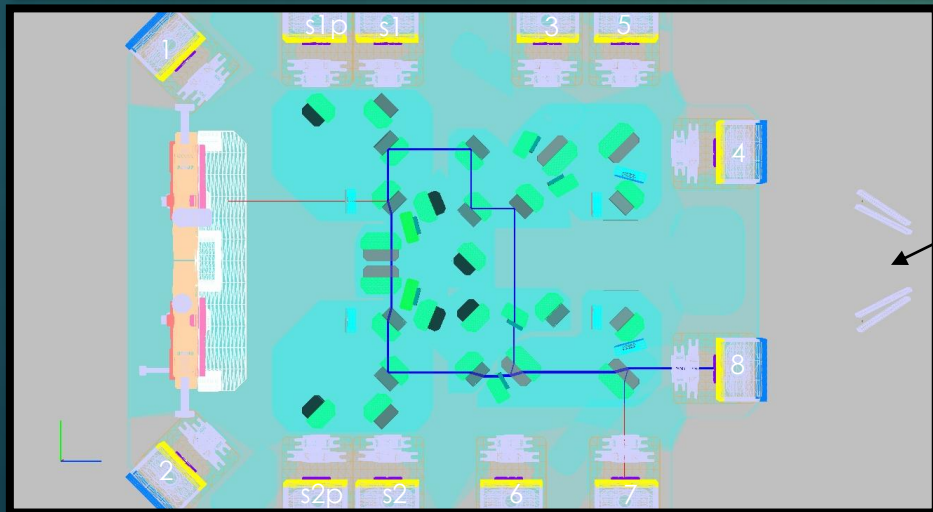
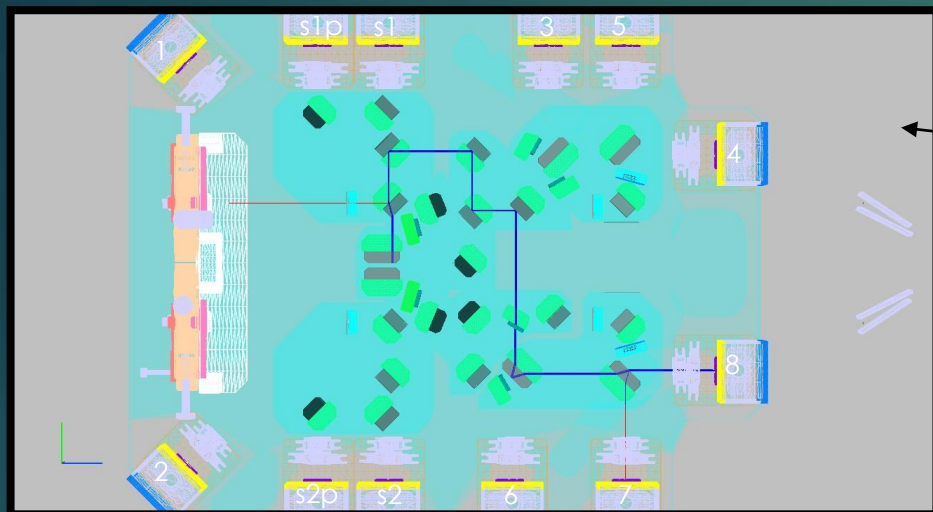

- ▶ Some peaks explained
- ▶ Absence of tilt verified experimentally

# Lenses

21/24

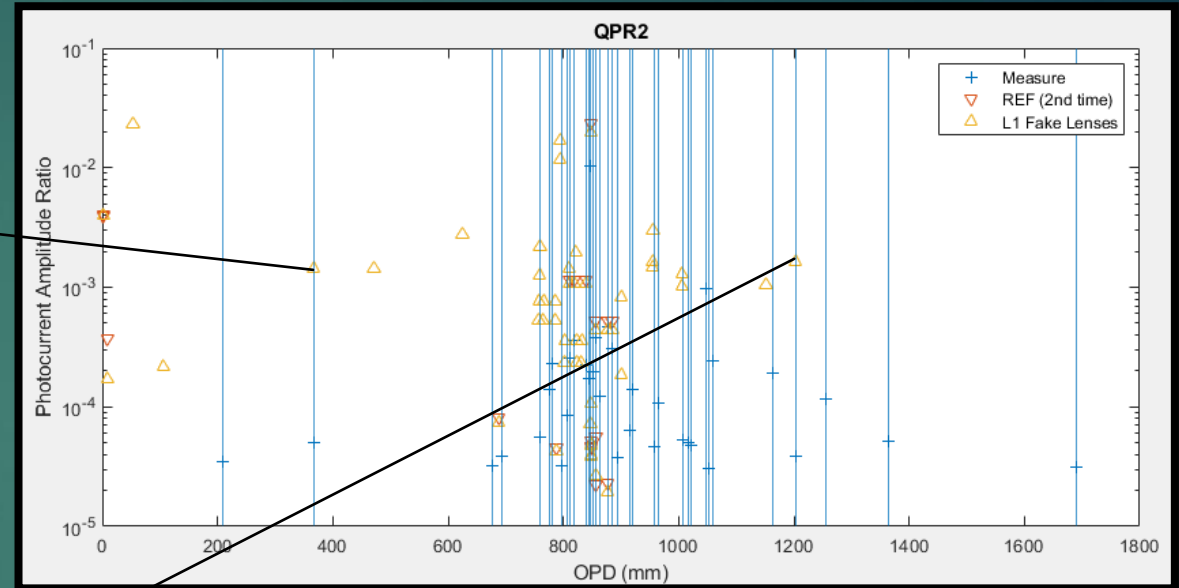
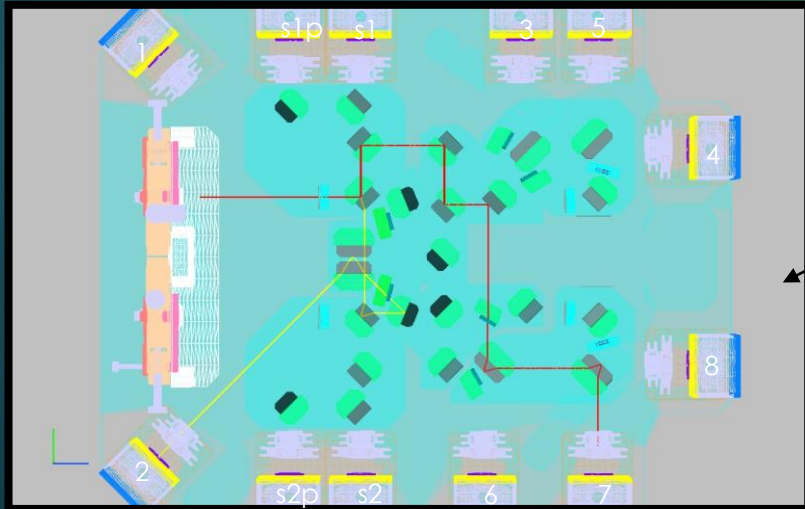
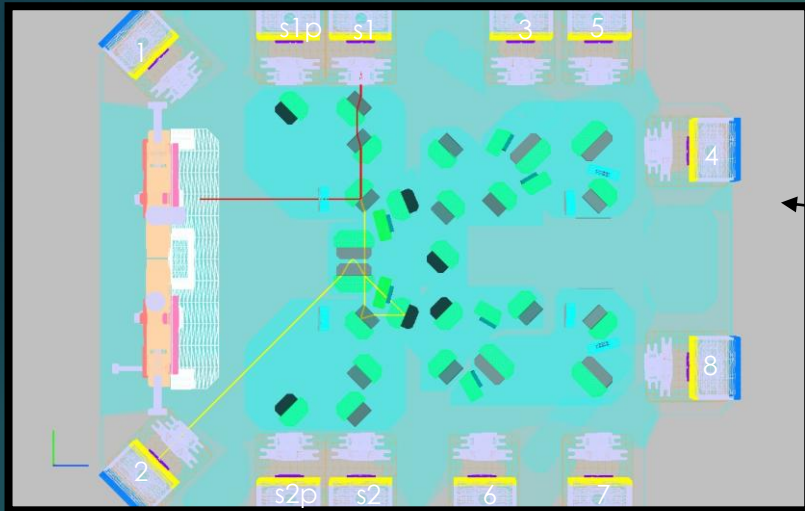

- ▶ Difficult to simulate lens curvature with a discrete number of rays
- ▶ Fake plane added to simulation
  - ▶ Some peaks explained
  - ▶ Not existent path created

# Not tilted polarizers

22/24

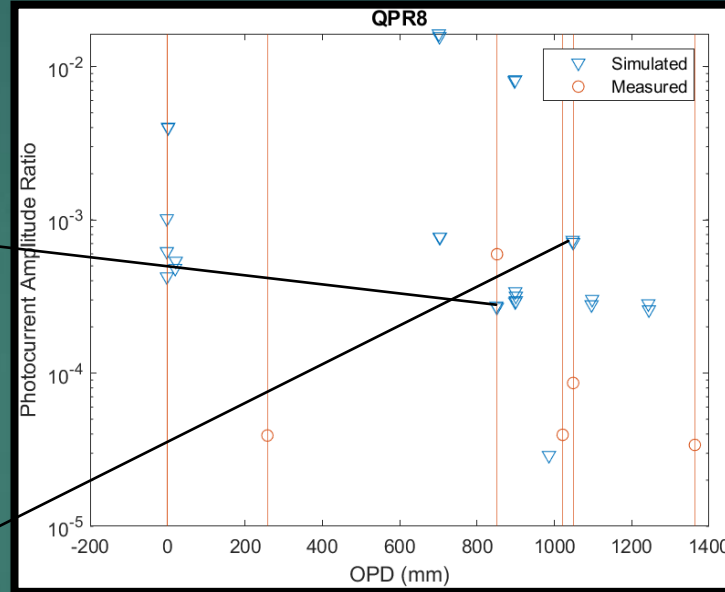
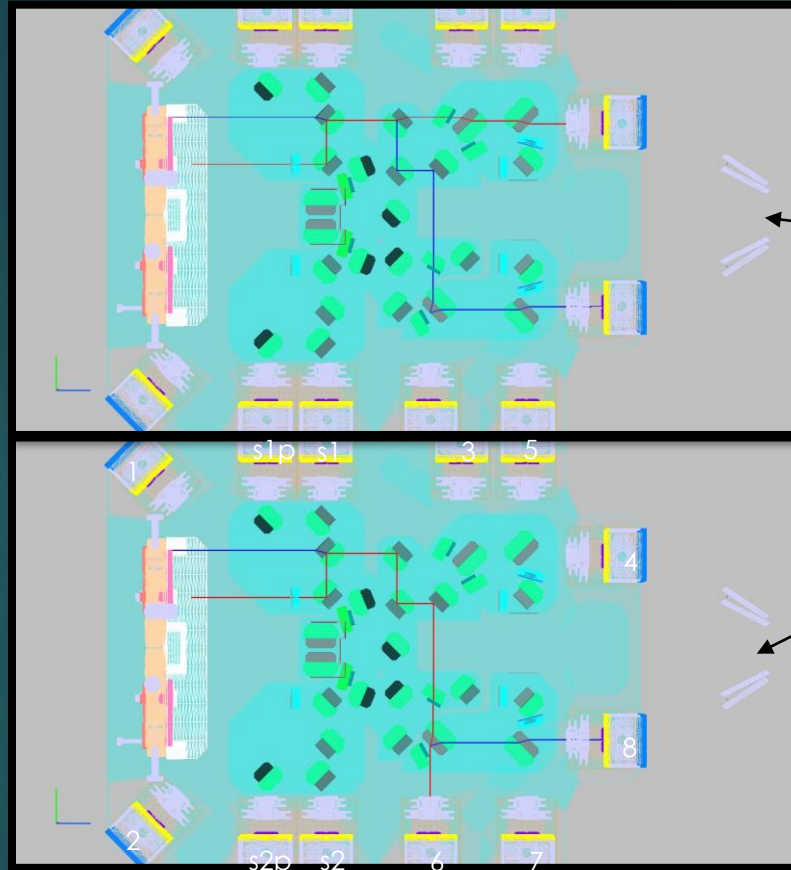

- ▶ Peaks explained
- ▶ Why should the polarizers not be tilted?
- ▶ Coincidence?

# Overall results

23/24

Peaks	QPR1	QPR2	QPR3	QPR4	QPR5	QPR6	QPR7	QPR8
<b>Measured</b>	<b>23</b>	<b>35</b>	<b>20</b>	<b>20</b>	<b>21</b>	<b>20</b>	<b>19</b>	<b>21</b>
Starting (nominal) parameters	7	7	10	9	9	11	10	10
<i>% match</i>	30	20	50	45	43	55	53	48
Final parameters	10	19	14	13	13	15	15	18
<i>% match</i>	43	54	70	65	62	75	79	86

# Conclusions

- ▶ The SL-OGSE instrument is an effective tools to measure SL at system level
- ▶ Data interpretation relies on ray tracing simulations
- ▶ Simulations give a good view of the nominal setup
- ▶ Deviation from nominal can be investigated
  - ▶ Parameter choice must be made with caution
  - ▶ Experimental verification advisable
  - ▶ 100% explanation not guaranteed



Extra slides

# Control of the frequency ramp

- ▶ Beatnote in the MZ interf. (freq F)
- ▶ Phase lock control of frequency
- ▶ Sweep: 25m delay moves the beatnote at  $F+\Delta F$
- ▶ Phase lock to keep  $F+\Delta F = \text{const}$

→  
Constant ramp

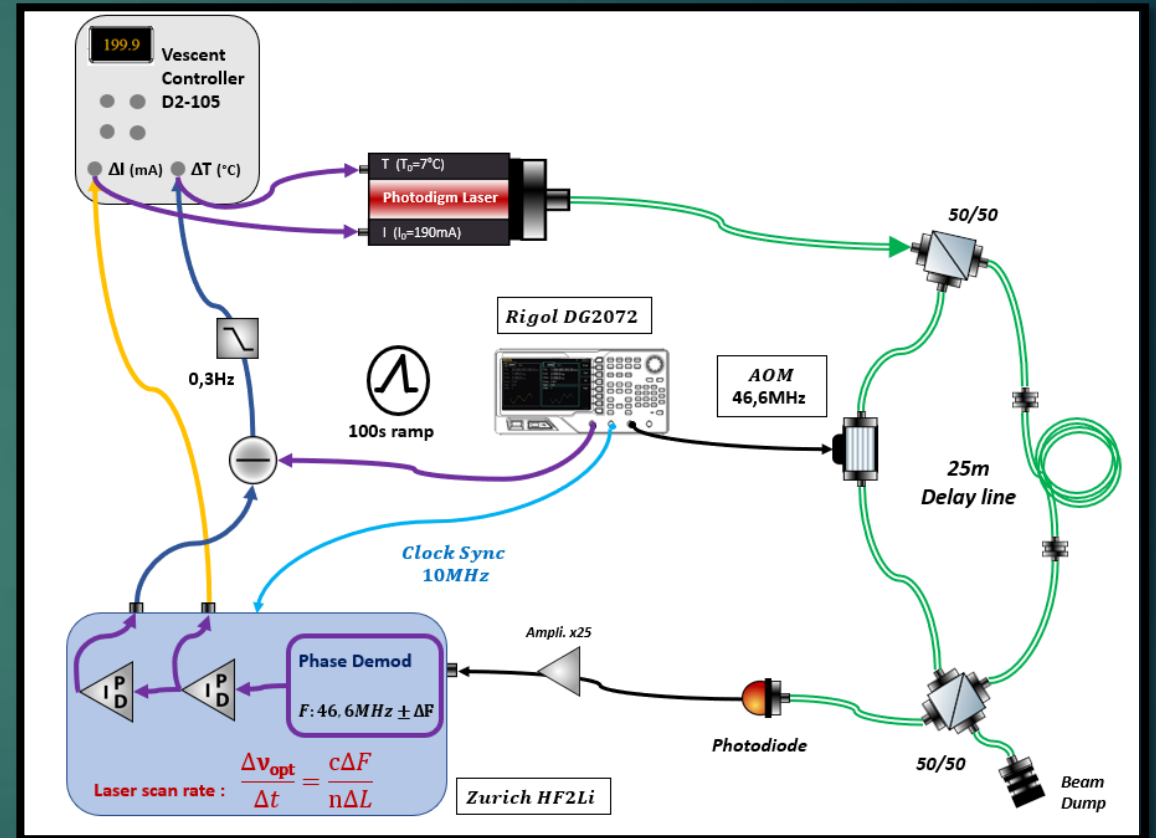

# Frequency measurement

- ▶ Interference with a fixed frequency laser
- ▶ Beatnote frequency measured

