



HAL
open science

MUSE Field Splitter Unit: Fan-shaped Separator for 24 Integral Field Units

Florence Laurent, Edgard Renault, Heiko Anwand, Didier Boudon, Patrick Caillier, Johan Kosmalski, Magali Loupias, Harald Nicklas, Walter Seifert, Yves Salaun, et al.

► To cite this version:

Florence Laurent, Edgard Renault, Heiko Anwand, Didier Boudon, Patrick Caillier, et al.. MUSE Field Splitter Unit: Fan-shaped Separator for 24 Integral Field Units. SPIE Astronomical Telescopes + Instrumentation, Jun 2014, Montréal, France. pp.91511U, 10.1117/12.2057088 . hal-04785490

HAL Id: hal-04785490

<https://hal.science/hal-04785490v1>

Submitted on 15 Nov 2024

HAL is a multi-disciplinary open access archive for the deposit and dissemination of scientific research documents, whether they are published or not. The documents may come from teaching and research institutions in France or abroad, or from public or private research centers.

L'archive ouverte pluridisciplinaire **HAL**, est destinée au dépôt et à la diffusion de documents scientifiques de niveau recherche, publiés ou non, émanant des établissements d'enseignement et de recherche français ou étrangers, des laboratoires publics ou privés.

MUSE Field Splitter Unit: Fan-shaped Separator for 24 Integral Field Units

Florence Laurent^{*a}, Edgard Renault^a, Heiko Anwand^b, Didier Boudon^a, Patrick Caillier^a, Johan Kosmalski^a, Magali Loupiau^a, Harald Nicklas^b, Walter Seifert^c, Yves Salaun^d, Wenli Xu^e

^aUniversité de Lyon, Lyon, F-69003, France; Université Lyon 1, Observatoire de Lyon, 9 avenue Charles André, Saint-Genis Laval, F-69230, France; CNRS, UMR 5574, Centre de Recherche Astrophysique de Lyon; Ecole Normale Supérieure de Lyon, Lyon, F-69007, France; ^bInstitut für Astrophysik, Georg-August-Universität, 37077 Göttingen, Germany; ^cZentrum für Astronomie, Landessternwarte, Königstuhl 45, 69117 Heidelberg, Germany; ^dWinlight Optics & Winlight System, 135 Rue Benjamin Franklin, ZA St Martin, 84120 Pertuis, France; ^eOptical System Engineering, Kirchenstr. 6, 74937 Spechbach, Germany

ABSTRACT

MUSE (Multi Unit Spectroscopic Explorer) is a second generation Very Large Telescope (VLT) integral field spectrograph developed for the European Southern Observatory (ESO). It combines a 1' x 1' field of view sampled at 0.2 arcsec for its Wide Field Mode (WFM) and a 7.5"x7.5" field of view for its Narrow Field Mode (NFM). Both modes will operate with the improved spatial resolution provided by GALACSI (Ground Atmospheric Layer Adaptive Optics for Spectroscopic Imaging), that will use the VLT deformable secondary mirror and 4 Laser Guide Stars (LGS) foreseen in 2015. MUSE operates in the visible wavelength range (0.465-0.93 μm). A consortium of seven institutes is currently commissioning MUSE in the Very Large Telescope for the Preliminary Acceptance in Chile, scheduled for September, 2014.

MUSE is composed of several subsystems which are under the responsibility of each institute. The Fore Optics derotates and anamorphoses the image at the focal plane. A Splitting and Relay Optics feed the 24 identical Integral Field Units (IFU), that are mounted within a large monolithic instrument mechanical structure. Each IFU incorporates an image slicer, a fully refractive spectrograph with VPH-grating and a detector system connected to a global vacuum and cryogenic system. During 2012 and 2013, all MUSE subsystems were integrated, aligned and tested to the P.I. institute at Lyon. After successful PAE in September 2013, MUSE instrument was shipped to the Very Large Telescope in Chile where it was aligned and tested in ESO integration hall at Paranal. After, MUSE was directly transferred in monolithic way onto VLT telescope where the first light was achieved.

This paper describes the MUSE main optical component: the Field Splitter Unit. It splits the VLT image into 24 subfields and provides the first separation of the beam for the 24 Integral Field Units. This talk depicts its manufacturing at Winlight Optics and its alignment into MUSE instrument. The success of the MUSE alignment is demonstrated by the excellent results obtained onto MUSE positioning, image quality and throughput onto the sky. MUSE commissioning at the VLT is planned for September, 2014.

Keywords: Field Splitter Unit, Optical alignment, VLT, MUSE instrument

1. INTRODUCTION

Built for the European Southern Observatory (ESO) for the second generation VLT instrumentation, MUSE (Multi Unit Spectrograph Explorer) is installed on the Very Large Telescope (VLT), Telescope Unit 4 (UT4), Nasmyth platform B for its first light the 7th of February, 2014. MUSE is an innovative IFS, named Integral Field Unit (IFU) in MUSE instrument, which combines a 1'x1' Field of View (FoV), with a spectral resolution reaching 3000 and a spatial sampling of 0.2'' matching the spatial resolution provided by a ground layer adaptive optics system named GALACSI. MUSE operates in a large visible spectral range (0.465 – 0.93 μm) with 2 functional modes a Wide Field Mode (WFM) and a Narrow Field Mode (NFM) where the latter has an eight times higher spatial resolution - [1].

*florence.laurent@univ-lyon1.fr; phone 33 4 78 86 85 33; fax 33 4 78 86 83 86; <http://cral.univ-lyon1.fr/>

The MUSE instrument is composed of a Calibration Unit, a Fore-Optics which includes an optical derotator and an anamorphoser by 2, a splitting optics cutting the FoV in 24 parts (topic of this paper) and 24 relay optics which feed 24 identical IFUs (Figure 1). Each IFU is composed of an original advanced image slicer associated with a high-throughput spectrograph with a Volume Phase Holographic Grating (VPHG) and a 4k×4k CCD detector.

This paper describes the manufacturing, alignment and tests of the Field Splitter Unit (FSU) with respect to MUSE references. The aims are to:

- Describe the Field Splitter Unit (requirements and references),
- Depict Field Splitter Unit manufacturing,
- Detail the tools used to perform the alignment,
- Define the alignment procedure and its internal results,
- Check this alignment directly onto MUSE instrument.

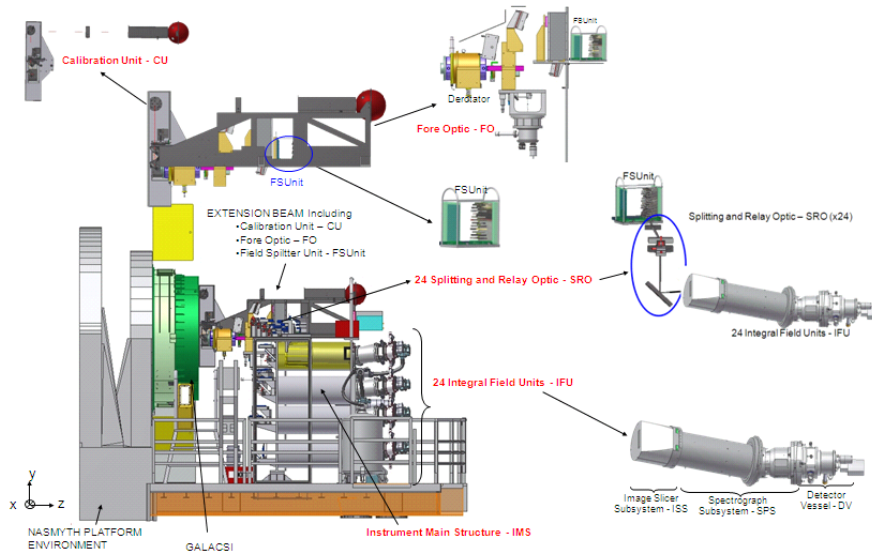

Figure 1: MUSE Mechanical Overview

2. SPLITTING AND RELAY OPTICS (SRO) DESCRIPTION

The Splitting and Relay Optics receive the light from the Fore-Optics, split the FoV in 24 sub-fields and guides the light from the individual sub-fields to the Integral Field Unit. The SRO consists of the Field Splitting (FS), the Field Separator (FSEP) and 24 Relay Optics (RO) to feed the spectrographs. To fulfil the requirements of a magnification of 1.51, on image quality and especially on telecentricity/quality of the re-imaged exit pupil of the output beam, an optical design with two doublets and for some paths one additional single lens has been developed. The RO has to cope with optical path length from 1489mm to 4155mm. This system is fulfilling all of the specifications.

The Field Splitter Unit as well as all the single lenses are located on top of the Instrument Main Structure (IMS) to make the layout compact. To optimize efficiency, a layout with only three beam foldings has been designed. The first fold mirror after the FSEP is redirecting the beams vertically; the second fold mirror is located just in front of the IFUs, redirecting the beam horizontally. Figure 2 gives a 3D optical layout of the SRO - a fan-like bridge with 24 channels.

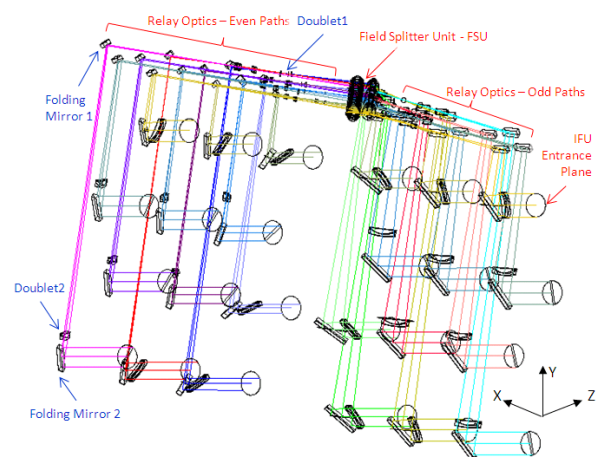

Figure 2: 3D optical layout of the SRO, light enters from FSU and split into 24 (2x12) channels to feed the 24 IFUs

3. FIELD SPLITTER UNIT DESCRIPTION

3.1 Optical Design [2]

The function of the FSU described here is to split the light coming from the fore-optic via a lens array into rectangular sub-fields and to separate them via a mirror array into different spatial directions. The Field Splitter Unit (FSU) is composed of the Field Splitting (FS) and the Field Separator (FSEP).

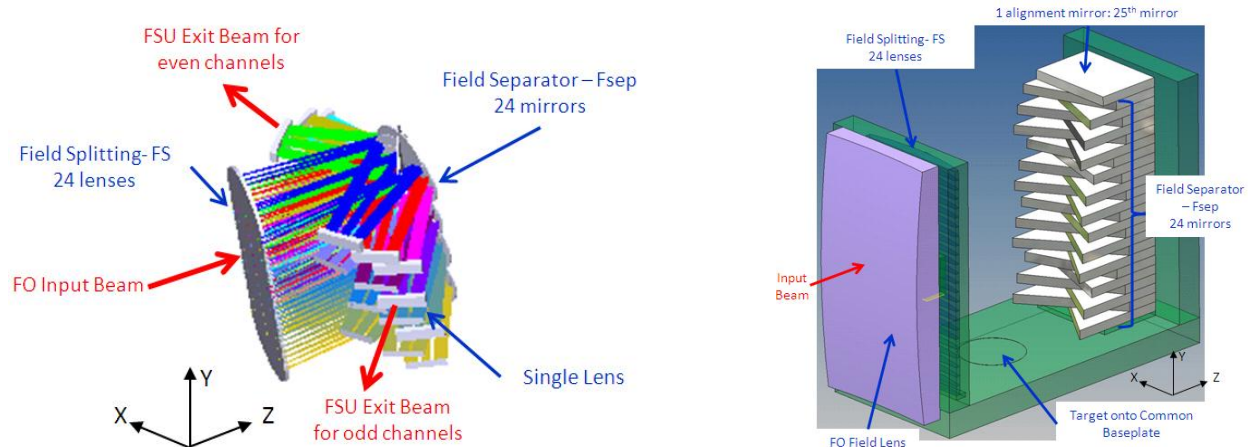

Figure 3: 3D model of the Field Splitter Unit (FSU)

3.1.1 The Field Splitting (FS)

The Field Splitting (FS) is a very important component located onto a MUSE image plane between the Fore Optics and the 24 Relay Optics. That means very good sharp edge with no chips higher than 0.03mm should be present onto the Field Splitting. It consists of 24 individual spherical plano-convex lenses, each aperture corresponding to 89.5mm x 7.37mm sub-field. Those lenses will be mounted on a plan-parallel plate as support structure. The curvature radii of those lenses are identical with a radius of 200mm and a thickness of 9mm made in fused silica. A critical issue for the FS is the light loss due to vignetting, e.g. caused by broken edges, at the boundary in between two adjacent lenses. The specification for this is 1% maximum, which corresponds to an unusable area with a width of 70 μ m. To reach this, fused silica has to be used for the base plate and the lenses themselves. After the rectangular lenses are manufactured, edge grinding and polishing produce finally the sharp edges. The array has then to be cemented onto the FS substrate plate. The AR-coating of the lenses will be done before cementing them to the FS substrate plate and can be edgeless at the long side of the lenses.

The specifications for the FS are given below:

- Material lenses and FS substrate plate: Fused Silica, e.g. Herasil; Bubbleclass B0/B1; others specs standard quality
- FS substrate plate: 1 piece 192x120x20mm; plan-parallel, parallelism <30''; surface quality <1 lambda; polishing 3 Rauten DIN3140; AR-coating: none
- Lenses: 24 pieces; free aperture (>89.5) x (>7,30), center thickness 9 \pm 0.05mm; plan-convex; flat surface quality <1 lambda; radius r=200mm, 3 / 2(0,5); 4 / 30', 5 / 2*0.04; bevels on long side (89mm): <0.025mm; AR-coating: only on convex side, Rmax <0.7% von 450-950nm
- System: 24 lenses cemented onto FS substrate plate; width of unusable area in between lenses <= 70 μ m.

3.1.2 The Field Separator (FSEP)

The Field Separator (FSEP) consists of 24 mirrors which reflect the light by the appropriate angle. This piece is also very important. The requirement onto angle should be lower than 8 arcsec in order to avoid any vignetting onto relay optics. The mirrors substrates have the shape of the reflecting prisms to allow stacking and have a high reflection coating on the hypotenuse. They are cemented on FSEP substrate plate such that the light from the odd sub-fields (No.1, 3, 5...) is reflected towards -x and the light from even sub-fields (No.2, 4, 6...) is reflected towards +x. The useful aperture is

7.37mm along y-axis and depends on channel angle along x-axis. Additionally, an auxiliary mirror, named 25th mirror, used for the alignment of the FSU is placed on top of the unit (§ 3.4).

The specifications for the FSep are given below:

- Material FSep substrate plate and mirror body: a lower quality Fused Silica as there is no pass through of the light.
- FSep substrate plate: 1 piece 192x120x20mm; plan-parallel, parallelism <30"; surface quality as needed for cementing the mirrors on; AR-coating: none
- Mirrors: 24 pieces + 1 pieces; Base side x thickness: (70+0-0.25)mm x (>7.3)mm; flat surface quality <1/4 lambda; Reflecting coating: R_avg 465-580nm > 0.97, 580-800nm > 0.98, 800-930nm > 0.97

3.1.3 The Field Splitter Unit (FSU)

The distance of the optical surfaces of the field separator and the field splitter is 150mm. For most of the channels the narrow side of the beam on the individual mirrors is less than 7mm. There is at least 0.3mm clearance to the physical edge of the mirror, which allows efficient field separation with nearly no vignetting, shadowing and overlapping (Figure 4).

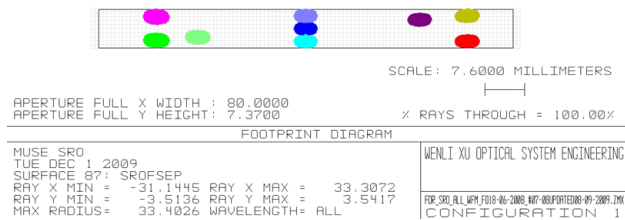

Figure 4: Footprint on the mirror of the field separator FSEP for channel 01 with minimum separation

The FS and FSep is mounted on a common base plate and aligned at the manufacturer premises. For alignment purpose, a target, named FSU Target, is engraved onto the common baseplate. After testing and alignment of the FS/FSEP unit, the field lens of the Fore Optic is cemented onto the opposite side of FS baseplate.

After testing and alignment of the FS/FSEP unit, the field lens of the FO will be cemented onto the opposite side of FS base plate.

3.2 Requirements

3.2.1 Top Level Requirements

Due to its central position onto MUSE instrument feeding 24 channels, tight specifications are set for FSU. Main performances (image quality, magnification, distortion, lateral chromatism, throughput) are driven by relay optics themselves rather than by the FSU. For example, the image quality is quite similar for all the channels. This gives an feeling of the variance of the image quality in the different channels.

Positioning, loss light and a part of exit pupil telecentricity are driven by the FSU and detailed below.

The critical points are as follow.

First, the adjacent lenses (center-to-center) have a nominal distance of 7.37 mm. The specification for the light loss is 1% maximum of the whole field, which corresponds to a maximum unusable area between two adjacent FS lenses of 70µm width. This means that the free aperture along the short side of FS lenses has to be at least 7.30 mm, i.e. it's less than 2x0.035 mm left for edge chamfering, glue and the tolerance for manufacture and assembly.

Second, as for each individual channel the FSEP mirror has the correspondence to the FS lens, the thickness of the mirrors has also to be between 7.30mm to 7.37mm. Due to the long optical path of the ROs, the tilts of the mirror surface about both long and short axes are required to deviate less than 8 arcsec from the nominal value.

Third, the absolute position tolerance in Y of the FS lens as well as the FSEP mirror should be less than ±0.020mm, the relative position tolerance in Y of whatever lens/mirror with respect to another of the 23 lenses is below ±0.010mm. The relative displacement of the center heights of the lenses and the corresponding mirrors has also to be less than 0.020mm, valid for individual rows as well as summed up for the complete slice stack.

To limit the telecentricity at the SRO exit, the curvature radius of Field Splitting should be very tight (R=200±0.5mm). A deviation of ±1mm onto the curvature radius gives a deviation of ±3 arcmin onto exit beam.

3.2.2 Alignment Requirements

The alignment requirements are constrained by the Fore optics at the FSU entrance and the 24 channels at the FSU exit.

Table 1: Alignment specifications of the FSU.

	FSU Mask with respect to (wrt) FSU references	FSU input focal plane alignment wrt MUSE references	FSU output focal plane alignment wrt with respect to 24 SRO Folding Mirrors 1 positions
x	± 0.1 mm	± 0.25 mm	± 0.5 mm
y	± 0.1 mm	± 0.125 mm	± 0.5 mm
z	± 0.25 mm	± 0.5 mm	
θ_x	± 1 arcmin	± 1 arcmin	
θ_y	± 1 arcmin	± 1 arcmin	
θ_z	± 1 arcmin	± 1 arcmin	

3.3 MUSE References

To align the FSU, the Fore Optics references are used (Figure 5). Those are internal references for alignment located onto the Extension Beam:

- Ref_{EB4} is located below the junction plate. It is an annular mirror with a target centred on it.
- Mirror M3: It is located onto Extension Beam behind the FSU position at ~ 30 mm from the end of the Extension Beam. This is a 310 x 60 x 50 mm thick mirror. One large target on a mechanical plate is composed of 4 hollow sub targets which is glued on its reflective surface. These sub targets are located at different locations along y axis:
 - M3Target1. It defines the VLT entrance optical axis which is the same as FO entrance optical axis. That is not used for FSU alignment,
 - M3Target2. It defines the positioning of FO exit optical axis, that corresponds to the FSU center,
 - M3Target3. It is located in the same location (x, y) as the 25th mirror of the FSU,
 - M3Target4. It is located at the top of FSU ie. at the same location (x, y) as a “virtual” 26th mirror of the FSU.

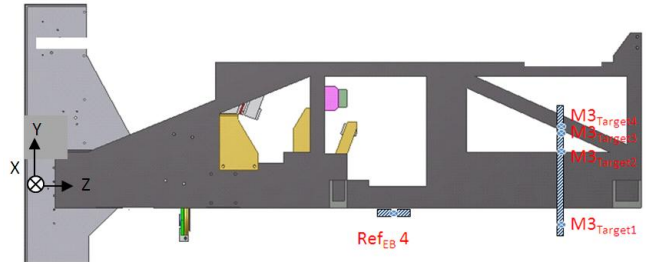

Figure 5: FO Reference Targets used for FSU alignment

All MUSE references are positioned (± 0.1 mm) and oriented (± 2 arcmin) wrt MUSE mechanical references with Romer arm.

3.4 FSU References

The FSU reference frame (O_{FSO} , X_{FSO} , Y_{FSO} , Z_{FSO}) is the main mechanical reference frame and is defined as followed:

- O_{FSO} is the right hand, bottom, front corner of the FSU when looking along the entering light direction.
- Y_{FSO} is perpendicular to the bottom plane surface of the common base plate and is directed upward.
- Z_{FSO} is the intersection of the bottom plane surface with the right hand side plane surface of the common base plate and is directed along the entering light direction.
- X_{FSO} completes the right handed system.

To align the FSU, 2 references are defined (Figure 3):

- The 25th mirror is located at the top of Field Separator (24 mirrors stack). That is a mirror with a target centred wrt FSU reference frame with an accuracy of ± 0.05 mm.
- The FSU Target is located onto the common baseplate. That is a simple target centred wrt FSU reference frame with an accuracy of ± 0.05 mm.

These 2 references are defined wrt FSU reference frame.

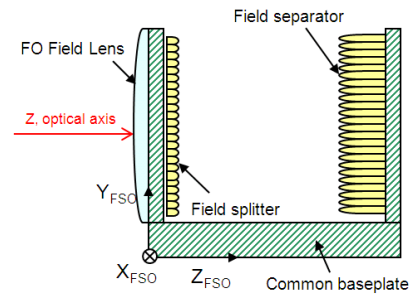

Figure 6: FSU reference frame

3.5 FSU Degrees of freedom

The Field Splitter Unit has 3 alignment degrees of freedom X, Z, and theta Y. The tolerances in the following table include the accuracy required for final alignment and the dynamic range. The adjustment means consist of 5 push pull adjustment screws: one for z-axis adjustment and the others for (x, θ y) adjustments as seen onto the Figure 7.

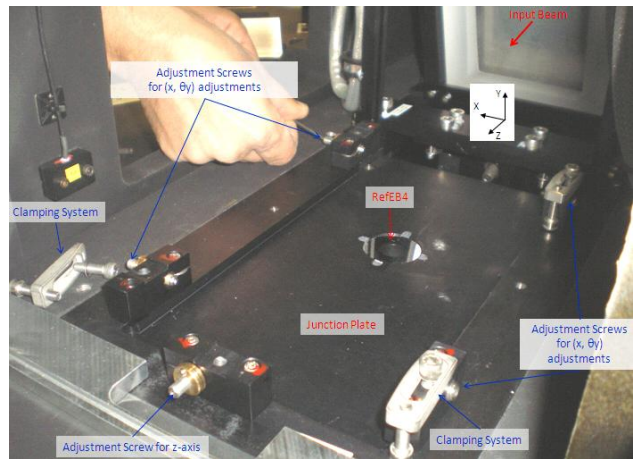

Figure 7: FSU degrees of freedom

Table 2: Positioning tolerances between FSU and junction plate

Parameter	Range	Accuracy	Means
X	± 1 mm	± 0.05 mm	Push-pull adjustment screws
Y	NA	± 0.05 mm	Plug and Play – Mechanical references
Z	± 1 mm	± 0.05 mm	Push-pull adjustment screws
θ X	NA	± 0.7 arcmin	Plug and Play – Mechanical references
θ Y	± 10 arcmin	± 0.7 arcmin	Push-pull adjustment screws
θ Z	NA	± 1 arcmin	Plug and Play – Mechanical references

4. FSU MANUFACTURING

The FSU manufacturing is a real challenge due to its size, complex system and tight tolerances. A prototype was developed by a first company but it was not into requirements in terms of sharpe edges and relative positioning of FS and FSep - [6].

The final FSU was manufactured by Winlight Optics, Pertuis, France. To reach the critical requirements given above (§3.2.1), the Field Splitter Unit is built completely from Fused Silica. The manufacturing process is shared in few parts and partially detailed here due to confidential duties:

- Manufacturing and control of common baseplate, supports and FSU references
- Manufacturing of the 24 lenses individually for the Field Splitting: Control sharpe edge (Figure 8), position of the curvature centre, vertex location wrt lens edges lower than ± 0.05 mm, thickness of each lens known at ± 0.003 mm, planarity which is 4 times the requirements (Figure 9 and Figure 10) and roughness below 1nm RMS (Figure 11 and Figure 12). Several non compliances onto chip diameter have been accepted (maximum chip of 0.05mm).

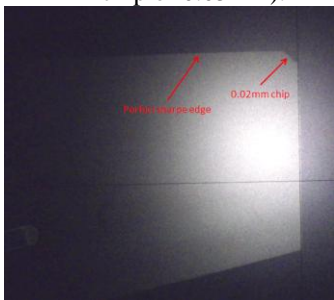

Figure 8: Sharpe edge onto lenses

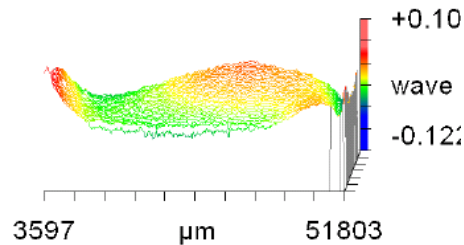

Figure 9: Example of an interferogram of flat surface of lens ($< 0.25\lambda$ PTV for λ in specification)

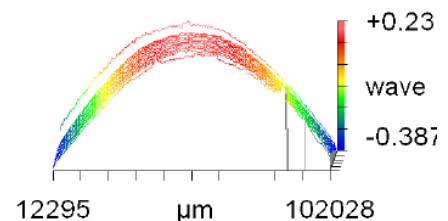

Figure 10: Example of an interferogram of spherical surface of lens ($\sim 0.5\lambda$ PTV for λ in specification)

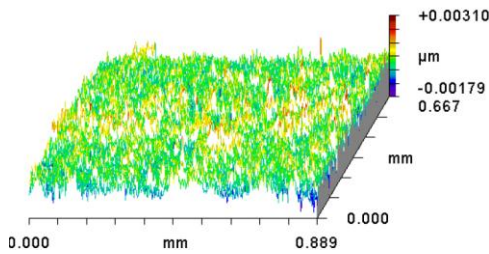

Figure 11: Example of roughness measurement of flat surface of lens (~0.5nm RMS for 3nm in specification)

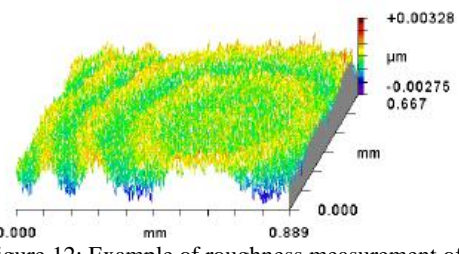

Figure 12: Example of roughness measurement of spherical surface of lens (~0.5nm RMS for 3nm in specification)

- Antireflection coating of the 24 lenses individually performed by Optics Balzers in Lichtenstein (Figure 15),
- Assembly of the stack of 24 lenses: Lenses are glued together under control of focal plane position of each lens (4µm glue thickness). Lens position is adjusted if needed. The centre of curvature of the 24 lenses is inferior to ±0.01mm in average.
- Manufacturing of the 24 mirrors individually for the Field Separator: Control of correct angle wrt assembling face which is better than 5 arcsec, sharpe edge with no chips higher than 0.03mm, planarity below 0.12λ (Figure 13), roughness of 0.5nm RMS(Figure 14) and mirror thickness below ±0.002mm.

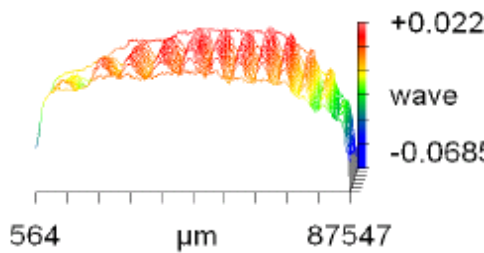

Figure 13: Example of an interferogram of active surface of mirror (~0.12λ PTV for 0.16λ in specification)

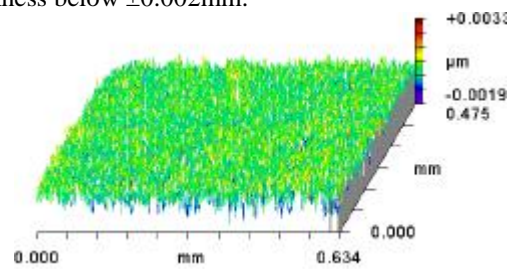

Figure 14: Example of roughness measurement of one mirror (~0.5nm RMS for 3nm in specification)

- Coating of the 24 mirrors individually (metallic reflective coating) performed by Optics Balzers in Jena (Figure 15),

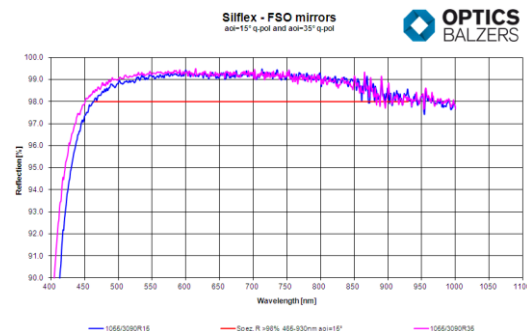
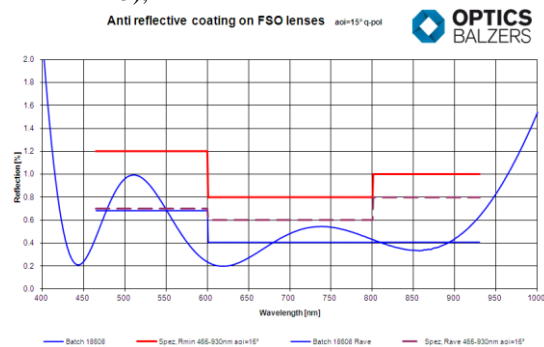

Figure 15: Left: AR coating onto FSU lenses. Right: Metallic coating onto Field Separator

- Assembly of the stack of 24 lenses: Stacked using molecular adhesion
- Control of mirrors deviation which is less than 5 arcsec that means 2 times better requirements.
- Assembly of Field Separator onto the common baseplate
- Assembly of Field Splitting onto the common baseplate
- Global test of the FSU: Control of FSU focal plane position. All positioning are compliant with tight requirement, especially relative positioning of FS wrt FSep which is lower than 0.015mm for a theoretical requirement of the whole FSU of ±0.042mm.
- Gluing of FO Field Lens which was provided by Hellma Optics. A misalignment of 5.8 arcmin in θz has been measured onto FO Field lens wrt FSU references. This misalignment is acceptable because there is no impact

onto image quality, a marginal pupil shift of 0.02mm, a maximal field shift of 0.3mm onto Folding Mirror 1 (FM1) which remains onto opto mechanical margin of FM1.

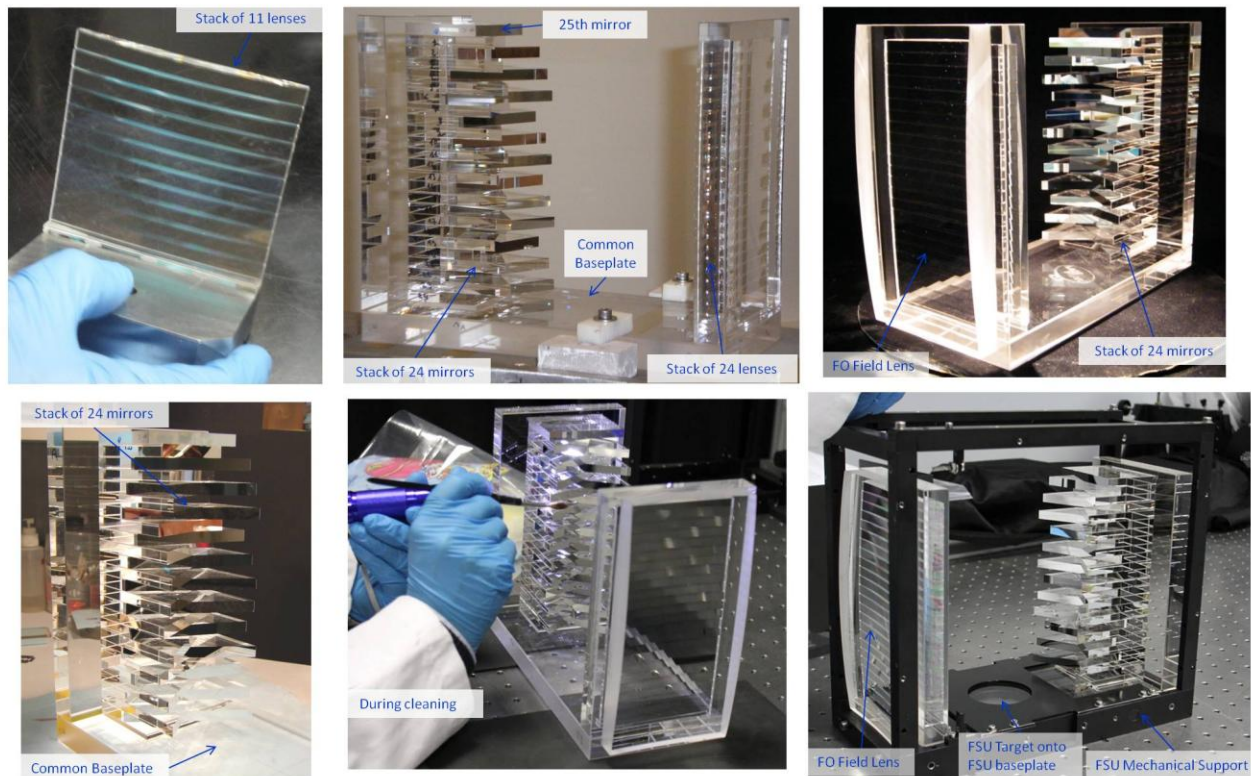

Figure 16: FSU manufacturing at different steps

In conclusion, the manufacturing performed by Winlight Optic is an achievement because it is fully compliant with very tight requirements and the manufacturing time was less than 9 months without any breadboard development.

5. DESCRIPTION OF TOOLS USED FOR ALIGNMENT

Two tools are used to align FSU onto MUSE instrument.

5.1 FSU Alignment Tool

The FSU Alignment Tool (Figure 17) is used to align the FSU wrt FO. It is composed of:

- A mechanical mount keeping all optics in position and switching them in and out the MUSE beam.
- A Sighting Telescope (ST) focusing from a finite to infinite planes. The ST is mounted onto (x, z) translation and tilt stages.
- A folding mirror at 45° deflecting the vertical beam into a horizontal beam for feeding the field separator. It is mounted onto a kinematic mount. It could be replaced by an additional target.
- A vertical translation stage along y-axis where the folding mirror is set. That allows scanning the 24 channels and the references. This translation stage could be adjusted in orientation.
- An additional target for aligning the vertical motion. It is mounted in the same place as folding mirror

5.2 Auxiliary Target

The auxiliary target allows to check the alignment of the FSU. The auxiliary target is composed of a dedicated support and a laser tracker spherical mounted reflector (SMR) - Figure 18. The auxiliary target fits onto the 24 SRO FM1 mechanical supports. Using this auxiliary target, the 24 SRO FM1 positions could be measured directly after the FSU.

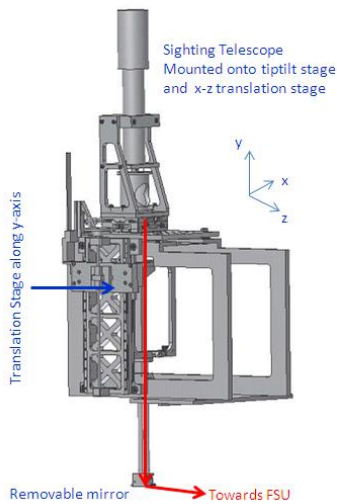

Figure 17: FSU Alignment Tool

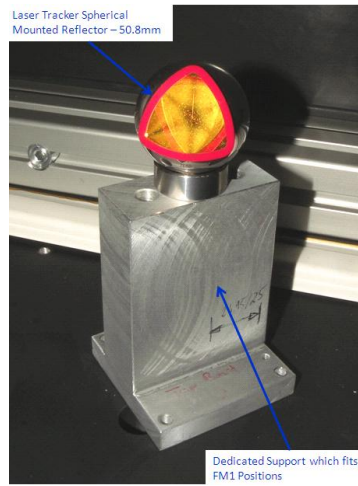

Figure 18: Auxiliary Target

6. FSU ALIGNMENT

The FSU Alignment Tool is mounted onto the top of the Extension Beam. First, the FSU Alignment Tool is aligned wrt MUSE references. Second, the FSU is installed and aligned wrt the FSU Alignment Tool. Third, the 24 FM1 positions are recorded using the FSU Alignment Tool through the FSU. At the end, the FSU is fine aligned with the best fit of the 24 FM1 positions.

6.1 Alignment of FSU and FSU Mask wrt FSU References

First, the FSU is mounted onto its frame “the FSU Mechanical Support” (Figure 19). A special mounting ensures forces to be restricted in order not to overstress and destroy or damage the common base plate of the FSU. It is aligned in its frame wrt FSU References presented in section 3.4. To reach the correct positioning of the FSU into its frame, an accurate metrology using 3D measuring machine (TESA MicroHite 3D) was performed. The frame provides the positioning of the FSU (y, θ_x, θ_z). The other degrees of freedom could be adjusted by outer screws directly onto the frame (§ 3.5).

After assembly of the FSU with its frame, the Field Mask (Figure 20) is aligned with respect to the FSU references thanks to the 3D measuring machine. Its positioning is very important because it defines the MUSE FoV. This element is attached to a frame and can be adjusted along x and y axis. The final position of Field mask gives some margins in both directions because is oversized.

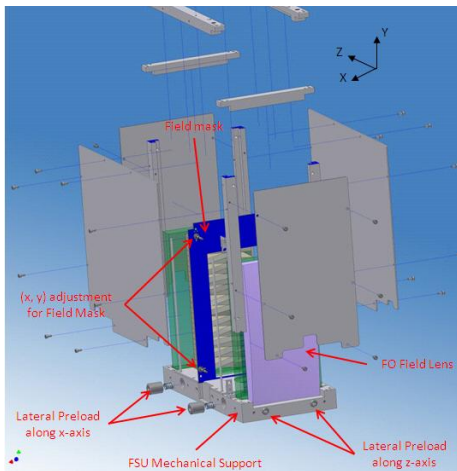

Figure 19 : Explosion view of the FSU Mechanical Support

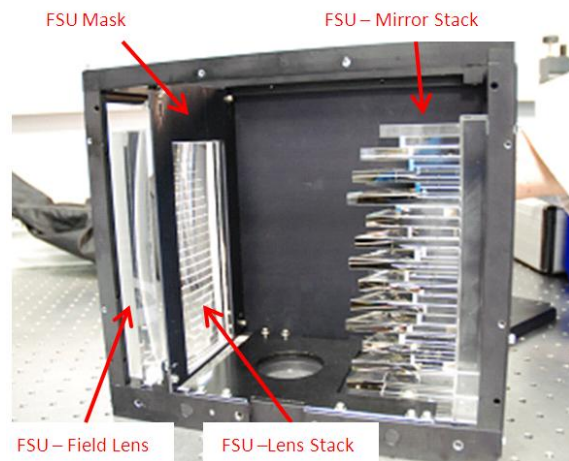

Figure 20: View of FSU Mask

The Table 4 shows the alignment results of the FSU Mask wrt MUSE references. All parameters are into specifications.

Table 3: Alignment results of the FSU Mask wrt MUSE references

Parameter	Tolerance Requirement	Measurement	Measurement Accuracy	C/NC
FSU Mask wrt FSU references	X= ± 0.1 mm Y= ± 0.1 mm Z= ± 0.25 mm $\theta_x = \pm 1$ arcmin $\theta_y = \pm 1$ arcmin $\theta_z = \pm 1$ arcmin	X= -0.045 mm Y= 0.110 mm Z= -0.223 mm $\theta_x = 0.00$ arcmin $\theta_y = 0.00$ arcmin $\theta_z = 0.0$ arcmin	X= ± 0.005 mm Y= ± 0.005 mm Z= ± 0.005 mm $\theta_x = \pm 0.25$ arcmin $\theta_y = \pm 0.25$ arcmin $\theta_z = \pm 0.1$ arcmin	C

6.2 Alignment of FSU Alignment Tool wrt MUSE References

First, the Sighting Telescope of the FSU Alignment Tool is aligned wrt MUSE references i.e. Ref_{EB4} in position (x, z) respectively in orientation (θ_x , θ_z) with a measurement accuracy of ± 0.1 mm respectively ± 0.2 arcmin (Figure 21).

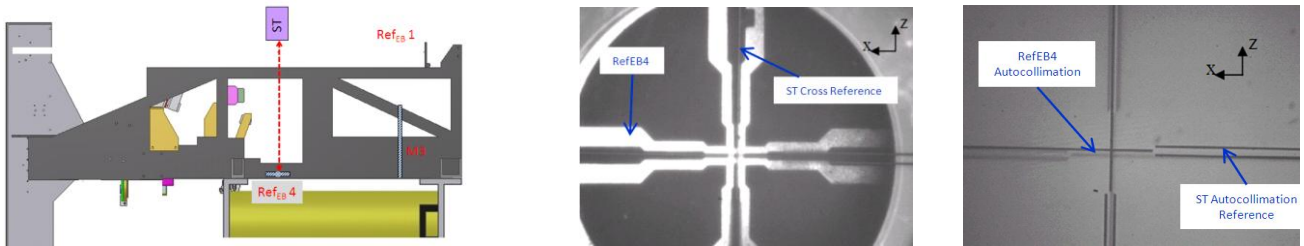

Figure 21: Left: Alignment of ST wrt RefEB4. Middle: Alignment of ST positioning (x, z) wrt RefEB4. Right: Autocollimation onto RefEB4 for ST orientation (θ_x , θ_z).

Second, the translation stage of the FSU Alignment Tool is adjusted in orientation (θ_x , θ_z) until the additional target set onto the translation arm remains stable in position onto the ST. For that, the range of the translation stage corresponds to the 24 channels and the reference along y-axis. The alignment of the translation stage is better than 0.5arcmin with a measurement accuracy of ± 0.5 arcmin (Figure 22).

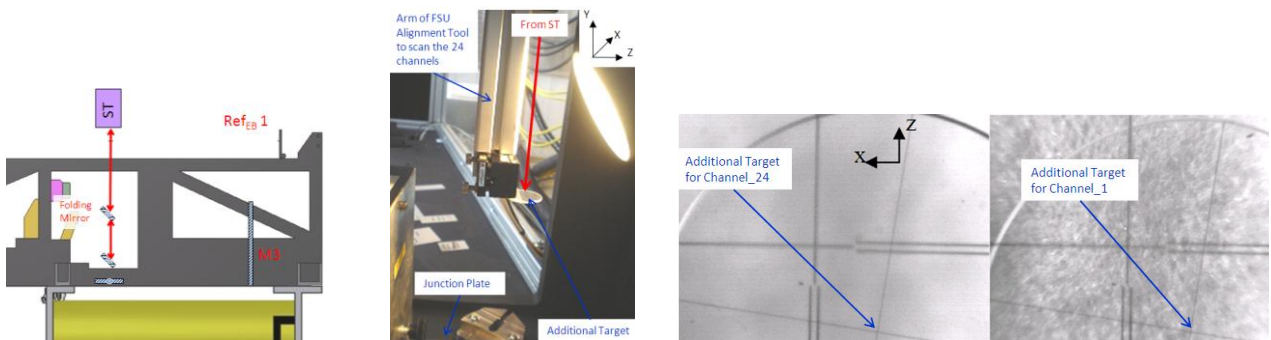

Figure 22: Left: Alignment of translation stage. Middle: Additional target for translation stage alignment. Right: Position of the additional target for channel n°1 and 24 viewed onto of ST.

Third, the folding mirror at 45° is set onto the FSU Alignment Tool. This folding mirror is aligned in orientation wrt M3 mirror. The ST is focused onto M3_{Target2}. A misalignment of $-0.15\text{mm} \pm 0.05\text{mm}$ along x-axis is recorded between M3_{Target2} and Ref_{EB4}. That corresponds to the positioning accuracy of the MUSE references with the Romer arm. The translation stage is checked in recording the M3_{Target3} position and compared to the M3_{Target2} position. There is a difference of $-0.10 \pm 0.05\text{mm}$ along x-axis and $-0.15 \pm 0.05\text{mm}$ along y-axis. This misalignment is due to the residual yaw and pitch of the translation stage.

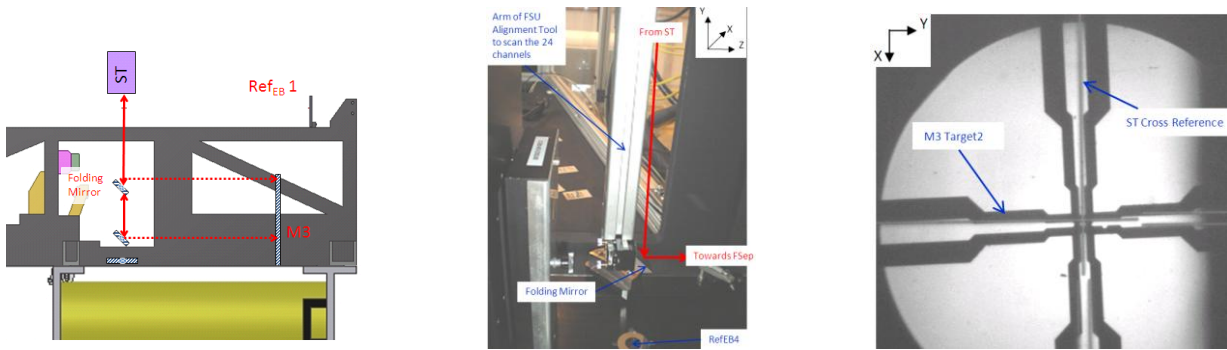

Figure 23: Left: Alignment of folding mirror wrt M3. Middle: Picture of folding mirror during its alignment. Right: Misalignment between RefEB4 and M3Target2

Fourth, the translation stage for the 24 channels is calibrated in using a folding mirror of 340mm like in Figure 23, Left, located in front of M3 Mirror. The vertical motion is unstable in orientation from Channel_1 up to Channel_24. The calibration shows a motion of ± 1.45 arcmin around x-axis and ± 1.85 arcmin around y-axis with a measurement accuracy of ± 0.2 arcmin (Figure 24). This calibration will be subtracted to the FM1 Positions (§ 6.4).

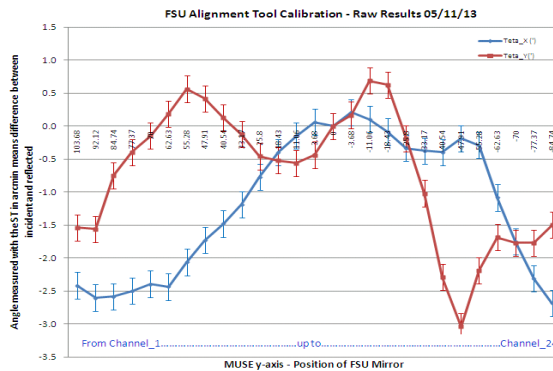

Figure 24: FSU Alignment Tool calibration for vertical motion

6.3 Alignment of FSU wrt FSU Alignment Tool

After alignment of FSU Alignment Tool wrt MUSE references, the FSU is installed onto the junction plate. The alignment of FSU wrt FSU Alignment Tool can start in 2 main steps as described onto Figure 25 and as following.

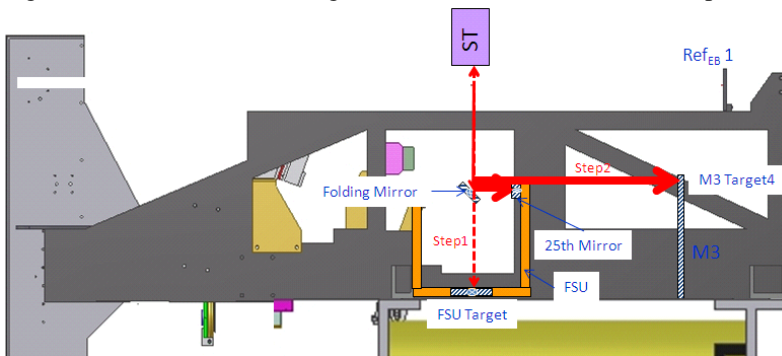

Figure 25: Overview of Field Splitter Unit (FSU) alignment

- The folding mirror is removed
- Step_1: FSU adjustment in position (x, z)
 - The FSU is adjusted in x and z until the FSU Target onto the FSU baseplate remains centred (<0.05 mm) into ST (telescope mode) - Figure 26. The FSU Target is only a target referenced wrt FSU by the supplier.
 - The FSU is checked in orientation (θ_x, θ_z) with autocollimation directly onto the baseplate (Figure 27). There is a FSU misalignment of 0.5 arcmin in both directions. No adjustments means are available for these orientations but it stays within these requirements.

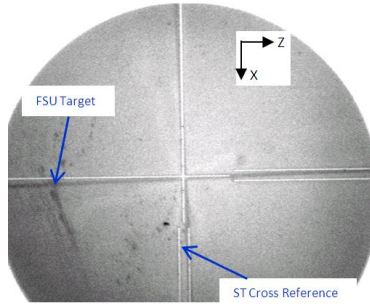

Figure 26: Centring of FSU Target onto FSU Alignment Tool

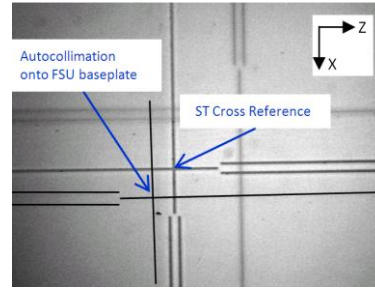

Figure 27: Autocollimation of FSU Baseplate onto FSU Alignment Tool

- The folding mirror is mounted again. Its repositioning is checked wrt M3 mirror at M3Target4 position.
- Step_2: FSU adjustment in orientation θ_y
 - With the translation stage, the folding mirror is set between the theoretical position of M3_{Target3} and M3_{Target4} corresponding to the theoretical position between the 25th mirror and the virtual 26th of the field separator in order to see at the same time the reference mirror M3 and the FSU (Figure 25, Step2).
 - The FSU is adjusted in θ_y until the FSU 25th mirror remains centred (<0.1 arcmin) into ST -Figure 28. A FSU residual angle of 0.2 arcmin around x-axis is recorded but it could not be adjusted.
 - No contingency in positioning along y-axis between M3Target3 and 25th mirror of FSep is recorded (Figure 29).

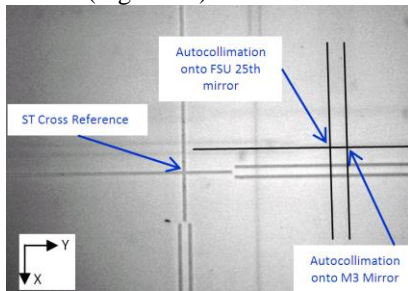

Figure 28: Autocollimation of M3 Mirror and FSU 25th mirror

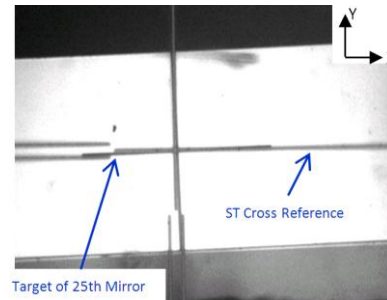

Figure 29: Centring of M25 Target

- Repeat this process until convergence between Step_1 and Step_2
- The FSU is fixed into its position thanks to 3 clamps in controlling the locking into the FSU Alignment Tool

The Table 4 shows the alignment results of the FSU wrt MUSE references. All parameters are into specifications.

Table 4: Alignment results of the FSU wrt MUSE references

Parameter	Requirement	Tolerance Requirement	Measurement	Measurement Accuracy	C/NC
FSU position wrt MUSE references	X= 0.00 mm	X= ± 0.25 mm	X= 0.00 mm	X= ± 0.05 mm	C
	Y= 0.00 mm	Y= ± 0.125 mm	Y= 0.00 mm	Y= ± 0.05 mm	
	Z= 0.00 mm	Z= ± 0.5 mm	Z= 0.00 mm	Z= ± 0.05 mm	
	$\theta_x=0$ arcmin	$\theta_x= \pm 1$ arcmin	$\theta_x=0.5$ arcmin	$\theta_x= \pm 0.1$ arcmin	
	$\theta_y=0$ arcmin	$\theta_y= \pm 1$ arcmin	$\theta_y=0$ arcmin	$\theta_y= \pm 0.1$ arcmin	
	$\theta_z=0$ arcmin	$\theta_z= \pm 1$ arcmin	$\theta_z=0.5$ arcmin	$\theta_z= \pm 0.1$ arcmin	

6.4 Measurement of FM1 Positions

The measurement of FM1 Positions i.e. FM1 mapping consists of a process to optimize the FSU position and orientation wrt the 24 channels.

- The auxiliary target (§ 5.2) are set onto the 24 corresponding FM1 mirrors (Figure 30).

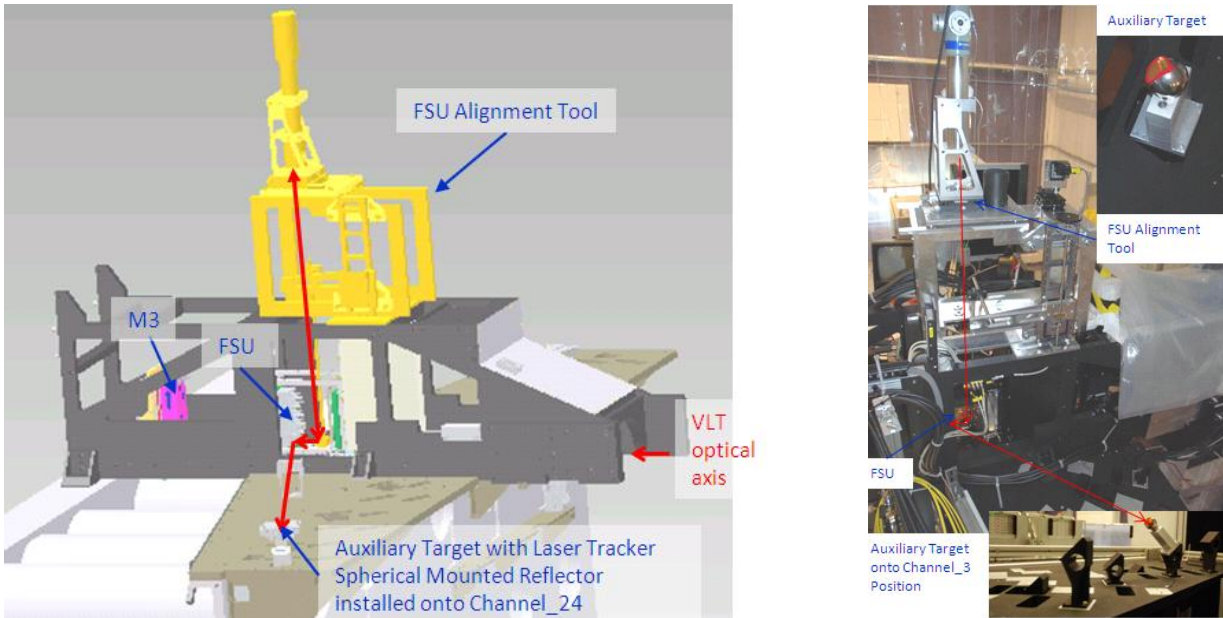

Figure 30: Set up to measure the 24 FM1 position

- Using the FSU Alignment Tool, which has been aligned with MUSE references, the 24 FM1 positioning in (x,y) are measured (Figure 31).
- These positions are corrected from the FSU Alignment Tool calibration done in section 6.3.
- These corrected positions are compared with their theoretical ones (Figure 32). The results show a misalignment of 1 mm PTV along x-axis and 1.6mm PTV along y-axis with measurement accuracy of $\pm 0.1\text{mm}$. Two channels (3 and 23) are completely out of specifications.

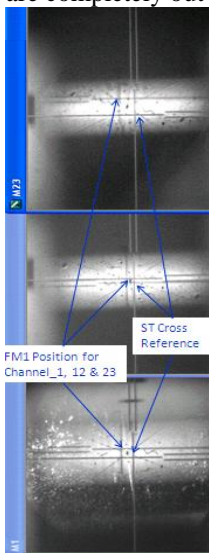

Figure 31: Example of results of FM1 mapping onto channels n°1, 12, 23

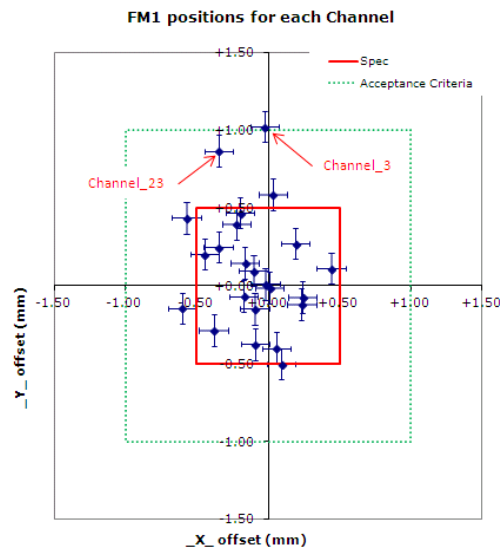

Figure 32: Corrected data for the FM1 mapping with FSU Alignment Tool calibration

The Table 5 shows the alignment results of the FSU wrt 24 FM1 Positions. Two channels are completely out of specifications. The FSU position could be optimized in both axes (§ 6.5).

Table 5: Alignment results of the FSU wrt FM1 Positions

Parameter	Requirement	Tolerance Requirement	Measurement	Measurement Accuracy	C/NC
FSU output focal plane alignment wrt with respect to 24 SRO Folding Mirrors 1 positions	X= 0.00 mm Y= 0.00 mm	X= ±0.5 mm Y= ±0.5 mm	X < ±0.5 mm Y < ±0.5 mm For 19 channels	X= ±0.1 mm Y= ±0.1 mm	C
			X < ±0.5 mm Y < ±0.5 mm In including measurement accuracy For 3 channels (5, 17 & 19)		C
			X > ±0.5 mm Y > ±0.5 mm For 2 channels (3 & 23)		NC

6.5 Fine Alignment of FSU wrt FM1 Positions

By mapping the 24 FM1 positions, the FSU position and orientation could be optimized onto SRO specification range. For that, the FSU could be readjusted in x, z and θ_y wrt FM1 mapping until it stays inside FO tolerances and reaches the best compromise on the 24 paths. Using results performed in § 6.4, that is impossible to readjust the FSU in order to set the channel 3 and 23 into the requirements without degrading others channels. In the MUSE case, the FSU was not readjusted. Nevertheless, the 2 non compliances could be acceptable due to margins onto SRO folding mirror sizes. During SRO channel alignment, the vignetting onto channel 3 and 23 should be carefully checked.

Before the FSU locking, due to the small separation between mirrors (§ 3.1.3), the footprint onto the Field Separator coming for the MUSE pre-optic is checked onto few mirrors. No vignetting appears.

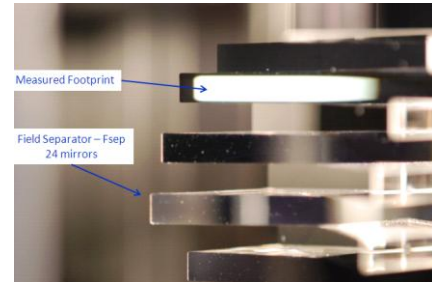

Figure 33: Measured footprint onto Field Separator

6.6 FSU Locking Process

The FSU is clamped at nominal torque of 6 N.m with the 4 clamping systems described onto the Figure 7. During the clamping, all parameters except z-axis which has large tolerance are checked at the same time:

- (x, y, θ_x , θ_y) with FSU Alignment Tool onto the FSU 25th mirror,
- (θ_z) with an additional autocollimator located onto the FSU side locking the edge of the Field Splitting Plate.

6.7 Single Lens towers Mounting

No alignment is done. The Single Lens towers are set onto their mechanical position (Figure 34). Three screws for each tower are needed: 2 for x-axis clamping and 1 for y-axis. First, screws along x-axis are screwed down (alternately each screw) until spring washers flattening. Then, these screws are unscrewed a little bit (1 turn) and screw along y-axis is screwed down until contact between towers and reference plate. At the end, the x-axis is screwed down. During the screwing, FSU alignment is checked with the same set up as presented in section 6.6.

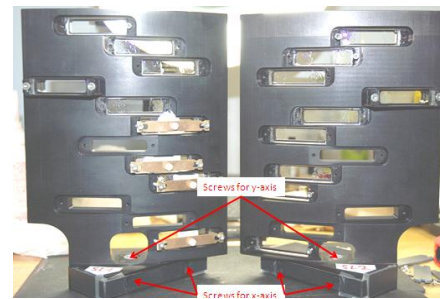

Figure 34: Single Lens Towers mounting screws

6.8 FSU Final Locking

The FSU final locking was done by gluing with the 3M DP110 glue the FSU mechanical support onto the junction plate.

7. MUSE RESULTS

After the FSU alignment, the 24 channels are aligned one by one using an IFU-Simulator (Figure 35) - [3]. This powerful tool allows to:

- Align the FoV and Pupil coming from {CU+FO+SRO} ($\pm 0.1\text{mm}$; $\pm 0.02^\circ$),
- Perform image quality of {CU+FO+SRO},
- See any vignetting into all SRO optical components planes.

It is installed at each IFU location and uses the same interface.

The fine adjustment does concentrate on the folding mirrors FM1&2 of SRO that will feed the each Integral Field Unit. The tolerances of the imaging lenses (doublets 1&2) are not very tight, therefore mechanical tolerances are sufficient and do not need extra alignment. Fine-adjustment is performed into the relay path by squaring up (x, y, z) and centering (θ_x , θ_y) the beam on the IFU-simulator with Folding Mirrors 1&2 (FM1 resp. FM2) (θ_x , θ_y) resp. (z, θ_x , θ_y) in few iterative processes.

After each channel alignment, global parameters (position, image quality and vignetting) are checked at each IFU entrance. These results validate the alignment of the MUSE pre-optics especially the FSU. The results onto the 24 channels are excellent showing no vignetting, high image quality and correct positioning - [3].

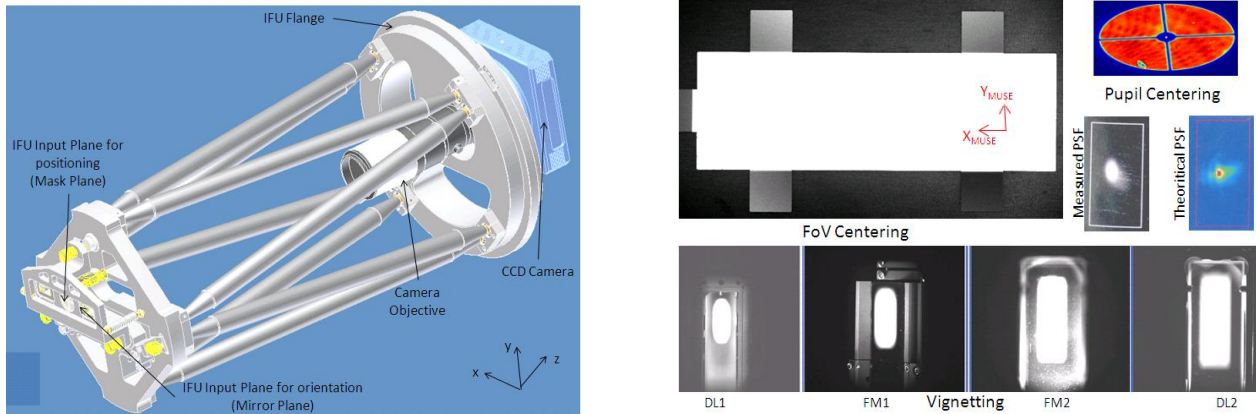

Figure 35 : Left: General View of IFU Simulator. Right: Results of SRO Alignment with IFU Simulator: FoV and Pupil Centering, PSF and vignetting

The success of this alignment procedure is demonstrated by the excellent results obtained during technical and commissioning nights onto MUSE image quality and throughput directly onto the sky. A MUSE detailed results of the end-to-end tests are presented by Richard et al. during this conference [3].

8. CONCLUSION

This paper describes the manufacturing, the alignment and tests onto the MUSE main component: the Field Splitter Unit (FSU). It cuts the MUSE Field of View in 24 parts and redirects the beam into 24 directions feeding 24 Integral Field Unit. That is the most important component of MUSE instrument. Due to its location into an image plane located between the Fore Optics and the 24 Relay Optics, tolerances are very tight. Chips are not acceptable. The maximal angle deflection is 8 arcsec. In spite of tight tolerances, the manufacturing performed by Winlight Optics is fully compliant with requirements. Its alignment onto MUSE instrument allows to develop accurate tools. The success of the Field Splitter Unit alignment is demonstrated by the excellent results obtained during Lyon Preliminary Acceptance (Sept, 13) and during technical and commissioning nights at VLT (Jan, 14) onto MUSE positioning, image quality and throughput directly onto the sky.

ACKNOWLEDGMENT

We thank all the member of the MUSE team of this ESO international project at CRAL/Lyon, IRAP/Toulouse, IAG/Göttingen, AIP/Potsdam, Leiden Obs, ETH/Zürich and ESO/Garching for their invaluable contribution. This work was strongly supported by MUSE management and technical teams. We thank especially ESO, CNRS/INSU and University Claude-Bernard Lyon I for their strong support to the MUSE project.

REFERENCES

- [1] Bacon R. et al., "Highlights from the Multi unit Spectroscopic Explorer (MUSE), a 2nd generation VLT instrument for the VLT," Proc SPIE 9147, 506 (2014)
- [2] Nicklas H. et al., "Performance of the main instrument structure and the optical relay system of MUSE," Proc SPIE 8446, 223 (2012)
- [3] Laurent F. et al., "A Powerful Alignment and Performance Tool for MUSE instrument," Proc. SPIE 9151, 69 (2014)
- [4] Caillier P. et al, "MUSE instrument performance through time from design to the sky," Proc SPIE 9147, 224 (2014)
- [5] Richard J. et al., "VLT/MUSE global performances as measured during commissioning," Proc. SPIE 9147, 113 (2014)
- [6] Xu W. et al., "MUSE Splitting and Relay Optics: a Fan-shaped Bridge for 24 Spectrographs," Proc. SPIE, (2011)