



HAL
open science

IFU Simulator: A Powerful Alignment and Performance Tool for MUSE instrument

Florence Laurent, Didier Boudon, Eric Daguisé, Jean-Pierre Dubois, Aurélien Jarno, Johan Kosmalski, Laure Piqueras, Alban Remillieux, Edgard Renault

► **To cite this version:**

Florence Laurent, Didier Boudon, Eric Daguisé, Jean-Pierre Dubois, Aurélien Jarno, et al.. IFU Simulator: A Powerful Alignment and Performance Tool for MUSE instrument. SPIE Astronomical Telescopes + Instrumentation, Jun 2014, Montréal, France. pp.91511Z, <10.1117/12.2057097>. <hal-04785478>

HAL Id: hal-04785478

<https://hal.science/hal-04785478v1>

Submitted on 15 Nov 2024

HAL is a multi-disciplinary open access archive for the deposit and dissemination of scientific research documents, whether they are published or not. The documents may come from teaching and research institutions in France or abroad, or from public or private research centers.

L'archive ouverte pluridisciplinaire **HAL**, est destinée au dépôt et à la diffusion de documents scientifiques de niveau recherche, publiés ou non, émanant des établissements d'enseignement et de recherche français ou étrangers, des laboratoires publics ou privés.



HAL Authorization

IFU Simulator: A Powerful Alignment and Performance Tool for MUSE instrument

Florence Laurent^{*a}, Didier Boudon^a, Eric Daguisé^a, Jean-Pierre Dubois^a, Aurélien Jarno^a, Johan Kosmalski^a, Laure Piqueras^a, Alban Remillieux^a, Edgard Renault^a

^aUniversité de Lyon, Lyon, F-69003, France/ Université Lyon 1, Observatoire de Lyon, 9 avenue Charles André, Saint-Genis Laval, F-69230, France/ CNRS, UMR 5574, Centre de Recherche Astrophysique de Lyon/ Ecole Normale Supérieure de Lyon, Lyon, F-69007, France

ABSTRACT

MUSE (Multi Unit Spectroscopic Explorer) is a second generation Very Large Telescope (VLT) integral field spectrograph (1x1arcmin² Field of View) developed for the European Southern Observatory (ESO), operating in the visible wavelength range (0.465-0.93 μm). A consortium of seven institutes is currently commissioning MUSE in the Very Large Telescope for the Preliminary Acceptance in Chile, scheduled for September, 2014.

MUSE is composed of several subsystems which are under the responsibility of each institute. The Fore Optics derotates and anamorphoses the image at the focal plane. A Splitting and Relay Optics feed the 24 identical Integral Field Units (IFU), that are mounted within a large monolithic instrument mechanical structure. Each IFU incorporates an image slicer, a fully refractive spectrograph with VPH-grating and a detector system connected to a global vacuum and cryogenic system. During 2012 and 2013, all MUSE subsystems were integrated, aligned and tested to the P.I. institute at Lyon. After successful PAE in September 2013, MUSE instrument was shipped to the Very Large Telescope in Chile where that was aligned and tested in ESO integration hall at Paranal. After, MUSE was directly transferred in monolithic way without dismounting onto VLT telescope where the first light was overcame.

This talk describes the IFU Simulator which is the main alignment and performance tool for MUSE instrument. The IFU Simulator mimics the optomechanical interface between the MUSE pre-optic and the 24 IFUs. The optomechanical design is presented. After, the alignment method of this innovative tool for identifying the pupil and image planes is depicted. At the end, the internal test report is described. The success of the MUSE alignment using the IFU Simulator is demonstrated by the excellent results obtained onto MUSE positioning, image quality and throughput. MUSE commissioning at the VLT is planned for September, 2014.

Keywords: Optical alignment, Integration, Performances, Simulator, MUSE instrument

1. INTRODUCTION

Built for the European Southern Observatory (ESO) for the second generation VLT instrumentation, MUSE (Multi Unit Spectrograph Explorer) is installed on the Very Large Telescope (VLT), Telescope Unit 4 (UT4), Nasmyth platform B for its first light the 7th of February, 2014. MUSE is an innovative IFS, named Integral Field Unit (IFU) in MUSE instrument, which combines a 1'x1' Field of View (FoV), with a spectral resolution reaching 3000 and a spatial sampling of 0.2'' matching the spatial resolution provided by a ground layer adaptive optics system named GALACSI. MUSE operates in a large visible spectral range (0.465 – 0.93 μm) with 2 functional modes a Wide Field Mode (WFM) and a Narrow Field Mode (NFM) where the latter has an eight times higher spatial resolution - [1].

*florence.laurent@univ-lyon1.fr; phone 33 4 78 86 85 33; fax 33 4 78 86 83 86; <http://cra.univ-lyon1.fr/>

The MUSE instrument is composed of a Calibration Unit, a Fore-Optic which includes an optical derotator and an anamorphoser by 2, a splitting optics cutting the FoV in 24 parts and 24 relay optics which feed 24 identical IFUs (Figure 1). Each IFU is composed of an original advanced image slicer associated with a high-throughput spectrograph with a Volume Phase Holographic Grating (VPHG) and a 4k×4k CCD detector.

This paper describes the manufacturing, alignment and tests of main tool which allows to align the 24 channels into MUSE instrument. The aims are to:

- Set the technical requirements,
- Describe the IFU Simulator,
- Set out the alignment procedure and its internal results,
- Present its using into MUSE instrument.

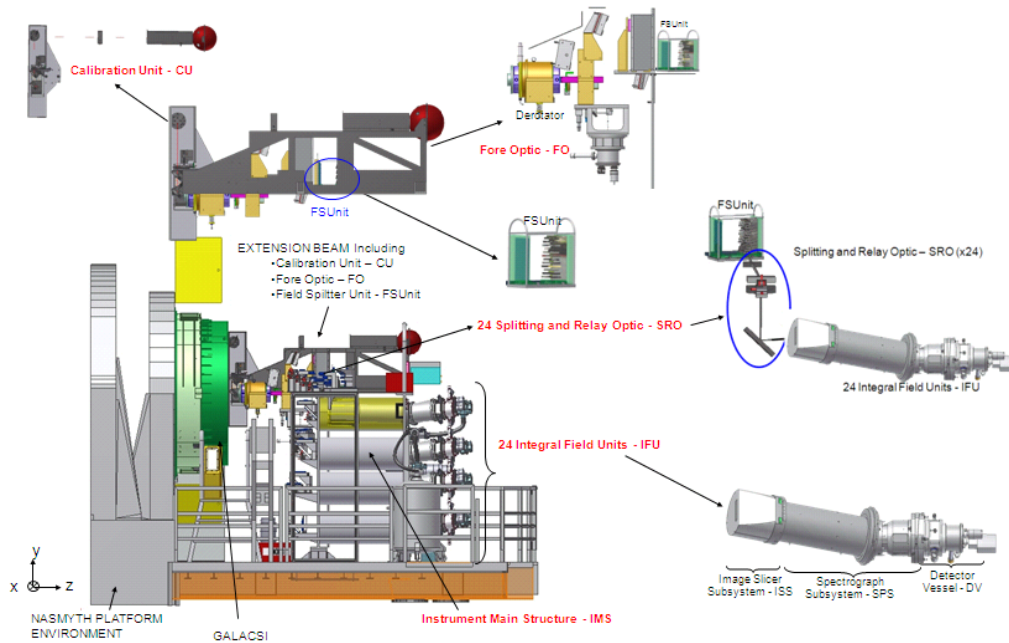

Figure 1: MUSE Mechanical Overview

2. TECHNICAL SPECIFICATIONS

The 24 channels are aligned one by one using an IFU-Simulator. This powerful tool is the main tool to align the Relay Optics. It allows to:

- Align the (x, y, θ_z) FoV and (x, y) Pupil of the MUSE 24 channels i.e. coming from $[CU+FO+SRO n^o i]$ ($\pm 0.1\text{mm}$; $\pm 0.02^\circ$) in WFM&NFM modes,
- Perform image quality and magnification of $[CU+FO+SRO n^o i]$ in WFM&NFM,
- See any vignetting into all SRO optical components planes.

The IFU Simulator is used in different locations following integration steps (Lyon, Paranal base camp, Paranal telescope). It is used at different angle θ_z (from -70.88° up to -31.87° and from 31.87° up to 70.88°).

The IFU Simulator allows to see directly the alignment the 24 channels when the folding mirrors FM1&2 of SRO are adjusted. The alignment in FoV and pupil is performed following an iterative process.

One other constraint to align each channel is that the allocated time to align one channel should be lower than 4 hours with 2 persons.

2.1 Top level Requirements

For the IFU Simulator, the system requirements are the following (Table 1).

Table 1: Alignment specifications of the IFU Simulator itself.

	IFU Simulator Repositioning	IFU Simulator - Mask Positioning	IFU Simulator Detection Unit
x	± 0.015 mm	± 0.1 mm	± 0.035 mm
y	± 0.015 mm	± 0.1 mm	± 0.035 mm
z	± 0.01 mm	± 0.5 mm	± 0.17 mm
θ_x	± 0.25 arcmin	± 1 arcmin	± 0.33 arcmin
θ_y	± 0.25 arcmin	± 1 arcmin	± 0.33 arcmin
θ_z	± 0.5 arcmin	± 2 arcmin	± 0.5 arcmin

2.2 MUSE References

The IFU reference frame is part of MUSE references. That is the reference axes for the IFU Simulator (Figure 2). ($O_{IFU}, X_{IFU}, Y_{IFU}, Z_{IFU}$) is attached to the mechanical interface called IFU Flange between the MUSE Structure and each IFU:

- O_{IFU} is the center of the mechanical circular interface flange at the level of the front contact surface plane.
- Z_{IFU} is directed from point O_{IFU} and perpendicular to the flange plane and towards the MUSE Detector.
- X_{IFU} is perpendicular to Z_{IFU} and parallel to the spatial direction
- Y_{IFU} completes the right handed system and is parallel to the spectral direction.

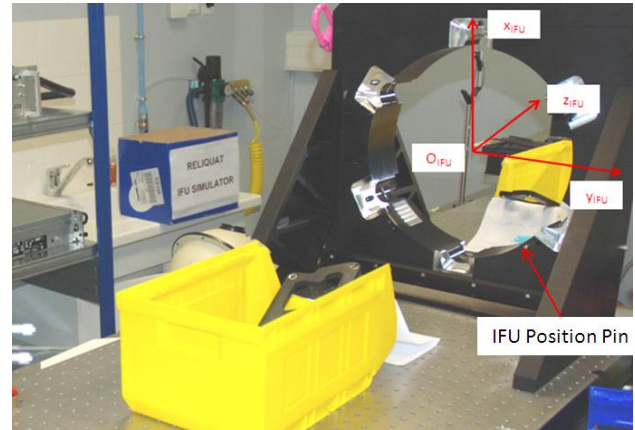
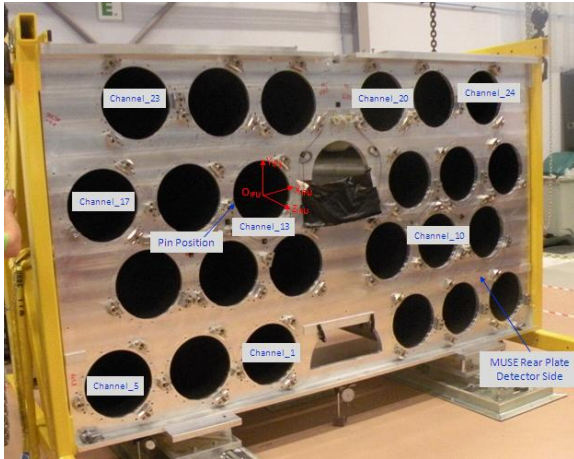

Figure 2: Left: IFU reference frame designed onto MUSE Structure. Right: IFU reference frame designed onto dedicated support

3. DESCRIPTION

3.1 Final Design

The IFU Simulator is composed of three main parts:

- The interface. That is the same as IFU called IFU Flange which is the reference for SRO/IFU interface.
- A Mask located into the IFU entrance plane. The extremity part is dedicated to {CU+FO+SRO} alignment, image quality and vignetting tests.
- A Detection Unit with a camera objective, a teleconverter x2 and Apogee CCD to record the FoV and pupil. This detection could sight from IFU input plane to infinity.

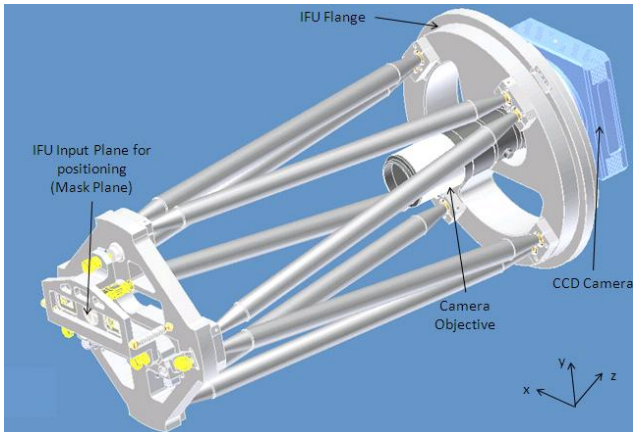

Figure 3 : General View of IFU_Simulator

3.1.1 The Interface

The IFU Simulator uses the same interface as IFU called IFU Flange (Figure 2).

3.1.2 The Mask i.e. IFU Input Plane

The IFU Input Plane is materialized by a mask located at the IFU entrance Plane i.e at 682.7mm from the IFU Flange. It is composed of 3 parts (Figure 4):

- One located at the extremity of the FoV. That is the main part used for SRO alignment,
- One at the FoV centre of each channel,
- One located at the other extremity of the FoV. That is used to align the mask onto its barrel in θ_z .

Due to size of the IFU entrance plane (133.6mm), the IFU Simulator can sight a quarter of IFU FoV in x-axis and the full FoV along y-axis. The positioning of mask onto its barrel wrt its reference is ensured by the mechanical manufacturing and will be check with 3D measuring machine.

This barrel is mechanically linked to the IFU Flange by 6 tubes arranged in Serrurier truss made of carbon fiber to avoid mechanical flexion. Several lockable adjustments (x, y, θ_x , θ_y , θ_z) are given by few screws located onto barrel sides (Figure 5).

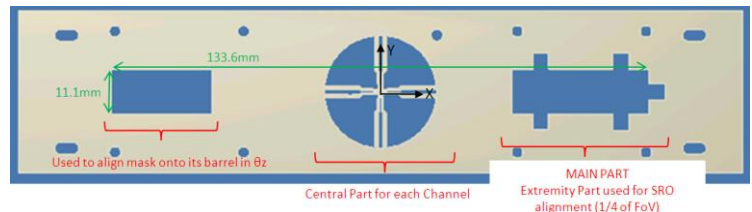

Figure 4 : Mask view into IFU Input Plane

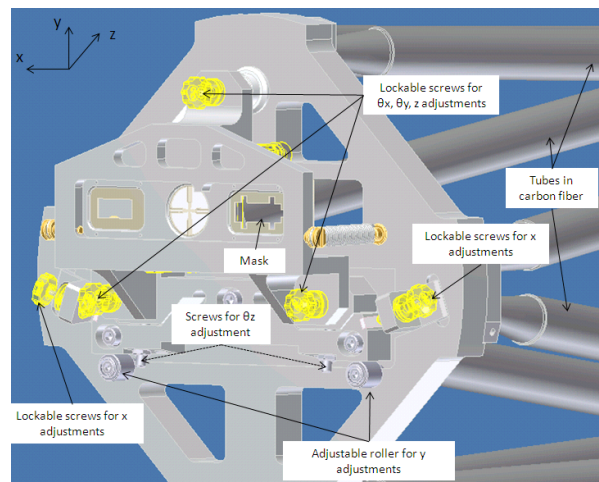

Figure 5 : Mask with adjustments

3.1.3 The Detection Unit

The Detection Unit is composed of camera objective and CCD camera. That is directly attached onto the IFU Flange without adjustment because the Detection Unit is calibrated.

The CCD Camera is an Apogee Alta U16M with pixel size of $9\mu\text{m}$ for detector area of 4096×4096 pixels².

To fulfill tight tolerances in IFU entrance plane and MUSE mechanical emcumbrance, the camera objective is composed of several parts, especially a custom made motorization (Figure 6).



Figure 6: General view of camera objective {Nikon Adaptor + Teleconverter x2 + Motorization + Camera Objective}

It consist of:

- Nikon adaptor to interface camera objective onto CCD Camera
- Teleconverter x2, Conversion lens 2x TELEPLUS PRO 300 DG by Kenko. This teleconverter x2 allows to multiply the camera objective working distance by 2 and to keep 1:1 reproduction ratio. That means that the detection unit is located at the IFU Flange location.
- Motor and Controller (Figure 11). It allows to shift between the 2 different planes (pupil and FoV) using a controller .It is composed of a Maxon motor/reducer/encoder and located around the teleconverter.
- Nikon camera objective. That is 200mm f/4D ED-IF AF Micro NIKKOR with minimum working distance of 250mm, a 1:1 reproduction ratio, custom made motorized and interfaced directly onto teleconverter x2.
- To improve stability when IFU simulator is rotated around z-axis, a special pedestal is manufactured (Figure 12).

To fulfill requirements in time and stability, the focus of the camera objective have been custom made motorized (Figure 7). Due to mechanical encumbrance and the weight, the choice of the components was not easy. For that, the autofocus standard control of the teleconverter (Figure 8) has been used and modified. This static component, which passes through the teleconverter, has been equipped of a gear. With a set of gears and gearmotor (Figure 9), the control of the camera objective is translated onto the edge.

To access to the gear, a small part of the teleconverter has be machined. A ring including the set of gears and motor has been installed onto the teleconverter (Figure 10). The positioning of ring and teleconverter is tight in order to fulfill the gearing.

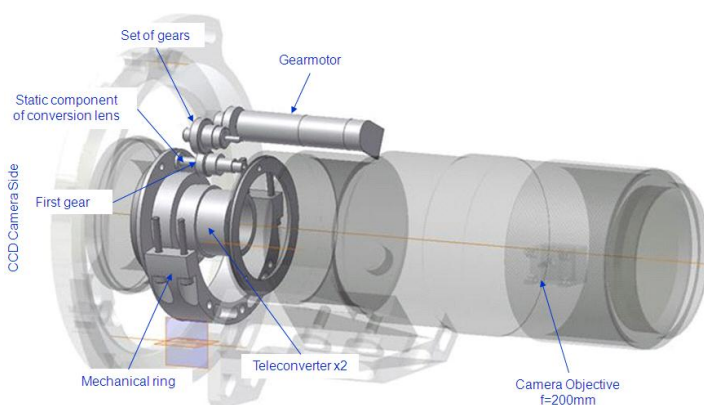

Figure 7: Mechanical drawing of custom made motorized function

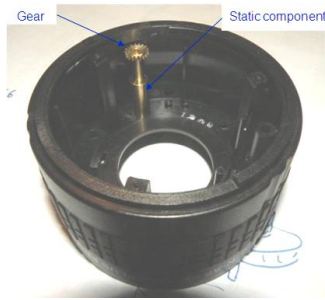

Figure 8: The autofocus standard control of the teleconverter

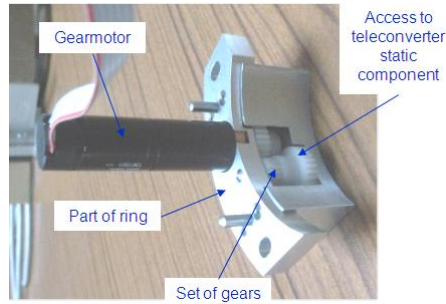

Figure 9: Picture of set of gears and gearmotor

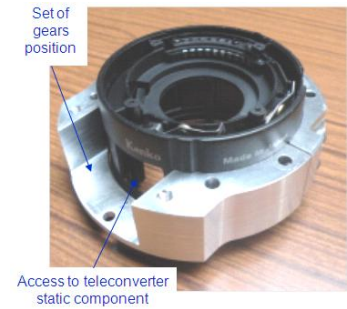

Figure 10: Picture of mechanical ring onto teleconverter

The gearmotor associated with an incremental encoder is driven by an in-house designed electronic board, connected to a laptop through a USB interface. In order to limit the amount of cables, the board includes a 2-port USB 2.0 HUB, with one port connected to the internal AVR micro-controller and the other port connected to the Apogee Alta CCD camera. For the same reason, the board is fully USB powered, using big capacitors to reduce the inrush current seen by the USB port when the motor starts moving. The AVR micro-controller is loaded with an embedded software controlling the USB interface and using a software PID motion controller. The encoder used on the motor being incremental, a calibration sequence starts when the board is first powered. The motor moves towards one direction at slow speed while the current is measured. When the encoder stops moving and the current suddenly increases, the physical limit of the Nikon camera objective is detected. The same operation is then done towards the other direction. On the computer side, a Software developed in Python and PyQt, which can run under Microsoft Windows or GNU/Linux OS, interacts with the USB interface and provides users with a graphical interface (Figure 11).

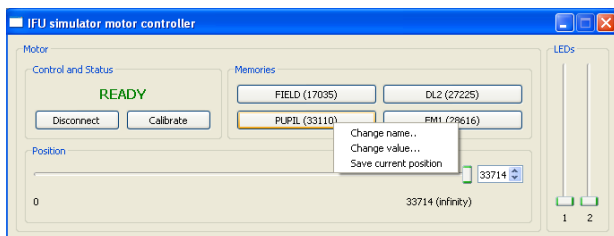

Figure 11: IFU simulator motor controller when “Memories” are changed



Figure 12: Mechanical drawing of the special pedestal

3.2 Design Evolution

The IFU Simulator design has moved in 3 versions. The technical requirements remain the same.

Into the first version, the detection unit was not stable in position and orientation due to the heavy mechanical interface between Detection Unit and IFU Flange. Moreover, the mask which is centred onto the FoV was not adapted to MUSE configurations.

The second version looks like the final version except that the camera objective was not motorized. To delete heavy mechanical interface, a teleconverter by 2 was inserted in order to directly attach the Detection Unit onto the IFU Flange. With the second version, the IFU Simulator was still unstable and spent time to align due to manual shift of camera objective.

The third version i.e. the last one which is described before (§ 3.1), introduces the in-home motorized camera objective. No manual actions were done onto the IFU Simulator during alignment. Moreover, to increase the stability, all screws and adaptive rings are glued with 3M DP110 glue.

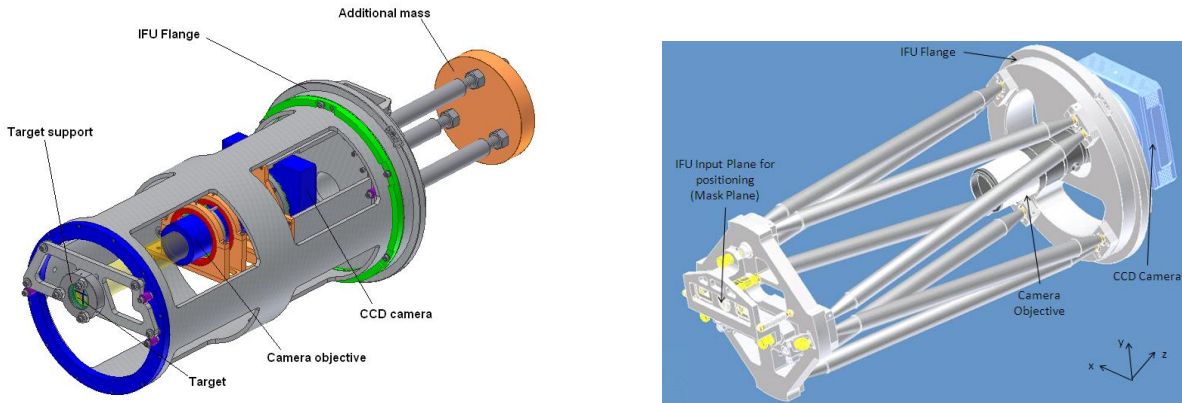

Figure 13: Left: First version of IFU Simulator. Right: Third and last version of IFU Simulator

4. ALIGNMENT PROCEDURE

All opto-mechanical parts are mounted together in CRAL mechanical workshop

4.1 IFU Input Plane Alignment

4.1.1 Mask Integration into its barrel

The mask integration wrt its barrel is performed as following:

- Acceptance of the target from the supplier: Check mechanical dimensions of the target wrt position pins onto the 3D measuring machine in camera mode x25.
- Check all dimensions specified onto the mechanical drawing
- Mount the target onto its barrel
- Clamp barrel onto the 3D measuring machine in camera mode with camera objective x25.
- Measure the extremity target positioning wrt its barrel in $(x, y, \theta z)$ in 12 points (see references onto Figure 14)
- Measure the centre of target wrt its barrel in (x, y) in 12 points (Figure 14)
- Note the offsets

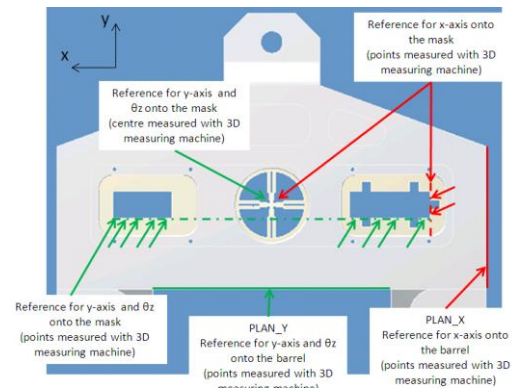

Figure 14 : References for target measurement wrt its barrel with 3D measuring machine

4.1.2 Reference in orientation

The goal of this step is to define a reference in orientation for IFU Simulator performance.

The test support is installed onto an optical bench. The alignment mirror is clamped onto the IFU Flange at rough positioning ($x=0, y=43 \text{ mm}, \theta z=0^\circ$). The alignment mirror consists of a rectangular mirror (370x70x30mm) which could be clamped to IFU Flange as described onto Figure 15. An autocollimator mounted onto $(\theta x, \theta y)$ stage is mounted in front of the alignment mirror. It is adjusted wrt alignment mirror in tip tilt until autocollimating beam remains centred onto the autocollimator. The autocollimator is clamped. The alignment mirror repositioning is checked. The autocollimator is the reference for the orientation for the IFU Simulator alignment. The alignment mirror is removed.

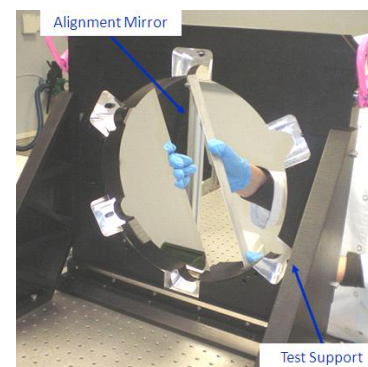

Figure 15: Alignment mirror clamped onto IFU Test Support

4.1.3 Reference in position

The goal of this step is to define a reference in position for IFU Simulator alignment. The IFU Flange consists of the reference in positioning.

The IFU Flange Reference is measured with Romer Arm as following:

- The plane in 100 points (define z-axis),
- The flange cylinder in 100 points (define (x, y) center),
- The pin in 40 points (define θz orientation).

Note that the measurement is still done until the measurement error is lower than 0.03mm.

- Build the reference coordinate system in order to match the MUSE Reference Frame defined in section 2.2
- Install IFU Simulator onto Test Support by hands

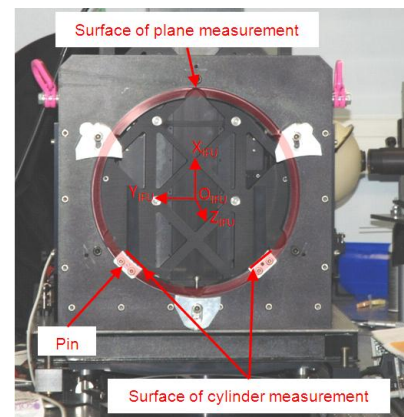

Figure 16: Reference in position – IFU Flange measurement

4.1.4 Mask Alignment wrt IFU Flange

The goal of this step is to align and fix in position the mask which materializes the IFU entrance plane. The procedure is as following:

- The mask positioning in (z, θx , θy) is adjusted during the first step because is less sensitive due to large tolerances. The procedure is:
 - Measure the mask plane (10 points). Comparison with reference frame ($z_{\text{nominal}}=-682.7\text{mm}$; $\theta x=\theta y=0^\circ$). Adjustments with the 3 dedicated screws located onto the barrel of the mask (Figure 5). Locked in position. Iterative process
- The mask positioning in (x, θz) is adjusted as following:
 - Measure PLAN_Y and PLAN_X (plane of 10 points) (Figure 14), Comparison with reference frame, Adjustment of (x, θz) with dedicated screws (Figure 5), Iterative process
- The mask positioning in y axis is adjusted as following:
 - Measure PLAN_Y (plane of 10 points) (Figure 14), Adjustment by manufacturing of 2 rollers (Figure 5), Locked in position with 5 N.m torque wrench. Iterative process

At the end, all mechanical dimensions are measured again with Romer arm. If necessary, iterative process could be performed again.

4.2 Detection Unit Calibration (Field and Pupil positions)

The goal is to determine the 2 positions for the Detection Unit (Field and Pupil positions). For that, the camera objective is set with an aperture of $f/D=8$.

In using IFU Simulator motor controller (§ 3.1.3), the camera objective focus is adjusted until the autocollimator reticle is on focus onto the CCD camera (Figure 17). This position noted “PUPIL” onto Motor controller is recorded. The centre of the reticle (x, y) is determined and consists of the reference in orientation for SRO pupil alignment (Figure 17).

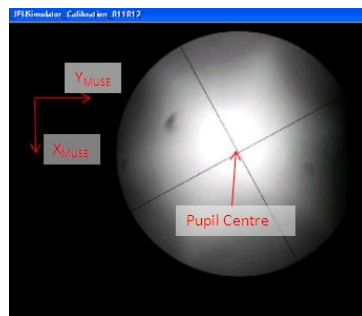

Figure 17: Pupil exposure

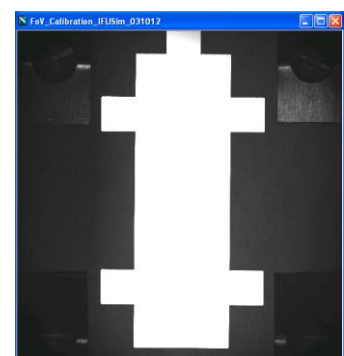

Figure 18: Field exposure

In using IFU Simulator motor controller (§ 3.1.3), the camera objective focus is adjusted until the mask is on focus onto the CCD camera. This position noted “FIELD” onto Motor controller is recorded. This exposure is the reference in positioning for SRO FoV alignment (Figure 18).

5.2 Tests onto IFU Simulator stability at different orientations θ_z

The main error came from the different orientations (θ_z) of the IFU Simulator when it is rotated onto its support. After several iterations, different issues were fixed and the IFU Simulator is now stable.

The IFU Simulator is inserted onto the 24 channels for the integration in Lyon and Telescope. That means it is used at 24 different angles θ_z , from -70.88° up to -31.87° and from 31.87° up to 70.88° . The allocated time to align one channel is 4 hours with 2 persons that means that the IFU Simulator should be a perfect and stable reference. The stability in orientation is tested in both modes: Pupil and FoV. For the pupil test, a collimator lights the IFU Simulator. The IFU Simulator is rotated around z-axis using the tool which allows to insert the IFU Simulator or IFU onto the MUSE Structure (Figure 19). One exposure is recorded each 10° step onto the IFU rotation range. The same test is performed for the FoV stability expect that the collimator is not used and the IFU Simulator mask is recorded.

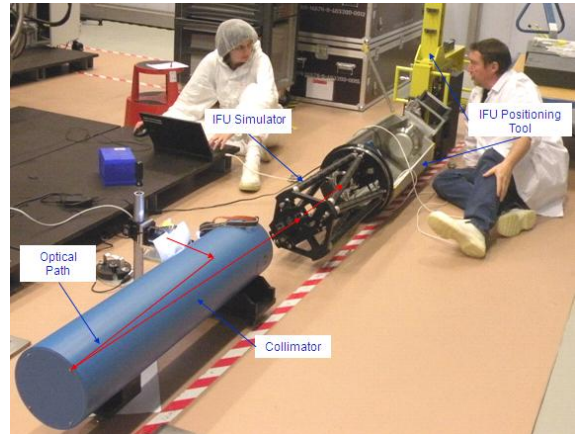

Figure 19: Set up to test the IFU Simulator stability in orientation θ_z

After the IFU Simulator first version, the IFU Simulator was not stable. The maximum deviation in FoV was $\pm 0.3\text{mm}$ in both axes for the position and ± 3 arcmin in tip tilt for orientation. That was 3 times the requirements. For these reasons, the Detection Unit was installed at the level of the IFU Flange by inserted a teleconverter by 2 and directly attached onto the IFU Flange without mechanical interface. That corresponds to the IFU Simulator second version.

With the second version, the IFU Simulator was still unstable with a maximum deviation in FoV of $\pm 0.15\text{mm}$ along x-axis and $\pm 0.05\text{mm}$ along y-axis. The deviation in orientation was lower than ± 1.5 arcmin near the requirement (Figure 20). To solve these issues, the manual shift in focus was replaced by a custom made motorized function. That is the third and last version which is into the requirements. To be sure that the IFU Simulator is stable, before each channel alignment, a calibration in FoV and Pupil is done directly onto MUSE instrument. That gives the Pupil and FoV references for each channel alignment.

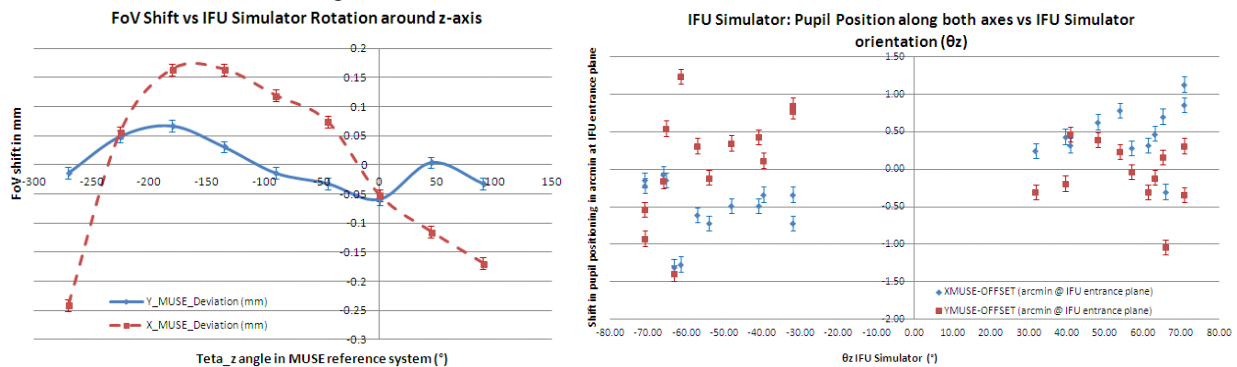

Figure 20: Tests in IFU Simulator rotation around z-axis. Left: FoV shift. Right: Pupil shift

Due to the transport at Paranal, the IFU Simulator was partially dismantled. After its remounting, tests in orientation were done. To avoid any motion of the IFU Simulator in pupil and FoV, all screws should be screwed with a minimal torque of 10N.m. To fix this configuration, all screws were glued with 3M DP110 glue. With that, the IFU Simulator is completely stable ($<\pm 0.01\text{mm}$, $<\pm 0.17\text{arcmin}$). That means, in Paranal, no calibrations were done before to start alignment channel. Time was saving.

6. USE IN MUSE INSTRUMENT

Once the IFU Simulator is aligned and characterized independently using Romer arm measuring device for positioning and autocollimator for orientation, the alignment of each channel could start.

For the alignment, the main constraint is the time. Four hours with 2 persons is dedicated for the alignment of each channel. The alignment consists of: integration of 2 SRO doublets and 2 SRO folding mirrors, insertion of IFU Simulator with the IFU Positioning Tool, SRO Alignment into requirements, SRO performance tests, Dismounting of IFU Simulator.

6.1 Integration of IFU Simulator into MUSE Structure

The IFU Simulator is inserted into MUSE structure with dedicated tool, named IFU Positioning Tool. No alignment is done during insertion. This tool allows to insert each IFU Simulator and IFU at its corresponding z-angle and to insure a perfect positioning ($<30\mu\text{m}$) and orientation ($<30''$) without alignment. This step is duplicated more than 100 times between integration at Lyon and Paranal.

6.2 SRO Alignment using IFU Simulator - [6]

The SRO alignment is done in observing with the IFU-Simulator. To align SRO, a laser diode at 640nm is used onto the MUSE Calibration Unit allowing to align in monochromatic wavelength. Moreover, the laser diode provides a high flux allowing to prealign with eyes ($\pm 0.5\text{mm}$, $\pm 30\text{arcmin}$). The optical beam comes from the real MUSE optical path through MUSE Calibration Unit, Fore Optics and Field Splitter Unit - [2] in order to take into account alignment errors.

The fine adjustment is concentrated on the SRO folding mirrors FM1&2 that will feed each IFU. Fine-adjustment is performed into the relay path by squaring up the FoV and centering the Pupil onto the IFU-simulator with FM1/FM2 (z , θ_x , θ_y) in few iterative processes thanks to IFU Simulator capability. The Figure 21 shows SRO alignment results obtained onto IFU Simulator which are compliant with SRO requirements.

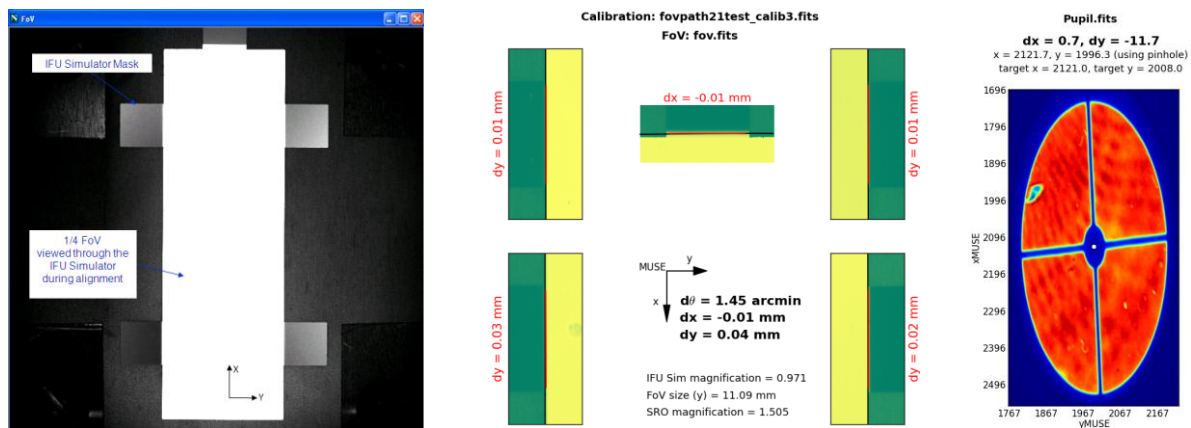

Figure 21 : Example of alignment in FoV and pupil. Left: SRO FOV into IFU Simulator Mask viewed with IFU Simulator. Centre: Dedicated software which computes FoV misalignment in (x, y, θ_z). Right: SRO Pupil Alignment.

6.3 SRO Performance Tests

Using IFU Simulator functionality, the (x, y, θ_z) FoV and (x, y) Pupil of the MUSE 24 channels i.e. coming from [CU+FO+SRO n°i] in WFM&NFM modes are aligned into the requirements. For each channel, image quality of [CU+FO+SRO n°i] in WFM are tested. Moreover, in using the custom made motorized function going from mask plane up to infinity, the 4 planes corresponding to each SRO optical components are recorded. That allows too see any vignetting into all SRO optical component planes.

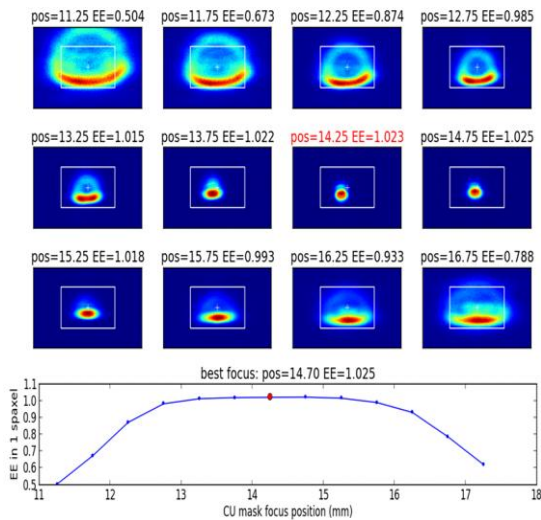

Figure 22 : WFM Image Quality: Focus Curve

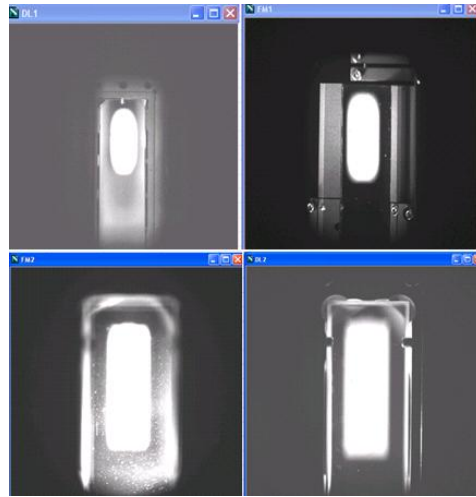

Figure 23 : WFM [CU+FO+SRO n°i] Footprint onto Doublet1, Folding Mirror 1&2, Doublet2

6.4 Alignment validation directly onto IFU

The success of this IFU Simulator alignment approach is demonstrated directly onto each IFU by the correct results for the MUSE positioning and image quality. Each IFU is assembled and tested before to be integrated into the MUSE instrument. To validate independently each IFU, the same tools as IFU Simulator are used. Thanks to this philosophy, no further alignment needs to be done after the IFU is inserted.

The FoV positioning is checked. The Figure 24 presents a raw CCD image of MUSE channel_8 at the best focus. The continuum lamp illuminates across the entire FoV. Forty eight spectra corresponding to 48 mini slits are represented onto the Figure 24. Due to alignment with IFU Simulator, all slits are illuminated. By design, 8 slits should be lower illuminated (between 72 up to 100%) - Figure 25. That is the case for all channel alignments, showing the coherence between IFU Simulator and its corresponding IFU.

The pupil positioning is checked in using the 2nd diffraction order onto MUSE exposures. For that, MUSE is illuminating with an HgCd lamp without filters through pinholes. Only visual inspections onto second diffraction order are performed (Figure 26). No additional vignetting has introduced.

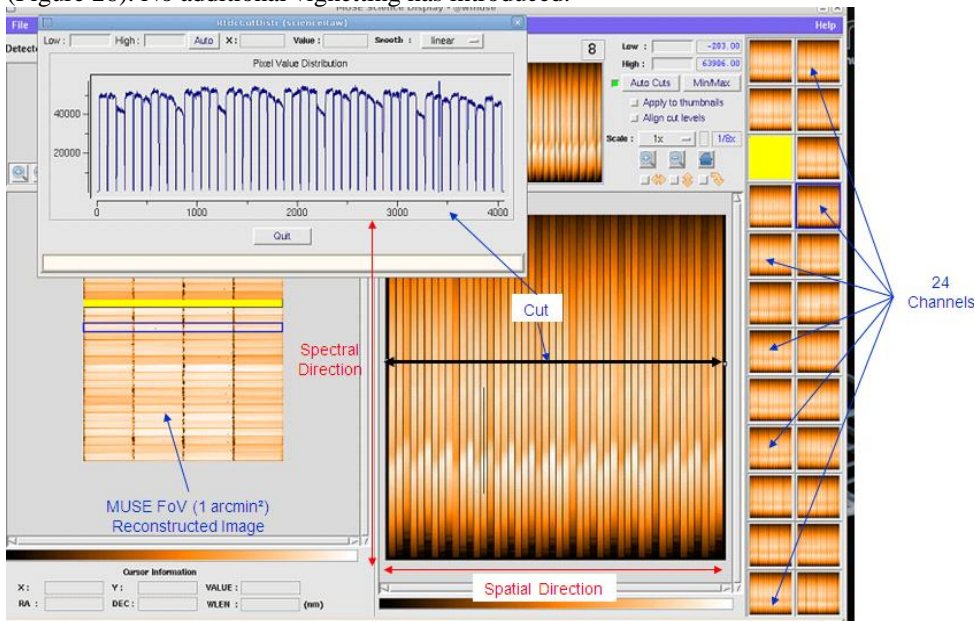

Figure 24: MUSE Continuum flat field exposure of one single channel

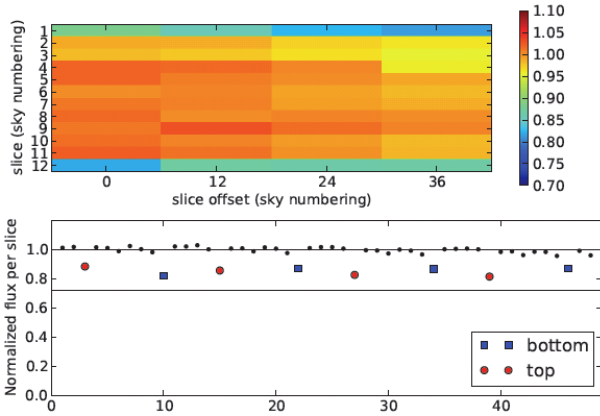

Figure 25: Reconstructed image at IFU entrance plane onto Channel_8

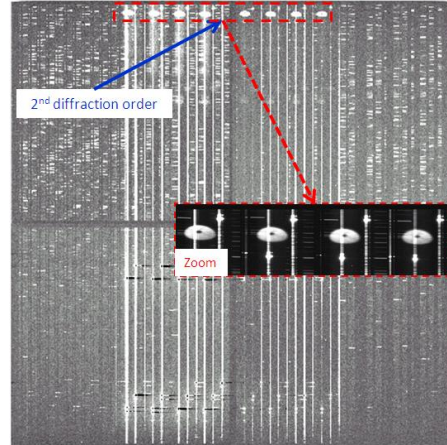

Figure 26: Vignetting Check

7. CONCLUSION

This paper describes the manufacturing, the alignment and tests onto the main alignment and performance tool for MUSE instrument: the IFU Simulator. The IFU Simulator allows to align the 24 channels into MUSE instrument. The tight tolerances and the time allocated for channel alignment (4 hours with 2 persons) was a challenge for the IFU Simulator design. This tool, with an high spatial resolution in pupil and FoV associated with a big optomechahnical stability, allowed to align the 24 channels in record time in same homogeneous performances. Moreover, all channel performances are checked with the same IFU Simulator due to its modularity. This tool could be used to realign a channel after an earthquake or other issues using its fast calibration and its usability. The IFU Simulator consists of the MUSE key tool as the powerful alignment and performance tool for MUSE instrument. The success of this tool is demonstrated by the excellent results obtained during Lyon Preliminary Acceptance (Sept, 13) and during technical and commissioning nights at VLT (Jan, 14) onto MUSE positioning, image quality and throughput directly onto the sky.

ACKNOWLEDGMENT

We thank all the member of the MUSE team of this ESO international project at CRAL/Lyon, IRAP/Toulouse, IAG/Göttingen, AIP/Potsdam, Leiden Obs, ETH/Zürich and ESO/Garching for their invaluable contribution. This work was strongly supported by MUSE management and technical teams. We thank especially ESO, CNRS/INSU and University Claude-Bernard Lyon I for their strong support to the MUSE project.

REFERENCES

- [1] Bacon R. et al., "Highlights from the Multi unit Spectroscopic Explorer (MUSE), a 2nd generation VLT instrument for the VLT," Proc SPIE 9147, 506 (2014)
- [2] Laurent F. et al., "MUSE Field Splitter Unit: fan-shaped separator for 24 integral field units," Proc. SPIE 9151, 64 (2014)
- [3] Caillier P. et al, "MUSE instrument performance through time from design to the sky," Proc SPIE 9147, 224 (2014)
- [4] Richard J. et al., "VLT/MUSE global performances as measured during commissioning," Proc. SPIE 9147, 113 (2014)
- [5] Renault E. et al., "Optomechanical system of AIT tools to perform tests and integrations of 24 IFU," Proc. SPIE 7739, 124 (2010)
- [6] Laurent F. et al., "MUSE optical alignment procedure," Proc SPIE 8446, 226 (2012)