



**HAL**  
open science

## Technical Report on Selective Laser Ionization

Anne Piscitelli

► **To cite this version:**

Anne Piscitelli. Technical Report on Selective Laser Ionization. CNRS -SUBATECH. 2023. hal-04783410

**HAL Id: hal-04783410**

**<https://hal.science/hal-04783410v1>**

Submitted on 14 Nov 2024

**HAL** is a multi-disciplinary open access archive for the deposit and dissemination of scientific research documents, whether they are published or not. The documents may come from teaching and research institutions in France or abroad, or from public or private research centers.

L'archive ouverte pluridisciplinaire **HAL**, est destinée au dépôt et à la diffusion de documents scientifiques de niveau recherche, publiés ou non, émanant des établissements d'enseignement et de recherche français ou étrangers, des laboratoires publics ou privés.



<b>Title</b>	Technical Report on Selective Laser Ionization
<b>Internal Ref.</b>	SMI-RT01-2023
<b>Summary</b>	This document presents the technical requirements and the devices considered for the selective laser ionization device of the SMILES project.

<b>Document Drafters</b> : Anne Piscitelli Anne.piscitelli@subatech.in2p3.fr	<b>Laboratory</b> : SUBATECH <b>Project</b> : SMILES
---	---

<b>Document Proofreaders</b>	<b>Date and signature</b>	
Nathalie Michel	08/02/2023	NM
Vincent Métivier	14/02/2023	VM

---

## Table of contents

---

<b>1</b>	<b>CONFIGURATION OF THE SELECTIVE IONIZATION SYSTEM.....</b>	<b>5</b>
<b>2</b>	<b>ND:YAG PUMP LASER.....</b>	<b>6</b>
<b>3</b>	<b>BROAD-BAND CAVITY: TI:SAPPHIRE LASERS.....</b>	<b>7</b>
3.1	SCHEMATIC DIAGRAMS OF CAVITIES.....	8
3.2	“BFR” CAVITY.....	8
3.3	“GRATING” CAVITY.....	9
3.4	OPTICAL ELEMENTS.....	9
3.4.1	<i>Mirrors for pump laser (M1 and M2).....</i>	<i>9</i>
3.4.2	<i>Focusing lens in Ti:Sa crystal (L).....</i>	<i>9</i>
3.4.3	<i>Ti:Sapphire crystal rod (Ti:Sa).....</i>	<i>10</i>
3.4.4	<i>Mirrors composing the resonant cavity.....</i>	<i>10</i>
3.4.4.1	<i>Curved mirrors or “Short-Wave Pass” (SWP1 and SWP2).....</i>	<i>10</i>
3.4.4.2	<i>End mirror (HR).....</i>	<i>10</i>
3.4.4.3	<i>“Output coupler” mirror (OC).....</i>	<i>10</i>
3.4.5	<i>Birefringent filter (BRF).....</i>	<i>11</i>
3.4.6	<i>Etalon (E).....</i>	<i>11</i>
3.4.7	<i>Grating.....</i>	<i>11</i>
3.4.8	<i>Beam expansion.....</i>	<i>12</i>
<b>4</b>	<b>HIGH HARMONIC FREQUENCY GENERATION.....</b>	<b>12</b>
4.1	SECOND HARMONIC GENERATION (SHG).....	13
4.2	THIRD HARMONIC GENERATION (THG).....	13
4.3	FOURTH HARMONIC GENERATION (FHG).....	14
<b>5</b>	<b>LASER MONITORING AND CONTROL SYSTEM.....</b>	<b>14</b>
5.1	LASER BEAM DIAGNOSIS.....	15
5.1.1	<i>Power measurement.....</i>	<i>15</i>
5.1.2	<i>Wavelength measurement.....</i>	<i>15</i>
5.1.3	<i>Beam visualization.....</i>	<i>15</i>
5.2	TEMPORAL OVERLAP.....	16
5.3	CONTROL, SYNCHRONIZATION AND DATA ACQUISITION.....	16
5.4	COOLING OF THE TI:SA CRYSTAL.....	17
<b>6</b>	<b>OPTICAL PATHS.....</b>	<b>17</b>
6.1	OPTICAL PATH ①: BEFORE THE TI:SA CAVITIES.....	18

6.2	OPTICAL PATH ②: FROM THE OUTPUT OF THE Ti:SA CAVITY TO THE SELECTED WAVELENGTH FOR SELECTIVE IONIZATION. ....	18
6.3	OPTICAL PATH ③: FROM THE SELECTED WAVELENGTH FOR SELECTIVE IONIZATION TO THE ION SOURCE.....	19
6.3.1	<i>Spatial overlap.</i> .....	20
6.3.2	<i>Transport to the ion source.</i> .....	21
6.4	OPTICAL PATH ④: FOR BEAM DIAGNOSIS. ....	22
<b>7</b>	<b>MAIN TECHNICAL CHARACTERISTICS OF THE "LASER ROOM".....</b>	<b>23</b>
<b>8</b>	<b>CONCLUSIONS AND QUESTIONS TO THE EXPERT'S COMMITTEE.....</b>	<b>24</b>
<b>9</b>	<b>BIBLIOGRAPHY.....</b>	<b>27</b>
<b>10</b>	<b>LISTING OF FIGURES .....</b>	<b>28</b>
<b>11</b>	<b>LISTING OF TABLES.....</b>	<b>29</b>

The SMILES project (Mass Separation Coupled with Laser Ionization for Environmental and Health Applications) aims to quantify, purify or separate isotopes for health and environmental applications using the laser ionization technique coupled with mass separation.

This report focuses specifically on laser beam resonant ionization which was first demonstrated and experimented at the LNPI (Leningrad Nuclear Physics Institute) in 1988 and which selectively and efficiently promotes atoms into their excited and ionized states by photoionization.

We are particularly interested in the performance that instruments, using this technique, can achieve:

- A high selectivity: isobaric deletions are greater than  $10^8$ , only due to multi-step optical transitions, and greater than  $> 10^{13}$  by combining laser ionization with mass separation. Indeed, laser ionization is selective according to the atomic number  $Z$  while the application of an electromagnetic field ensures the separation of the isotopes according to their mass  $A$ , the combination of the two thus making it possible to isolate a given isotope ( $Z, A$ ) with great precision.
- An ionization efficiency between  $10^{-3}$  and  $10^{-1}$  that is due to the high optical cross-section values that generate high ionization and excitation probabilities.
- A high sensitivity that can reach detection limits of fg, and even ag.

For the SMILES project, the experimental set-up, as a whole, will have to adapt to the diversity of samples encountered within a large community of users in various disciplinary fields (environment, medicine, physics, chemistry...). The experiments planned will first concern the analysis of stable isotopes or very low activities radioisotopes at the ultra-trace scale. A first list of elements of interest has already been established: Stable Cu-(63/65), Er, Pb, Am, Pu, Ra-226/Ra-228 (but also interest in a Ra-228 source), Pb-210, Th-230, U-236,...

The primary aim of this report is to define the technical requirements for the selective laser ionization device of the SMILES project by presenting initial specifications of the selective laser ionization system as it will be implemented.

After presenting two possible configurations of the experimental set-up, the various elements of this system will be reviewed: pump laser, Ti:Sapphire cavities, frequency conversion units, optical paths, system control such as laser diagnostics, spatial and temporal overlapping of laser pulses,... as well as the main technical characteristics of the future "Laser room".

Finally, a series of "open questions" is addressed to the expert committee in order to validate and improve the technical solutions to be implemented for the SMILES selective laser ionization system.

# 1 Configuration of the selective ionization system.

Different configurations for the SMILES selective ionization system are possible: two examples of schematic diagrams are given below (Figure 1 and Figure 2). They present an overview of the system and the different constituent parts.

The six main parts of the selective ionization device to be set up in the Subtech laboratory, which will be detailed in the rest of this report, are:

- ① Pump laser
- ② Ti:Sapphire cavities
- ③ High harmonic frequency generation (doubling, tripling or quadrupling)
- ④ Optical paths (between the different elements on the optical table)
- ⑤ Diagnosis of laser beams (power, wavelength)
- ⑥ System control

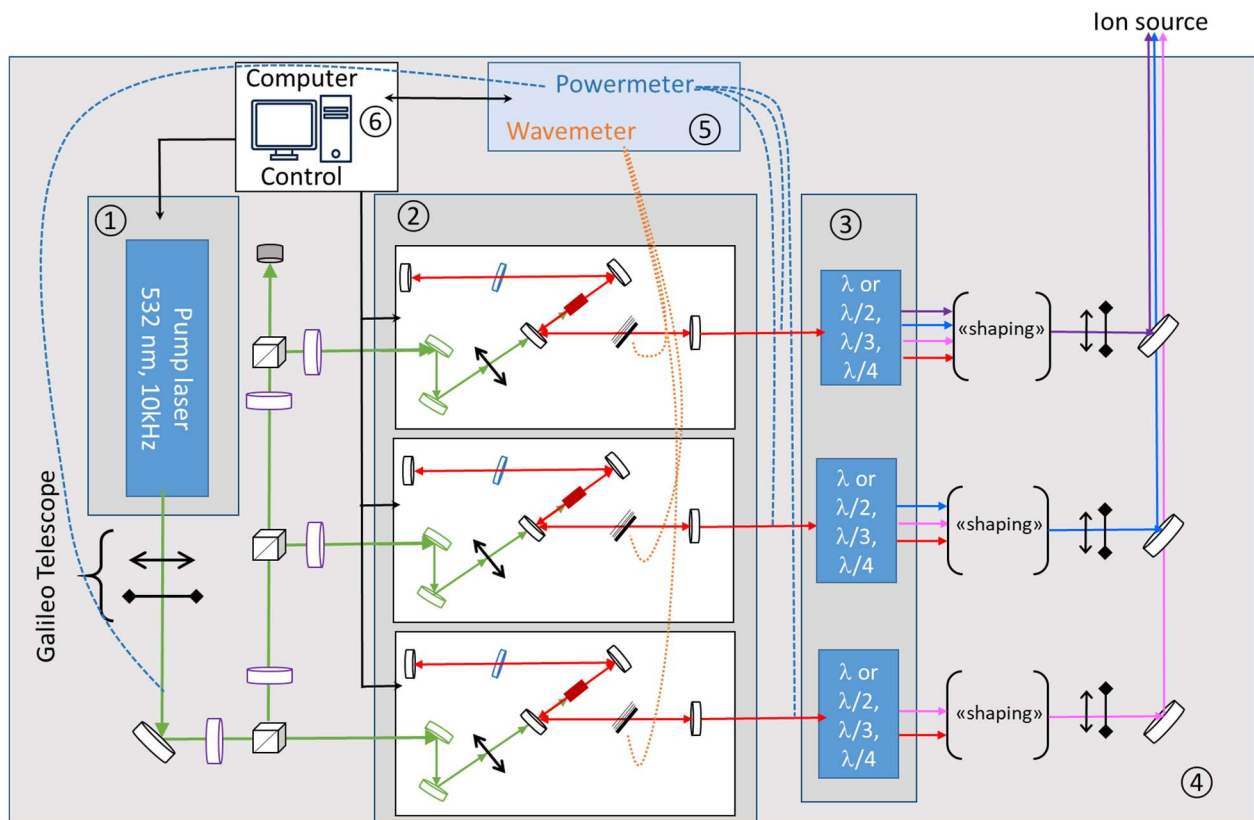
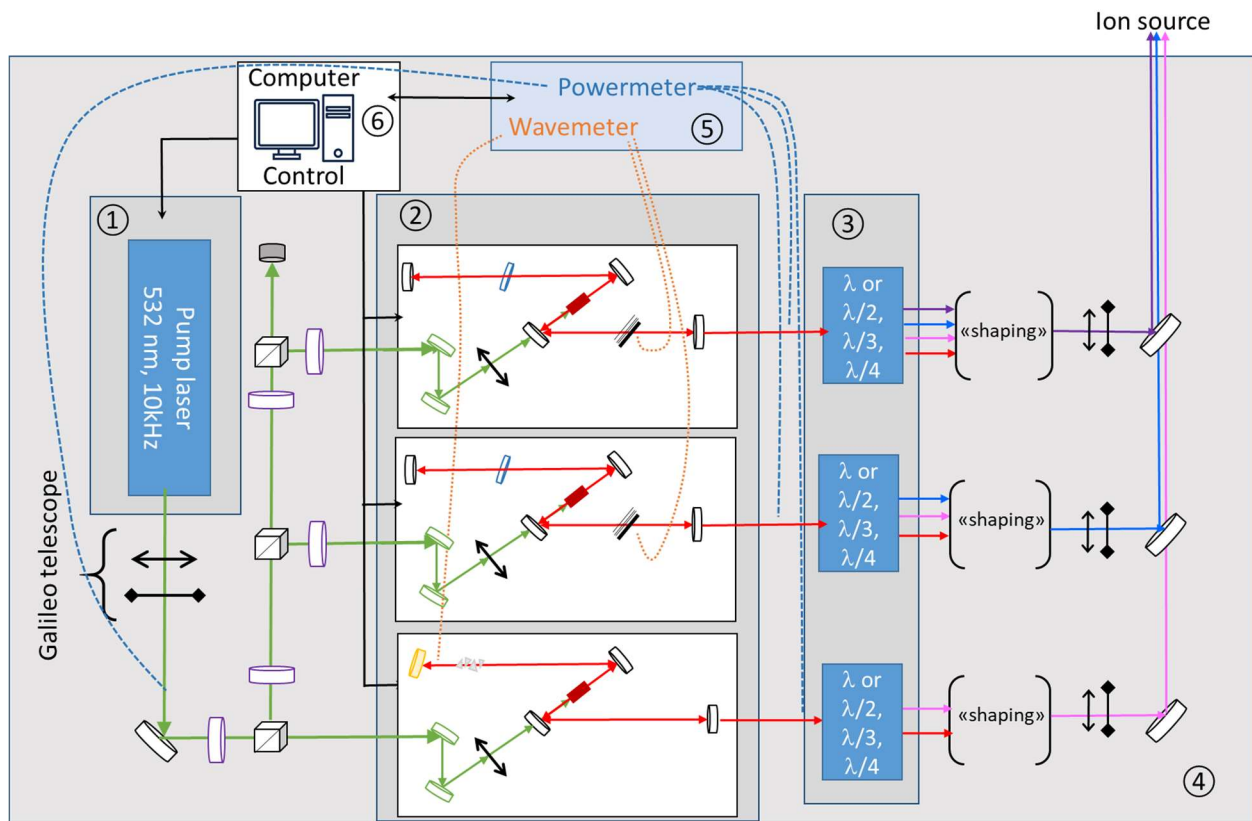

Figure 1. Schematic diagram with three “BRF” cavities.



**Figure 2.** Schematic diagram with two “BRF” cavities and a “Grating” one.

Note: The document “Technical Report on Selective Laser Ionization - Appendix” give a first list of suppliers and materials (references, prices and technical specifications ) for optical components, optomechanics and system control.

## 2 Nd:YAG pump laser.

The role of the Nd:YAG laser is to induce the optical pumping of the Ti:Sa cavities (cf. § 3).

Typically, it’s a frequency-doubled Nd:YAG to provide a 532nm laser beam, with a high working frequency (at least 10 kHz) and with a minimum average output power of 60 W. It must also have a very good stability in time, pulse energy and optical properties as well as a low divergence.

The main technical characteristics required are therefore the following [5] [6]:

- Wavelength: 532nm
- Working frequency: minimum 10 kHz
- Pulse length: minimum 100ns (width at half height)
- Average output power @ 10 kHz: at least 60W. This power must be sufficient for the pump laser to pump several laser cavities (with water-cooled Ti:Sa crystals) at the same time
- Energy per pulse @ 10kHz: minimum 6 mJ
- Energy stability: < 2% rms
- Long term stability: < 1,5% rms
- Positional stability: < 25μrad rms
- Output beam divergence: < 7mrad
- Beam quality factor:  $M^2 < 25$
- Beam profile: Gaussian, circularity > 85

- Output beam diameter: ~3-4mm at half height
- Linear polarization 100 : 1
- Laser component cooling system without microchannels
- Humidity control system in the laser head
- TTL compatible external trigger input
- TTL output synchronized to laser rate

Note: The previous requirements are for the laser but the complete system will also include the cooling unit (usually water), the power supply and control unit and the control system.

Pump lasers with appropriate specifications are commercially available. An example is the MESA™ from Amplitude (purchased by GANIL) which some dimensions are given below:

- Laser head: 68.6 × 17.1 × 14.5 cm (L × l × H) - 20.4 kg
- Power supply: 50.9 × 48.3 × 17.7 cm (L × l × H) - 17.7 kg
- Chiller: 69.9 × 48.3 × 41.1 cm (L × l × H) - 55 kg

The MESA's unit price (Nov. 2022 quote) is 74950 euros HT, with delivery and installation but without the long cable option. The « long cable » option, taken at GANIL, corresponds to a 7 m long cable, between the laser head and its power supply, instead of 3.5 m that is the standard length.

Note: Unit price of the « long cable » (in 2020): 3500 €; for information, price of the MESA in 2020: 62090 €.

### 3 Broad-band cavity: Ti:Sapphire lasers.

The selective ionization laser system for the SMILES project will consist of a set of two or three tunable lasers (i.e. 2 or 3 Ti:Sapphire cavities): two birefringent filter (BRF) cavities and, if possible, a third cavity: BRF or Grating.

Ti:Sapphire cavities are laser cavities that will allow the selective ionization of atoms by subjecting them to different wavelengths determined according to the ionization patterns of the elements of interest (a cavity = a specific wavelength = a specific energy jump).

They all have the same primary emission spectrum which is provided by a resonant cavity (or optical resonator) in Z configuration with a solid gain material (Ti:Sa crystal rod) as the light amplifying medium and the Nd:YAG laser mentioned above as the optical pumping system.

The selection of the wavelengths is then done by means of configurations differing from one another by the characteristics of the optics and the elements of adjustment present inside the resonant cavity:

- The "BRF" cavity, composed of a birefringent filter (BRF) & etalon filter (E),
- The "Grating" cavity, composed of a grating and a beam expander (set of 4 prisms).

The schematic diagrams of these cavities are presented in the next paragraph, then, in a second one, each optical element will be taken up in order to detail more precisely its functions.



### 3.1 Schematic diagrams of cavities.

On the following figures are represented [1] [2]:

- In green, the pump laser path:

The pump laser (cf. § 2) will be used to excite the active medium of the cavities by optical pumping of the Ti:Sa rod. This is the pumping mode of solid-state lasers. The beam of the pump laser enters the cavity and is directed with the help of two mirrors (M1 and M2) on a convergent lens (L). It's thus focused in the light amplifying medium (i.e. Ti:Sa crystal) through the latter. It's generally sent on the back face of the Ti:Sa rod in order to allow a better laser pumping without damaging the crystal.

- In red, the optical path in the resonant cavity:

The cavity provides a feedback function through which the overall device becomes an oscillator: it is composed of different mirrors that allow the light to pass many times through the amplifying medium in order to obtain the population inversion necessary for the emission of a laser beam. Thus, two (at least) to several mirrors allow selecting and confining the light produced in a chosen direction. The two mirrors at the end of the resonator are, for one, totally reflecting and, for the other, partially reflecting, in order to let the useful part of the laser radiation pass towards the outside.

In our case, our optical resonator consists of a Z-cavity with four mirrors with a Ti:Sa rod (amplifying medium), two curved mirrors (SWP), a highly reflective mirror (HR) for the "end" of the optical resonator and an "output coupler" mirror (OC) at the laser beam output.

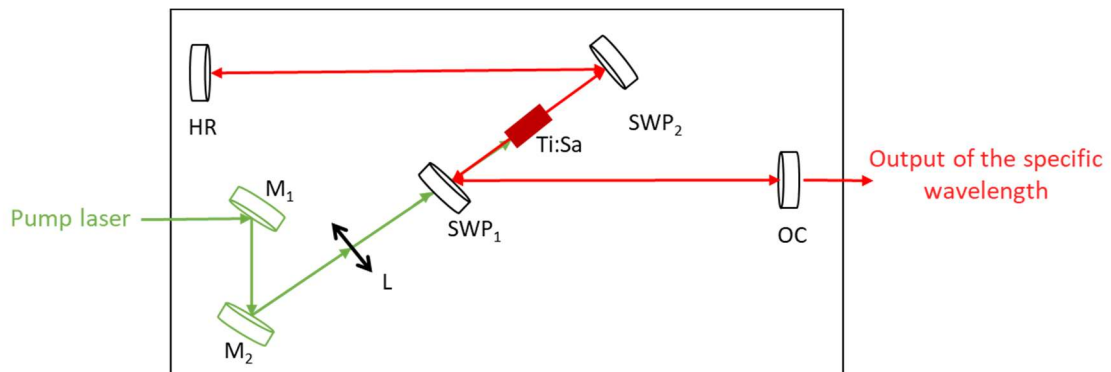

**Figure 3.** Schematic diagram of the cavity without wavelength selection systems.

### 3.2 "BFR" cavity.

It includes a birefringent filter (BRF) and etalon(s) (E).

The birefringent filter is placed on the beam exit line between the first curved mirror (SWP1) and the output coupler (OC). The etalon(s) are positioned between the second curved mirror (SWP2) and the end mirror (HR).

The use of etalons is to refine the selection of the wavelength.

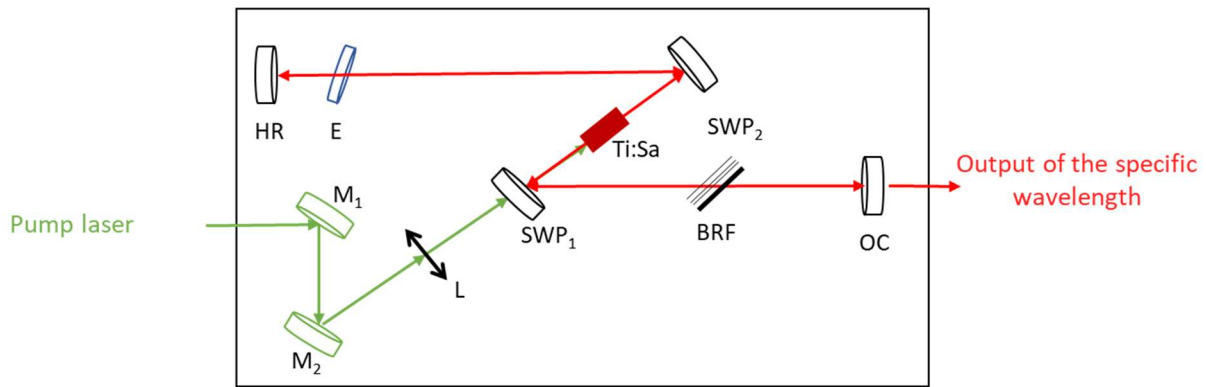

**Figure 4.** Schematic diagram of the “BRF” cavity.

Note: This system could be coupled if necessary to a Pockels cell (PC) for time overlap.

### 3.3 “Grating” cavity.

The “Grating” cavity was developed to allow a continuous wavelength scan over a large range in order to work, for example, on ionization patterns. In this case, a grating replaces the birefringent filter and the etalon for the wavelength selection.

The grating is positioned in place of the resonator end mirror (HR). Furthermore, between the grating and the second curved mirror (SWP2), there is a laser beam expander that is made from a set of four prisms. These prisms are used to increase the size of the laser beam on the grating and thus, increase the spectral selectivity of the system and avoid damages on the sensitive grating surface.

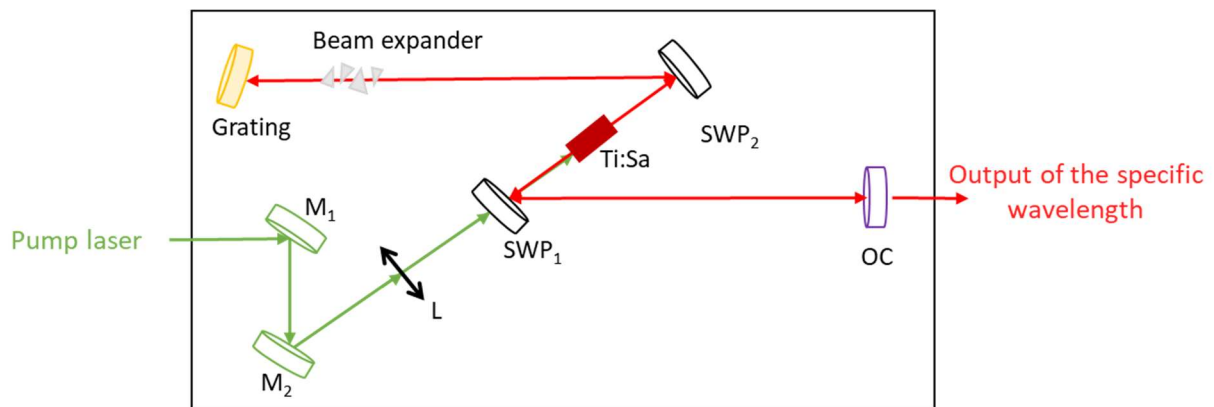

**Figure 5.** Schematic diagram of the “Grating” cavity.

### 3.4 Optical elements.

In this paragraph, each component from Figure 3, Figure 4 and Figure 5 are described individually.

#### 3.4.1 Mirrors for pump laser (M1 and M2).

These are mirrors for Nd:YAG laser (at 532 nm), with high energy damage threshold. They are used to direct the pump laser beam into the Ti:Sa cavity.

#### 3.4.2 Focusing lens in Ti:Sa crystal (L).

It's a convex plane lens that is used to focus the pump laser beam in the Ti:Sa crystal rod.

### 3.4.3 Ti:Sapphire crystal rod (Ti:Sa).

The amplifying medium of the laser cavity is therefore a Ti:Sa rod.

These crystals absorb light between 400nm and 640nm and emit over a wide emission range from 660nm to 1050nm, with a central emission around 800nm. Ti:Sa laser systems are reliable, easy to handle and (almost) maintenance-free. They can generate ultra-short pulses, have a high damage threshold and excellent thermal conductivity, which allows to mitigate thermal effects even at high laser powers.

Moreover, for a pumping power at the input of the crystal between 8 and 15 W, they can provide output powers up to 5W (for the fundamental wavelength), frequencies up to 10 KHz for pulse duration of 30-60ns (fwhm) [1] [3] [4]. It should be noted that the power delivered at the output is strongly dependent on the chosen wavelength and the set of mirrors forming the resonant cavity.

### 3.4.4 Mirrors composing the resonant cavity.

As a reminder, the four mirrors that make up the resonant laser cavity are two curved mirrors (SWP1 and SWP2), an end mirror (HR) and an output mirror (OC).

So, depending on the desired wavelength, it is necessary to have an appropriate set of mirrors for the cavity. Indeed, each mirror must have a surface coating adapted to this wavelength. Thus, four sets of mirrors are needed to cover four different wavelength ranges that are the following:

- 655 nm - 755 nm,
- 750 nm - 850 nm,
- 840 nm - 940 nm,
- 900 nm - 1050 nm.

It should be noted that for the cavity's configuration "Grating", there is another set that allows access to a wide range of lengths: 650 nm - 1050 nm. The output coupler of this last set can also be used with the other configurations to modify the wavelengths produced.

#### 3.4.4.1 Curved mirrors or "Short-Wave Pass" (SWP1 and SWP2).

The Ti:Sa crystal is surrounded by two first curved concave mirrors (SWP1 and SWP2) also called Short-Wave Pass. They owe this name to the fact that they transmit in short wavelength ranges (up to the pumping range of 532 nm) and have a high reflection in longer wavelength ranges. (output Ti:Sa characteristic: 650 nm to 1050 nm).

Despite the fact that the Ti:Sa rod is cut at the Brewster angle, the angle of incidence still produces astigmatism and leads to a resulting laser beam with an elliptical profile. To remedy this, the mirrors are tilted at a chosen angle of 18.1° with respect to the laser beam axis [1].

#### 3.4.4.2 End mirror (HR).

This is the resonant cavity end mirror (so-called "end mirror"), so it is essential that its reflectivity is high (~ 99.9%), whatever the wavelength of the beam.

#### 3.4.4.3 "Output coupler" mirror (OC).

In general, the output couplers are partially transparent mirrors, used to extract the output beams of the laser resonators. In our case, their reflectivity will be between 70% and 80% depending on the desired wavelength. It should be noted that to avoid any uncontrolled optical feedback in the cavity (i.e. from retro-reflections), there is an angle between the two faces of the output coupler between

0.5° and 1°. In addition, the output surface is also coated with an anti-reflection coating to minimize the Fresnel reflection losses when the laser beam exits the holder [3].

#### 3.4.5 Birefringent filter (BRF).

Combinations of two or three blades of different thicknesses are used as filters in tunable lasers, such as Ti:Sa, to select the emission wavelength: this is called Lyot filter or birefringent filter. This optical filter, made of a crystalline quartz, has a refractive index that depends on the polarization and direction of propagation of light. These physical properties will be used in the intra-cavity laser to adjust and reduce the bandwidth of the output wavelength [3], which is about 330 GHz for Ti:Sa in its “original” state. Thus, when the BRF rotates around the axis perpendicular to the blade surface, the transmission curve can then be shifted.

The Lyot filters (or BRF) used in Ti:Sa cavities for selective ionization are three quartz plates.

Note: Many laboratories use a multi-plate filter to have an increased spectral range, as the frequency tuning capabilities are finer than a single thick filter.

#### 3.4.6 Etalon (E).

The etalon or etalon filter (also called Fabry-Perot interferometer) consists of one or more parallel reflecting plates separated by a fixed distance, the light entering the etalon undergoes multiple reflections and the interference of the light leaving the etalon at each rebound causes a modulation of the transmitted and reflected beams. The transmission spectrum will depend on these resonances. In this way, certain wavelengths will be selected according to the parameters of the interferometer [1].

The BRF therefore already allows to adjust and reduce the bandwidth of the output wavelength, but the addition of a thin etalon will allow to select even less longitudinal laser modes and thus to narrow even more this bandwidth. However, it is important to note that the multiple reflections on the surfaces of the etalon introduce a loss at each round trip in the resonator and thus decreases the output power. To further reduce the bandwidth (thus eliminating even more longitudinal modes), another thicker etalon can be added. Indeed, because of its greater thickness, it has a smaller free spectral range and the selection of the final wavelength will be better. However, the addition of this second etalon will add even more losses to the round trip of the resonator, and its frequency adjustment is more delicate.

Examples of results obtained with a configuration of one or two etalons:

- 1 thin etalon (0.2 or 0.3 mm): generation of a bandwidth of about 3-5 GHz [1] (The reflectivity of the resonator is then between 15% and 35% [4])
- 1 thin etalon (0.2mm) and 1 thick etalon (6mm): generation of a bandwidth of about 1 GHz [3].

Note: the higher the reflectivity of the etalon, the greater the losses in the resonant cavity.

#### 3.4.7 Grating.

The (diffraction) gratings are optical components that have the property of reflecting or transmitting incident light in specific directions in space: these directions depend on the wavelength. Thus, if a beam containing several frequencies illuminates a network under a given incidence, the different frequencies will be reflected or transmitted with different angles.

Moreover, under a so-called Littrow incidence ( $\theta_L$ ), the diffraction angle  $\theta_m$ , in reflection or transmission, is opposite to the angle of incidence:  $\theta_i = \theta_L = -\theta_m$ . In other words, the reflected beam in Littrow incidence goes back in the direction of the light source. Thus, by playing with the grating tilt,

this configuration allows to select the wavelength returned to the cavity and to scan a wide range of wavelengths continuously.

In the Ti:Sa cavity, this grating, placed at the end of the laser cavity, replaces the birefringent filter and the etalon for wavelength selection. A spectral linewidth of 2-3 Ghz was achieved with a grating of 1740 lines/mm and a gold coating [3].

#### 3.4.8 Beam expansion.

The purpose of the beam expander is to enlarge the laser beam.

It is located in front of the grating and consists of four anti-reflective coated prisms. As the laser beam passes through it, it is enlarged in the horizontal direction, resulting in a higher number of illuminated grooves and increasing spectral selectivity of the grating.

Another advantage is that it reduces the laser intensity on the grating surface and thus increase the protection from laser damage.

At GANIL, three different sets are used for three different expansion ratios: 9x, 12x and 17x. It should be noted that the most recent designs use much smaller prisms to reduce the size of the resonator to a minimum [4].

## 4 High harmonic frequency generation.

The accessible wavelengths with these Ti:Sa laser cavities are around 700 to 950 nm for the fundamental radiation. This leads to a limitation for resonant photoexcitation that is the inaccessibility of high energy transitions. However, almost all elements have strong atomic transitions from 2.5 to 6 eV. This imposes the necessity to work with shorter wavelengths (up to the UV) than those of the fundamental. Therefore, to extend the range of wavelengths from the fundamental, the generation of high harmonics is necessary and will be produced by the interaction of incident laser radiation with a non-linear optical medium (for example, a BBO crystal:  $\beta$ -baryum borate). In these Ti:Sa lasers, this second harmonic generation process is called "oo-e": two ordinary polarized (p-) fundamental photons will produce an extraordinary polarized (s-) doubled photon. The production of a new photon can only take place if the two incident photons used have the same polarization, and this is true for all schemes involving photon summation and/or subtraction processes in non-linear media.

Thus, by this method, the fundamental frequency of the Ti:Sa laser beam can be doubled, tripled and quadrupled. The wavelengths then accessible are approximately 350 to 475 nm for the second harmonic generation (SGH), 233 to 317 nm for the third harmonic generation (TGH), and 210 to 237 nm for the fourth harmonic generation (FGH). Wavelengths below 210 nm suffer from ultraviolet absorption when propagating through the air [1] [3].

Frequency doubling can be done in intra or extra-cavity Ti:Sa, the generation principle always being the same. However, even if the intra-cavity doubling has advantages because its doubling efficiency is much higher than in extra-cavity, which leads to a much higher output power, the alignment procedure is more difficult.

To simplify the intra-cavity Ti:Sa settings, we will start with an off-cavity frequency doubling, tripling and quadrupling system which will therefore include:

- A doubling system (SGH),
- A tripling system (TGH),
- A quadrupling system (FGH).

#### 4.1 Second Harmonic Generation (SHG).

Second harmonic generation is therefore a nonlinear optical process in which two photons of the same frequency interacting with a nonlinear material, are “combined” and generate a new photon with twice the energy of the initial photons and, consequently, with twice the frequency or half the wavelength of the initial photons. Thus, as soon as the beam of the Ti:Sa fundamental is guided in the doubling crystal (BBO, for example), the output of a frequency doubled beam can be effective.

The beam emerging from the cavity is focused through a plano-convex lens on a doubling crystal and a doubled beam is emitted at the output (cf. Figure 6).

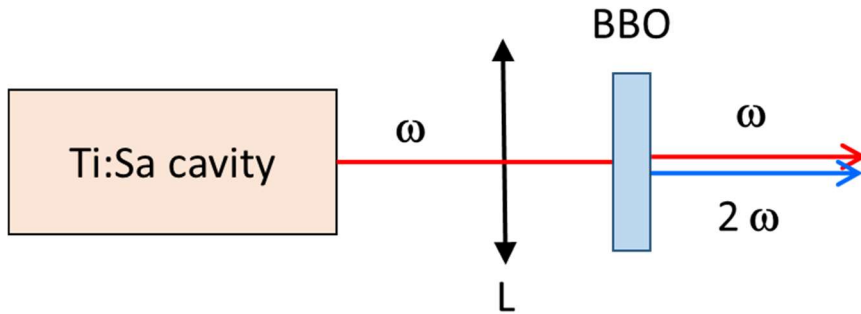
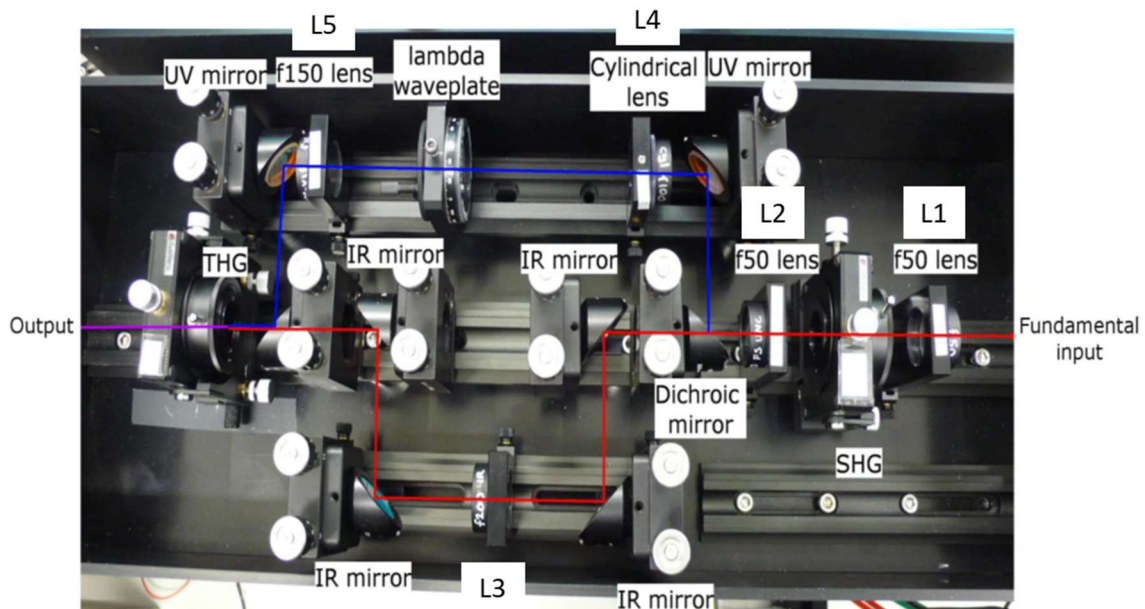

**Figure 6.** Second harmonic generation in extra-cavity Ti:Sa.

#### 4.2 Third Harmonic Generation (THG).

For third harmonic generation, it is necessary to combine the first and second harmonics in a doubling crystal. The necessary configuration is more complex than for doubling and can only be done extra-cavity Ti:Sa.

A typical frequency conversion unit (for the third harmonic generation) is visible on the Figure 7.



**Figure 7.** Frequency conversion unit for third harmonic generation [1].

The fundamental laser radiation is focused through a first plano-convex lens (L1) into the nonlinear BBO crystal (SHG) which allows generating the second harmonic with a typical efficiency value of 25% of the input laser power.

At the output of the BBO, a second plane-convex lens (L2) is used to shape the two laser beams: the frequency-doubled laser beam (in the « blue ») and the fundamental laser (in the IR). They are then separated by a dichroic mirror and follow two different optical paths:

- Path for the “IR” beam: a plane-convex lens (L3) allows focusing it in a second BBO crystal (TGH).
- Path for the “blue” beam : it passes through a first cylindrical plano-convex lens (L4) for shaping, then through a half-wave plate (to "tune" its polarization to that of the IR beam) and, finally, a last plano-convex lens (L5) allows to focus it in the second BBO crystal (TGH).

Thus, the two beams are recombined in the BBO crystal (TGH) to generate the third harmonic, which provides an efficiency of about 10% of the input power.

### 4.3 Fourth Harmonic Generation (FHG).

The generation of the fourth harmonic will be done by combining two second harmonic photons in a doubling crystal. In other words, quadrupling is possible by adding a second doubling stage to the second harmonic beam.

This quadrupling process will be much less efficient than the previous ones (doubling and tripling). The expected efficiency is about 2% of the initial power of the laser beam.

A plano-convex lens is used to focus the beam in a first doubler crystal to generate the second harmonic. The emerging beams are then separated with a dichroic mirror to keep only the second harmonic. This one is then focused, with a second plano-convex lens, in the second doubler crystal to generate the fourth harmonic (cf. Figure 8).

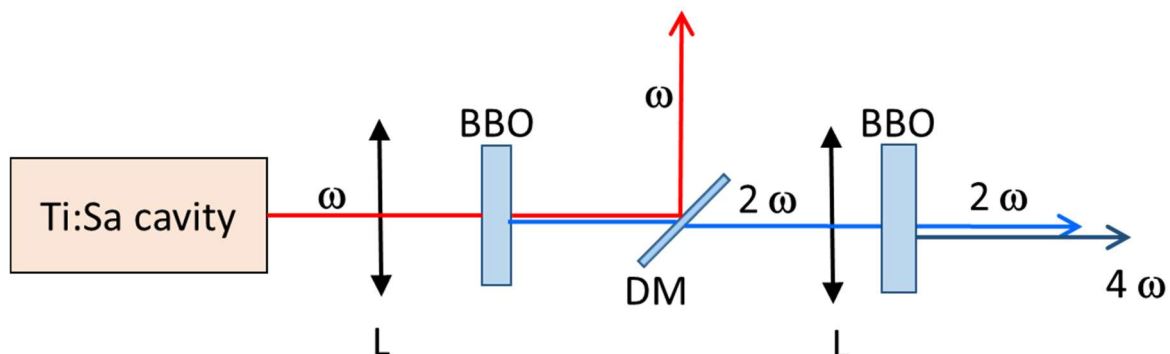

**Figure 8.** A two steps fourth harmonic's generation.

## 5 Laser monitoring and control system.

In the laser room, several kinds of controls are necessary for the proper functioning of the system:

- Laser beam diagnostics: power control, wavelength control, beam visualization (e.g. to control the spatial overlap of the beams before transport to the ion source, to monitor the quality of the various beams,...)
- The temporal overlap of the laser beams leaving the Ti:Sa cavities (i.e. the synchronization of the Ti:Sa cavities)
- Control and synchronization of the entire system and data acquisition.

## 5.1 Laser beam diagnosis.

It is essential to characterize the different laser beams present in the laser room in terms of:

- Power, with powermeters
- Wavelength, with lambdameters
- Visualization of laser beams

### 5.1.1 Power measurement.

The power of the pump laser is measured before and after each experiment to check its long-term power stability, with a maximum power probe range of 100 W.

The power of the Ti:Sa laser cavities is measured over a maximum range of 10 W : the powermeter is used to read the output power and maximize it by adjusting the various components of the cavity [1].

### 5.1.2 Wavelength measurement.

Lambdameters provide informations on the spectral bandwidth and wavelength. The measurement is generally done from the wavelength of the fundamental from Ti:Sa cavity (cf. § 6.4).

Note: Ideally, lambdameter must be re-calibrated at each start-up. For this, a reference light source with a narrow linewidth (e.g. He-Ne laser) is used. The He-Ne beam is simply sent to the lambdameter using the same fiber as the one used for the laser beams coming from the Ti:Sa cavity. Another way to calibrate the device is to use a fluorescent signal from Cs, Rb, K cells excited by an LED source.

### 5.1.3 Beam visualization.

The visualization of the beams is necessary for the control of the spatial overlapping of the beams before transport to the ion source and for the monitoring of the quality of the various beams. This can be done by mean of a CCD camera, by visualization on a screen or by other existing means of spatial diagnosis for the lasers.

Two examples of interest are the following:

- Visual inspection of the beam at the Ti:Sa cavity exit through a divergent lens to ensure the quality of the Gaussian mode. This operation also allows optimizing the resonator with the mirror of the output coupler.
- It would be interesting to develop for SMILES the same system of control and optimization of the spatial overlap and spot size of the laser beams inside the ion source (see. Figure 9), as implemented at GANIL [1]. For this purpose, before leaving the laser room, a small fraction of the beams is diverted to an alternative optical path either to a viewing screen or to a diffraction grating. The purpose of this alternative path is to simulate the total length that the laser beams must travel to reach the ion source. Thus, these two lengths will have approximately the same size at the end of the path, i.e. in the ion source for one and in the laser room for the other (checking in display screen or CCD camera).

In the laser room, the screen is used as a visual reference point to visualize the laser beam and to optimize the spatial overlap of each laser position. The diffraction grating is used to divide the different wavelength components (i.e. divide each laser beam). Each of these components is then recorded by a CCD camera that makes it possible to control and optimize the size of each laser beam.

In addition, a telescope is included (opposite the first prism of the periscope for the GANIL system) to look into the ion source and to focus the IR laser light. A CCD camera interfaces between a computer and the telescope to record the data.



The combination of these three systems (visual reference point, CCD cameras and telescope) ensures an optimal control of the laser beams in the ion source. It should be noted that fine optimization of the relative positions and size of the laser beam can be performed by analyzing the signal enhancement of the ion beam.

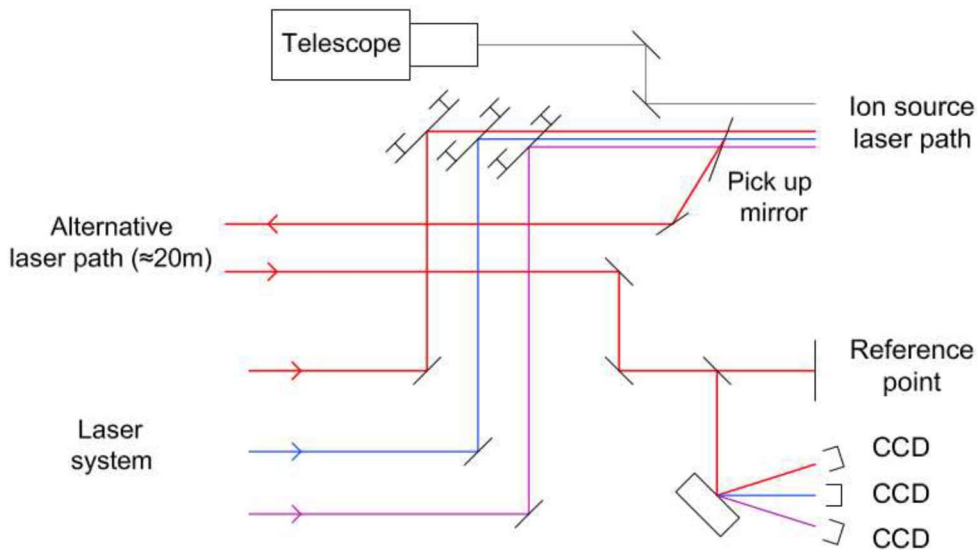

**Figure 9.** Control and optimization of spatial overlap and laser spot size [1].

## 5.2 Temporal Overlap.

As a reminder, for resonant excitation and efficient ionization, the laser pulses must, in addition to an optimal spatial overlap, arrive synchronized to the ion source. However, the laser cavities fire at different times that produces laser desynchronization. The four ways to optimize this temporal overlap (i.e. = synchronization of the Ti:Sa cavities) are presented below:

There are several methods for this such as the use of the position of the focusing lens of the pump laser, the location of the Ti:Sa crystal with respect to the curved mirrors (SWP), the use of a delay generator or a Pockels cell, changing the laser input power in the Ti:Sa cavity.

To begin with, we start with the modification of the laser input power in the Ti:Sa cavity by the use of half-wave plates (cf. Figure 11). Indeed, the pump power has a direct influence on the accumulation time of the gain inside the Ti:Sa crystal and thus on the threshold for the population inversion. Thus, by modifying this power, we can play on the more or less delayed appearance of the laser effect and the "location" of the temporal pulse can be adjusted in relation to those of other lasers.

## 5.3 Control, synchronization and data acquisition.

In the room dedicated to the lasers, a control system will be integrated, under LabVIEW, of the whole device to control the parameters of the laser system but also to control and synchronize the elements requiring it:

- Measurement and recording of the wavelengths of the laser cavities by means of a lambdameter,
- Measurement and recording of the output power of the Ti:Sa cavities by powermeters,
- Synchronization of the laser beams produced in the Ti:Sa cavities.
- Motorization of some optics: BBO, BRF, etalon, grating, mirrors.
- Access of visualization of the beams on screen for control and optimization of spatial overlap and laser spot size.

Note: as already mentioned above, the acquisition of the different data will be controlled via a LabVIEW program. Different parameters of the ion source will also be displayed on the front panel of the LabVIEW program. So, even if they cannot be modified (an independent LabVIEW program will be created in parallel for the control of the ion source and mass separation commands), it is important to have these values in the laser room. Indeed, it is possible to optimize the parameters of the laser beam (wavelength, synchronization and overlap of the laser spot) by visualizing "live" the variations of the ion signal intensity.

#### 5.4 Cooling of the Ti:Sa crystal.

It will be done with a cooler and a home-made assembly [4].

## 6 Optical paths.

As a reminder, the cavities described above allow the selection of the appropriate wavelengths for the resonant photoexcitation of an element of interest. In the rest of this paragraph, we will now discuss the optical paths between the different elements mentioned above and present on the optical table (cf. Figure 10).

Two first categories can be defined:

- Before the Ti:Sa cavities : *i.e.* The path between the pump laser and the Ti:Sa cavities,
- After the Ti:Sa cavities: this includes, in a first step, the paths for the selection of the wavelengths with the different necessary frequency conversion modules and, in a second step, the paths of the selected laser beams for shaping and transporting to the ion source.

Moreover, in parallel to the two categories mentioned above, another type of optical path is necessary. It is the one for the diagnosis of laser beams: control of the energy of each beam, of the selected wavelength,...

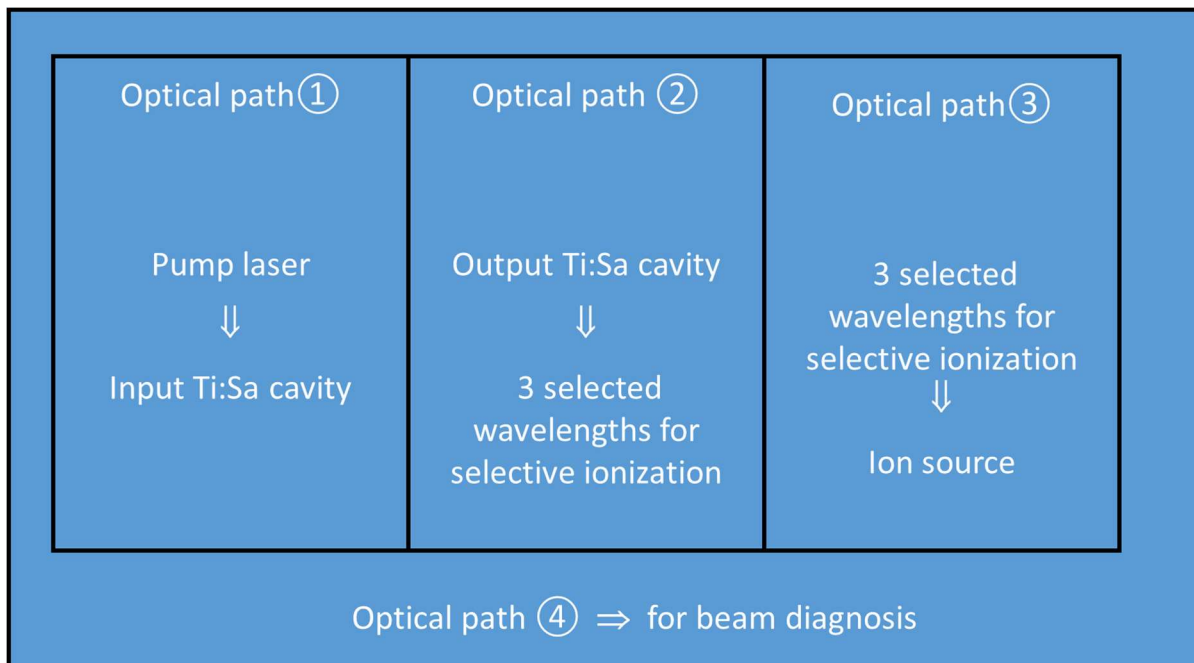
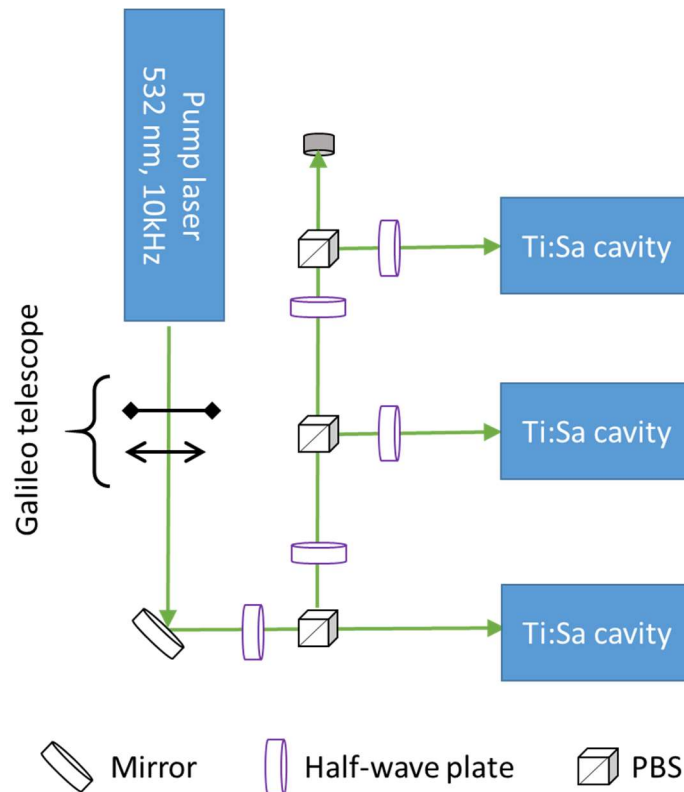

**Figure 10.** Categories of the different optical paths for a 3-cavity system Ti:Sa.

## 6.1 Optical path ①: before the Ti:Sa cavities.

The scheme for the SMILES device is visible on Figure 11, it is currently planned for 3 Ti:Sa cavities.

It is directly inspired by the assembly realized at GANIL [1].



**Figure 11.** Transport of the pump laser beam to the Ti:Sa laser cavities.

The beam emerging from the pump laser is therefore first enlarged by a Galileo telescope composed with a combination of concave and convex plane lenses. This allows controlling size beam. Then, the goal is to split this initial beam into several secondary laser beams in order to control independently the power going into each Ti:Sa cavity without modifying the initial pump power. To do this, the pump laser beam is reflected through a 45° mirror onto a system of half-wave plates in combination with polarized beam splitter cubes (PBS). This system works as follows: by its nature, the first half-wave plate will change the polarization of the incident beam by orienting it differently. When this "newly" polarized beam arrives on the splitter cube, the "p" polarized part will be transmitted while the "s" polarized part will be reflected at 45°. Thus, if the incident polarization is in an intermediate position between the "p" and "s" polarizations, the laser beams are splitted into two beams in a certain energy ratio that depends on the angle of the half-wave plate. In this way, it is possible from a single pump laser to control the amount of power delivered to each Ti:Sa cavity.



This diagram must be repeated as many times as there are Ti:Sa cavities.

## 6.2 Optical path ②: from the output of the Ti:Sa cavity to the selected wavelength for selective ionization.

As seen previously, there are several cases that allow the generation of the different harmonics (see Tableau 1) but different operations must be carried out in order to recover only those really necessary for each experiment. In order to achieve this goal, there are therefore, in a general way, five main actions that can be implemented:

- Beam splitting,
- "Re-direction" of beams,
- Polarization modulation,
- Optical aberration correction,
- Beam stopping.

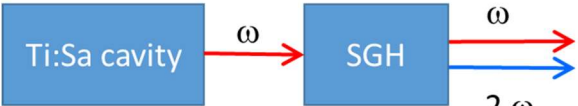
**Tableau 1.** *Different configurations and possible resulting actions.*

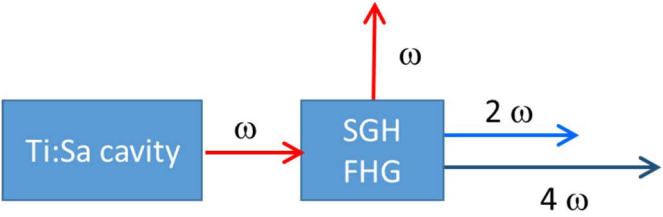
Different configurations for harmonic generation	Figures corresponding to the presented frequency generation module	Possible actions to be taken at the output of the « frequency
	Figure 6	Beam splitting
	Figure 7	"Re-direction" of beams Polarization modulation
	Figure 8	Optical aberration correction Beam stop

The separation of beams can be done using dichroic mirrors or splitter cube adapted to the needs of the experiment.

The "re-direction" of beams will be possible using HR mirrors adapted to the selected wavelengths: to avoid their multiplication on the optical table, it will be interesting to choose wide-band mirrors that can be used for different wavelengths.

The modulation of the polarization will be done by means of half-wave plates for the passage of the polarization "s" to "p".

Moreover, it will probably be necessary to "work" on the shaping of the beams. Indeed, for example, the beams coming out of nonlinear crystals often have an elliptical shape because of the birefringence and the different distances covered by the ordinary and extraordinary beams. However, this can be corrected by the use of sets composed of two cylindrical lenses perpendicular to each other.

Finally, the use of "beam-stop" will allow the stopping of the beams.

### 6.3 Optical path ③: from the selected wavelength for selective ionization to the ion source.

Before transporting the beams to the ion source, they must overlap spatially: this is presented in the first paragraph. The second paragraph is more specifically dedicated to the transport of the laser beams to the ion source, once this spatial overlap is effective.

### 6.3.1 Spatial overlap.

In order to maximize the efficiency of the ionization process of the atoms of interest, the spatial and temporal overlap of the laser beams inside the ion source is of major importance. Indeed, the experiment is extremely sensitive to changes in these two types of overlap. A procedure for achieving the optimal spatial overlap of three laser beams is presented below. The treatment of the temporal overlap is discussed in the chapter “System control”. (cf. § 5.2).

The three beams arriving on three different axes, the spatial overlap can be done either with splitter cubes (when the wavelengths are close enough) or dichroic mirrors.

When using dichroic mirrors, a simple logic is followed to take into account the mirror specificity (cf. Figure 12), the longer wavelengths should always be transmitted through the mirrors reflecting the shorter wavelengths (cf. Figure 13). This allows limiting the losses.

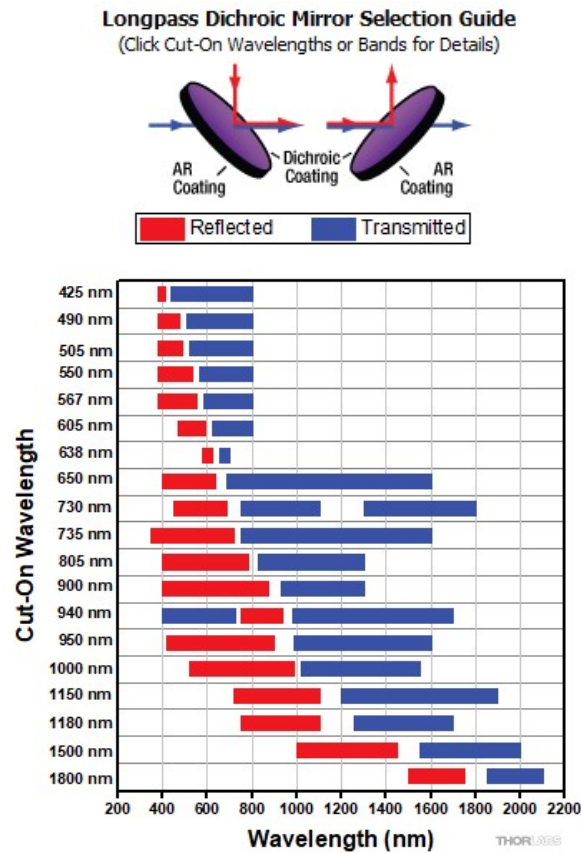

Figure 12. Typical reflectivity curves and representation of mirror alignment [4] [7].

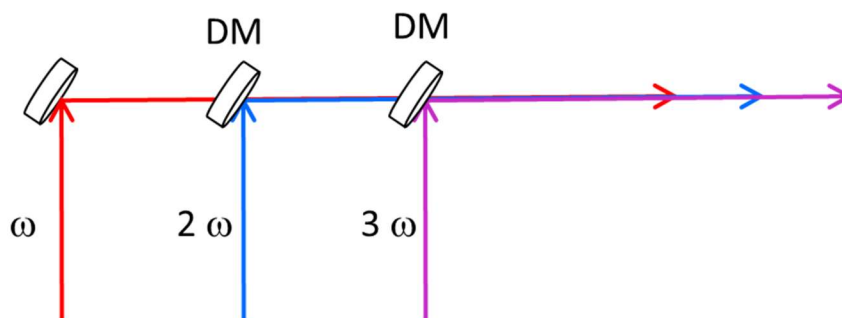

Figure 13. Dichroic mirror configuration for spatial overlap with minimal losses.

It should be noted that while, prior to the completion of the spatial overlap, each wavelength range (i.e. fundamental, second harmonic, third harmonic and fourth harmonic) has an independent optical path, with narrowband optics matched to the required wavelength, once the overlap is completed, all optics used thereafter must be able to support multiple wavelengths.

### 6.3.2 Transport to the ion source.

As the final configuration of the experimental rooms for the SMILES project is not finalized, the transport to the ion source cannot yet be clearly defined. However, a necessary point for this transport is the installation of Galileo telescopes on each beamline in order to control the focusing of the laser beams at the point of interaction in the ion source.

The technical characteristics of the telescope presented below are those set up at GANIL [1]. The principle for SMILES will be the same but the focal lengths of the lenses and their spacing will be adapted according to the distance between the laser room and the ion source.

Thus, at GANIL, the laser beams are enlarged by a factor of four by a plano-concave lens (focal length -50 mm or -75 mm) and then, they are focused by a plano-convex lens (focal length 200 mm). The distance between the two lenses varies between 0.1 and 0.15 m. This system allows controlling the size of the laser spot in the ion source (by modifying the distance between the lenses) at a distance of about 20 m, the goal of all this being to obtain the maximum ion signal.

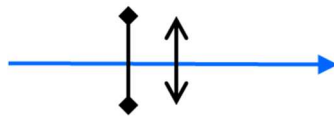

**Figure 14.** Galileo telescope for focus control in the ion source.

A possible configuration for future SMILES experimental rooms is shown Figure 15.

In this case, the output of the laser beam is sent “directly” to the ion source.

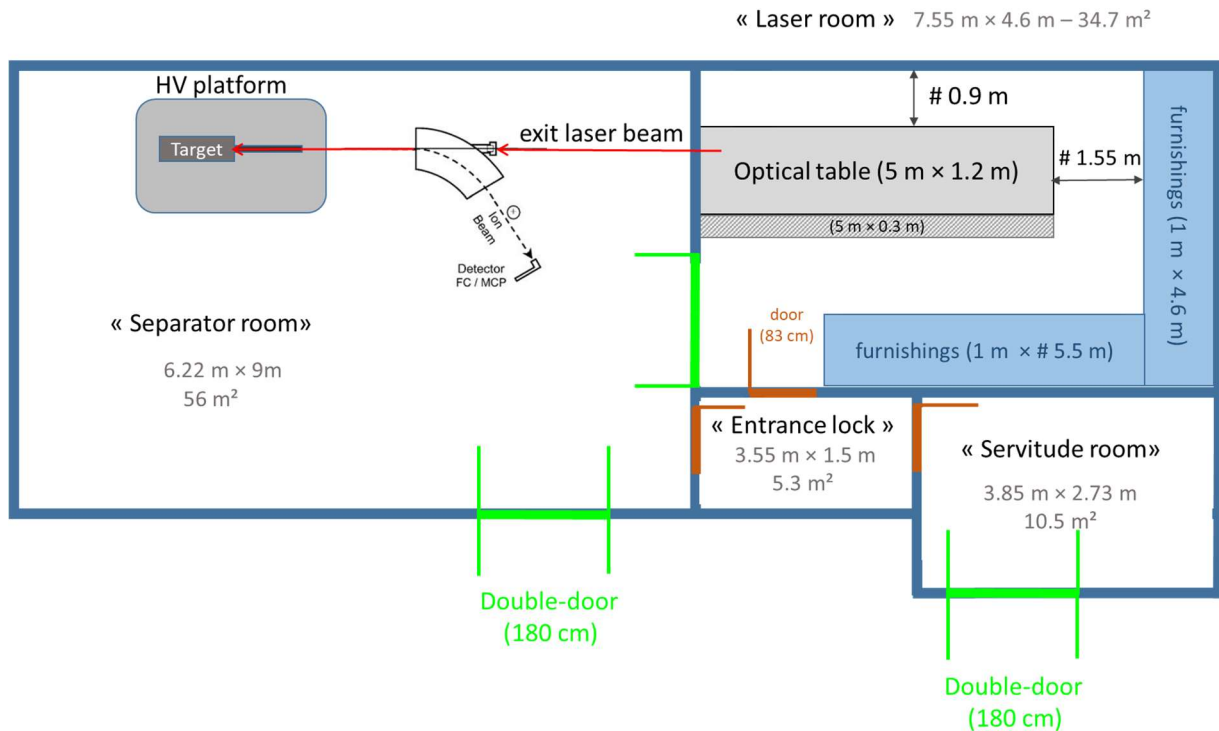

**Figure 15.** Possible layout for SMILES installation.

Thus, as shown in Figure 16, each beam line ( $\omega$ ,  $2\omega$  and  $3\omega$  in this case) passes through a Galilean telescope whose characteristics will be determined later according to the configuration of the experimental rooms (i.e. choice of the focal lengths of the lenses). Then, the spatial overlap of the three beams is achieved using dichroic mirrors. The resulting laser beam can then be directed out of the "Laser room" to the ion source.

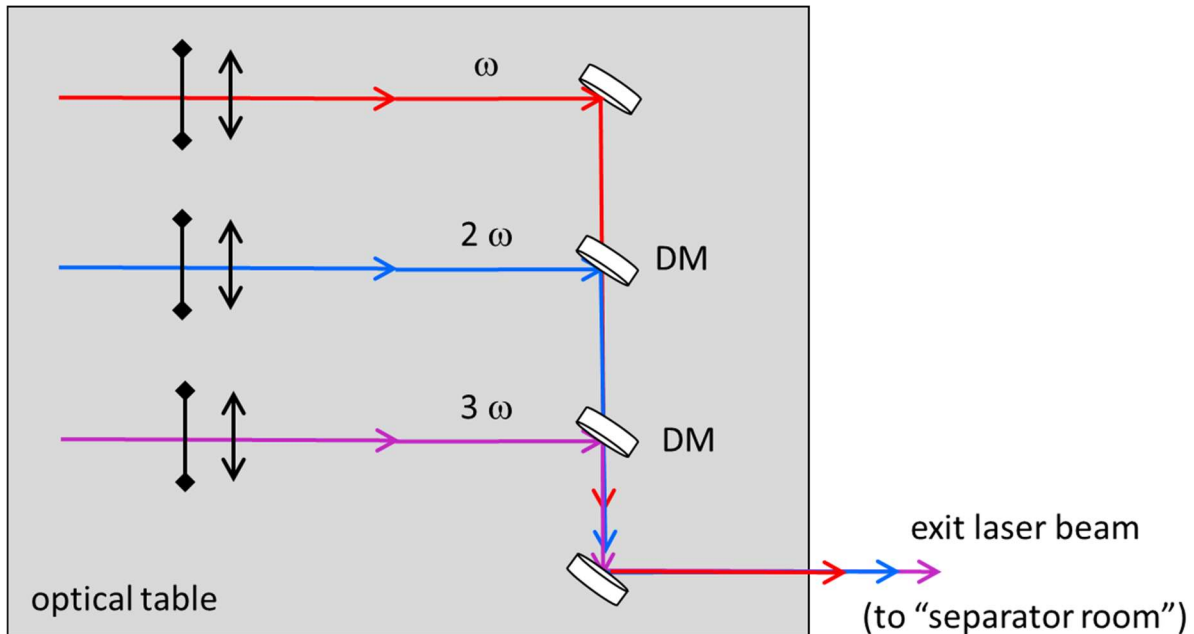

**Figure 16.** Possible configuration of the laser paths to the ion source.

#### 6.4 Optical path ④: for beam diagnosis.

Regarding the power measurements, they can be done by directly positioning the power measurement probes in front of the beam, if the range of the probe allows it.

For this direct measurement, a plano-concave lens can also be used to enlarge the laser beam and thus reduce the power per unit area at the entrance surface of the probe. Another way is to place a beam splitter in the path of the laser beam. It will reflect a known percentage of the incident beam at  $45^\circ$  towards the measurement probe. The beam splitter must be adapted to the wavelength of the incident laser beam and must have a damage threshold able to withstand the beam flow.

The measurement of wavelengths is done before the doubling, tripling or quadrupling of the frequency, that is to say at the level of the cavity Ti:Sa. The values of the wavelengths obtained then during the generation of the various harmonics are simply calculated by dividing by 2, 3 or 4 (respectively for the doubling, the tripling or the quadrupling) the wavelength of the fundamental which is measured experimentally.

For this, in order not to lose power, it is preferable to use the reflected light of certain optics rather than the output laser beam. As shown in Figure 17, this can be done using the reflection of the beam at the back plate of the birefringent filter (BRF). This beam is then reflected by a metal mirror (Al) to an output of the cavity that is fibered to a lambda-meter via a fiber collimator (lens). Another solution may be to position a splitter blade adapted to the cavity outlet Ti:Sa in order to return part of the beam to the lambda-meter, but this reduces the power of the outgoing beam.

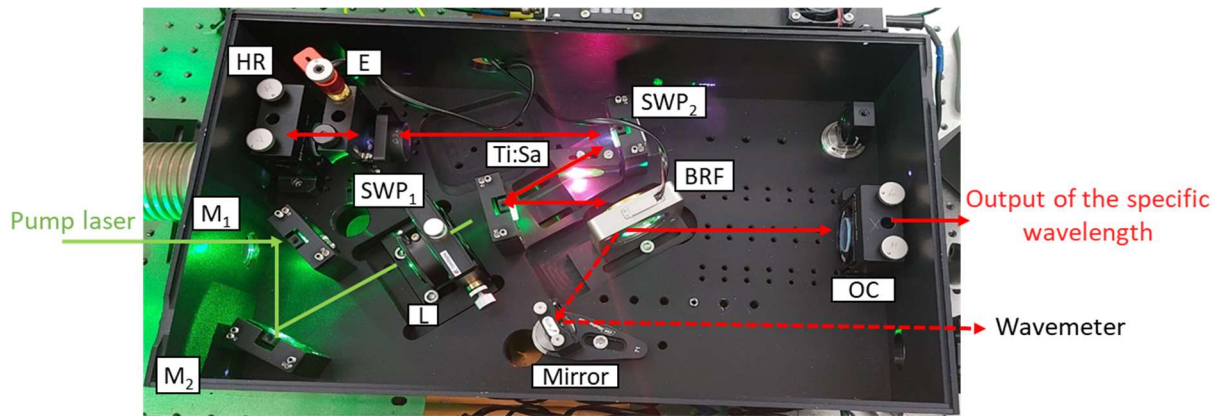

**Figure 17.** Example of a “BRF” cavity with an additional output to a lambdameter for wavelength control [1].

## 7 Main technical characteristics of the "Laser room".

A new building dedicated to the SMILES project will be built on the Subatech site. In this building, the "Laser room" will be specifically dedicated to the selective laser ionization device and to the electrostatic time-of-flight (TOF) separator (cf. Figure 15).

Due to its function, this room must therefore take into account some technical characteristics necessary to the proper functioning of the scientific instrumentation inside.

A first set of specifications for this room, defined after discussions with various interlocutors, is given below:

Surface: 30 m<sup>2</sup> (minimum surface) to 40 m<sup>2</sup>, ideally rectangular. Indeed, the optical table is about 1.2 m × 5 m (max = 1.5 m × 5 m): this small width must allow to easily reach the center with the arm.

Access: a double door (1.8 m wide, 2.5m high) allowing the entry/exit of lockable equipment (leading into the "Magnetic Mass Separator room", i.e. "Separator room") and a single door (0.83 m wide) leading into the entrance lock. The entrance lock is slightly depressured compared to the interior of the "Laser room", and slightly overpressured compared to "Separator room".

Temperature: regulated at 20°C, adjustable within a range of 18°C - 25°C at (+/- 0.5°C) or (+/- 1°C) if the constraint at (+/- 0.5°C) is too expensive and difficult to achieve

Humidity: regulated at 50%.

Floor: resin mortar.

Floor load: 350-500kg/m<sup>2</sup>.

Wall: matte surface, washable, without joints

Ceiling: matt color

Ceiling height: 2.7 m

Cooling service (cold water system): 10 kW cooling capacity outside the laser room (i.e. in the "Servitude room")

Power supply: 10 kVA normal + corrugated / Independent laser power supply - laser power supply bay in independent room (i.e. in the "Servitude room")



Primary pump: outside the room (i.e. in the "Servitude room")

Fire detection: yes

Anoxia detection: yes (gas and/or liquid nitrogen use)

Access control: yes (unless integrated into the "Separator room"); Presence of a laser safety interlock device on the accesses with interior / exterior signage

Other particularity:

The room must be blind. It must be accessible at ground level.

There must be a copper ground plane under the optical table, with at least 4 points connected to earth.

This room must be exposed to the lowest possible level of radiological background noise.

It must be adjacent to the "Separator room".

Cold water loop supply

Compressed air network supply

## 8 Conclusions and questions to the expert's committee.

After this presentation of the technical solutions envisaged for the selective laser ionization system of the SMILES project, we already have an idea of the configuration of the system and its environment but some questions and points to consider can be addressed:

Which system configuration should we start with?

- 3 "BRF" cavities (cf. Figure 1) or 2 "BRF" cavities and 1 "Grating" cavity (cf. Figure 2)? What about the availability of cavities?
- Frequency conversion unit: what choice ( $\omega$  and/or  $2\omega$  and/or  $3\omega$  and/or  $4\omega$ )? What about the availability of cavities? Validity of the choice of frequency conversion outside the Ti:Sa cavity?
- Validation for the choice of temporal overlap: in this report, the choice was made on one procedure but there are several others: advantages and disadvantages of each? Should Pockels cells be added to the Ti:Sa cavities for near wavelength discrimination, or would it be better to work on the position of the focusing lens on the Ti:Sa rod,...
- Validation of the choice of optical paths (excluding cavities), and actions to be implemented on the beams?
- Exit laser beam: a first possibility, with the use of 4 dichroic mirrors, was presented in the report (cf. Figure 16) a second one, only with 3 dichroic mirrors is shown on Figure 18: is there an advantage to do more one than the other?

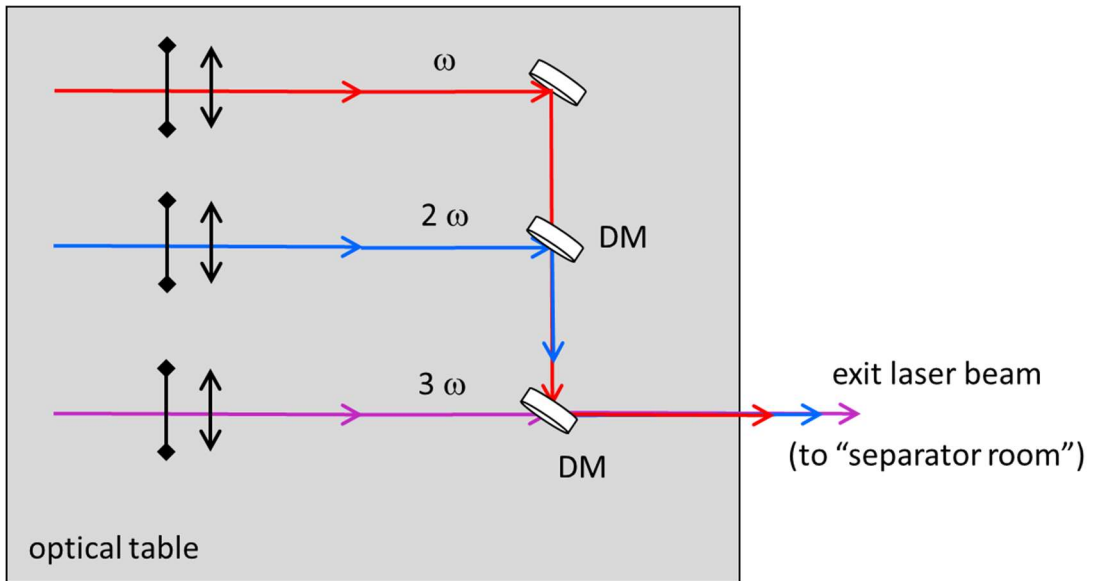

**Figure 18.** System implemented in Saariselka, Finland (K. Wendt - EURONS LASER & Trapspec 2007).

- Beam visualization: to be implemented in the future? In this way? (IR light?)
- Mirrors after Ti:Sa cavities: suitable for several wavelengths?

From a more technical point of view:

- Validation of the pump laser characteristics?
- Validation of the mirror sets for the Ti:Sa cavity?
- Questions to complete technical informations on some optical components (grating, beam expander, BRF, BBO, SWP,...)?
- Regarding Ti:Sa and frequency conversion cavities, do we need to buy specific mounts for the optics? (as, in the cavities (cf. Figure 19, Ti:Sa cavity example), there are predefined locations for optical components).

a)

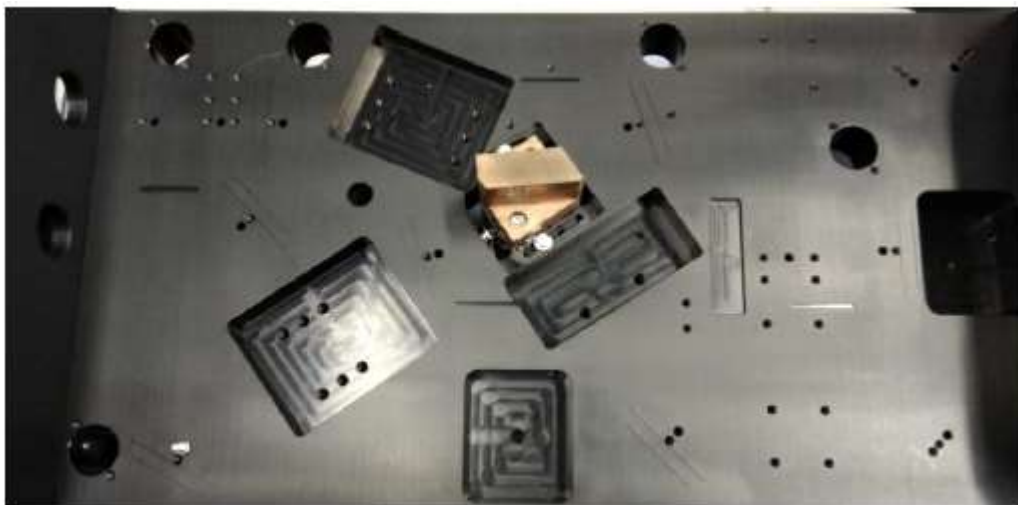

b)

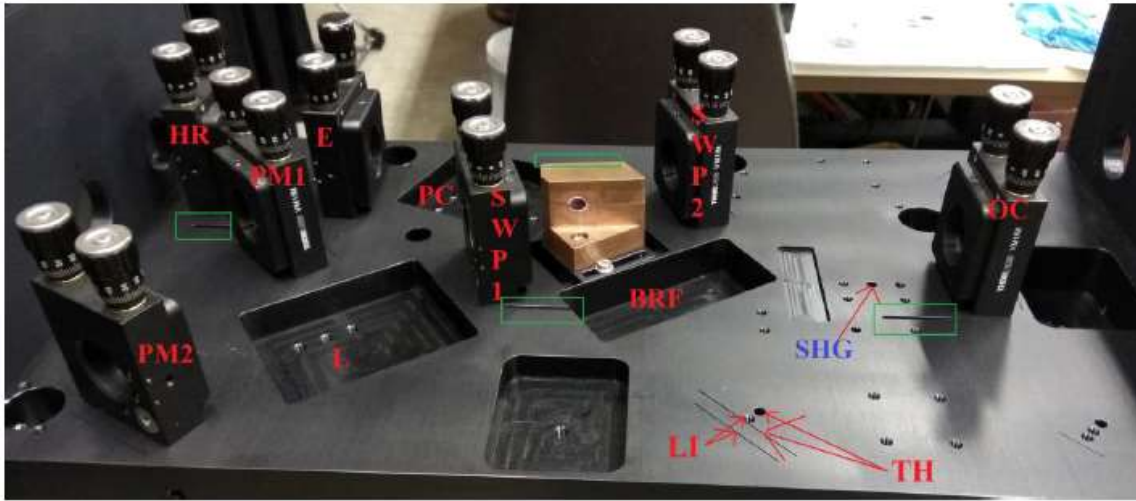

**Figure 19.** *Cavity Ti:Sa: base plate layout design a) top view; b) side view, with some optomechanics in place [4].*

- Lambdameter, powermeter (and probe): what precision needed for our objectives?
- Cooling system and Ti:Sa mount?
- Is the size of the optical table reasonable (cf. Figure 15)?
- Need for a metallic ground plane under the optical table?

For control, synchronization and data acquisition:

- Use of LabVIEW or other more suitable development software?
- Plan the motorization of the optics from the beginning?

Miscellaneous:

- Thicknesses of the etalon?
- Choice of focal lengths for the lenses?
- Use of Pellin Broca prisms?
- Laser safety: what to watch out for?

## 9 Bibliography.

- [1] J.L. Henares Gonzales, thesis, "Study of Condensable Ion Production by Resonant Laser Ionization" (2016)
- [2] Rapport Keertahana Kamalakannan: "Facilities at JG University" (2022)
- [3] Tobias Kron; Dissertation on Ionization Efficiency in Palladium and Spectral Resolution in Technetium; Johannes Gutenberg-Universität in Mainz, Germany (2016)
- [4] Jekabs Romans, « TiSa laser operation manual for setup, maintenance and service personnel » and "TiSa laser operation manual for users" (2019)
- [5] Nathalie Lescene "CAHIER DES CHARGES DU LASER DE POMPE POUR LE POMPAGE DE CAVITÉS TISA" GANIL (2020)
- [6] C. Mattolat, S. Rothe, F. Schwellnus, T. Gottwald, S. Raeder et al., "An All Solid State High Repetition Rate Titanium:Sapphire Laser System For Resonance Ionization Laser Ion Sources", AIP Conf. Proc. 1104, 114 (2009); doi: 10.1063/1.3115586
- [7] Thorlabs, Inc. "*Longpass Dichroic Mirrors/Beamsplitters*". Retrieved from: [https://www.thorlabs.com/newgrouppage9.cfm?objectgroup\\_id=3313#3630](https://www.thorlabs.com/newgrouppage9.cfm?objectgroup_id=3313#3630)

## 10 Listing of figures

<b>Figure 1.</b>	Schematic diagram with three “BRF” cavities. ....	5
<b>Figure 2.</b>	Schematic diagram with two “BRF” cavities and a “Grating” one.....	6
<b>Figure 3.</b>	Schematic diagram of the cavity without wavelength selection systems.....	8
<b>Figure 4.</b>	Schematic diagram of the “BRF” cavity.....	9
<b>Figure 5.</b>	Schematic diagram of the “Grating” cavity.....	9
<b>Figure 6.</b>	Second harmonic generation in extra-cavity Ti:Sa.....	13
<b>Figure 7.</b>	Frequency conversion unit for third harmonic generation [1].....	13
<b>Figure 8.</b>	A two steps fourth harmonic's generation.....	14
<b>Figure 9.</b>	Control and optimization of spatial overlap and laser spot size [1].....	16
<b>Figure 10.</b>	Categories of the different optical paths for a 3-cavity system Ti:Sa.....	17
<b>Figure 11.</b>	Transport of the pump laser beam to the Ti:Sa laser cavities. ....	18
<b>Figure 12.</b>	Typical reflectivity curves and representation of mirror alignment [4] [7].....	20
<b>Figure 13.</b>	Dichroic mirror configuration for spatial overlap with minimal losses. ....	20
<b>Figure 14.</b>	Galileo telescope for focus control in the ion source.....	21
<b>Figure 15.</b>	Possible layout for SMILES installation.....	21
<b>Figure 16.</b>	Possible configuration of the laser paths to the ion source.....	22
<b>Figure 17.</b>	Example of a “BRF” cavity with an additional output to a lambdameter for wavelength control [1].....	23
<b>Figure 18.</b>	System implemented in Saariselka, Finland (K. Wendt - EURONS LASER & Trapspec 2007).....	25
<b>Figure 19.</b>	Cavity Ti:Sa: base plate layout design a) top view; b) side view, with some optomechanics in place [4].....	26

11 Listing of tables.

**Tableau 1.** *Different configurations and possible resulting actions..... 19*