



HAL
open science

Impact of Hydrogen fuel on overall design of transport aircraft

Eric Nguyen Van, Julie Gauvrit-Ledogar, Cédric Julien, Bernard Paluch,
Jiangheng L Ruan, Frédéric Moens

► **To cite this version:**

Eric Nguyen Van, Julie Gauvrit-Ledogar, Cédric Julien, Bernard Paluch, Jiangheng L Ruan, et al..
Impact of Hydrogen fuel on overall design of transport aircraft. ICAS 2024, Sep 2024, Florence, Italy.
hal-04778307

HAL Id: hal-04778307

<https://hal.science/hal-04778307v1>

Submitted on 12 Nov 2024

HAL is a multi-disciplinary open access archive for the deposit and dissemination of scientific research documents, whether they are published or not. The documents may come from teaching and research institutions in France or abroad, or from public or private research centers.

L'archive ouverte pluridisciplinaire **HAL**, est destinée au dépôt et à la diffusion de documents scientifiques de niveau recherche, publiés ou non, émanant des établissements d'enseignement et de recherche français ou étrangers, des laboratoires publics ou privés.



IMPACT OF HYDROGEN FUEL ON OVERALL DESIGN OF TRANSPORT AIRCRAFT

Eric Nguyen Van¹, Julie Gauvrit-Ledogar², Cédric Julien³, Bernard Paluch⁴, Jiangheng L. Ruan⁵ & Frédéric Moens⁶

¹ONERA, DTIS, Université de Toulouse, 31000, Toulouse, France

²ONERA, DTIS, Université de Paris Saclay, 91120 Palaiseau, France

³ONERA, DMAS, Institut Polytechnique de Paris, 92190 Chatillon, France

⁴ONERA, DMAS, 59000 Lille, France

⁵ONERA, DMPE, Université de Paris Saclay, 91120 Palaiseau, France

⁶ONERA, DAAA, Institut Polytechnique de Paris, 92190, Meudon, France

Abstract

This paper outlines the research activities conducted by ONERA, focusing on the impact of hydrogen use on the design of transport aircraft. Specifically, the paper presents the research efforts made to enable the study of hydrogen aircraft, understand the impact of hydrogen on the overall design of the aircraft and characterise the performance of a hydrogen fuelled transport aircraft. The study presented in this paper focuses on Small to Medium Range aircraft (SMR) and on two aircraft configurations: a traditional Tube and Wing (T&W) aircraft and a more advanced Blended Wing Body (BWB). The intermediate results suggest that hydrogen has a major impact on the masses and energy efficiency of the aircraft. These impacts depend on the gravimetric index of the hydrogen tank at the first order. Furthermore, the impacts are especially high for T&W aircraft, while the BWB concept seems to be less sensitive to the change of fuel and a better candidate for the use of hydrogen fuel.

Keywords: Hydrogen Fuel, Overall Aircraft Design, Blended Wing Body, Tube And Wing aircraft, Small and Medium Range Aircraft

1. Introduction

Reducing the environmental impact of commercial aviation has gradually become a major objective guiding the development of aircraft. The ACARE, in Europe has set precise goals in terms of CO₂, NO_x and noise reductions [1], while the ICAO, in its agreement of 2023 on 'Net zero CO₂ goals' pushes in favour of direct actions to limit CO₂ emissions from planes and fuels [2]. Ultimately, the decarbonised scenarios presented by the ICAO rely on solutions that remain mostly based on carbon emitting fuels, either fossil fuel or SAF. Hence, no scenario allows complying with the objective of the Paris agreement to maintain the temperature increase to 1.5°C with respect to the pre-industrial era. To further reduce the emissions of air transportation, and render its impact compatible with the growth of the sector, a carbon-free energy is essential, and the use of hydrogen appears today as a promising solution to explore. In fact, the ICAO in [3] identifies hydrogen aircraft as an enabler of a zero emission aircraft that could significantly contribute to a clean aviation after 2050.

Hydrogen appears to be an effective solution for carbon-free commercial aviation, firstly because of the possibility of pooling large-scale production resources with other industries (automotive, steelworks, chemicals), and secondly because of its good production efficiency compared with other synthetic liquid fuels [4], [5]. However, liquid hydrogen is not a 'drop-in' fuel. The change from kerosene to hydrogen has a major impact on aircraft design, and it is crucial to quantify the consequences in order to have a clear vision of what future commercial transport aircraft using hydrogen as a fuel could be. Having such a vision based on scientific studies would then be critical to evaluate their feasibility in view of recent and foreseeable technological advances in the years to come and to decide on their contribution to a decarbonized commercial air transportation.

ONERA has decided to develop such a vision based on its experiences in Overall Aircraft Design [6], [7], [8], and its expertise in disciplines essential to the evaluation of a hydrogen aircraft: aerodynamics, combustion, structural analysis and handling qualities. Several projects were launched at ONERA, among which the project GRAVITY (GRoupe AVIon de Transport HYdrogène) aims at, on the one hand, identify the solutions required to address the technical issues inherent in the use of hydrogen in the operational context of aeronautics, and, on the other, quantify their overall impact on the design of commercial transport aircraft. The goal of this paper is to present the intermediate results of the project GRAVITY.

2. Scope and Methodology of the research project GRAVITY

The GRAVITY project is dedicated to the study of vehicles, and therefore concentrates only the scientific disciplines that are intrinsically linked to their design and the assessment of their performance. Thus, the project aims to address issues relating to on-board hydrogen storage, fuel distribution and the associated fuel circuit, the combustion chamber, the performance of hydrogen-powered engines, the generation of hydrogen-related contrails, and the system integration and design of hydrogen-powered transport aircraft. Topics such as hydrogen production and supply, airport operations associated with the use of hydrogen, and hydrogen characterization are not covered.

The skills mobilized for this work come from the different scientific departments of ONERA, forming a multidisciplinary team of experts. Consequently, the scientific and technological fields covered relate firstly to the modelling and design of systems directly concerned by the physical phenomena relating to the introduction of hydrogen as an alternative fuel for aircraft engines, with an impact on the following disciplines: energy and propulsion, materials and structures.

Secondly, the scientific and technological fields covered include vehicle integration and design, as well as performance assessment of commercial transport aircraft: characterization of aerodynamic performance, multidisciplinary design and optimization, and assessment of noise and pollutant emissions.

The present paper focuses on commercial transport aircraft in the Short/Medium Range segment (A320 segment and its successors), with the typical Top Level Requirements (TLARs) presented in Table 1. Only conventional turbofan engines are considered for the propulsion system. Given the estimated timeframe for the entry into service of hydrogen-powered aircraft, around 2035, the developments envisaged for these engines towards Ultra High By-pass Ratios (UHBR) will be taken into account as much as possible.

Table 1: Typical SMR Top Level Aircraft Requirements considered in this study.

Number of passenger (PAX)	150
Design Payload (kg)	13 600
Max Payload (kg)	19 500
Cruise Mach number (-)	0.78
Range (NM) [km]	2750 [5100]

Given the experience of the team and the tools available for preliminary sizing, two aircraft configurations are studied throughout the project: a classical Tube & Wing configuration using FAST-OAD [9] and a more radical Blended Wing Body aircraft using a dedicated BWB MDAO process [8], [10].

3. Disciplinary research

This section presents the research activities carried out within the different disciplinary groups: hydrogen storage, the effects on engine thrust and fuel consumption. These preliminary researches are then used for overall aircraft design to estimate the performance of hydrogen fuelled aircraft and compare them to equivalent kerosene aircraft.

3.1 Hydrogen tank

The gravimetric index is the main performance metric for the hydrogen tank. In this study, the gravimetric index includes the weight of the distribution system as well. It is defined as:

$$\text{Gravimetric Index} = \frac{\text{Hydrogen mass}}{\text{Hydrogen mass} + \text{Empty Tank mass} + \text{Distribution system mass}}$$

Even though liquid storage requires cryogenic temperature between 20K and 30K in order to limit internal pressure between 1 bar to 10 bar, there are examples of liquid hydrogen tank reaching a gravimetric index up to 0.6 [11] or higher [12], compared to 0.05 to 0.06 for state of the art compressed storage [13].

To maintain the thermal insulation of the tank, two solutions are often proposed. The first is based on the use of foam with different level of porosity (open or closed). This solution often used for space launchers is cost effective and easy to put into production while its thermal effectiveness is sufficient to prevent venting of hydrogen for applications limited in time (typically for launchers, in the order of several minutes, compared to at least several hours for aircraft). The second solution is based on a DEWAR vessel composed of a double envelop separated by vacuum and a multilayer insulation (MLI). Although more difficult to manufacture due to the level of vacuum (of the order of 10^{-7} bar), this solution offers the best insulation and consequently is better suited for long lasting operations, typically long range mission or an overnight stay at a distant airport.

In GRAVITHY, the requirements for the hydrogen tank (see Table 2) were chosen to offer at least twelve hours of dormancy time (without need to vent gaseous hydrogen) after arrival at a gate. Based on the literature and previous studies, only the DEWAR vessel with MLI seems able to meet such a stringent dormancy requirement.

Two basic types of tank designs are often considered: integral, where the external envelop of the tank carries the fuselage structural loads; and non-integral, in which the tank and the fuselage are two separate structures. For the purpose of inspections, maintenance and repair, the non-integral tank design has been selected as the primary concept, although comparison with integral tanks is planned during the project.

Table 2: Liquid hydrogen tank design requirements.

	State of the art [11]	GRAVITHY requirements
Dormancy time	Typical turn-around time (<1h).	12h
Aircraft integration	Integral tanks	Non integral tanks
Operating pressure	1.2 – 1.5 bars	2 bars
Venting pressure	3-4 bars	4 bars
Insulation	Polyurethane Foam	MLI

The geometry of the tank is presented in Figure 1. The tank uses torispherical ends and a tapered side to maximize the use of the internal volume in the rear fuselage where the cross section reduces. The tank consists of two walls:

- The inner wall, containing the LH2. At present, due to the severity of the requirement on tightness for this vessel, it is uncertain if composite materials are an appropriate choice, since the thermal stresses induced by the cryogenic temperatures are sufficient to initiate matrix cracking, and thus potential H2 leakage. For the time being, it is preferable to use lightweight alloys such as aluminium 6061, which has excellent properties at cryogenic temperatures [12].
- The outer wall, surrounding the inner wall, provides mechanical strength and protection. A high level of vacuum is maintained in between these two walls, combined with a multi-layer insulation installed on the inner wall. As the outer wall temperature will be significantly higher than that of

Impact of hydrogen fuel on overall design of transport aircraft

the inner vessel, the choice of material for this structure is not as critical, and standard light alloys can be used, as well as composite materials for an even lighter structure.

In the case of integral tank, the outer wall can contribute to the structural strength of the fuselage.

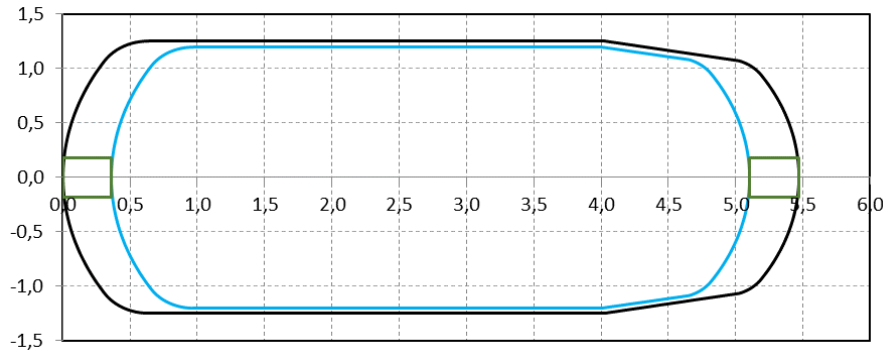

Figure 1: Selected concept (DEWAR vessel) for the liquid hydrogen tank.

Based on the literature [13], [14], [15], a thermal analysis and a pre-dimensioning method were built to estimate the total internal and external volume of the tank based on the required mass of hydrogen, the filling condition and the maximal admissible pressure (see Table 2).

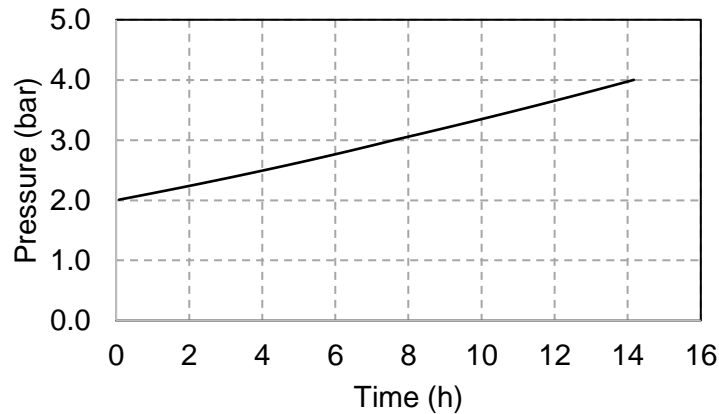

Figure 2: Evolution of pressure in the hydrogen tank, at ground level after fuelling for a reduced mission.

Considering a tank with high-performance insulation (vacuum + multi-layers), at ground level, after fuelling for a reduced mission (typically 800NM), the thermal analysis method estimates a dormancy time of 14h (see Figure 2). The thermal analysis estimates heat fluxes entering the tank considering natural convection with a constant 15°C maintained in the environment surrounding the tank, regardless of the operating conditions of the aircraft.

3.2 Engine

The main challenge for the use of hydrogen in a turbofan engine is the redesign of the combustion chamber. In adiabatic condition, the combustion of hydrogen produces a higher temperature than the kerosene (between 100K and 200K). The high temperatures being the source of NO_x formation, using the same conditions as with kerosene would result in higher NO_x production. Therefore, in the GRAVITY project the efforts are concentrated in designing a new combustion chamber based on Lean Premixed Combustion and enabling low NO_x production. These efforts are part of the solutions developed to enable the hydrogen aircraft. In parallel, further developments of an in-house code for preliminary sizing and performance evaluation of turbofan engine led to first performance estimations of a 2020 turbofan engine functioning with hydrogen.

Table 3: Comparison between a kerosene (jet A) and hydrogen version of the LEAP A1 turbofan engine reproduction.

Altitude (km)	Mach	T4 (K)	Thrust JetA (kN)	Thrust H2 (kN)	TSFC JetA (g/kN/s)	TSFC H2 (g/kN/s)	Ratio TSFC JetA/H2
0	0	1720	120.2	115.9	8.19	2.77	2.96
10	0.78	1720	31.5	29.9	16.27	5.59	2.91
12	0.78	1740	13.3	13.0	15.73	5.53	2.84

Initially, we observe in Table 3 that hydrogen-powered engines produce slightly less thrust than kerosene-powered engines: around 4% at take-off and 2% at cruise. Nonetheless, thrust values are broadly similar, so it seems possible to keep the same engine architecture while using hydrogen. The ratio of Thrust Specific Fuel Consumption (TSFC) between kerosene and hydrogen is shown in the last column of the table. This TSFC ratio is 5 to 10% higher than the PCI ratio between the two fuels (2.76). This difference is due in particular to the higher calorific capacity of the exhaust gases produced by hydrogen-air combustion, compared with kerosene. This result is consistent with the literature (see [16]).

4. Overall aircraft design exploration

In this section, the disciplinary investigations conducted in section 3 are integrated into the two OAD software for evaluation of small and medium range Tube and Wing (4.1) and Blended Wing Body (4.2) using hydrogen as fuel and according to the TLARs presented in Table 1. The conditions listed in Table 2 are assumed for the storage of liquid hydrogen and a DEWAR vessel with MLI thermal insulation, as presented in Figure 1, is considered for the design of the aircraft. As seen in 3.2, the switch to hydrogen fuel has a small impact on engine performance; consequently, it is assumed no impact on the engine thrust and efficiency. Only the fuel consumption is corrected by the ratio of lower heating value between hydrogen and kerosene. For both concept, the work starts by finding a suitable position for the hydrogen tanks. Then, the OAD software is modified in order to take into account the tank weight and centre of gravity and propagate the changes in terms of added weight and wet surface area. The fuel consumption is evaluated by time simulation of the design mission and the process is looped until MTOW converges.

4.1 Tube and Wing configuration

The initial work performed for the T&W configuration included a critical review of the different concepts found in the literature. A decision matrix with safety and operational consideration was used to perform a first down-selection. Then, because the volume of a liquid hydrogen tank will remain between four to six times larger than the volume occupied by kerosene for the same amount of energy, a simple integration test was realized to identify the configurations able to contain such a large volume. The test consisted in the integration of a 120m³ hydrogen tank. This volume corresponds to the required volume to embark the same amount of energy as the kerosene reference aircraft, including insulation and a volumetric efficiency of 0.85. After elimination of a configuration with tanks integrated in the wing root, only three configurations were judged worth to study in more details. Those are the podded tank, the top tank and the rear tank configurations (respectively a., c. and d. in Figure 3).

Out of these three configurations, the rear-tank is the simplest to study at OAD level. The tank being non-integral, the rear-tank configuration requires only a stretch of the fuselage and a redefinition of the cabin and of the interior of the fuselage. This can be reasonably studied at a preliminary stage with the disciplinary models included in FAST-OAD. It is also possible to consider a twin aisle cabin in an attempt to limit the fuselage length and a circular or a flattened cross section.

Among the modifications needed to model the rear tank configuration, the following have been implemented: the fuselage internal layout has been updated considering a minimum spacing of 0.5m between the rear cabin bulkhead and the tank. A double tank architecture has been selected to allow

Impact of hydrogen fuel on overall design of transport aircraft

for redundancy, with a spacing of 0.5m between each tank. These spaces are intended to be occupied by the fuel distribution system.

The tanks diameter is set equal to the cabin height and the necessary length is deduced from the fuel consumed during the mission. If possible, the rear tank is partly located inside the rear fuselage length. Since the fuel is now located inside the fuselage, the wing load calculation has been modified to neglect the bending moment relief of the fuel weight.

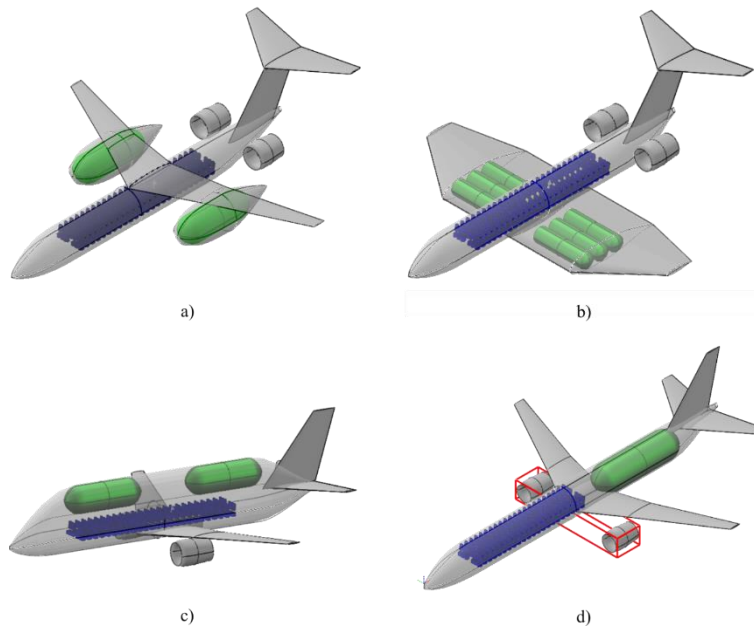

Figure 3: Integration test of a 120m³ hydrogen tank on a typical SMR aircraft geometry.

Additional assumptions for the design of the rear-tank configuration include a constant approach velocity of 136knots that is sizing the wing and a constant thrust to weight ratio of 0.34. The specific fuel consumption is adjusted to account for the change of fuel.

The overall aircraft performances of the single and twin-aisle hydrogen aircraft are compared to the reference kerosene aircraft in Table 4 for a gravimetric index of 0.35. The results show a larger weight increase mostly due to the large tank weight (~17T) and the snow ball effect (wing area increased by 60%) despite the lower fuel weight. The energy consumption is at least 45% higher with the hydrogen concept and the fuselage length is reaching 56m for the single aisle aircraft. The two twin-aisle concept are less efficient but allow a reduction of the maximum fuselage length, with the flattened concept being advantage against the cylindrical cross-section due to lower weight and wet surface area.

Table 4: Tube and wing reference kerosene and LH2 aircraft characteristics for a gravimetric index of 0.35.

Parameters	Ref Kerosene	LH2 single aisle	LH2 twin aisle flattened fuselage	LH2 twin aisle cylindrical fuselage
MTOW (t)	72.6	105.6	110.5	112.9
MLW (t)	65.9	103.9	108.4	110.4
MZFW (t)	62.2	103.0	107.5	109.4
OEW (t)	42.6	83.4	87.9	89.8
Mission Fuel (including reserve) (t)	16.8	8.8	9.3	9.8
Block fuel (t)	14.2	7.5	7.9	8.3
Block energy (GJ)	613	896	944	991
Wing area (m ²)	122.9	194.4	202.7	206.4
AR	9.5	9.5	9.5	9.5

Impact of hydrogen fuel on overall design of transport aircraft

Span (m)	34.1	42.9	43.8	44.2
Fuselage length (m)	37.5	56.0	49.2	46.8
Fuselage maximum height (m)	4.1	4.1	4.2	5.7
Fuselage maximum width (m)	3.9	3.9	5.5	5.5
L/D max	17.4	17.7	17.4	17.0
MTO thrust (kN)	117.9	176.1	184.8	193.8

The results presented in Table 4 are very sensitive to the gravimetric tank index and a quick look at the literature shows that uncertainty remains high on the prediction of tank gravimetric index. On one part, this is due to the absence, at the moment, of a sizing model for the fuel distribution system and on the other part, this comes from the fact that at the moment, examples of construction are rare and not adapted to the scale of the aircraft. To circumvent the uncertainty due to the gravimetric index, the performance of the aircraft at OAD level are presented as a function of this index in Figure 4. Additionally, results from the literature (see [17], [18], [19], [20], [21], [22]) have been added to the graphic for comparison.

Figure 4 shows the evolution of weights, fuselage length and energy efficiency for the single aisle and of the twin-aisle with flattened fuselage aircraft. All the performance metrics are scaled with respect to the reference kerosene aircraft. These graphs show the very strong dependence of aircraft performance on the gravimetric index. It is also shown that at the same level of technology (EIS 2014), the configurations studied here fail to match the reference aircraft in term of fuel efficiency. Only the MTOW may be matched for a gravimetric index close to 0.8. The twin-aisle configuration is efficient at limiting the fuselage length at the cost of an energy consumption between 5% to 10% higher and a weight increased contained below 5% increase.

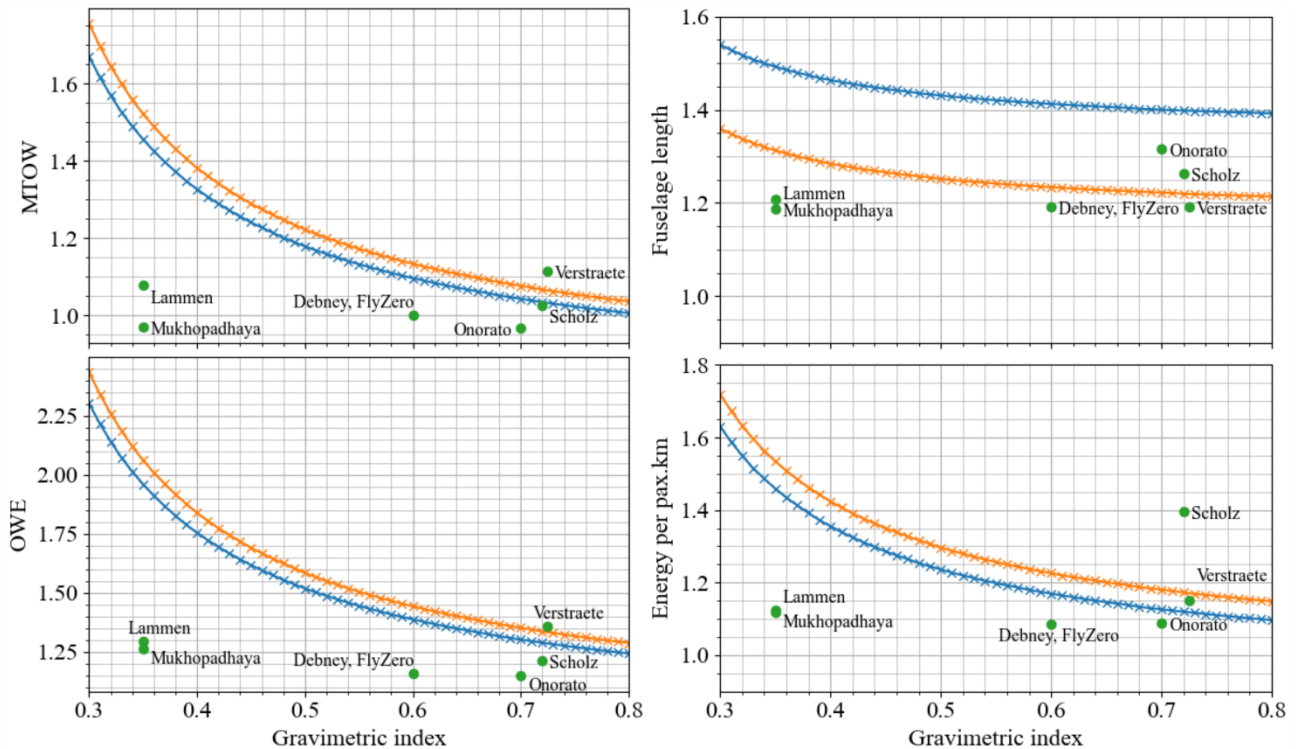

Figure 4: Performances of the SMR aircraft with respect to the reference kerosene aircraft. The blue line represents the single aisle cabin layout and the orange line represents the double aisle cabin layout with flattened fuselage.

To be able to compare with the literature, the results reported in Figure 4 are scaled with respect to the reference aircraft presented by each author. Each reference aircraft is of the same level of technology as the hydrogen variant. Comparison with the literature reveals a notable dependence on the technology level and the TLARs considered. Improvement in technology level refers essentially to incremental improvement of the engine, but may also include improvements in materials, structure and

aerodynamics.

Scholz and Verstraete both consider EIS1990 technology level. However, Scholz is penalized by non-optimized tank integration while Verstraete takes into account the better fuel efficiency of hydrogen burning turbomachine (as seen in section 3.2) and integral tanks which grants a better overall fuel efficiency with a higher range. Onorato and Debney consider similar range as Verstraete but EIS2014 and EIS2035 respectively, which seems to explain the better fuel efficiency of Debney despite lower gravimetric index.

Finally, Mukhopadaya and Lammen consider EIS2014 and EIS 2035 respectively but both show contained masses, and good energy efficiency despite the low gravimetric index. This is because these authors consider lower design range (respectively 1720NM and 2000NM) that requires only small tanks and limit the total weight increase.

The curves presented here can be expected to translate downwards with a higher level of technology, but exceeding the performance of a kerosene-powered aircraft with the same level of technology is proving difficult. Also, the sharp rise in energy consumption with lower gravimetric index may be partly offset by limiting the design range of the aircraft until better tank designs are made available.

A rendering of the aircraft calculated in Figure 4 with a gravimetric index of 0.35 is shown in Figure 5. The majority of the fuselage after the wing is occupied by the hydrogen tanks, which leads to a large CG travel range (up to 60% of the MAC) especially between ferry flights and maximum zero-fuel weight. This results in a large empennage surface area as it can be noted in Figure 5. One solution to this problem is to keep the ferry flights exceptional and impose the use of ballast to limit the maximal rear position of the CG.

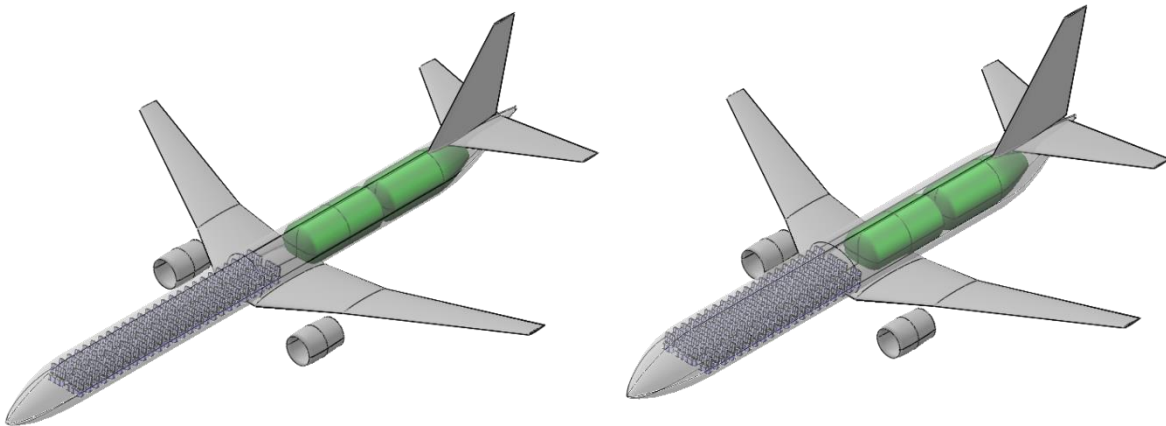

Figure 5: 3D rendering of the LH2 aircraft calculated with FAST-OAD. Left: single aisle cabin, right: twin-aisle cabin with flattened fuselage, gravimetric index = 0.35.

4.2 Blended Wing Body configuration

The Blended Wing Body (BWB) configuration is often mentioned as a good candidate for hydrogen, mainly due to the large internal volume of its central body. The geometry of the central body of BWB configurations offers a greater free volume than that of equivalent T&W configurations, making it easier to accommodate the voluminous hydrogen tanks.

As a result, it is often mentioned as a medium-term solution for hydrogen-powered transport aircraft, which could enter service after the conventional hydrogen Tube & Wing configurations [18]. This, combined with the BWB configuration's excellent performance proved in [10], has prompted further study of the integration of hydrogen as a new fuel in such a configuration.

The SMILE configuration [10] is used as the kerosene-fuelled reference aircraft. The same platform is used as baseline configuration for the study of hydrogen-powered short/medium-haul Blended Wing Body. The integration of the hydrogen tanks takes into account the internal layout and associated constraints. Consideration of the possible positioning of the hydrogen tanks revealed two areas to be avoided, in continuity with the cabin's two rear side doors, which must remain clear of all hazards to

Impact of hydrogen fuel on overall design of transport aircraft

enable passengers to evacuate onto the external wing in the event of an emergency, and in the event of obstruction of the front doors. Furthermore, the trailing edge of the central body cannot be used to house the tanks, as it is occupied by the control surfaces and has a very low thickness.

The solution consists in lengthening the rear of the central body to accommodate four cylindrical tanks behind the cabin. In addition, the two small volumes available in front of the two side bays are also used to accommodate two additional tanks. This solution, illustrated in Figure 6, keeps the cabin and the two side cargo holds unchanged, but modifies the external geometry of the initial configuration.

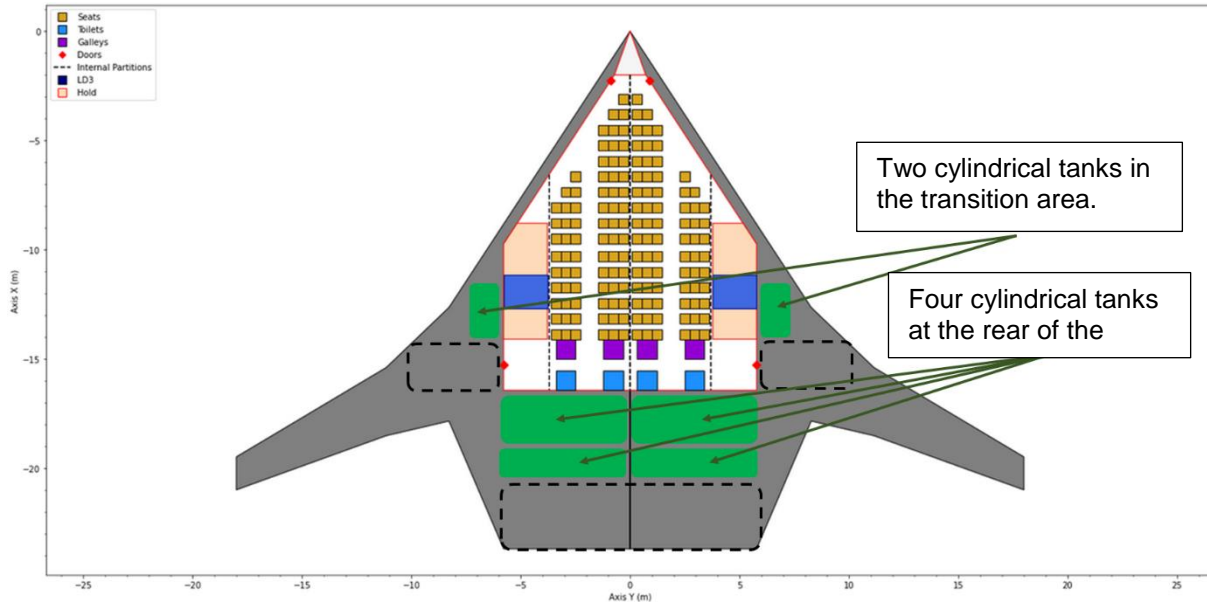

Figure 6: Top view of the integration solution selected for the BWB.

The iterative approach to estimate the performance of the hydrogen configuration described in Figure 6 leads to an estimated hydrogen volume of 71m^3 , i.e. a total tank volume of 83m^3 .

This means extending the central body by 5.1 m, including 3.8 m to accommodate the tanks and 1.3 m to increase the chord of the control surfaces located at the rear of the central body, so as to keep their relative chord at 15% of the total chord. The width of the central body was unmodified as well as the total wingspan.

Figure 7 shows the 3D geometry obtained, with the cabin and side bays in blue and the hydrogen tanks in green.

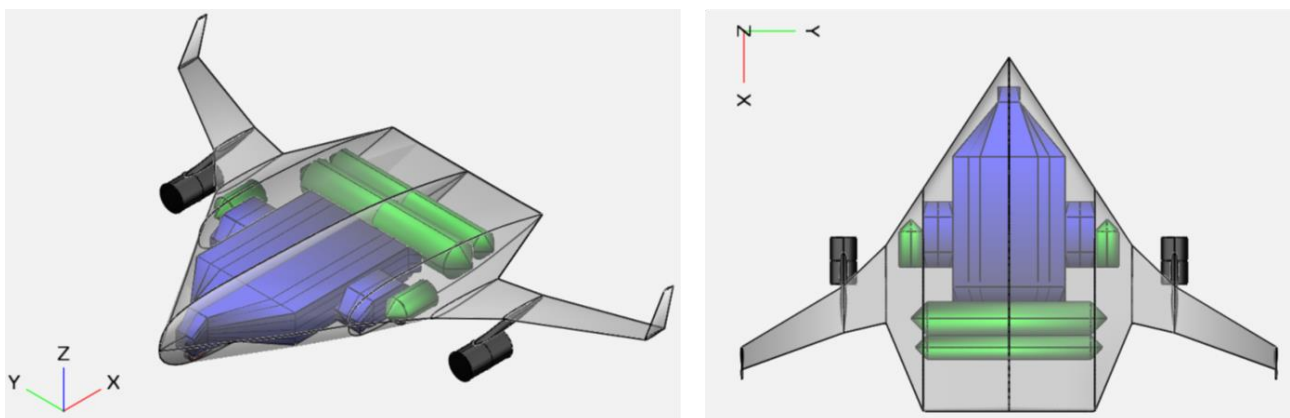

Figure 7 : 3D view of the tank integration in the BWB configuration.

Additional assumptions for the sizing of the hydrogen BWB configuration include technology level EIS2035 (same as SMILE), no impact of hydrogen on engine efficiency and a tank gravimetric index of 0.35.

Table 5 details the main characteristics of the hydrogen BWB configuration obtained and how it compares with the kerosene-fuelled SMILE reference configuration.

Table 5: Characteristics and performances of the BWB aircraft using a gravimetric index of 0.35.

	SMILE kerosene	SMILE H2	Difference
Number of passengers (pax)	150	150	0%
Range – Design mission (km)	5100	5100	0%
Range – Typical mission (km)	1500	1500	0%
Length (m)	18,7	23,8	27%
Wingspan (m)	36	36	0%
OEW (kg)	36556	48350	32%
PW (kg)	13500	13500	0%
MTOW (kg)	62462	66776	7%
FW – Design mission (kg)	12511	4964	-60%
FW – Typical mission (kg)	5513	2279	-59%
H2 volume (m ³)		71	-
H2 Tanks volume (m ³)		83	-
H2 Tanks mass (kg)		9136	-
MJ / pax / km – Design mission	0,71	0,78	10%
MJ / pax / km - Typical mission	1,06	1,21	15%
MJ / kg PW / km – Design mission	7,84E-03	8,65E-03	10%
MJ / kg PW / km - Typical mission	1,17E-02	1,35E-02	15%

These results show that while the hydrogen configuration fulfils the same mission in terms of passenger capacity and range, its operating empty weight (OEW) is increased by 32%, combining the 27% lengthening of the central body and the addition of around 9.1t of hydrogen tanks. As a result, although the mass of hydrogen fuel required is reduced by around 60% compared with kerosene, to carry out the same mission, the aircraft's maximum take-off weight (MTOW) is increased by 7%.

This increase in the aircraft's maximum take-off weight, deriving from its empty weight and therefore penalizing the aircraft throughout its mission, leads to an increase in its energy consumption (expressed in MJ/passenger/km flown or in MJ/kg payload/km flown) of 10% for the design mission and 15% for the typical mission.

In conclusion, despite a loss of energy efficiency in the hydrogen configuration with tanks located at the rear of the cabin compared with the kerosene-fuelled SMILE reference configuration, the integration of hydrogen seems feasible without reducing mission specifications (passenger capacity and range).

It should be noted, however, that the handling quality criteria considered in the design and optimization process dedicated to BWB configurations led us to move the engines, initially positioned aft of the central body on the SMILE configuration, under the outer wing, so as to resolve the balancing problems brought by the aft position of the hydrogen tanks. With this modification, it is estimated that all the flight handling quality criteria can be met by modifying the aircraft's overall centre of gravity by 40 cm towards the front. This order of magnitude can be achieved by adjusting the longitudinal position of the engines, or by modifying the positioning of the various internal components making up the cabin and side compartments.

4.3 Comparison between BWB and T&W aircraft

In this section, a comparison is proposed between the BWB and the T&W concepts. The same TLARs and technological assumptions are considered for the two aircraft allowing a fair comparison. The reference aircraft for the BWB is the SMILE study [10] and the reference T&W aircraft, a single aisle aircraft for EIS2035, uses the same engine performance as in SMILE .

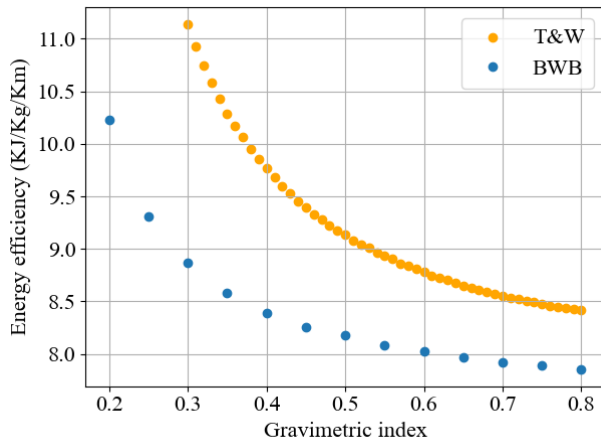

Figure 8 : Energetic efficiency of tube and wing and BWB hydrogen aircraft.

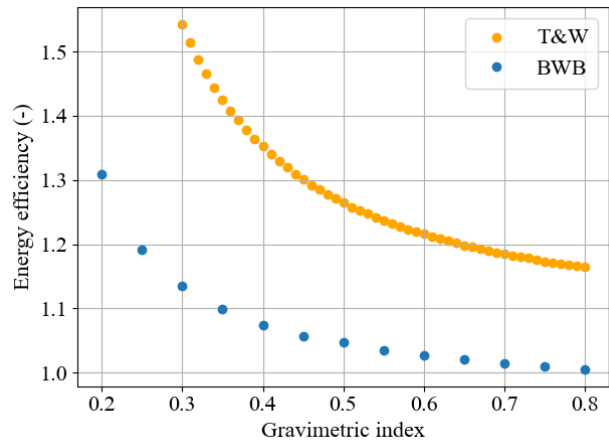

Figure 9 : Efficiency relative to the reference aircraft.

The figure 8 shows the energy efficiency of the two SMR concepts. The Figure 9 shows the relative energy efficiency with respect to their reference aircraft. The two figures show that the BWB concept has an advantage over the T&W concept. While the price to pay to carry hydrogen fuel remains high for the T&W aircraft, especially when compared to a reference aircraft, the BWB concept is limiting the impact of hydrogen integration within the airframe. This result seems to show that the BWB is a concept better suited for the integration of hydrogen fuel than the T&W aircraft.

5. Conclusion

While hydrogen fuel is seen as an enabler of a zero emission aircraft, the change from kerosene to liquid hydrogen fuel has a major impact on the design of the aircraft. At ONERA an initiative was launched to acquire a vision of what could be a hydrogen transport aircraft and how it compares to a kerosene aircraft. In this scope, the GRAVITHY project was initiated with the aim to assemble a team of multidisciplinary specialists to develop technological solutions enabling hydrogen aircraft and evaluate at the system level the expected performances of hydrogen aircraft. Building on the experiences gained with OAD tools, the project studies two aircraft concepts a typical Tube & Wing aircraft and a Blended Wing Body. Technological solutions are studied in the area of hydrogen storage and distribution, hydrogen combustion, structural design and contrails formation. All these solutions are then integrated at the system level and enable first characterization of hydrogen aircraft. It has been shown that globally the hydrogen aircraft are heavier and larger than the equivalent kerosene aircraft due to the large liquid hydrogen tanks. The energy consumption is highly dependent on the tank gravimetric index and remains higher than kerosene aircraft. Finally, it seems that the Blended Wing Body offers an advantage compared to the Tube & Wing aircraft in terms of performance when integrating liquid hydrogen fuel.

6. Copyright Statement

The authors confirm that they, and/or their company or organization, hold copyright on all of the original material included in this paper. The authors also confirm that they have obtained permission, from the copyright holder of any third party material included in this paper, to publish it as part of their paper. The authors confirm that they give permission, or have obtained permission from the copyright holder of this paper, for the publication and distribution of this paper as part of the ICAS proceedings or as individual off-prints from the proceedings.

References

- [1] European Commission. Directorate General for Research and Innovation. and European Commission. Directorate General for Mobility and Transport., *Flightpath 2050 :Europe's vision for aviation : maintaining global leadership and serving society's needs*. LU: Publications Office, 2011. Accessed: Mar. 24, 2022. [Online]. Available: <https://data.europa.eu/doi/10.2777/50266>
- [2] S. Mithal and D. Rutherford, 'ICAO's 2050 net-zero CO2 goal for international aviation', Jan. 2023.
- [3] B. Graver and J. Mukhopadhaya, 'VISION 2050: Aligning aviation with the Paris Agreement', *International Council on Clean Transportation*, Jun. 2022.
- [4] Fuel Cells and Hydrogen 2 Joint Undertaking., *Hydrogen-powered aviation: a fact based study of hydrogen technology, economics, and climate impact by 2050*. LU: Publications Office, 2020. Accessed: Feb. 09, 2022. [Online]. Available: <https://data.europa.eu/doi/10.2843/471510>
- [5] P. Su-ungkavatin, L. Barna, and L. Hamelin, 'Biofuels, Electrofuels, Electric or Carbon-free?: A review of current and emerging Sustainable Energy Sourcing for Aviation (SESA)', *engrXiv*, preprint, Jun. 2021. doi: 10.31224/osf.io/8sqpy.
- [6] S. Defoort *et al.*, 'Conceptual design of disruptive aircraft configurations based on High-Fidelity OAD process', in *2018 Aviation Technology, Integration, and Operations Conference*, in AIAA AVIATION Forum. , American Institute of Aeronautics and Astronautics, 2018. doi: 10.2514/6.2018-3663.
- [7] P. Schmollgruber *et al.*, 'Multidisciplinary Exploration of DRAGON: an ONERA Hybrid Electric Distributed Propulsion Concept', in *AIAA Scitech 2019 Forum*, San Diego, California: American Institute of Aeronautics and Astronautics, Jan. 2019. doi: 10.2514/6.2019-1585.
- [8] J. Gauvrit-Ledogar *et al.*, 'Multidisciplinary design and optimization process dedicated to blended wing body configurations', presented at the ICAS, Stockholm, Sweden, 2022. [Online]. Available: <https://hal.science/hal-03879906>
- [9] C. David, S. Delbecq, S. Defoort, P. Schmollgruber, E. Benard, and V. Pommier-Budinger, 'From FAST to FAST-OAD: An open source framework for rapid Overall Aircraft Design', *IOP Conf. Ser.: Mater. Sci. Eng.*, vol. 1024, p. 012062, Jan. 2021, doi: 10.1088/1757-899X/1024/1/012062.
- [10] J. Gauvrit-Ledogar, A. Tremolet, S. Defoort, F. Morel, R. Liaboeuf, and M. Méheut, 'Multidisciplinary Design and Optimization of the Blended Wing Body Configuration SMILE', presented at the 9th European Conference for Aeronautics and Space Science (EUCASS), Lille, France, 2022.
- [11] G. D. Brewer *et al.*, 'STUDY OF FUEL SYSTEMS FOR LH2-FUELED SUBSONIC TRANSPORT AIRCRAFT - VOL 1', NASA CR-145369.
- [12] J. Polinski, 'Materials in cryogenics Jaroslaw Polinski', presented at the European course in cryogenics, Geneva, CERN, 2010.
- [13] D. Verstraete, 'The Potential of Liquid Hydrogen for long range aircraft propulsion', PhD Thesis, CRANFIELD UNIVERSITY, 2009.
- [14] CRYOPLANE, 'Liquid Hydrogen Fuelled Aircraft – System Analysis - FINAL TECHNICAL REPORT', Airbus Deutschland GmbH, GRD1-1999–10014.
- [15] D. Silberhorn, G. Atanasov, J.-N. Walther, and T. Zill, 'ASSESSMENT OF HYDROGEN FUEL TANK INTEGRATION AT AIRCRAFT LEVEL', presented at the Deutscher Luft- und Raumfahrtkongress 2019, Sep. 2019. [Online]. Available: <https://elib.dlr.de/129643/>
- [16] G. Corchero and J. L. Montañés, 'An approach to the use of hydrogen for commercial aircraft engines', *Proceedings of the Institution of Mechanical Engineers, Part G: Journal of Aerospace Engineering*, vol. 219, no. 1, pp. 35–44, Jan. 2005, doi: 10.1243/095441005X9139.
- [17] D. Verstraete, 'On the energy efficiency of hydrogen-fuelled transport aircraft', *International Journal of Hydrogen Energy*, vol. 40, no. 23, pp. 7388–7394, Jun. 2015, doi: 10.1016/j.ijhydene.2015.04.055.
- [18] Scholz, Dieter, 'Design of Hydrogen Passenger Aircraft – How much “Zero-Emission” is Possible?', Nov. 2020, doi: 10.5281/ZENODO.4301104.
- [19] D. Debney *et al.*, 'FlyZero-Zero-Carbon-Emission-Aircraft-Concepts'. Aerospace Technology Institute - FlyZero, Mar. 2022.
- [20] J. Mukhopadhaya and D. Rutherford, 'Performance analysis of evolutionary hydrogen-powered aircraft', in *ICC White Paper*, 2022.
- [21] W. Lammen, B. Peerlings, E. van der Sman, and Jo. Kos, 'Hydrogen-powered propulsion aircraft: conceptual sizing and fleet level impact analysis', presented at the 9th EUROPEAN CONFERENCE FOR AERONAUTICS AND SPACE SCIENCES (EUCASS), Lille, Jul. 2022.
- [22] G. Onorato, P. Proesmans, and M. F. M. Hoogreef, 'Assessment of hydrogen transport aircraft: Effects of fuel tank integration', *CEAS Aeronaut J*, vol. 13, no. 4, pp. 813–845, Oct. 2022, doi: 10.1007/s13272-022-00601-6.