



HAL
open science

CASIMIR: system-level testing for electronics equipment in D&D operations

J Favrichon, A Urena-Acuna, J Seyssaud, P A Robin, A Ballier, T Maraine, T
Garnier, F Saigné, J Boch

► **To cite this version:**

J Favrichon, A Urena-Acuna, J Seyssaud, P A Robin, A Ballier, et al.. CASIMIR: system-level testing for electronics equipment in D&D operations. DEM 2024 – International Conference on Decommissioning Challenges Avignon, France, May 2024, Avignon, France. hal-04776911

HAL Id: hal-04776911

<https://hal.science/hal-04776911v1>

Submitted on 12 Nov 2024

HAL is a multi-disciplinary open access archive for the deposit and dissemination of scientific research documents, whether they are published or not. The documents may come from teaching and research institutions in France or abroad, or from public or private research centers.

L'archive ouverte pluridisciplinaire **HAL**, est destinée au dépôt et à la diffusion de documents scientifiques de niveau recherche, publiés ou non, émanant des établissements d'enseignement et de recherche français ou étrangers, des laboratoires publics ou privés.

CASIMIR: system-level testing for electronics equipment in D&D operations

J. Favrichon^{1*}, A. Urena-Acuna¹, J. Seyssaud¹, P.A. Robin², A. Ballier², T. Maraine³, T. Garnier³, F. Saigné³, J. Boch³

¹ CEA, DES, ISEC, DPME, LNPA, Univ. Montpellier, Marcoule, France

² ISYMAP society, France

³ Université de Montpellier, IES-UMR UM/CNRS 5214, France

* Corresponding Author, E-mail: julien.favrichon@cea.fr

KEYWORDS: *Decommissioning, System-Level methodology, Total Ionizing Dose*

Introduction

Nuclear decommissioning missions involve the use of electronic equipment for various purposes (monitoring, inspection, remote operation, etc) in harsh environments, such as ionizing radiation. On D&D worksites, gamma radiation is the most representative radiological environment. This type of radiation has a cumulative effect on electronics, known as Total Ionizing Dose (TID), and can lead to electrical and functional degradation, or even total failure of electronic systems. Hence, these systems must be evaluated to determine their tolerance to these conditions and their availability during their mission.

Electronic systems based on commercial off-the-shelf (COTS) components offer a clear advantage over hardened components in terms of cost, performance and implementation time, if the system environment (irradiation level) and intended use (exposure time) are compatible with the tolerance of these electronic systems.

Some test methodologies (MIL-STD-1019 method 883, ESCC standard 22900, JEDEC standard JEP133C 1/10) are well known to characterize electronic devices under ionizing radiation. But they only focus on elementary components such as semiconductors and transistors. However, the problems of traceability and circuit design for COTS-based electronic components and systems require a specific system-oriented approach. So, new test methodologies must be developed for the evaluation of electronic systems in irradiating environments. This will enable us to identify the most tolerant technologies in irradiating environments, and also to determine which sub-functions are the most sensitive in an electronic system.

In this context, the CASIMIR project (CASemate for Irradiation in Montpellier for Industry and Research) was initiated. This 3-year project (2021 -> 2024), financed by the French Occitanie region, involves 3 partners: CEA, IES and ISYMAP, with the aim of developing system-oriented test methodologies for assessing electronic in a nuclear environment representative of D&D worksites.

In this work, we present the first steps of a system-level qualification methodology for various devices (sensors, SD cards, Single Board Computer (SBC), camera...) based on Commercial-Off-The-Shelf (COTS) components subjected to TID [1] [2]. We will also present the PRESERVE platform [3] used to carry out these experiments.

Experiments

As part of the CASIMIR project, several experiments were carried out to measure the response to the TID of COTS devices. Several electrical and functional parameters of the systems were characterized before, during and after irradiation, and under different biasing conditions for some components. The test setups were developed according to the system to be studied, to be able to extract the most relevant parameters for characterizing their electrical and functional responses under irradiation.

For example, during sensor tests, the consumption current was monitored using a Keysight N6705C power analyzer. A Nvidia Jetson-nano card (a SBC) was used to implement a benchmark program and manage communication with the device under test (DUT) or to acquire signal [1] (Figure 1).

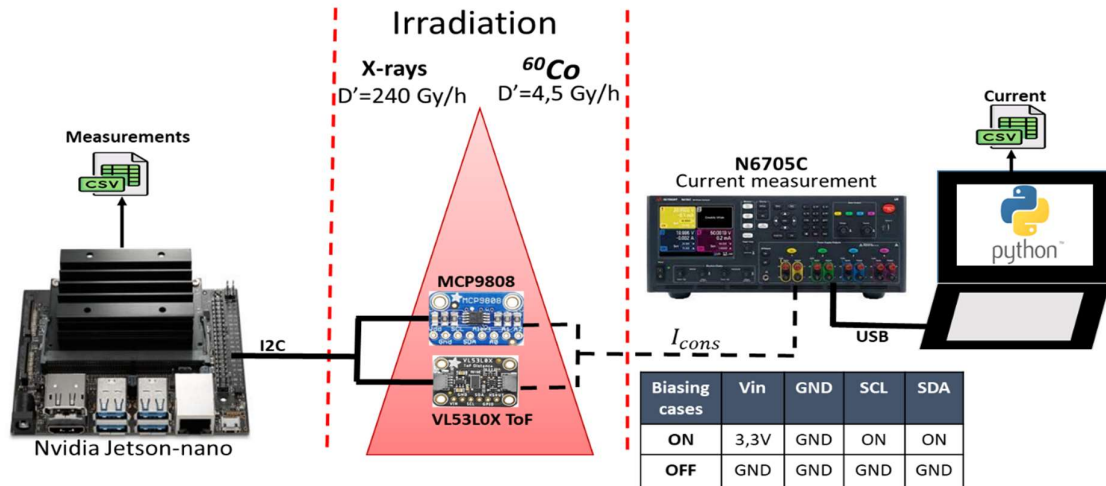

Figure 1 - Experimental setup: MCP9808 temperature and VL53L0X ToF (Time of Flight) distance sensors

We propose a system-level testing methodology based in the process depicted in Figure 2.

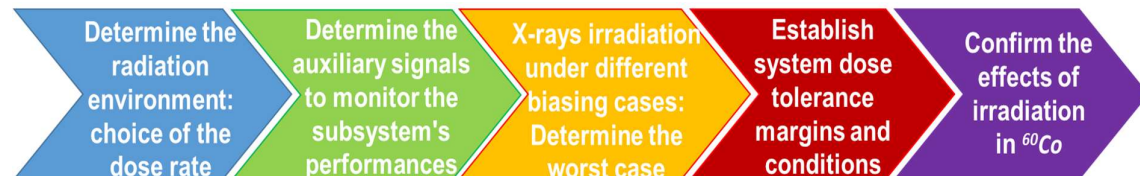

Figure 2 - System-level testing process

We have seen that the predominant failure effect in D&D site environments is related to TID linked to gamma radiation. To assess the tolerance of components and electronic systems to TID, we use X-rays and gamma irradiators.

To achieve this, the PRESERVE¹ platform test facilities available at IES [3] (Figure 3) offers the following irradiation solutions:

- high-energy X-ray generator : photons with energies up to 320 keV and a maximum dose rate of 15 rad(Air)/s (540 Gy(Air)/h),
- ⁶⁰Co gamma irradiator with a 60 Ci source (4.5 Gy/h max).

The high dose rate of the X-ray generator enables rapid testing of different electronic devices or sub-systems in different configurations, allowing rapid initial screening of sensitive parts and an initial estimate of the dose level leading to failure. In addition to its ease of use (safety and security issues are more easily managed with an X-ray generator than with radioactive sources), such an X-ray generator saves time when evaluating the dose of electronic components or systems. The ⁶⁰Co irradiator (recommended by many test methodologies) is currently used to validate the results obtained with the X-ray generator, as differences may exist due to the lower photon penetration of the X-ray generator. Work is in progress to establish equivalence between a high-energy X-ray generator and a ⁶⁰Co source [4, 5],

¹ Plateforme pour l'Etude des effets des Rayonnements ionisants sur l'Electronique

to assess dose tolerance without using the ^{60}Co irradiator, and consequently dispense with the last step shown in figure 2.

The observable signals and measurements of the device under test (DUT) can be monitored in operando by connecting them to instruments and acquisition systems located out of the irradiation field (Figure 4).

Furthermore, Single Event Effect (SEE) is another failure effect caused by interaction between the semiconductor of an electronic component and a single particle (alpha, neutron, proton, or heavy-ion). The resulting effects can range from a change of state of a memory cell called Single Event Upset (SEU) to the destruction of the component by a Single Event Latchup (SEL)). The sensitivity of a component to this type of effect can be assessed using a 1-photon laser source. This instrument offers an interesting cost/availability advantage over the large instruments traditionally used to assess SEE (heavy ion, proton, and neutron are generally provided by a particle accelerator). The SEE will be no more investigated in this paper.

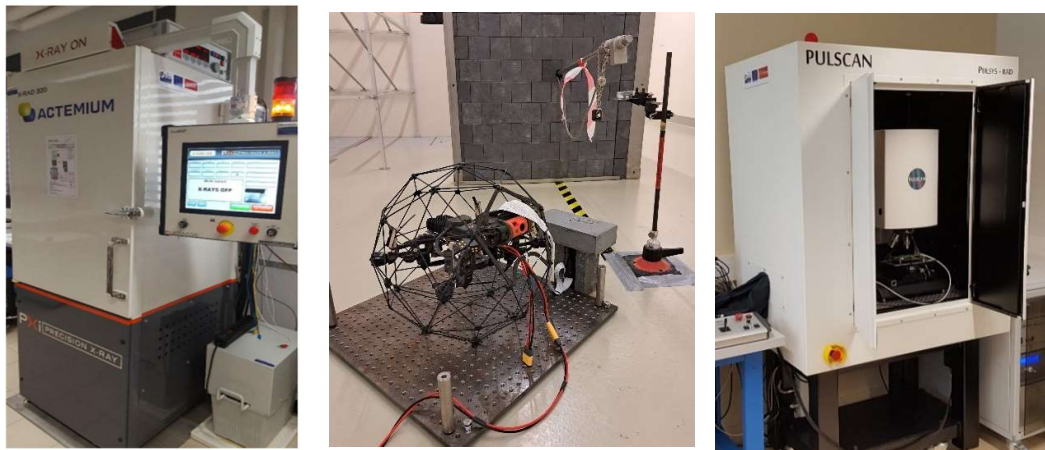
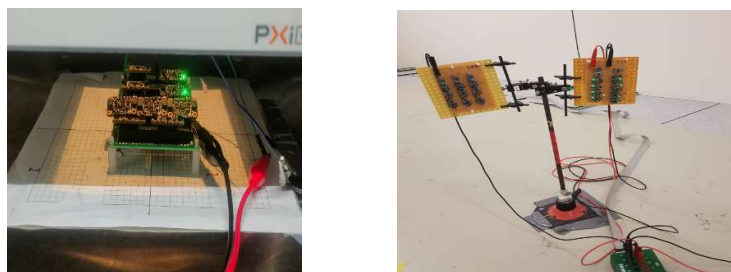

Figure 3 - PRESERVE platform equipment: X-ray generator, ^{60}Co gamma irradiator and 1-photon pulsed laser source



a) X-rays irradiation of electronic systems b) ^{60}Co irradiation of electronic systems

Figure 4 - Device under test (DUT) in the X-ray irradiator and ^{60}Co irradiator

As part of the CASIMIR project, the following devices were evaluated under X-ray and/or gamma irradiation:

- temperature, distance (ToF), inertial and environmental sensors,
- Li-ion batteries,
- storage devices (SD memory cards and SSD disks),
- 360° camera,
- Drone : Unmanned Aerial Vehicle (UAV),
- Nvidia Jetson Nano card (a SBC).

In this paper we present the synthesis of some of these tests.

Results

Sensors

An embedded robot-type inspection system in a nuclear environment requires multiple sensors to move around and measure its environment. Simultaneous localization and mapping (SLAM) functionality, for example, requires both distance and 3D orientation measurements. In this context four sensor references were chosen: the VL53L0X time-of-flight (ToF) distance sensor (ST Microelectronics), the MPU6050 inertial sensor (TDK InvenSense), the MCP9808 temperature sensor (Microchip Technology), and the BME680 environmental sensor (Bosch) (Figure 5).

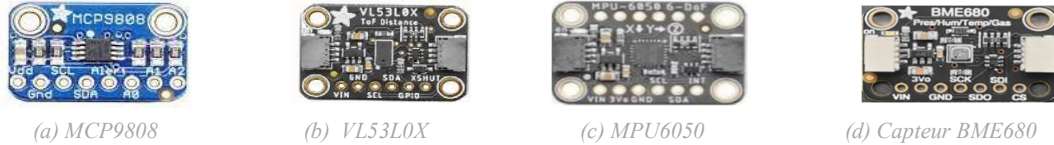

Figure 5 - Tested sensors

The applied dose rate is 240 Gy (SiO₂)/h under high energy 320 keV X-ray radiation. We use a 2 mm aluminum filter to eliminate lower-energy photons and be more representative of gamma radiation [4]. For ⁶⁰Co gamma irradiation, the dose rate is 4.5 Gy/h.

To evaluate these sensors, we used three criteria:

- communication with the SBC must be possible,
- 10% of tolerance in measurement accuracy,
- A Current consumption lower than the maximum current specified in the component datasheet, in order to maintain system reliability and autonomy as far as possible.

We define the dose tolerance as the dose limit above which at least one of these three criteria is not met. Table 1 [1] shows the dose performance of the various tested sensors.

Table 1 - Dose tolerance of tested sensors

Sensor	Dose tolerance (Gy)		Worst case of polarization
	ON	OFF	
MCP9808	120 Gy L1 155 Gy L2	240 Gy L1 480 Gy L2	ON
VL53L0X	480 Gy L1 3000 Gy L2	>3000 Gy L1 and L2	ON
MPU6050	600 Gy L1 800 Gy L2	1250 Gy L1	ON
BME680	>2000 Gy	>3000 Gy	ON

The results indicates that the "ON" biasing case is the worst case when using these types of sensors during a mission in an irradiating environment. This is well known in the literature [6], where the application of an electric field during irradiation prevents the initial recombination of charges in transistor oxides, producing greater electrical degradation of device performance. This phenomenon must be taken into account, as it represents use in real-life conditions, i.e. when the system is powered.

Storage devices

SD cards are widely used as data storage devices in embedded systems such as 3D scanners, drones, SBC and so on. Portability, low power consumption and performance make these devices suitable for embedded systems.

There are various types of industrial NAND Flash memory:

- SLC (Single Level Cell) flash memory. There are only two potential storage states, either logic "0" or logic "1",
- MLC (Multi Level Cell), flash memory with multi-level cells,
- TLC (Triple-level cell) flash memory with three cells.

During the experiments, we observed various types of failure mechanisms [2]. We have divided them into two categories:

- Category 1: devices show low performance degradation and minor variation in their current profile. A total system failure occurs unexpectedly, which we can call an "all-or-nothing" failure. As an example, the Transcend 16 GB SD cards (Figure 6) correspond to category 1.
- Category 2: the device operates correctly during a TID interval. A variation in performance is noticed as its current profile changes. In addition, the current consumption increases progressively as the absorbed dose increases. Irradiation results for Hama 32GB SD cards (Figure 7) correspond to category 2.

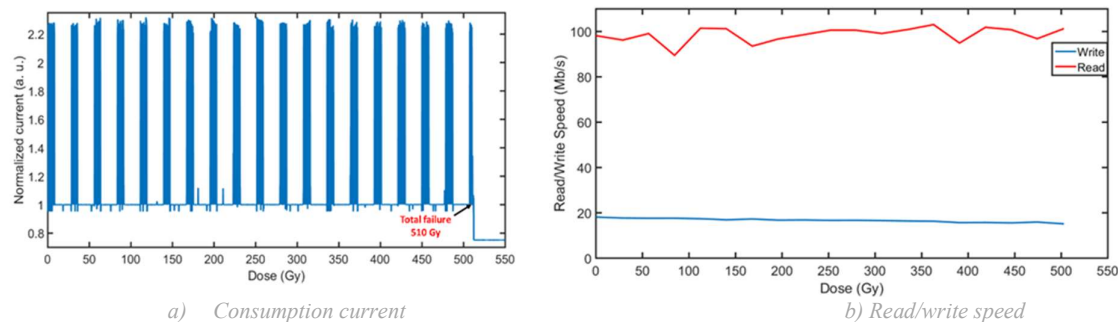

Figure 6 - Transcend 16 GB SD card - Correlation between current consumption and read/write speeds

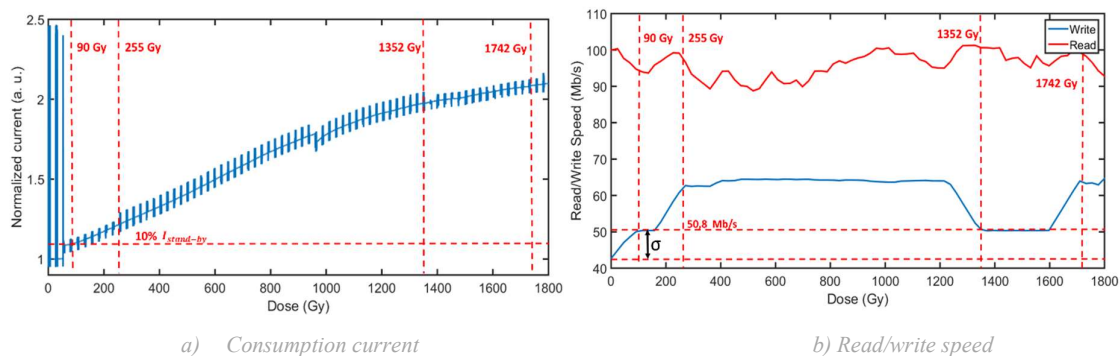

Figure 7 - SD Hama 32 Go card - Correlation between current consumption and read/write speeds

Excessive increases in current can lead to wide variations in writing speeds. For these reasons, it may be worth considering current consumption as a parameter for assessing tolerance to ionizing radiation for this type of device. We find that an increase of between 8% and 10% produces a standard deviation (σ) change in write speed [2] as observed in Figure 7 b).

Based on the behavior of the device under ionizing radiation, we consider the maximum acceptable dose level (or tolerance threshold) as the value where the first of the following failure modes is reached:

- a) Degradation of R/W speeds: a device undergoing irradiation showing a variation greater than one standard deviation (σ) compared to the average of non-irradiated devices.
- b) Significant increase in consumption current: a current increase of 10% of the standby current.
- c) A total device failure.

The results of the devices tested are shown in the Table [2].

Table 2 - Irradiation results and failure categories for SD and SSD cards

Manufacturer	Capacity (Gb)	Reference	Type	Number of tested devices (X-rays)	Number of tested devices (^{60}Co)	Failure mechanism category	Average Total failure Dose for X-rays and ^{60}Co (Gy)	Average Qualified Dose resistance for X-rays and ^{60}Co (Gy)
Hama	16	00124150	MLC	5	2	2	400	200
	32	00124151	MLC	5	2	2	1100	135
	64	00124152	MLC	5	2	1	88	88
Transcend	8	TS8GUSDHC10U1	MLC	5	2	2	1420	645
	16	TS16GUSDCU1	MLC	5	2	1	480	470
	32	TS32GUSDHC10	MLC	5	2	2	240	213
	64	TS64GUSD300S-A	3D-MLC	5	2	1	103	103
Delkin	0.5	SE51TLNFX-1D000-3	SLC	3	2	2	276	321
	1	SE0GTLNFX-1D000-3	SLC	3	2	2	241	252
	16	USDCOEM-16GB	3D-MLC	5	2	1	97	97
	32	SE32FQYFA-1B000-3	TLC	3	2	1	613	613
	32	USDCOEM-32GB	3D-MLC	5	2	1	101	101
Scandisk	32	SDSQUA4-032G-GN6MA	MLC	4	2	1	60	60
	64	SDSQXA2-064G-GN6MA	MLC	4	2	2	240	175
	128	SDSQXA1-128G-GN6MA	MLC	4	2	2	419	274
Swissbit	0.5	SFSD0512N1BNI	SLC	3	2	2	83	62
Transcend SSD	240	ESD240C	3D-MLC	4	1	2	150	92
	250	ESD270C	3D-TLC	4	1	2	210	98

Li-ion batteries

A key component in the autonomy of on-board systems is the battery. Modern batteries are based on lithium and electrolytes of various types. A cell is made up of four blocks: a cathode, an anode, a separator and an electrolyte. In addition, an electronic circuit called Battery Management System (BMS), manages the charging and discharging and optimizes battery capacity using the CC-CV (Constant Current-Constant Voltage) algorithm [7].

In this experiment, we irradiated several LP103450 3.7 V 1800 mAh Li-Ion batteries with high energy X-rays with a dose rate of 10 Gy (SiO_2)/h. The electrical degradation found in the state of the art focuses on electrolyte degradation [8, 9], and in some cases, no biasing was applied (charge/discharge cycle). In our case, we test the battery as close as possible to a real-life situation, i.e., by performing charge/discharge cycles while the batteries are exposed to ionizing radiation. Thus, as observed in Figure 8, the batteries showed a progressive loss of capacity as the dose level increased. The nominal capacity was measured before irradiation at 3.76 V. At the end of the experiment, the capacity was measured at 2.93 V after a dose level of 84 Gy. This is due to the degradation of the S-8261 circuit in the BMS, which depends in a series of comparators to detect when the charge is complete as observed in the datasheet [10]. The full charge detection threshold shifts as the dose level increases. In consequence, the charge is not completed, and the battery stores less charge.

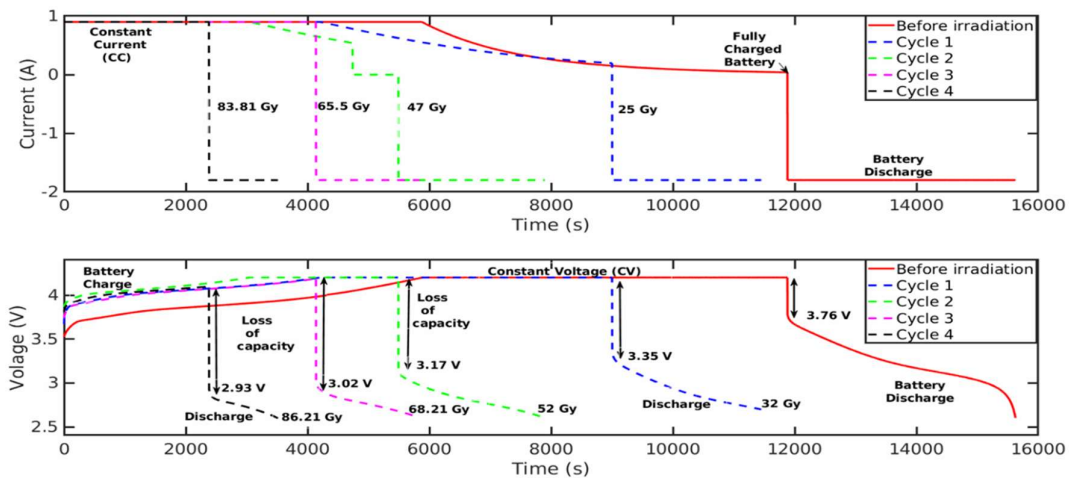

Figure 8 - CC-CV algorithm for several dose levels

The electrical degradation of a Li-ion battery could be problematic under a harsh radiation environment, having a strong impact on a system's autonomy.

360° camera

360° cameras find applications in inspection operations in harsh nuclear environments [11]. The aim of this evaluation was dual. Firstly, determine the device's ability to reconstitute a 360° image in an irradiating environment. Secondly, identify the dose at which the device's sub-functions fail.

The Ricoh theta 360° camera [12] was positioned in the ⁶⁰Co gamma irradiator for a dose rate of 1 Gy/h. The battery was replaced by a N6705C power analyzer to power the camera and measure current consumption during the experiment. Functional monitoring of the camera was carried out by taking a 10-second video and a photo (10 MB) every 30 minutes (Figure 9). All images and videos were stored in an external SSD outside the irradiation chamber. All data was saved in a CSV file for post-processing.

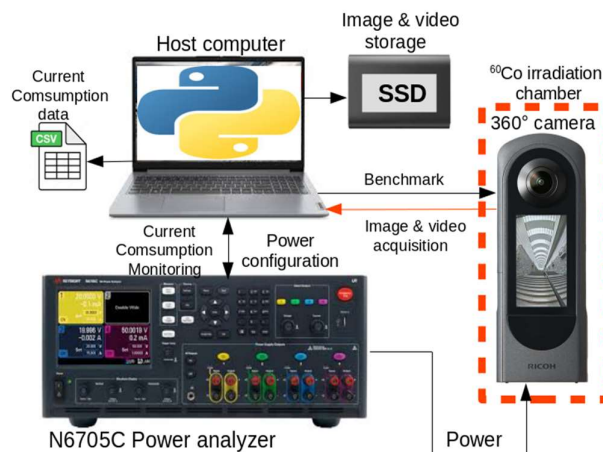

Figure 9 - Experimental setup for testing the 360° camera

Under these experimental conditions, the device remained functional up to a cumulative dose of 154 Gy (Figure 10). Between 155 Gy and 180 Gy a variation in the current consumption is noticed. The communication between the camera and the host computer was interrupted leading to a functional failure. The remained consumption current (between 155 and 180 Gy) corresponds to the operation of the screen of the camera. A total failure was observed beyond 180 Gy.

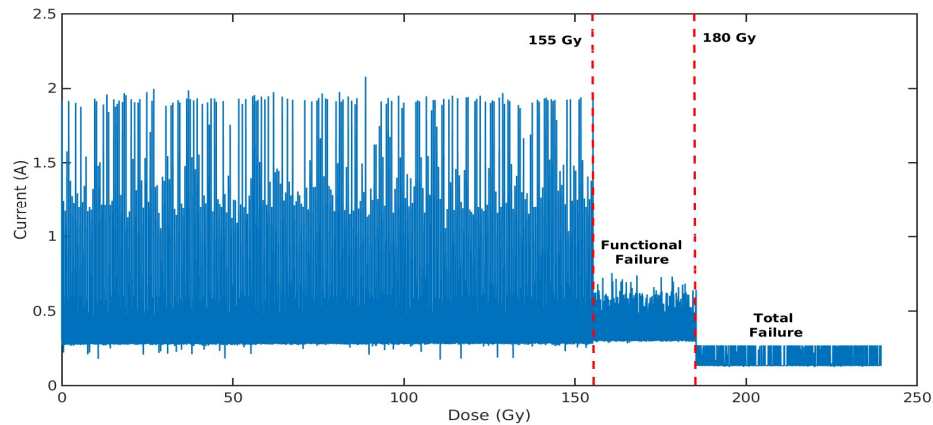
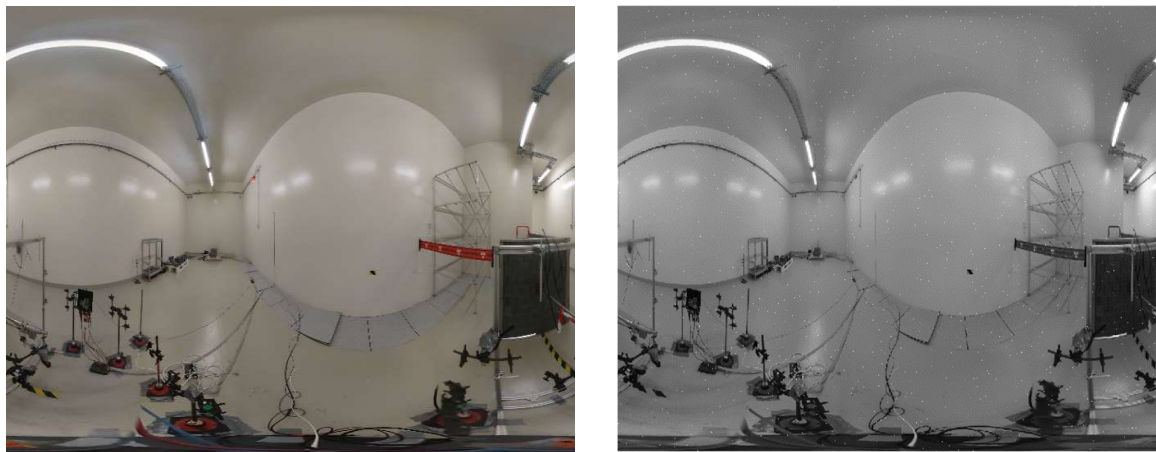

Figure 10 - Consumption current monitoring of the 360° camera as function of the absorbed dose



a) Image before irradiation

b) image after 155 Gy in gray scale

Figure 11 - Images before and after irradiation of the Ricoh Theta 360° camera

We observe in Figure 11. the images taken before irradiation and at the end of the experiment. For practical purposes we transform the irradiated image in a gray scale to better observe the degraded image. In Figure 11 b), we observe an increase of 82% in white pixels (salt-pepper noise). This is due to the CMOS imagers degradation [13,14]. The 360° reconstruction algorithm did not show disturbances.

Unmanned Aerial Vehicle

Unmanned Aerial Vehicle (UAV) are an innovative visual inspection tool for operations in complex terrain (height, cluttered or rough ground, etc.). Flight tests have been carried out in 2022 and 2023 to verify the technical and administrative feasibility of using these devices in nuclear facilities (without any significant ionizing radiation constraints for the electronics), and to assess their capabilities [15].

To determine the UAV's tolerance to irradiation, tests were carried out as part of the CASIMIR project. Irradiations were carried out using the ^{60}Co irradiator (Figure 12 a)) and a dose rate of 1 Gy/h.

During irradiation, two types of monitoring are performed:

- Continuous check: the control interface (Figure 12 b)) is permanently connected to the UAV via the Wi-Fi transmitter, and monitors the main on-board sensors and functions (communication,

power, storage, sensors, motors, etc.), thus checking its status. Power supply voltage and current are also monitored, as increased current consumption is a common sign of electronic failure due to radiation.

- Spot check: once or twice a day, a motor start-up test is carried out from the control room, to check motor operation (the UAV is attached to a metal plate for safety purposes, making it impossible to move inside the irradiator room).

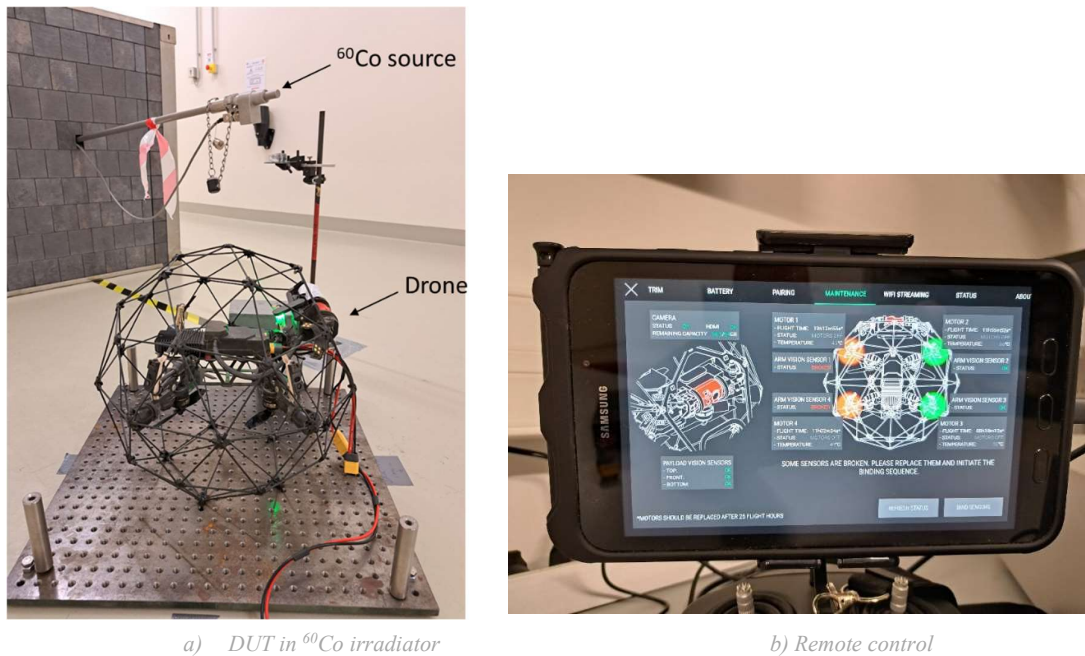

Figure 12 - UAV testing setup

These irradiation tests showed that the equipment was tolerant to irradiation up to 195 Gy. This represents 179 hours with a dose rate of 1.09 Gy/h at the center of the UAV. The major failure concerned the loss of communication between the drone and the control unit, rendering the equipment inoperable.

Regarding the distance sensors used for automatic stabilization, the 2 sensors closest to the ^{60}Co source failed at a cumulative dose of between 200 and 250 Gy.

We note a significant increase in consumption current (excluding take-off) until the 1st failure, from 0.54 A to 0.72 A, i.e. $\sim 33\%$. The consumption current then stabilizes at 0.70 A until the major failure. Monitoring current consumption could be an indicator of the device's "state of health".

Jetson Nano

The Jetson-nano Single Board Computer (SBC) is an NVIDIA product [16] designed to implement solutions based on IoT (Internet of Things) and AI (Artificial Intelligence) thanks to its GPU. Its attractive performance/consumption ratio makes it a device of choice for embedded systems. To date, very few studies have been carried out to assess the radiation tolerance of this device [17]. So, as part of the CASIMIR project, we assessed the SBC's overall TID tolerance, taking into account both hardware (I/O interface) and software (ability to execute a program) functional aspects. To test the various I/O ports during irradiation, sensors and peripherals were connected:

- USB: USB key (storage)
- I2C: MCP9808 temperature sensor
- SPI: ST7735 display
- CSI: Raspberry V2.1 camera
- Ethernet: computer connected by RJ45

The GPU was tested for radiation tolerance using an AI object recognition algorithm. As the tolerance evaluation was carried out on Jetson boards only, all peripherals and the SD card hosting the operating system were either protected from ionizing radiation by a lead shield, or located outside of the irradiation field.

The gamma irradiation was carried out in the ^{60}Co irradiator with 2 campaigns of 3 Jetson Nano Developer Kit 4GB RAM cards at a dose rate of 1Gy/h (Figure 13).

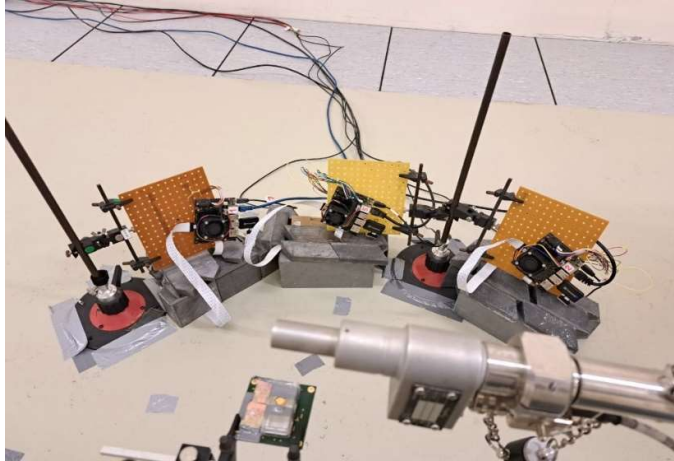

Figure 13 - Jetson Nano testing setup in in ^{60}Co irradiator

These first experiments show that the cards have an average TID tolerance of 265 Gy. The different interfaces did not show any malfunction until the final system failure. These initial results require further investigation, including the influence of the dose rate level on this tolerance.

Conclusion and perspectives

System-level testing and the use of COTS components in irradiation environments are emerging topics of interest to many stakeholders. The irradiation experiments carried out during the CASIMIR project demonstrated the ability of the PRESERVE platform to test COTS-based devices with appropriate monitoring.

In all the studies carried out, we found a generally similar relationship between an increase in consumption current and functional failure of the device. Thus, an increase in consumption current may be an indicator of an imminent failure. Nevertheless, some systems (e.g. certain storage devices) differ from others in that they do not show any significant current variation or performance degradation prior to failure. This is why it is so important to identify these devices, which deviate from the general behavior.

These studies have also shown that irradiation of devices in biased mode (powered) more sensitive in terms of tolerance to ionizing radiation (X-rays and gamma).

Batteries (Li-ion) showed a progressive loss of capacity as a function of cumulative dose. The effect of ionizing radiation also has an impact on the power consumption of an electronic device, which can affect the autonomy of an embedded system.

The variability of system components from one lot to another (lot-to-lot variability) - was observed during the sensor study. As component traceability is a complex issue for COTS-based systems, strategies need to be studied to take this problem into account in the test methodology.

The study carried out in this project represents the first steps in the development of a system test methodology. This work enables us to establish a number of general rules:

1. Determine the target usage environment to define in particular the type of radiation and the dose rate.
2. Analyze the system to be tested and determine observables to monitor performance (parametric and functional). This allows the identification of radiation-sensitive subsystems.
3. Irradiate the devices with an X-ray generator under different polarization conditions to determine the worst-case scenario. This allows the fastest monitoring of degradation.
4. Establish system dose margins and tolerance conditions before failure. The proposed criteria are as follows:
 - communication with the system,
 - a tolerance on functionality :
 - 10% in measurement accuracy for a sensor,
 - Variation greater than one standard deviation (σ) from the mean of pre-irradiation measurements (in the case of storage devices),
 - current consumption below the recommended maximum current, or a significant increase in current consumption (>10% of standby current),
 - total device failure.
5. Until an equivalence between high energy X-rays generator and cobalt irradiator is shown, confirm the effects of X-irradiation using a ^{60}Co source (gamma irradiation).

The evaluation of electronic components and systems enables us to identify which technologies are most tolerant to irradiating environments, and also to determine which sub-functions are most sensitive, in order to propose appropriate radiation-hardening techniques if necessary.

Finally, to take these studies further and propose system-level test methodologies, a PhD thesis topic entitled "Development of test methodologies for electronic systems designed for irradiating environments" has been proposed.

All this work will lead to a methodological guide on recommendations for setting up electronic systems for D&D worksites.

Acknowledgment

The authors thank the Occitanie region for funding this work within the framework of the PRRI CASIMIR project. X-rays and ^{60}Co tests were performed using the PRESERVE Platform, which was funded by the CEA, Occitanie Region and the EU.

References :

- [1] Urena-Acuna, A., Favrichon, J., Cantrel, E.,... Boch, J., System-level testing and qualification of environmental sensors for nuclear decommissioning, Animma 2023 conference
- [2] Urena-Acuna, A., Favrichon, J., Cantrel, E., ..., Boch, J , TID System-Level Testing and Qualification Methodology of COTS SD and SSD NAND Flash Memories, RADECS 2023 conference
- [3] <https://www.ies.umontpellier.fr/la-recherche-et-linnovation/equipements-et-plateformes/plateforme-technologique-preserve/>
- [4] V. Girones et al., "The Use of High-Energy X-Ray Generators for TID Testing of Electronic Devices," in IEEE Transactions on Nuclear Science, vol. 70, no. 8, pp. 1982-1989, Aug. 2023, doi: 10.1109/TNS.2023.3279626.
- [5] V. Girones et al., "Comparison of High Energy X-ray and Cobalt 60 irradiations on MOS capacitors," in IEEE Transactions on Nuclear Science, 2024, doi: 10.1109/TNS.2024.3366432
- [6] Schwank, J. R., Shaneyfelt, M. R., Fleetwood, D. M., Felix, J. A., Dodd, P. E., Paillet, P., & Ferlet-Cavrois, V. (2008). Radiation effects in MOS oxides. IEEE Transactions on Nuclear Science, 55(4), 1833-1853.
- [7] Liu, H., Naqvi, I. H., Li, F., Liu, C., Shafiei, N., Li, Y., & Pecht, M. (2020). An analytical model for the CC-CV charge of Li-ion batteries with application to degradation analysis. Journal of Energy Storage, 29, 101342.
- [8] Tan, C., Lyons, D. J., Pan, K., Leung, K. Y., Chuirazzi, (2016). Radiation effects on the electrode and electrolyte of a lithium-ion battery. Journal of Power Sources, 318, 242-250.

- [9] Qiu, J., He, D., Sun, M., Li, S., Wen, C., Hatrick-Simpers (2015). Effects of neutron and gamma radiation on lithium-ion batteries. *Nuclear Instruments and Methods in Physics Research Section B: Beam Interactions with Materials and Atoms*, 345, 27-32.
- [10] https://www.ablic.com/en/doc/datasheet/battery_protection/S8261_E.pdf
- [11] Kerkhof, Y et al., Development of a 360° video application for hostile environment investigations. DEM 2024-Dismantling Challenges: Industrial Reality, Prospects and Feedback Experien.
- [12] https://support.theta360.com/en/manual/v/content/add_info/add_info_01.html
- [13] M. K. Tiwari et al., "Comparison of gamma radiation effects on ccd cameras under different bias conditions using image analysis techniques," *IEEE Transactions on Nuclear Science*, no. 12, pp. 2297–2304, 2022.
- [14] J. Armani et al., "Enhancement of the total dose tolerance of a commercial cmos active pixel sensor by use of thermal annealing," in 2011 12th European Conference on Radiation and Its Effects on Components and Systems. IEEE, 2011, pp. 340–344.
- [15] Seyssaud, J et al., Indoor UAV for nuclear investigation, a feedback. Poster at DEM 2024-Dismantling Challenges: Industrial Reality, Prospects and Feedback Experien.
- [16] <https://www.nvidia.com/fr-fr/autonomous-machines/embedded-systems/jetson-nano/product-development/>
- [17] Slater, W. S., Tiwari, N. P., Lovelly, T. M., & Mee, J. K. (2020, September). Total ionizing dose radiation testing of NVIDIA Jetson nano GPUs. In 2020 IEEE High Performance Extreme Computing Conference (HPEC) (pp. 1-3). IEEE.