



**HAL**  
open science

## Integrating the LSST Camera

Travis Lange, Martin Nordby, Hannah Pollek, Shawn Osier, Boyd Bowdish,  
Diane Hascall, Margaux Lopez, Scott Newbry, Juan Carlos Lazarte, Gregg  
Thayer, et al.

► **To cite this version:**

Travis Lange, Martin Nordby, Hannah Pollek, Shawn Osier, Boyd Bowdish, et al.. Integrating the LSST Camera. Proceedings of SPIE, the International Society for Optical Engineering, 2024, 13096, pp.id. 130961O 24. 10.1117/12.3019302 . hal-04775095

**HAL Id: hal-04775095**

**<https://hal.science/hal-04775095v1>**

Submitted on 9 Nov 2024

**HAL** is a multi-disciplinary open access archive for the deposit and dissemination of scientific research documents, whether they are published or not. The documents may come from teaching and research institutions in France or abroad, or from public or private research centers.

L'archive ouverte pluridisciplinaire **HAL**, est destinée au dépôt et à la diffusion de documents scientifiques de niveau recherche, publiés ou non, émanant des établissements d'enseignement et de recherche français ou étrangers, des laboratoires publics ou privés.

# Integrating the LSST Camera

Travis Lange, Martin Nordby, Hannah Pollek, Shawn Osier, Boyd Bowdish, Diane Hascall, Margaux Lopez, Scott P. Newbry, Juan Carlos Lazarte, Gregg Thayer, Homer Neal, Vincent T. Lee, Michael Silva, David Kiehl, Andrew Hau, Tom Nieland, Nico Linton, David C. Shelley, Yongqiang Qiu, Mark Freytag, Stephen Cisneros, Chris Mendez, Stuart Marshall, Yousuke Utsumi, Tony Johnson, Andrew P. Rasmussen, Aaron Roodman, Steven Tether, Alan Eisner, Max Turri, Dmitry Onoprienko, Owen Saxton, James Chiang, Seth W. Digel, Andrew K. Bradshaw, Kevin A. Reil, Vincent Riot<sup>2</sup>, Justin E. Wolfe<sup>2</sup>, Scott Winters<sup>2</sup>, Brian Baumen<sup>2</sup>, William Wahl<sup>3</sup>, Paul O'Connor<sup>3</sup>, Pierre Antilogus<sup>4</sup>, Claire Juramy<sup>4</sup>, Françoise Virieux<sup>4</sup>, Alexandre Boucaud<sup>4</sup>, Camille Parisel<sup>4</sup>, Eric Aubourg<sup>4</sup>, Eric Lagorio<sup>4</sup>, Pierre Karst<sup>4</sup>, Aurelien Marini<sup>4</sup>, Didier Laporte<sup>4</sup>, Francis Vezzu<sup>4</sup>, Guillaume Daubard<sup>4</sup>, Patrick Breugnon<sup>4</sup>, Tony Tyson<sup>5</sup>, Adam Snyder<sup>5</sup>, Craig Lage<sup>5</sup>, Tim Bond<sup>6</sup>, Steve Ritz<sup>7</sup>

SLAC National Accelerator Laboratory, Menlo Park, CA, United States

<sup>2</sup>Lawrence Livermore National Laboratory, Livermore, CA, United States

<sup>3</sup>Brookhaven National Laboratory, Brookhaven, NY, United States

<sup>4</sup>Institut National de Physique Nucléaire et de Physique des Particules (IN2P3), Paris, France

<sup>5</sup>University of California Davis, Davis, CA, United States

<sup>6</sup>GMTO, Pasadena, CA, United States

<sup>7</sup>University of California Santa Cruz, Santa Cruz, CA, United States

## SUMMARY ABSTRACT

The LSST Camera is a complex, highly integrated instrument for the Vera C. Rubin Observatory. Now that the assembly is complete, we present the highlights of the LSST Camera assembly: successful installation of all Raft Tower Modules (RTM) into the cryostat, integration of the world's largest lens with the camera body, and successful integration and testing of the shutter and filter exchange systems. While the integration of the LSST Camera is a story of success, there were challenges faced along the way which we present: component failures, late design changes, and facility infrastructure issues.

**Keywords:** LSST, Camera, Integration, Test, Optics, Alignment, Project Management

## 1. INTRODUCTION

The Vera C. Rubin Observatory is an 8 m-class telescope with a very wide, 10 square-degree field-of-view that will be used to survey the southern sky from Cerro Pachon, Chile. The only planned instrument for the telescope—a 3,200-megapixel digital camera for the Legacy Survey of Space and Time (LSST)<sup>1</sup>—has been designed, constructed, and tested by several partner institutions, and led by SLAC National Accelerator Laboratory (SLAC). Integration and test of the Camera was completed in March 2024, and it was shipped to Chile in May 2024.

Cross section and exploded views of the Camera are shown in Figures 1 and Figures 2. As shown, it measures just over 1.6 m (5'3") in diameter, 4.5 m (14.8') in length with a mass of 2886 kg (6350 lb). It contains the largest contiguous array of CCDs ever assembled: 189 science grade, 4k x 4k sensors contained within a 0.64 m (25") focal plane. There are three large corrector optics: the primary (L1) is the largest lens ever made at 1.57 m in diameter, and the third (L3) doubles as the vacuum window for the Camera's cryostat. In addition, the Camera has five bandpass optical filters onboard, with a sixth that is stored offline and can be exchanged for one of the onboard filters. The process for changing one onboard filter for another takes 90 seconds, while the process for exchanging one of the onboard filters for the offline filter requires a couple of hours.

This paper will highlight the steps for planning, assembling, and testing the LSST Camera. In addition, we will highlight some of the equipment, our successes and challenges which were overcome during the 10 years of construction. For Camera characterization, we will refer to the papers by Roodman<sup>2</sup> and Utsumi<sup>3</sup>.

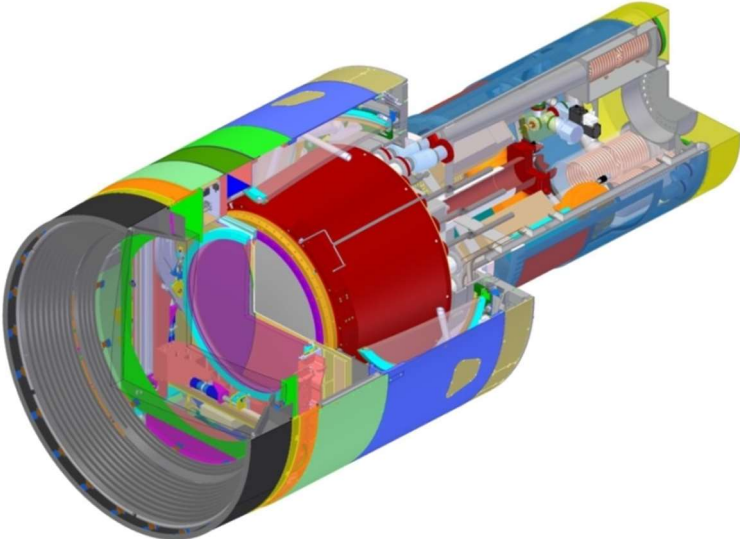

Figure 1: Cross section of LSST Camera

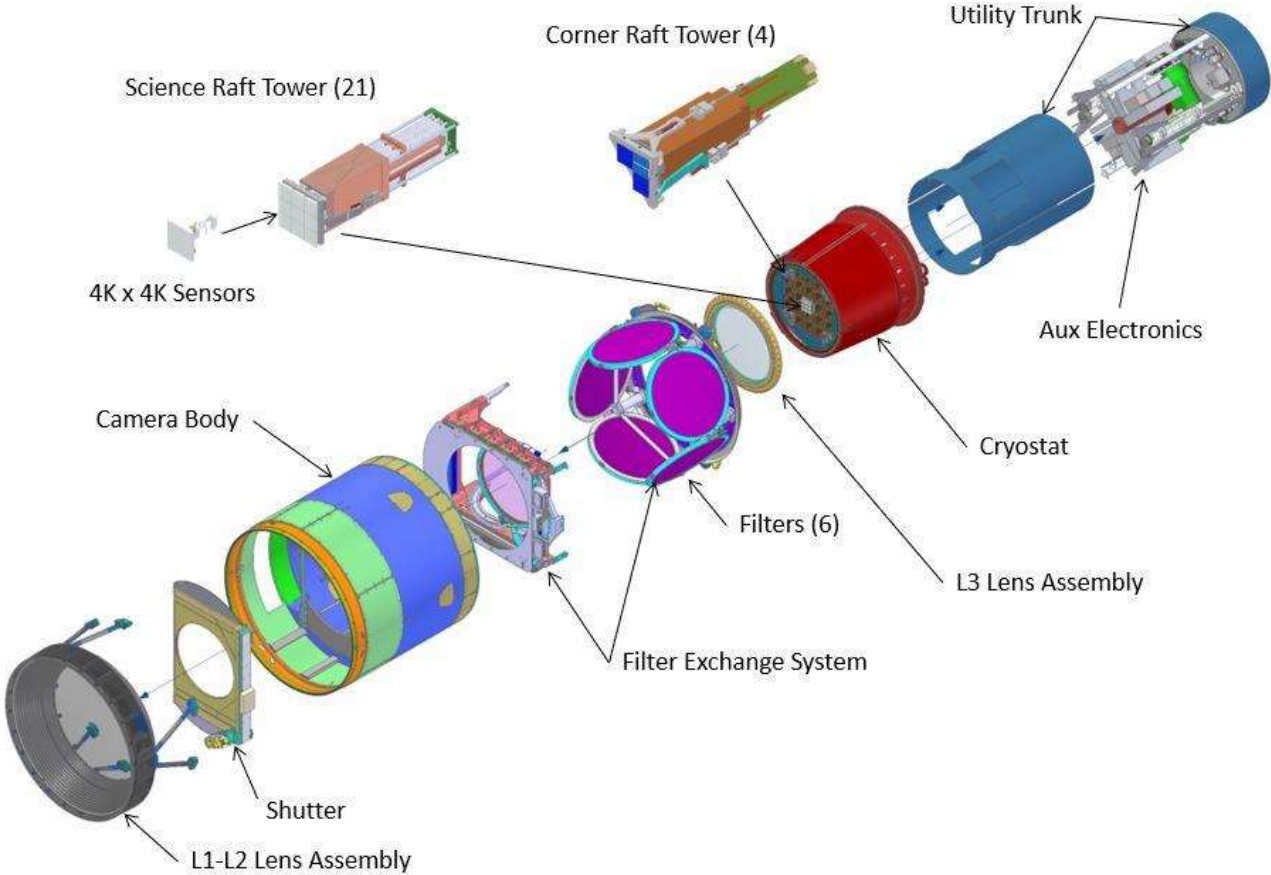

Figure 2: LSST Camera subsystems

## 2. PLANNING

The first step for any project is to make a thorough plan; this is critical for developing the order of operations, equipment requirements, resource needs and creating the budget and schedule. We will outline the basic planning process here but refer to a previous paper<sup>6</sup> which includes more details about planning of the Camera integration and test (I&T) program.

I&T's role in the LSST Camera development is to assemble and test the final Camera assembly itself. Once subsystems complete verification of their deliverables, the integration of those components into the final Camera assembly can begin. The Camera assembly follows the high-level sequences shown below in Figure 3 and Figure 4. (Note: Details have been omitted; these figures are meant to give a general overview of the process).

The integration sequence proceeds on two parallel paths for much of the initial integration effort. The work depicted in Figure 3 is intended to run in parallel with the first steps in Figure 4. These parallel integration activities converge when the fully integrated and tested cryostat is inserted into the completed camera body.

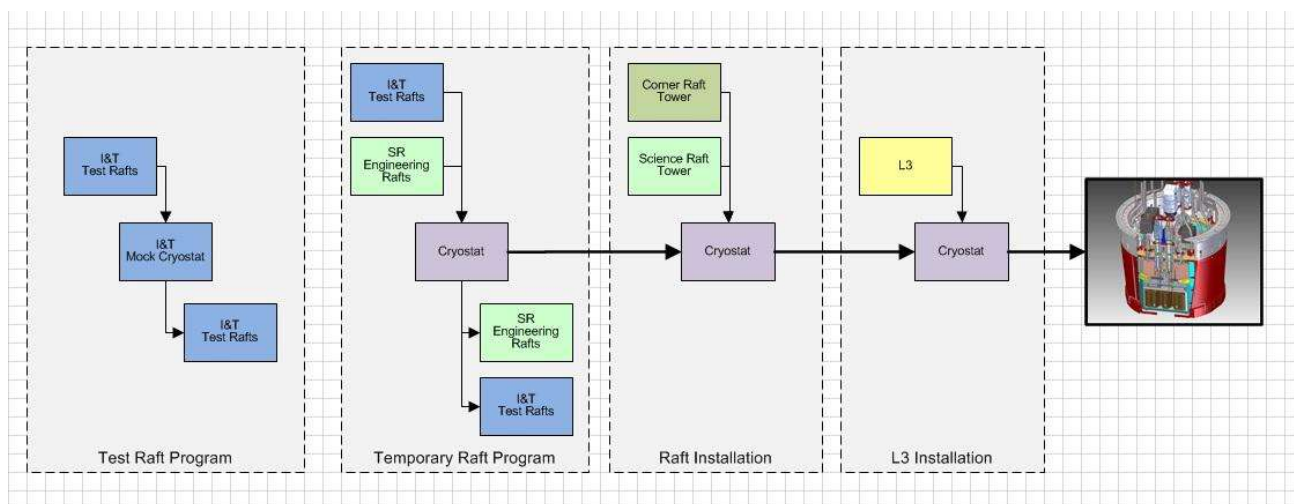

Figure 3: I&T Cryostat Integration

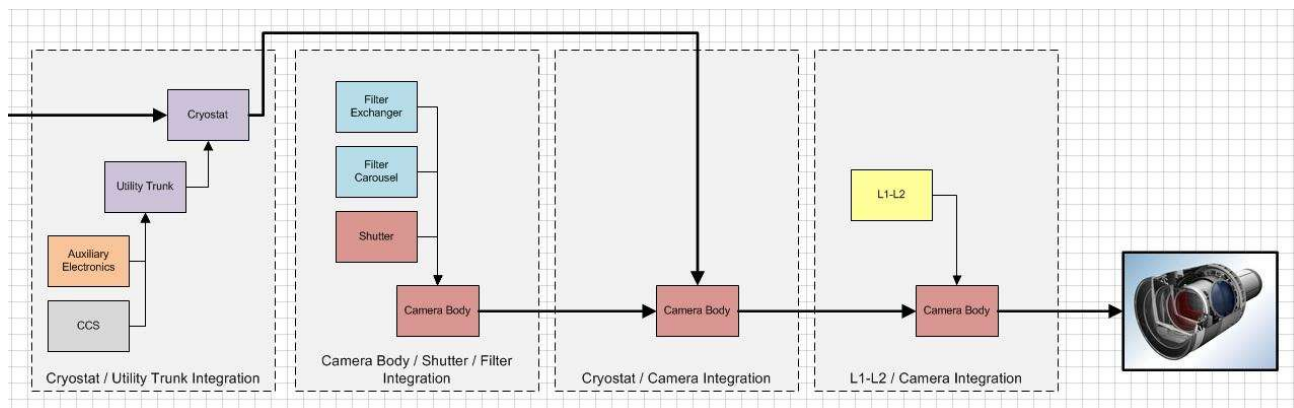

Figure 4: I&T Camera Body, Shutter and Optics Integration

I&T developed a detailed process for every step required to integrate and test the full Camera assembly. Figure 5 is just one page of the detailed integration process (meant as a visual only since the font is much too small to read in this context). Each of the boxes along the main trunk of the process flow are either an integration step (yellow border) or a verification test (red border), and each has a detailed procedure defined to accomplish the specified task. In addition, all equipment and software required to complete the task are shown in the boxes along the vertical trunks. The boxes below the main line are the support equipment required for the task, while the boxes above the main line are Camera hardware components. Additionally, the tiles are color coded to reflect which subsystem was responsible for delivering the piece of hardware or software. This format helped the I&T team identify the assembly sequence, the equipment required, when it was needed, and which subsystem was responsible for delivering it.

Once the sequence and equipment were identified, we allocated resources for each step in the flow chart. This information was used to create a schedule profile and associated cost. When linked into the master schedule, this ensured that all hardware and software required to assemble and test the Camera are planned to be available when needed.

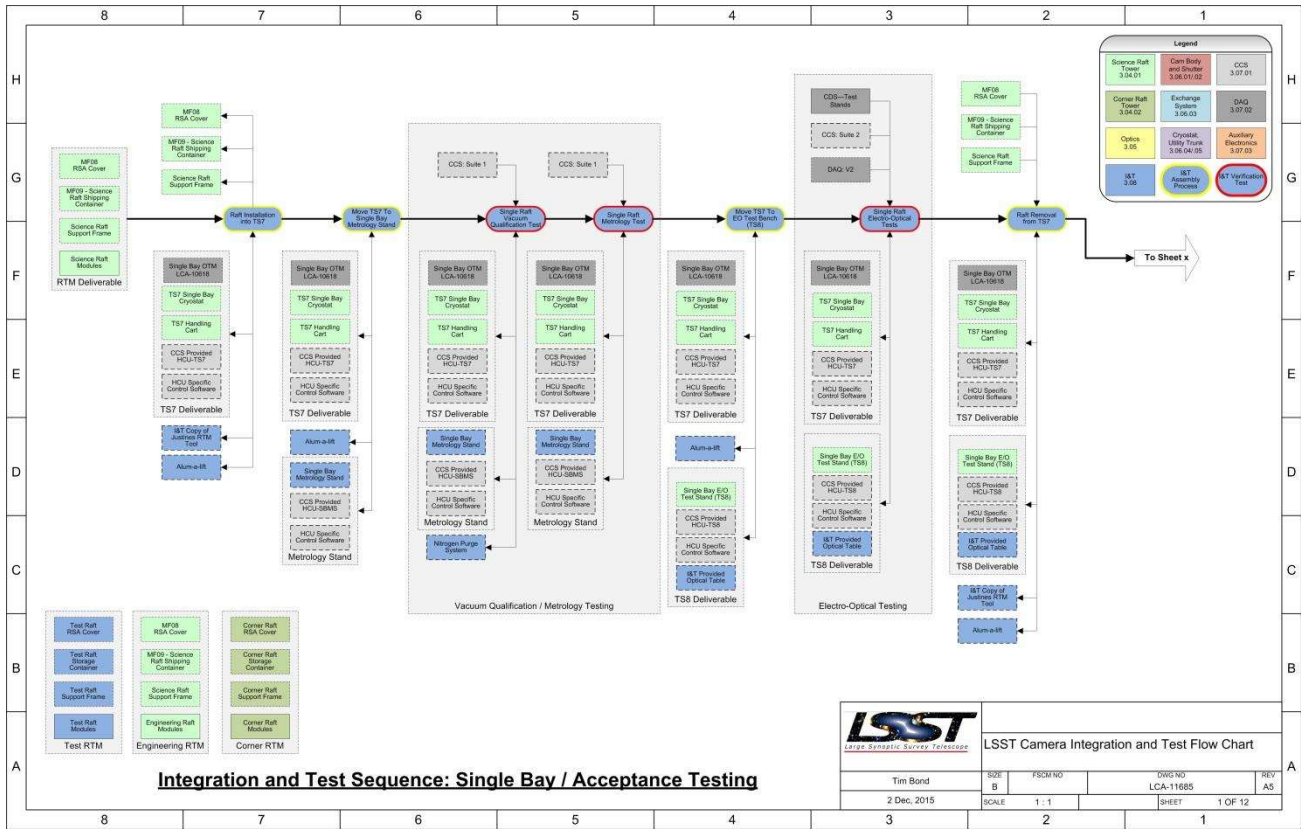

Figure 5: Single page from Integration and Test Flow Chart (details not meant to be legible)

### 3. CRYOSTAT ASSEMBLY

As noted in Figure 3 and Figure 4 above, there are two parallel paths for the overall integration sequence: the cryostat assembly and the camera body assembly. In this section, we will highlight some of the key steps of the cryostat assembly.

#### 3.1 Raft Integration Design Constraints

The most critical integration process of the cryostat involves installing the Raft Tower Modules (RTMs). The Raft Integration Stand is the mechanical device used to install the Raft Tower Modules into the cryostat. The CCDs are packaged into 3 x 3 Raft Sensor Assembly (RSA) units coupled to a Raft Electronics Crate (REC); we refer to this combined assembly as an RTM. An RTM weighs ~10 kg, is roughly 500 mm tall, and has a 126.5 mm square footprint at the CCDs. The grid array that supports the RTM in the cryostat has a center-to-center distance of 127 mm. Thus, one of the key challenges for installing the RTMs is the 500 μm gap between CCDs of adjacent modules. Due to their susceptibility to damage, avoiding contact between adjacent CCDs was a strict requirement.

I&T also had a self-imposed requirement to keep the CCD sensors always facing downward in order to minimize particulates collecting on the sensors.

Since there is no way to support the RTM from the CCD side, the interface for I&T was the top of the REC as shown in Figure 6. Due to the geometry of the camera cryostat, the process of moving an RTM from its staging position into the cryostat required a vertical motion of 600 mm. In addition, each RTM bay in the cryostat grid has a mechanical aperture of 73 mm x 95 mm as shown in Figure 7, placing further restrictions on the integration process.



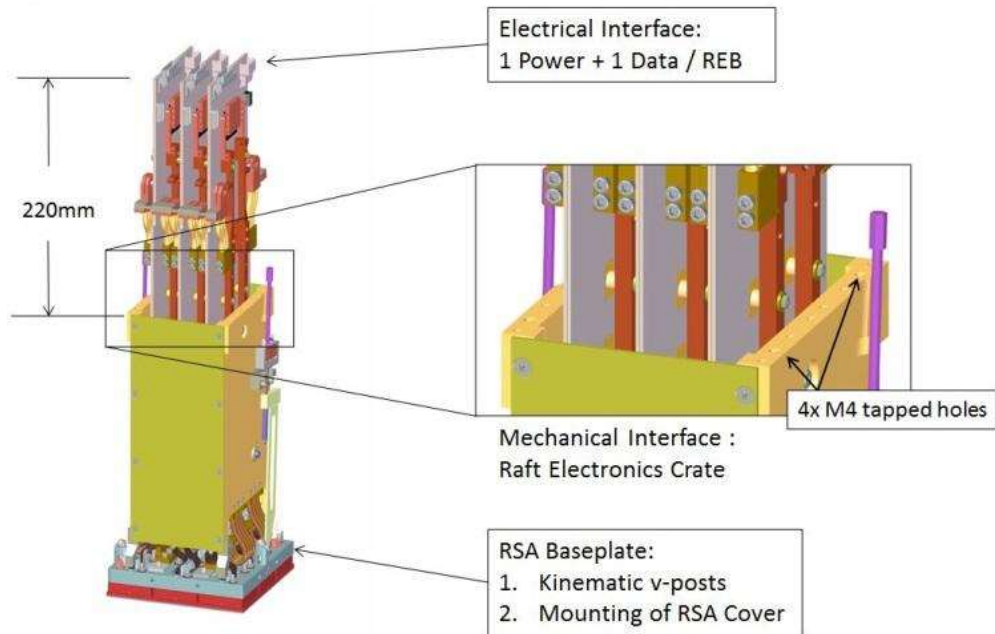
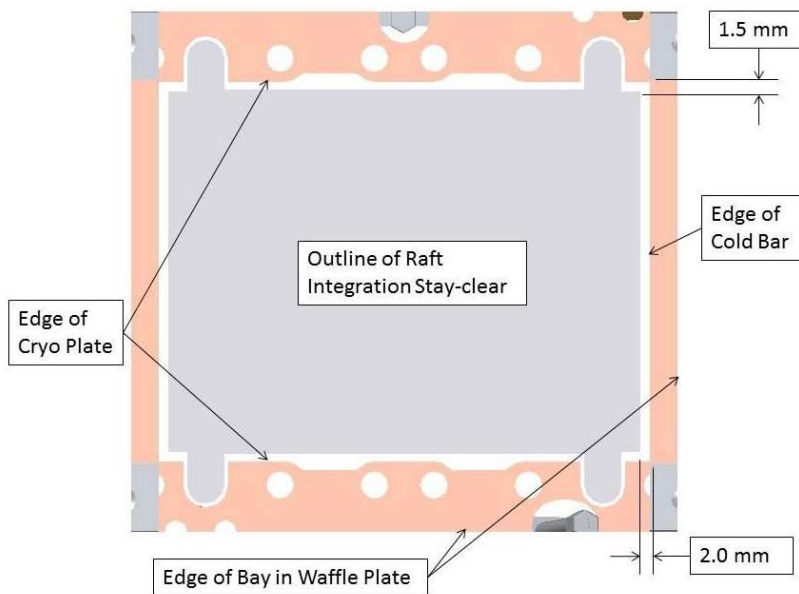

Figure 6: (4) tapped holes are the mechanical interface on science Raft Tower Module (RTM)



### 3.2

Figure 7: Vertical opening in cryostat grid bay for raft integration arm; 73 mm x 95 mm plus (4)  $\varnothing 7.5$  mm shafts

### 3.3 Raft Integration Design and Tooling

Installing an RTM into the cryostat requires access from both ends of the cryostat. Both the vacuum window (L3 lens) at the entrance to the cryostat and the vacuum bulkhead plate on the back of the cryostat need to be removed. A so-called waffle plate replaces the vacuum bulkhead plate on the back and creates a very flat and stable platform to support the raft integration stages.

A few separate assemblies are used together to draw an RTM into the cryostat: a set of stages to carry the RTM from a loading position to the correct bay under the cryostat, a set of translation and rotation axes to position a long integration arm, a vertical stage to draw the RTM up into the cryostat and a camera system for monitoring the CCD edges during the

final 35 mm of vertical motion. All integration equipment is supported on a large weldment which is the structure for the Bench for Optical Testing (BOT) and can be seen in Figure 8.

Given the long pendulum created by a 10 kg RTM on the end of a 1 m long beam, stiffness of the integration arm was important to limit any swinging motion of the RTM. The integration arm itself was made using a very stiff carbon fiber tube, but its connection to the carriage of the Z-axis stage was a limiting factor in the overall stiffness of the system. It was confirmed during initial testing, however, that the stiffness of the integration arm was sufficient for safely drawing RTMs into the cryostat without damaging any sensors.

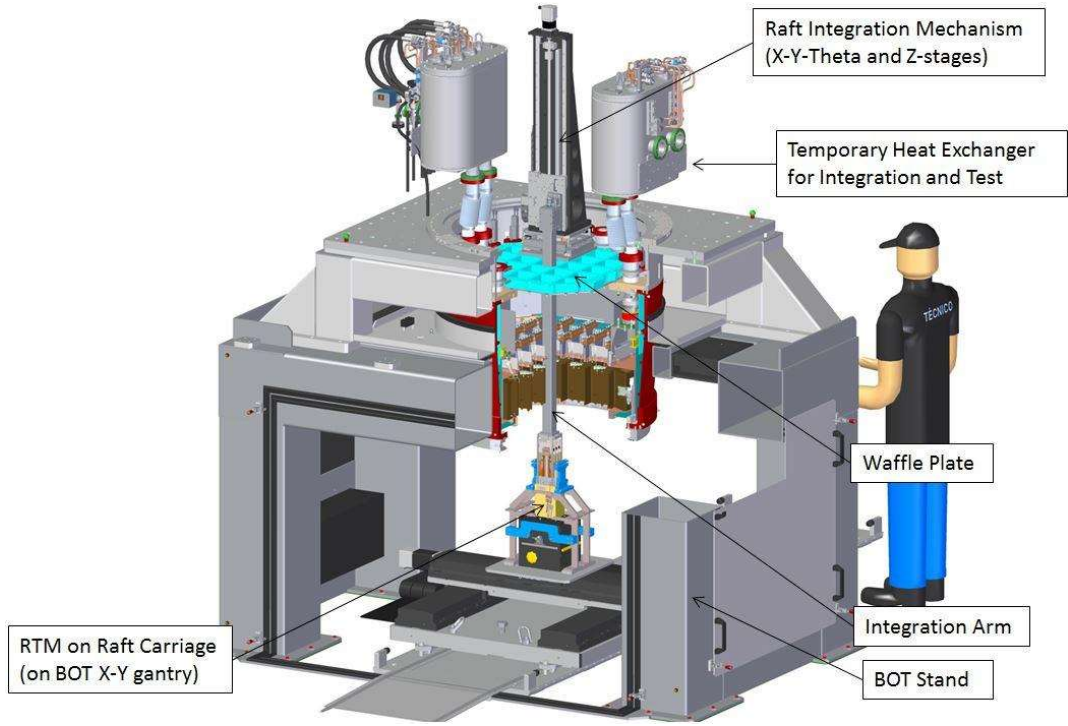

Figure 8: Overview of raft integration system supported on BOT stand.

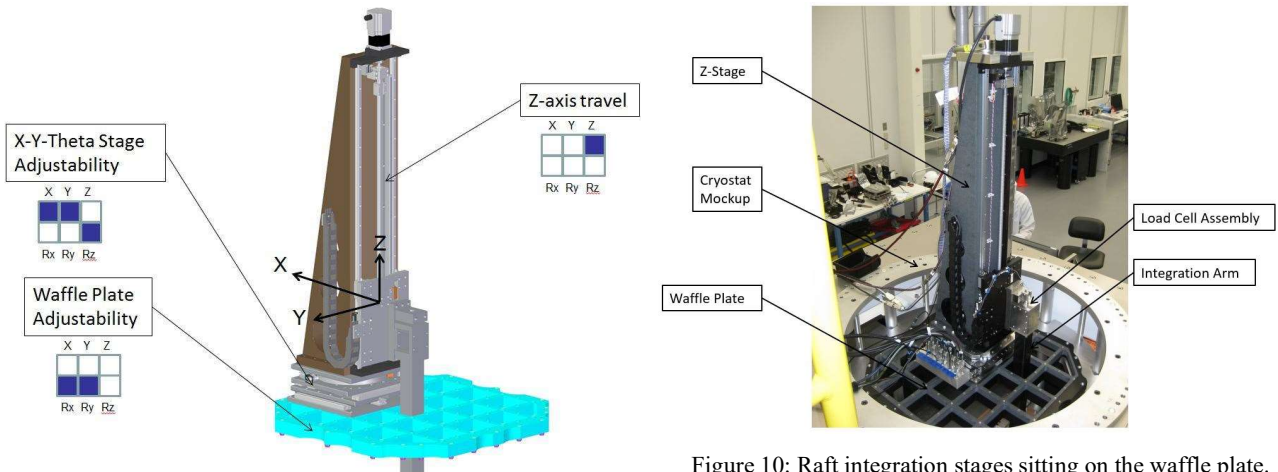

Figure 9: Various components control all 6 degrees of freedom of the system—a necessity for the stringent alignment needs.

Figure 10: Raft integration stages sitting on the waffle plate. The Waffle plate is mounted to a mockup of the cryostat which is supported by the BOT stand during early testing of the system.

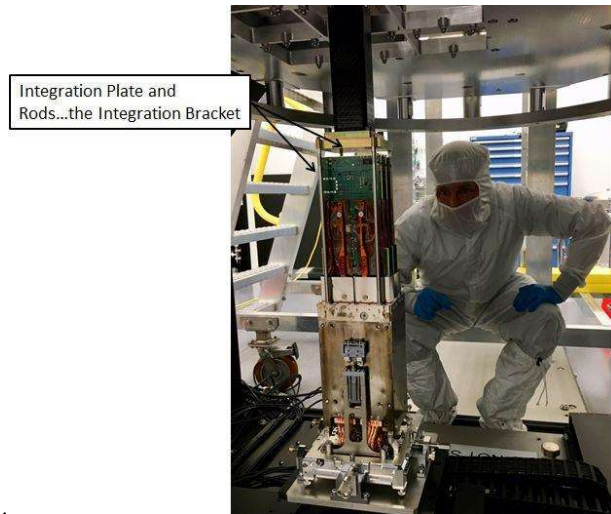

Figure 11: Access area to attach the RTM to the integration arm.

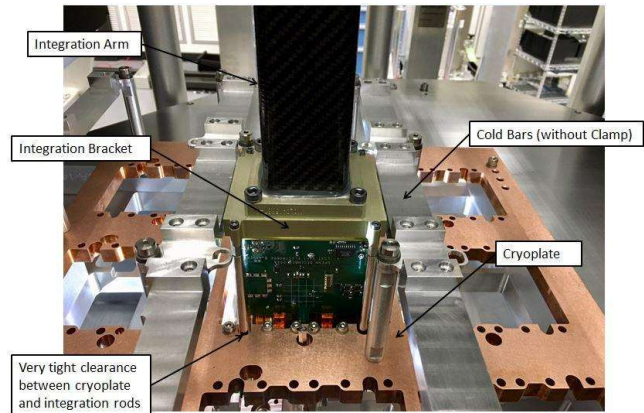

Figure 12: Raising the RTM past the cryoplate and cold bars of the cryostat mockup.

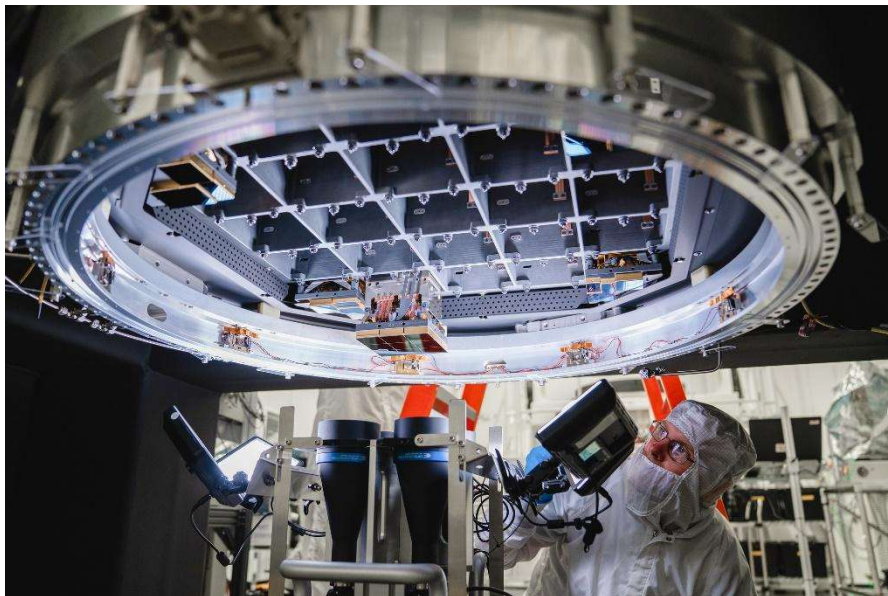

Figure 13: Cameras and lights installed to monitor the 4 corners of the raft assembly during installation. Credit: Jacqueline Orrell

### 3.4 Raft Integration Completion

The RTMs were integrated into the cryostat in two sequences. The first batch to be installed included the 4 corner raft tower modules (CRTM) plus 9 science raft tower modules. Figure 14 shows these 9 RTMs and 4 CRTMs after integration. Also shown in the image is a ring attached to the cryostat which contains 8  $^{55}\text{Fe}$  sources behind electromagnetic x-ray shutters. These were used to provide a semi-uniform number of ADU counts on the sensors in order to study gain stability as well as charge diffusion in the CCDs.<sup>2, 3</sup>

All connections were made between the RTMs and the internal cabling, the pump plate (which seals the back side of the cryostat and contains the vacuum components) was installed, and a flat, uncoated test window assembly was mounted to the front of the cryostat. The test window both sealed the vacuum as well as allowed for laser metrology of the sensor surface flatness<sup>4</sup>, a key requirement for the image quality error budget.

In addition to measuring the flatness of the sensor array, this testing period was the first opportunity to test the control of the thermal zones inside the cryostat and read out the CCDs. While this testing was limited in duration, it allowed for updates to software for controlling the temperatures and reading out the CCDs.



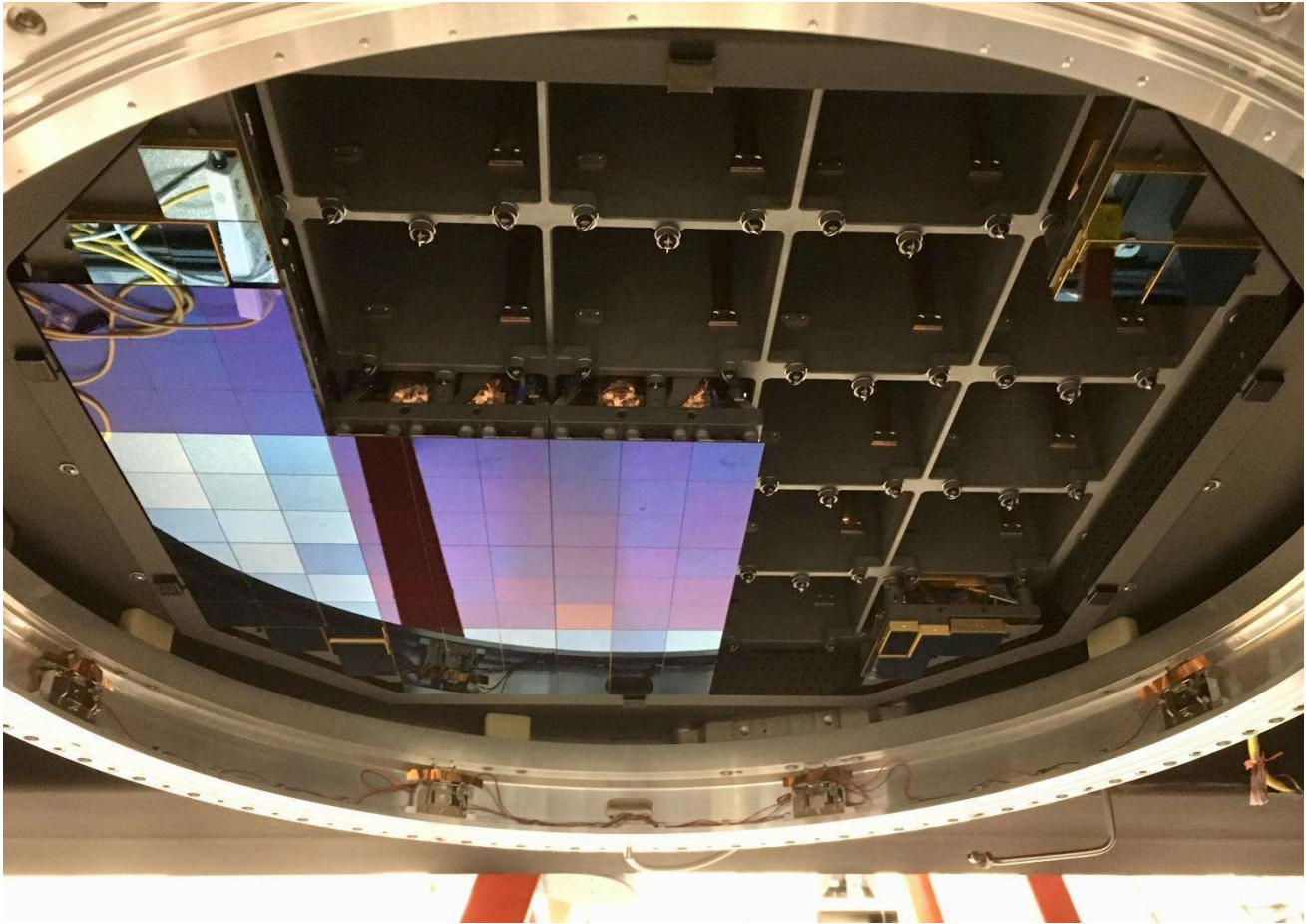

Figure 14: Focal plane after 9 science RTMs & 4 corner RTMs installed. Also shown in this image is the additional ring containing  $^{55}\text{Fe}$  sources behind x-ray shutters.

After the limited testing with 9 RTMs, the remaining 12 RTMs were installed sequentially. Since this operation had such high risk and associated cost of potential damage, we employed a large number of staff for each RTM installation (Figure 15). The operation included an overall lead, procedure lead, dedicated stage motion control (Figure 17), dedicated visualization lead (Figure 16), technician on top of the BOT, another technician to handle the RTM underneath the BOT stand, and two people dedicated to monitoring everyone else to ensure maximum sensor safety. While this was a large overhead, it allowed everyone to focus on one task only and resulted in no damage to any of the sensors.

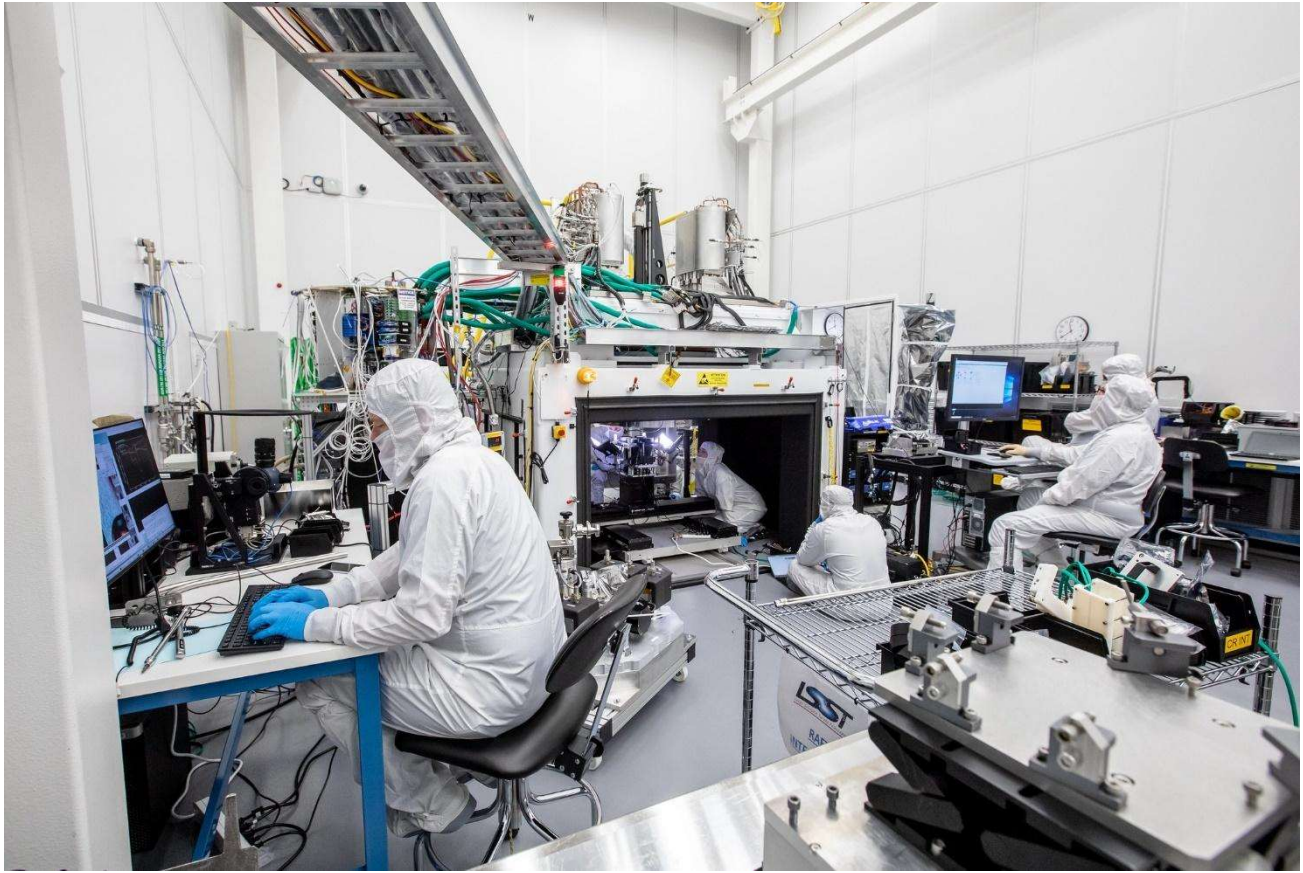

Figure 15: Large number of staff working around the BOT stand while installing RTMs into the cryostat. Credit: Jacqueline Orrell



Figure 16: Dedicated operator for sensor edge visualization. Credit: Jacqueline Orrell



Figure 17: Dedicated operator for custom stage motion control. Credit: Jacqueline Orrell



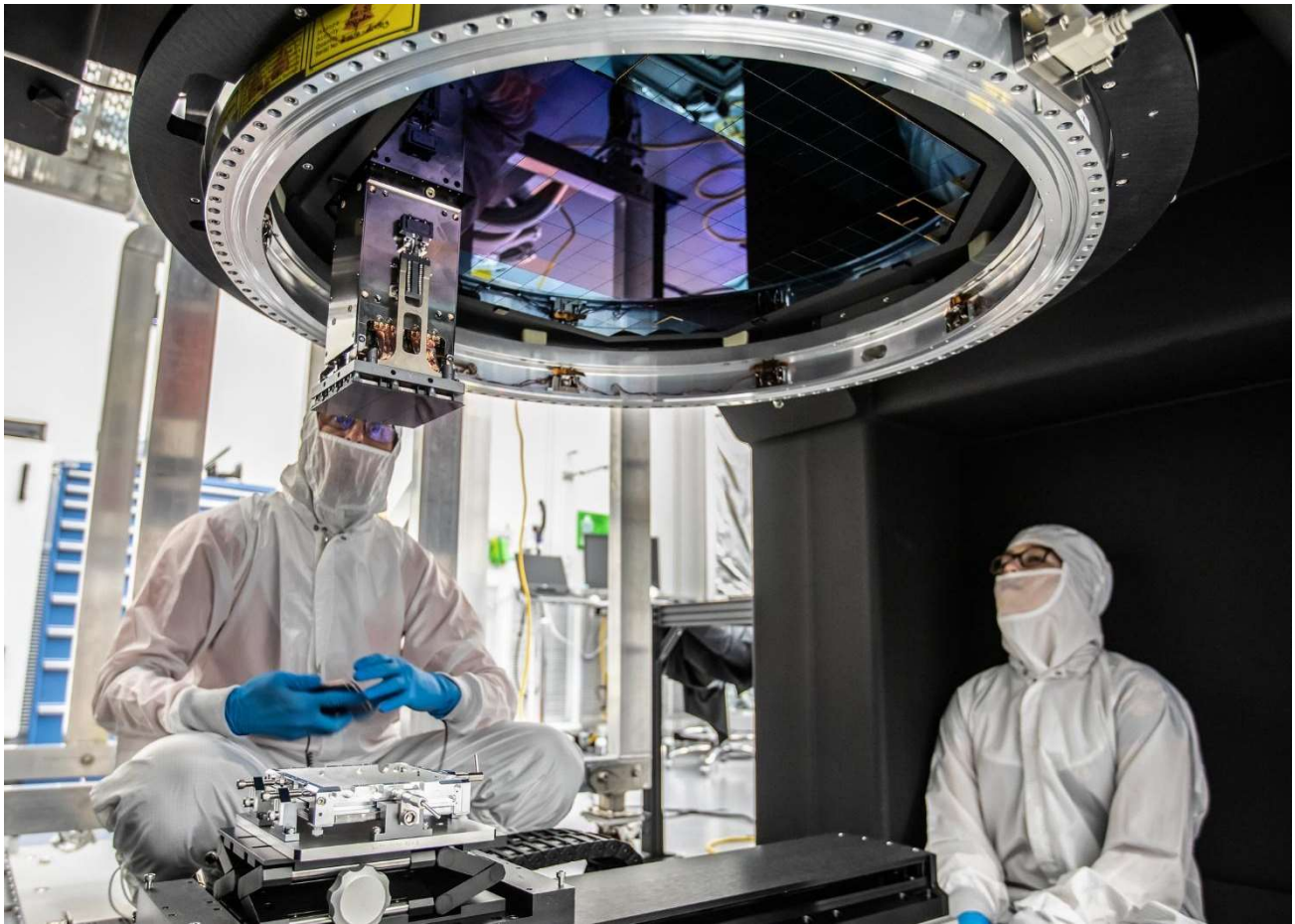

Figure 18: Installing the final RTM into the cryostat. Credit: Jacqueline Orrell

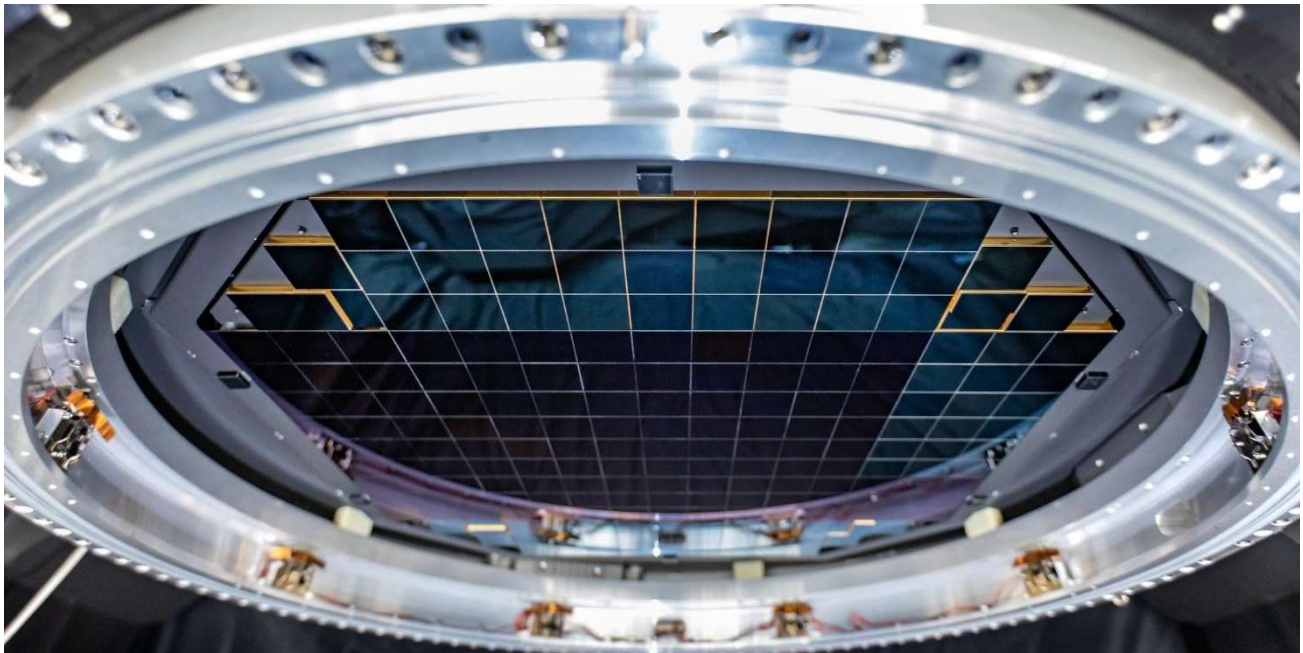

Figure 19: Fully assembled focal plane. Credit: Jacqueline Orrell



### 3.5 Cryostat Closeout

Not stated in the previous section, after each RTM was installed, both power and data cables were connected to each of the three raft electronics boards (REBs) on the RTM. Including the REBs from both the RTMs and CRTMs, more than 2000 wires for power penetrate the cryostat vessel. In addition to the power cables, each REB has a ribbon cable with 12 conductors. The ribbon cables from 12 REBs come together at a transition module which converts the data signal from copper wire to optical fiber with multiplexing. Both the REB power (Figure 21) and optical transition module (OTM, Figure 20) are potted into standard conflat (CF) flanges: 2.75" CF for the OTM and 4.5" CF for the REB power feedthrough. Given that each of these feedthrough assemblies have wires penetrating the vacuum barrier, care must be used when handling and terminating each end.

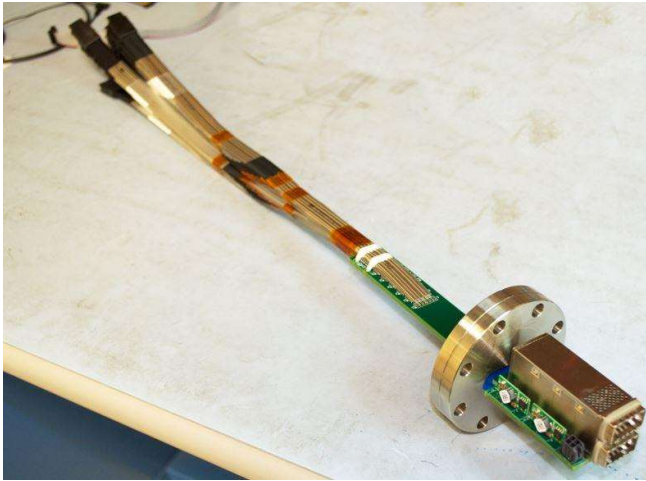

Figure 20: Optical transition module (OTM)

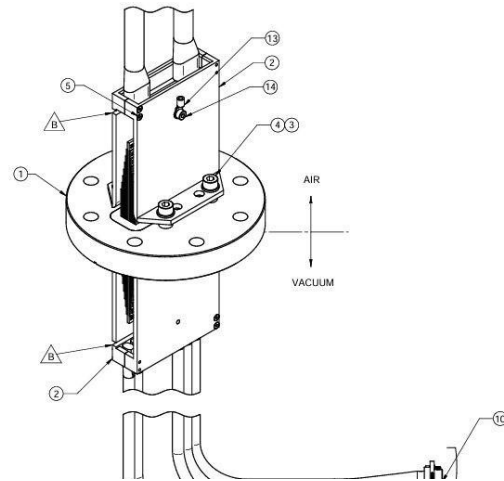

Figure 21: REB power feedthrough

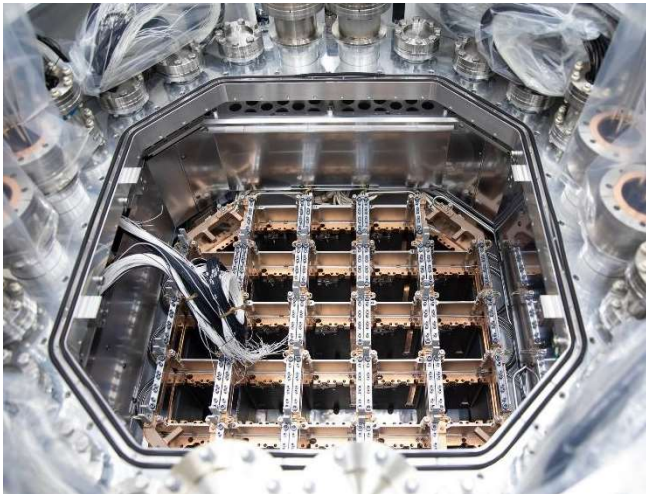

Figure 22: Empty bays of cryostat grid

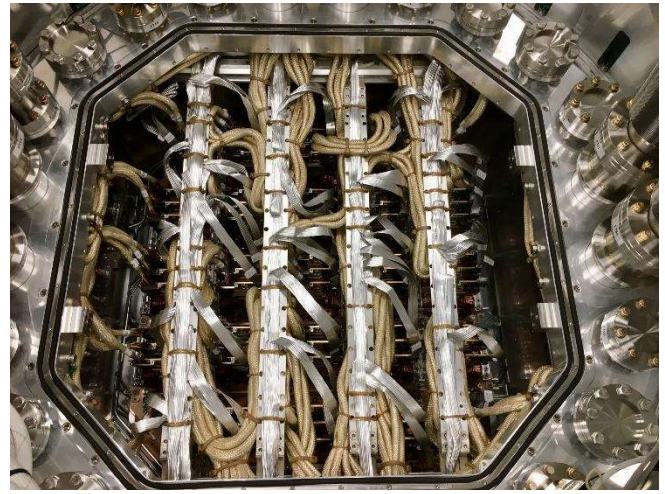

Figure 23: Fully populated cryostat, with OTM ribbon cables and REB power feedthrough cables

### 3.6 Cryostat Integration with Utility Trunk

Nearly all of the support electronics for the Camera reside in a structure we call the utility trunk. That structure was physically attached to the cryostat as shown in Figure 24, and all of the utility connections were made between them (REB power, vacuum, air, rigid refrigeration lines inside vacuum bellows, and many data cables).



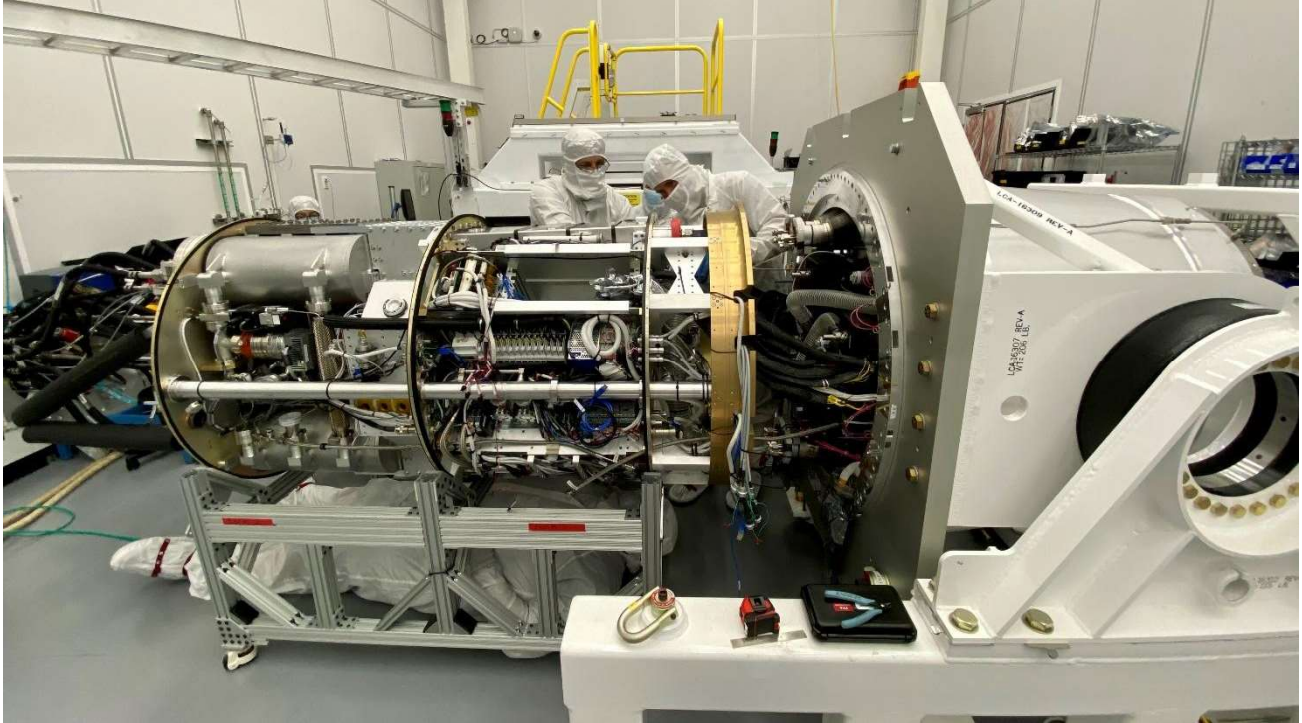

Figure 24: Utility Trunk Integration with Cryostat.

## 4. CAMERA ASSEMBLY

### 4.1 Camera Body Assembly

As shown in Figure 3 and Figure 4, the assembly of the cryostat and the main camera body take place in parallel. The camera body subsystem provides the main structure of the entire Camera; the back flange portion of the camera body both acts as the attachment point for the cryostat, and is also the interface to the telescope mount assembly (TMA). The assembly of the camera body was completed by that subsystem, so it is not discussed in detail here. The caveat to that is that part of the filter exchange system was integrated with the camera body subsystem due to lack of access once the full camera body was assembled.

The back flange was sent to our collaborating institution in Paris so they could integrate the carousel assembly (part of the filter exchange system) prior to the integration of the camera housing to the back flange. Figure 25 shows the integration of the main camera housing with the back flange.

### 4.2 Cryostat Integration with Camera

The assembled cryostat and utility trunk assembly is both supported and mounted on a midplane flange. The center of gravity is not perfectly coincident with that flange, however. A special lift fixture was mounted to the cryostat support flange; it has pick points at several locations to accommodate various center of gravity locations. A picture of the full assembly suspended from the crane can be seen in Figure 26.

The cryostat assembly was inserted into the camera body as shown in Figure 27. Because there is no access once the cryostat is installed in the camera body, the cover for the vacuum barrier lens (L3) was removed prior to insertion.



Figure 25: Camera housing (in black) integration with back flange (in gold). Part of the filter exchange system carousel is visible on the back flange.

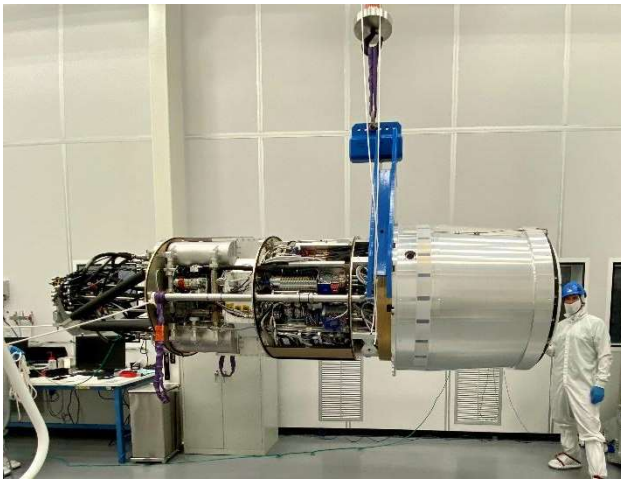

Figure 26: Cryostat & utility trunk assembly suspended by cryostat "C-Hook" lift fixture



Figure 27: Cryostat being inserted into the camera body. Cover is removed from L3.

### 4.3 Integration of the L1-L2 Assembly

The primary corrector optics for the LSST Camera were mounted together on a carbon fiber structure and aligned to one another at the vendor prior to arriving at SLAC. For mechanical support, the structure is mounted to 3 bipod strut pairs which form a hexapod. We refer to this entire unit as the L1-L2 assembly.

This assembly was assembled to the camera body with the optical axis horizontal, though the assembly was received with the axis vertical as shown in Figure 28. To reorient the assembly, the cover for L1 was installed, and a lifting ring was lowered around the L1-L2 assembly and coupled to it with a linkage system (Figure 30) to prevent over-constraint. The assembly was lifted with a crane as shown in Figure 29 and mounted to a support stand on which it could be rotated as shown in Figure 31.



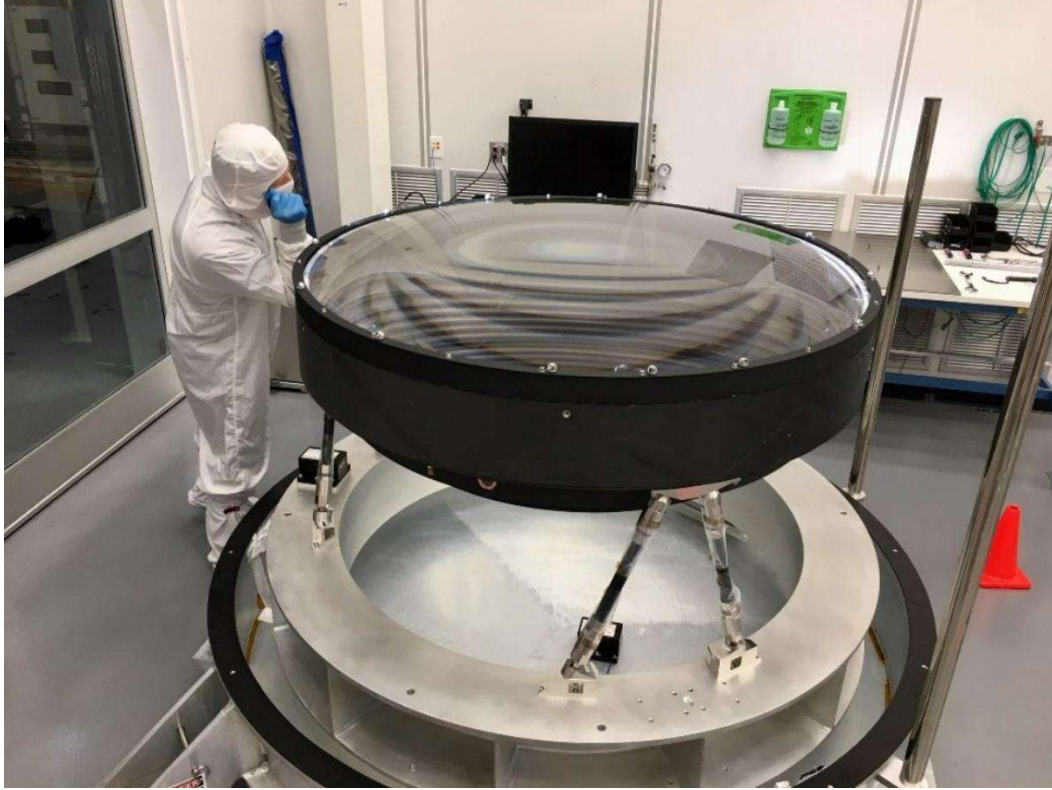

Figure 28: L1-L2 assembly as received at SLAC

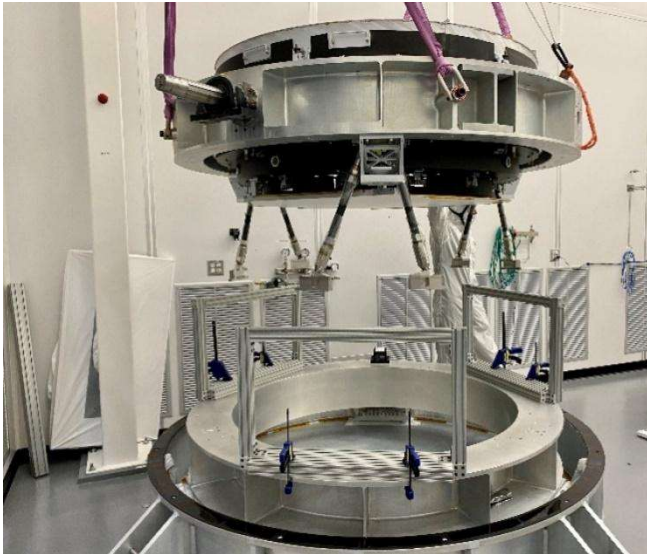

Figure 29: Lifting ring, connected to L1-L2 structure, lifted off shipping frame

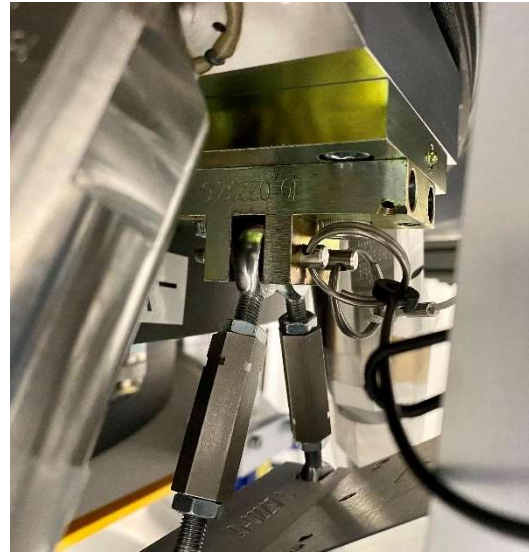

Figure 30: Linkage between L1-L2 structure and lifting ring



Figure 31: L1-L2 mounted to support stand which allows change in orientation

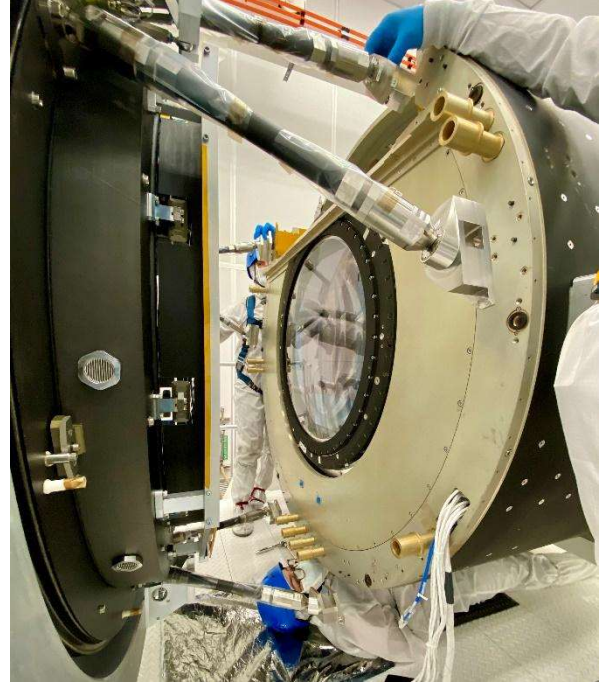

Figure 32: Mounting the 6 independent struts to the camera body

With six struts all free to move independently, mating the L1-L2 assembly to the camera body required many hands. Specifically, it required three people, each managing a pair of struts as shown in Figure 32. Because the struts have independent degrees of freedom, they were mated to the camera body one at a time, starting with the feet shown in the top of Figure 32.

Once the fasteners for all 6 mounting feet were fully torqued, the linkage between the L1-L2 structure and the lifting ring was disconnected, and the ring moved away from the Camera as shown in Figure 33.



Figure 33: Removing the L1-L2 Lifting Ring from the Camera



The location of the best-fit optical axis was based on subsystem measurements made at the vendor in combination with the as-built data for the focal plane with respect to the camera body. The Camera has rings of nests for ball mount retroreflectors at several locations: the back flange, the front of the camera body housing, on the frame of the L3 lens assembly, the cells of both the L1 and L2 lenses, as well as at the front of the Camera adjacent to the L1 lens.

The Camera was reoriented to point toward the floor as shown in Figure 34, and a laser tracker was used to measure the nest locations to an accuracy of 25  $\mu\text{m}$ . Based on the measurements and the optical model, the L1-L2 struts were adjusted to move the assembly into position in all six degrees of freedom. The design of the struts has a 32 thread per inch (TPI) screw on one end and 30 TPI on the other. By adjusting one end, a coarse adjustment in length can be made. A differential fine adjustment can be made by holding the two ends fixed and rotating the center as shown in Figure 35.

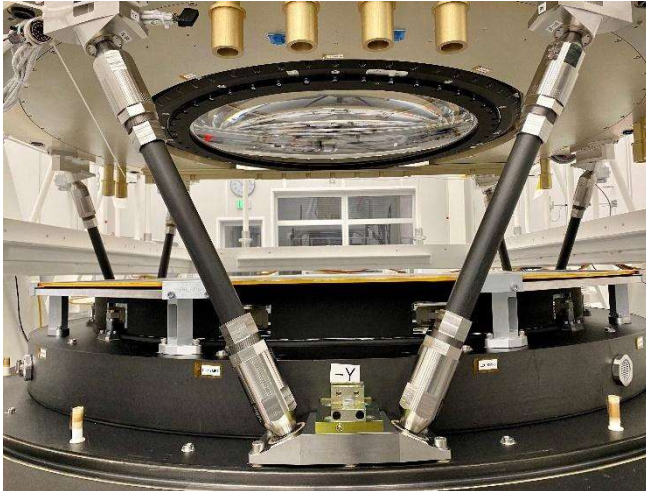

Figure 34: Camera axis vertical in preparation to adjust L1-L2 struts



Figure 35: Adjusting the differential screw of the L1-L2 strut

#### 4.4 Installing the Shutter Assembly

The shutter assembly mounts to the front flange of the camera body housing, and its closest blade is only 3 mm from the apex of the L3 optic. In addition to the close proximity to L3, the struts for L1-L2 are obstacles which the shutter must avoid during installation.

Because of these constraints, the motion profile of the shutter during installation has 10 different moves utilizing 5 degrees of motion. In order to achieve that motion profile, we designed a mechanism which we call the shutter extraction rail. It has 3 linear motion stages and 2 rotation stages, all of which are motorized and controlled through a single terminal.

For installation of the shutter assembly, the Camera needs to be rotated about the optical axis by 60 degrees, after which the shutter extraction rail is bolted to the outside diameter of the camera body as shown in Figure 36. The shutter assembly, which weighs ~100 lb, is lifted on a carrier frame and transferred to the shutter extraction rail as shown in Figure 37. The extraction rail then sequences the shutter through the complex series of moves in order to avoid the L1-L2 struts and ultimately mount the shutter assembly to the camera body front flange.



Figure 36: Shutter extraction rail lifted into place and bolted to outside diameter of camera body

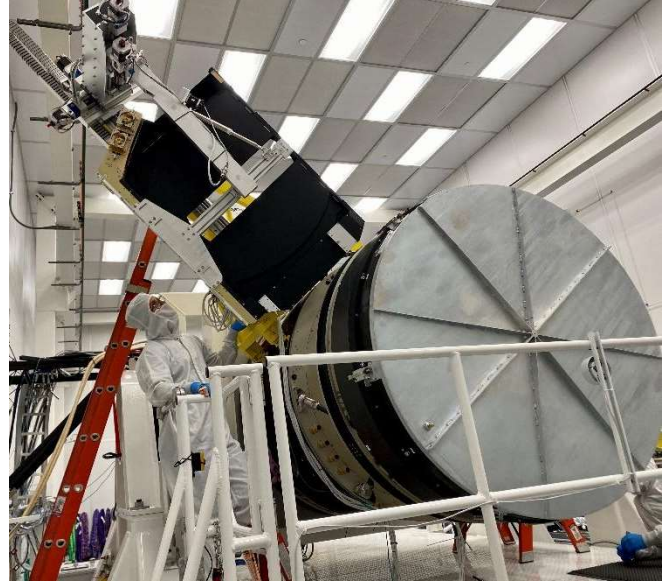

Figure 37: Shutter installed onto extraction rail

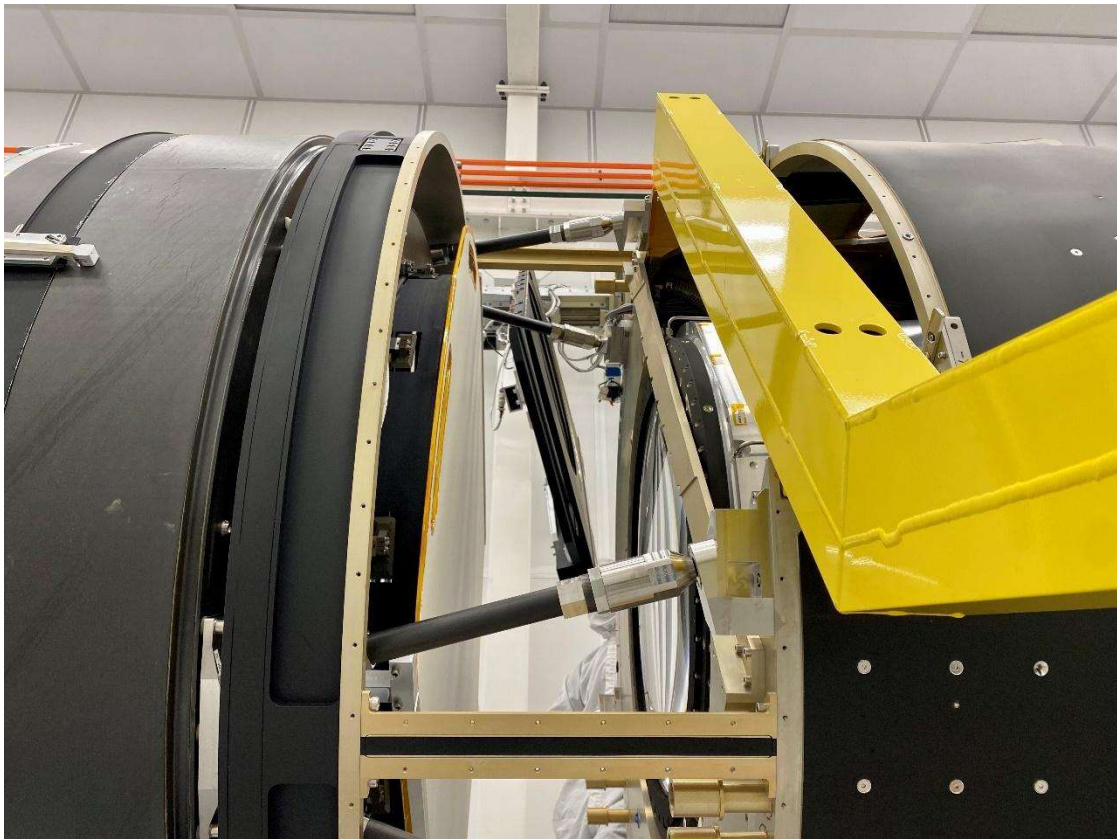

Figure 38: Shutter assembly in process of installation on the extraction rail. Yellow beam is a weight to counteract the weight of the extraction rail.



#### 4.5 Installing the Filter Exchange System

The filter exchange system consists of three major components: the carousel, the auto changer and a filter loader. The carousel is the mechanism which holds five filter assemblies and rotates them about the Camera axis inside the camera body. The auto changer moves a single optical filter from the carousel to its position in front of the focal plane. The filter loader installs or removes a filter from the Camera. The installation of the carousel was covered in section 4.1. The filter loader is offline support hardware that is not part of the Camera assembly.

The auto changer was the final piece of the camera to be installed. Since the auto changer is nestled in close proximity to both the shutter and the L2 optic, a pair of guide rods must be first bolted to the outside of the camera body as shown in Figure 39. The guide rods were removed after the auto changer was installed.

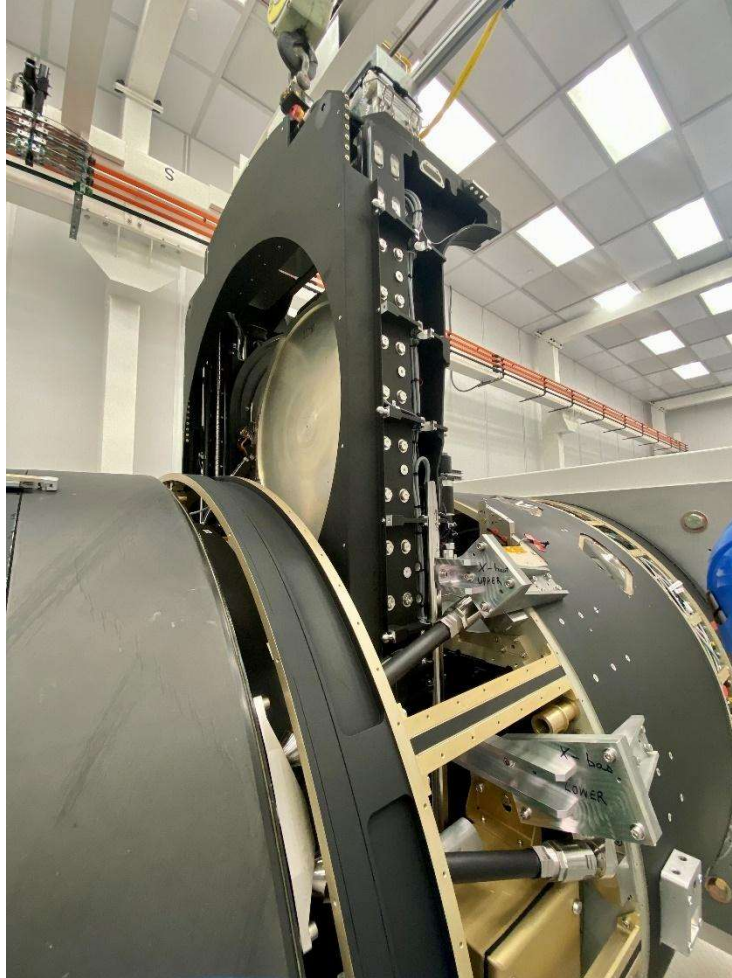

Figure 39: Auto changer installation into the Camera. Guide rods provide precision motion.

#### 4.6 Revealing the Final Camera Assembly

With the auto changer installed and cables connected, the shroud panels which close off the space between the camera housing and the L1-L2 assembly were installed. The L1 cover was removed to reveal the complete LSST Camera as shown in Figure 40. A portion of the team responsible for integrating and testing the LSST Camera is shown in Figure 41 celebrating the completion of the LSST Camera integration and test.

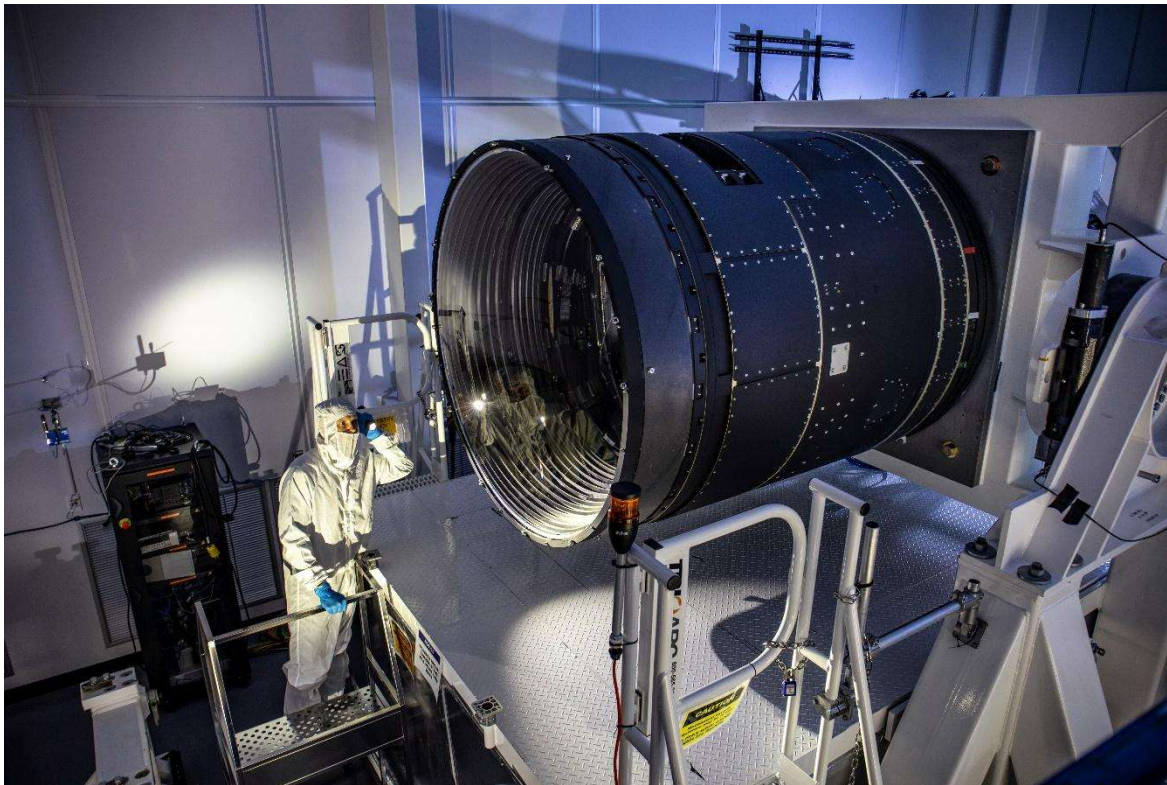

Figure 40: Inspecting the L1 lens after the LSST Camera completion

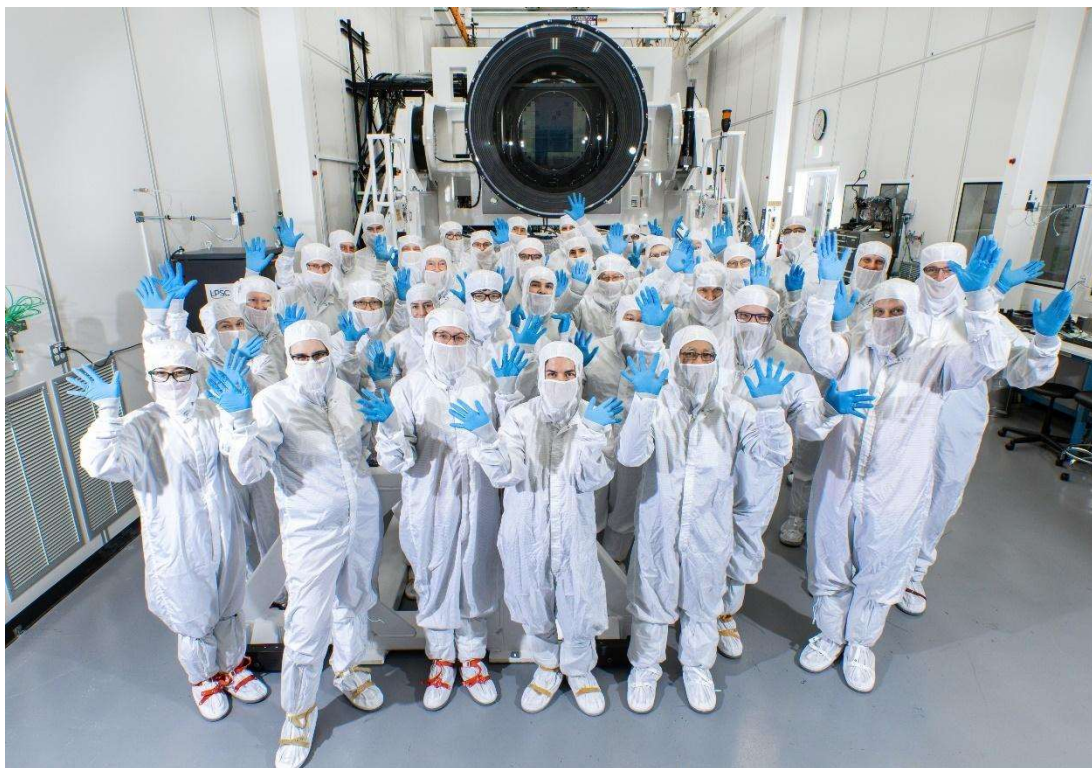

Figure 41: A Portion of the LSST Camera team celebrates completion of I&T



## 5. CHALLENGES DURING CONSTRUCTION

As with many bespoke scientific projects, unplanned challenges arose during the decade of construction. The key to overcoming those challenges was a combination of creativity and a diverse pool of technical expertise. In this section, we highlight just a couple of challenges which had significant impact on the LSST Camera construction.

### 5.1 Metallic Contamination of CCD Wire Bonds

In section 2, we discussed the plan for the LSST Camera I&T campaign. The graphic shown in Figure 5 shows the planned steps for the raft tower modules once received from our partner institution—the first step was verifying their performance to ensure there were no issues caused by shipping. Very early in that process, we noticed several shorts on some CCD channels. After investigating, some small metallic pieces were found bridging across CCD wire bonds as seen in Figure 42. For comparison a clean CCD is shown in Figure 43.

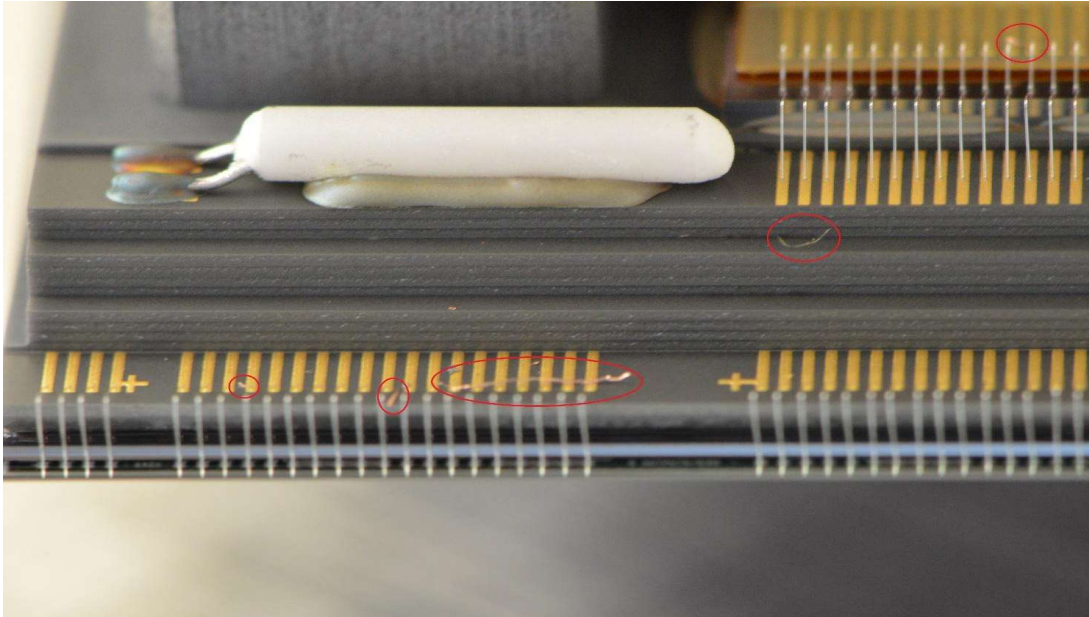

Figure 42: Metallic pieces bridging across wire bonds on CCDs

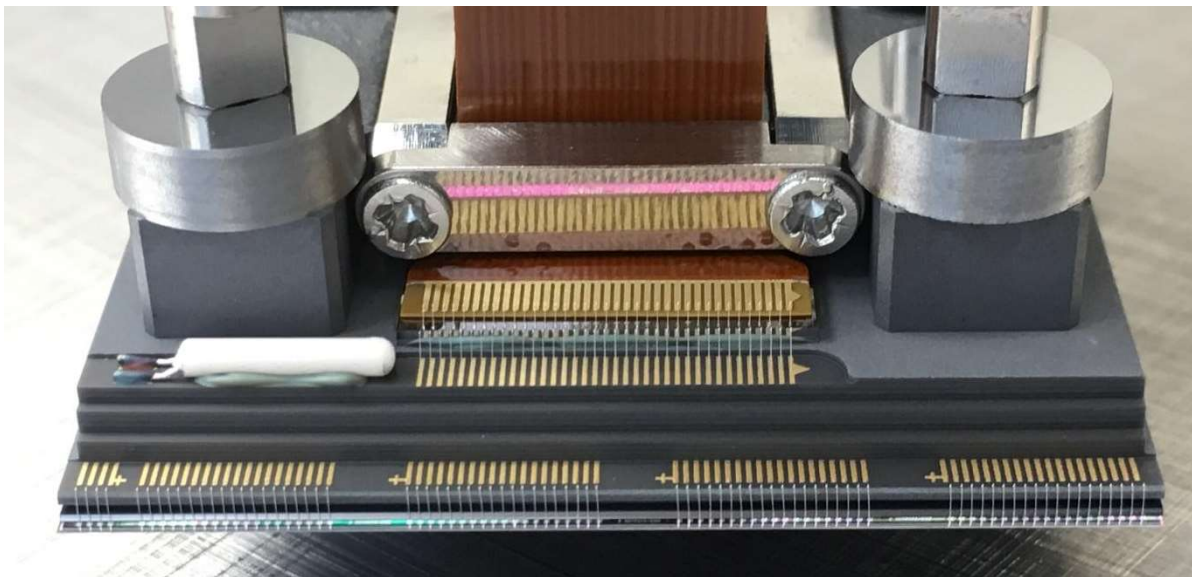

Figure 43: Example CCD with no metallic particles on wire bonds

The solution we devised had two parallel paths: disassemble and clean all of the components to remove any loose particles and mitigate the sources of those particles. Cleaning the sensor wire bonds was a meticulous and time-consuming process involving a fiber borescope and a very small HEPA vacuum. An example of the cleaning can be seen in Figure 44. Several steps were needed to mitigate the sources of the particles. First, there are several braided copper thermal straps (as shown in Figure 45). Each of these was wrapped in a kapton sleeve to eliminate any shedding. Second, the threaded holes in the copper walls of the RTMs were modified from machined threads and replaced with a Nitronic 60 threaded insert. Lastly, the openings in the ceramic base plate through which the CCD ribbon cable is routed were plugged with a PEEK insert to reduce the open cross-sectional path to the wire bonds. These changes can be seen in Figure 44.



Figure 44: Verifying cleanliness on raft sensor assembly (RSA)

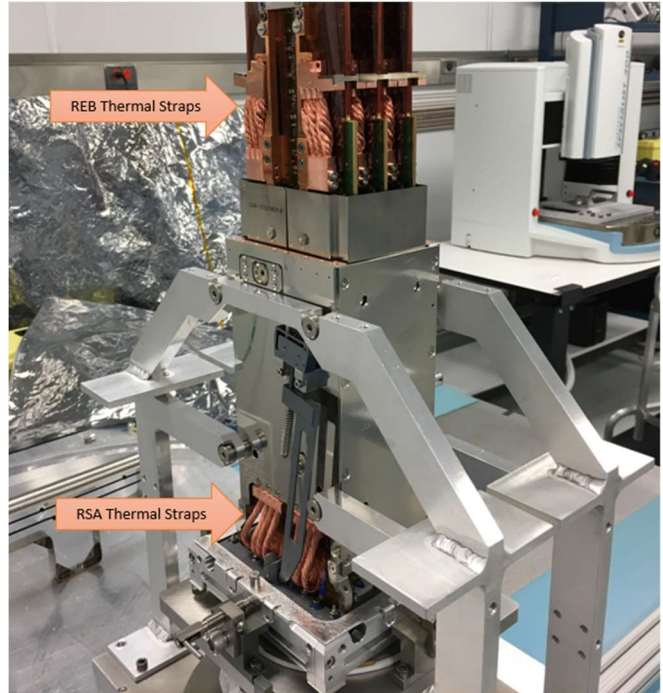

Figure 45: Thermal strap locations on RTM

## 5.2 Vacuum System Failures

Because the CCDs are optimized for operating at  $-100^{\circ}\text{C}$ , they must be operated in an environment absent of air molecules which would otherwise condense on the cold surfaces (water and carbon dioxide in particular). In order to prevent this outcome, the RTMs are kept in a vacuum cryostat. As mentioned in section 3.4, there are wire penetrations from the air into the vacuum. In the summer of 2023 while the onboard turbo pump was being operated to evacuate the cryostat, the internal pressure remained elevated. Our investigation discovered a leak in the epoxy of one of the REB power feedthrough assemblies. Access to this location was very difficult, and replacing the feedthrough would have required a major disassembly of the entire camera.

Our solution was to perform offline testing on a variety of epoxies for compatibility with the 3M Scotchweld 2216 B/A gray epoxy which constitutes the potting for the REB power feedthrough. Because there was a concern about creating a virtual leak by applying epoxy on the external surface, we ultimately decided to use the lowest viscosity 2-part epoxy available—Master Bond EP30-LP. We maintained pumping on the cryostat while applying a thin coat with a syringe as shown in Figure 46.



Figure 46: Applying Master Bond EP30-LP epoxy to REB power feedthrough with vacuum leak

The second issue with our vacuum occurred at the beginning of 2024 when starting up our cryostat turbo pump after a period of inactivity. There was an unusual squealing sound, followed by the pump stopping—a telltale sign of a bearing failure in the pump. Further investigation proved that the pump had in fact failed.

The turbo pump is mounted to the pump plate assembly, which seals the back of the cryostat vacuum vessel. Once the cryostat was integrated with the utility trunk, access to the pump plate was very difficult. Access to the cryostat turbo pump when the camera is mounted to the integration stand is not possible, so the camera was moved to the smaller saddle stand which provides better access around the camera.

With planning and some custom tooling, the turbo pump was ultimately replaced through the opening shown in Figure 47 and Figure 48. A picture of the new turbo pump installed on the pump plate is shown in Figure 49.

The failed pump had 18,500 hours of operation and had not been exposed to high gas loads. A failure analysis report indicated bearing failure, but it did not provide any more insight into the cause of failure. A key outcome is that we now have a procedure and tooling to replace the turbo pump, knowing that this is a potential failure in the future.





Figure 47: Utility trunk with outer skins removed

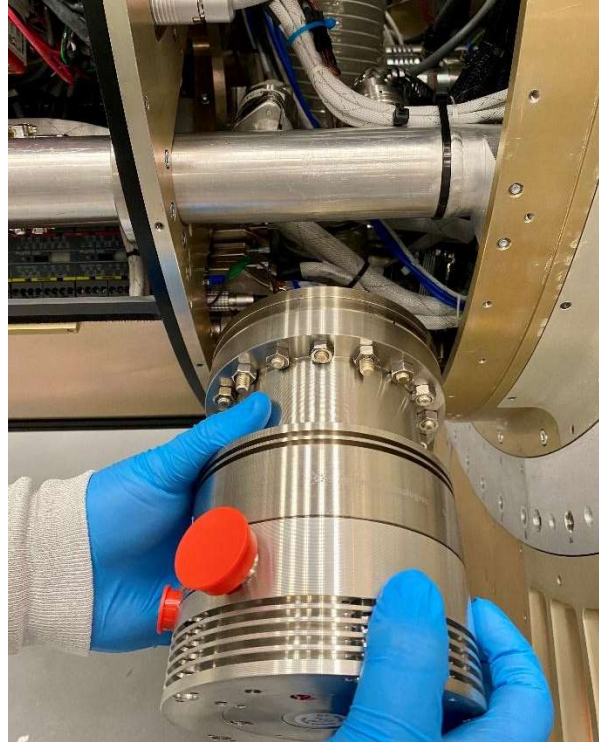

Figure 48: Testing access to remove the turbo pump

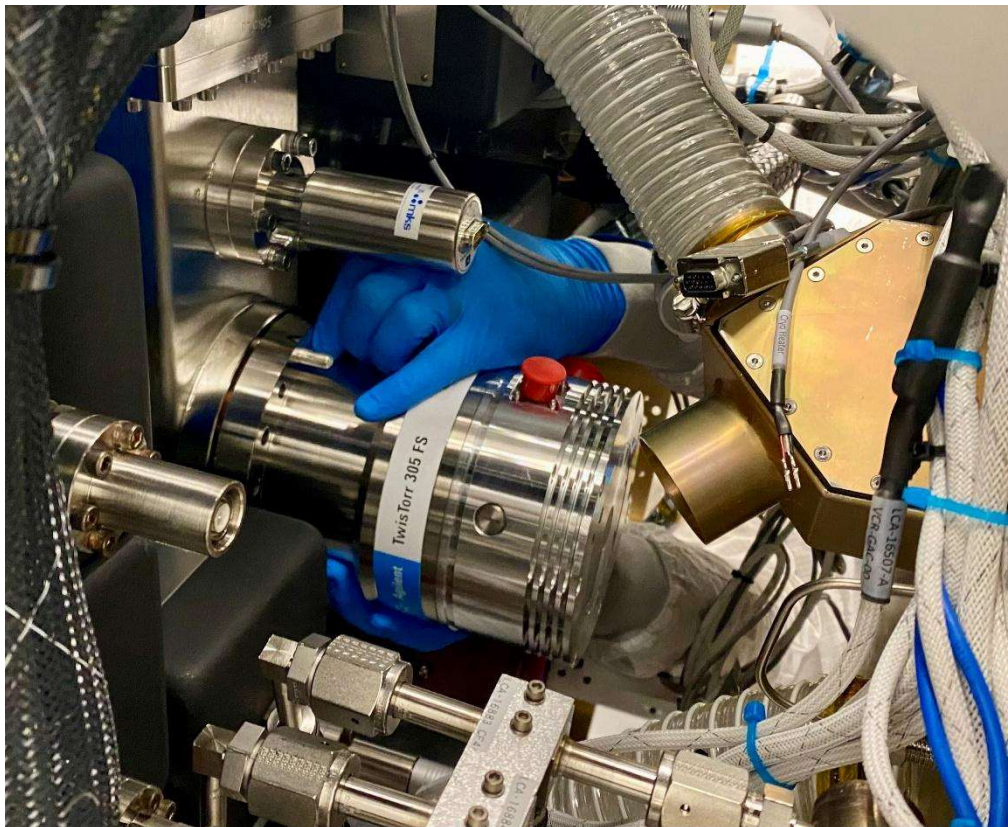

Figure 49: New turbo pump installed. Several cables and hoses needed to be disconnected to provide enough access



## 6. CONCLUSIONS

While the LSST Camera has not yet been fully commissioned in Chile, the construction is complete, and it has been successfully shipped from SLAC National Accelerator Lab to the Vera Rubin Observatory on Cerro Pachon<sup>5</sup>. The work to successfully resolve a myriad of challenges during the decade of construction is a testament to the creativity and technical expertise of the team at SLAC and partner institutions.

## 7. ACKNOWLEDGMENTS

This material is based upon work supported in part by the National Science Foundation through Cooperative Agreement 1258333 managed by the Association of Universities for Research in Astronomy (AURA), and the Department of Energy under Contract No. DE-AC02-76SF00515 with the SLAC National Accelerator Laboratory. Additional LSST funding comes from private donations, grants to universities, and in-kind support from LSSTC Institutional Members.

## 8. REFERENCES

- [1] Ivezić, Z. et al., “LSST: From Science Drivers to Reference Design and Anticipated Data Products”, *ApJ* 873, 111 (Mar. 2019). DOI: <https://doi.org/10.3847/1538-4357/ab042c>.
- [2] Roodman, A. et al, “LSST Camera Verification Testing & Characterization”, *Proc. SPIE 13096-90, Ground-based and Airborne Instrumentation for Astronomy X*, in press (2024).
- [3] Utsumi, Y. et al, “LSST Camera Focal Plane Optimization”, *Proc. SPIE 13103-47, X-ray, Optical and Infrared Detectors for Astronomy XI*, in press (2024)
- [4] Rasmussen, A. et al, “Focal Plane Figure Knowledge and Control for Rubin Observatory’s LSST Camera”, in [*Journal of Astronomical Telescopes, Instruments and Systems*], *Image Sensors for Precision Astronomy*, in press (2025).
- [5] Lopez, M. et al, “Logistics and Outcomes of the Rubin Observatory LSST Camera Shipment”, *Proc. SPIE 13098-63, Observatory Operations: Strategies, Processes and Systems X*, in press (2024).
- [6] Bond, T. et al, "LSST Camera - Integration and Test Subsystem: Planning and Status", *Proc. SPIE 10705, Modeling, Systems Engineering, and Project Management for Astronomy VIII*, 107050E (10 July 2018); <https://doi.org/10.1117/12.2314244>.