



**HAL**  
open science

## Supercritical CO<sub>2</sub>-assisted flow chemistry for processing switchable molecular nanomaterials

Anaïs Marchetti, Nathalie Daro, Samuel Marre, Guillaume Chastanet, Cyril Aymonier

► **To cite this version:**

Anaïs Marchetti, Nathalie Daro, Samuel Marre, Guillaume Chastanet, Cyril Aymonier. Supercritical CO<sub>2</sub>-assisted flow chemistry for processing switchable molecular nanomaterials. École Résidentielle Interdisciplinaire en Nanosciences et Nanotechnologies – Retour sur évènement, Jul 2021, Erquy, France. hal-04762150

**HAL Id: hal-04762150**

**<https://hal.science/hal-04762150v1>**

Submitted on 31 Oct 2024

**HAL** is a multi-disciplinary open access archive for the deposit and dissemination of scientific research documents, whether they are published or not. The documents may come from teaching and research institutions in France or abroad, or from public or private research centers.

L'archive ouverte pluridisciplinaire **HAL**, est destinée au dépôt et à la diffusion de documents scientifiques de niveau recherche, publiés ou non, émanant des établissements d'enseignement et de recherche français ou étrangers, des laboratoires publics ou privés.

# SUPERCritical CO<sub>2</sub>-ASSISTED FLOW CHEMISTRY FOR PROCESSING SWITCHABLE MOLECULAR NANOMATERIALS

Anais MARCHETTI, Nathalie DARO, Samuel MARRE, Guillaume CHASTANET, Cyril AYMONIER  
CNRS, Univ. Bordeaux, Bordeaux INP, ICMCB, UMR 5026, 33600 Pessac, France

## Context

Molecular switches are getting increasingly implemented in functional materials for sensing applications and in molecular electronics. Among this family, the Fe(II) spin crossover (SCO) materials are studied with great interest due to their ability to change their electronic configuration. The material chosen for this study is an archetypal 1D-polymeric compound based on Fe(II) and triazole ligand. Such materials are close to applications and there is a need to obtain larger quantities of this product and more reliable processes. We address this challenge using an innovative approach based on flow chemistry to synthesize SCO nanoparticles in a reliable one-step process.

**Objectives:** Convert the classical batch synthesis method to a continuous system, coupled with a supercritical CO<sub>2</sub> (scCO<sub>2</sub>)-assisted drying ; control the nanoparticles sizes ; synthesize heterostructures.

## Spin-Crossover materials

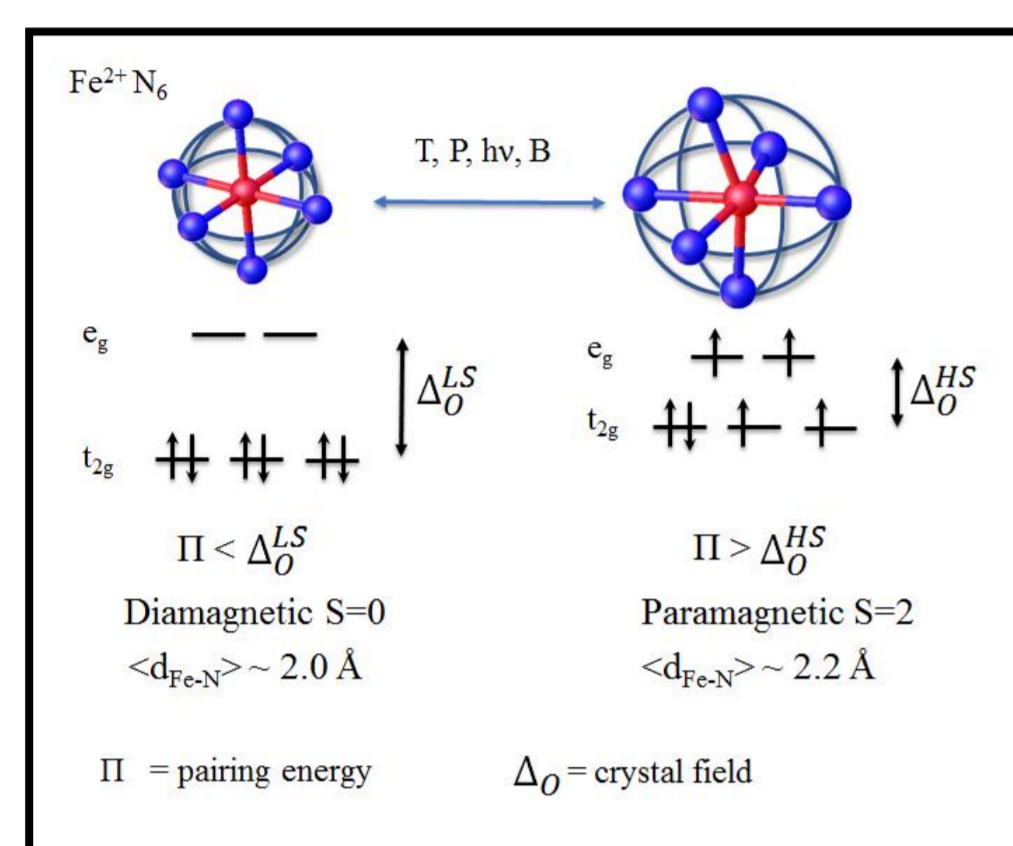

Upon an external stimulus (temperature, pressure or light-irradiation), a spin-crossover compound switches from a low-spin to a high-spin state. [1]

### The case of the [Fe(Htrz)<sub>2</sub>(trz)](BF<sub>4</sub>)

Stable, largely investigated and exhibits SCO properties at relatively mid temperatures. [2,3,4]

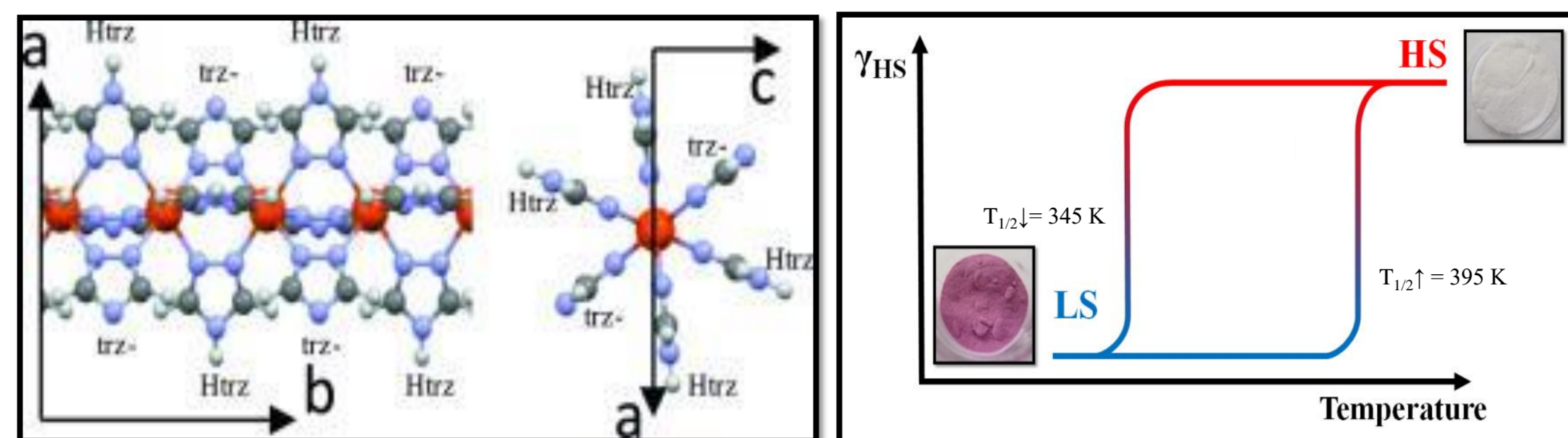

This structure leads to rod-shaped particles, even upon size reduction. [5]

### Potential applications

Thermochromic display [7]

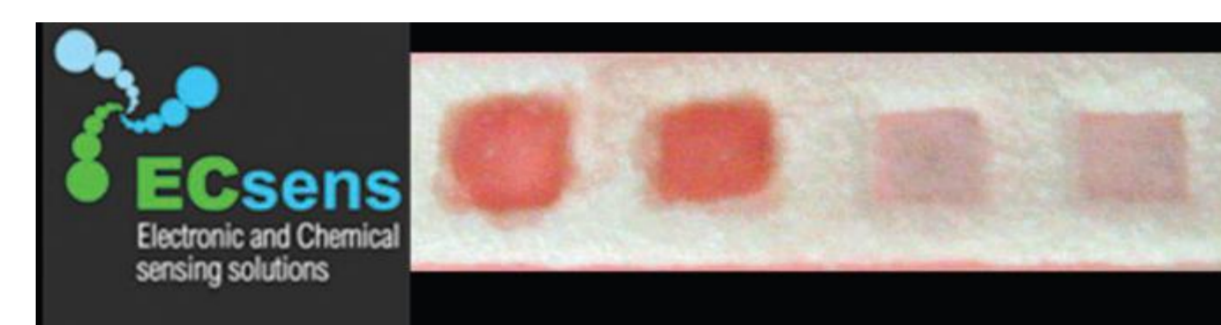
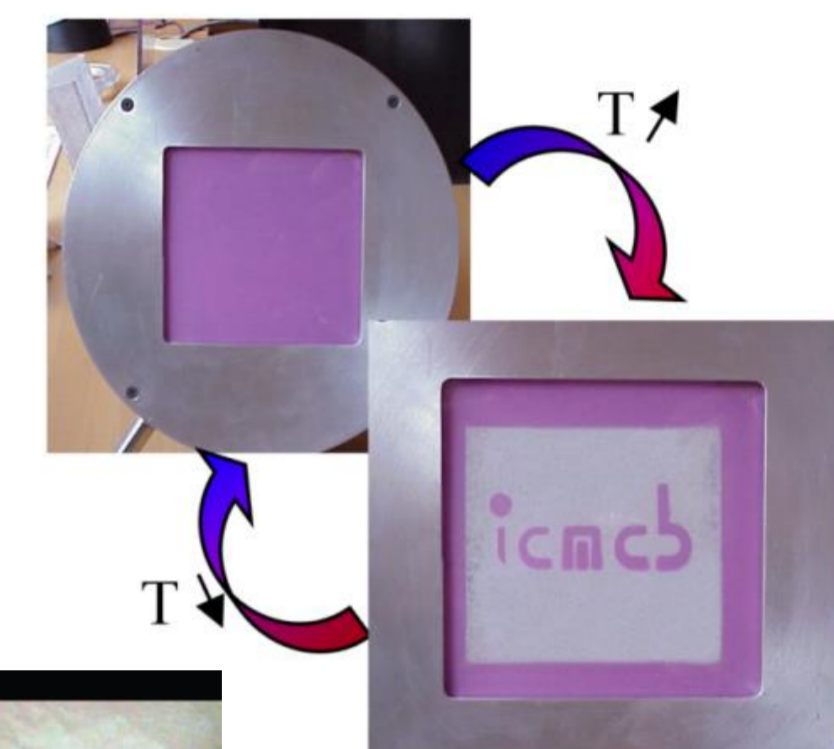

Temperature sensor [6]

## Synthesis

### Reaction

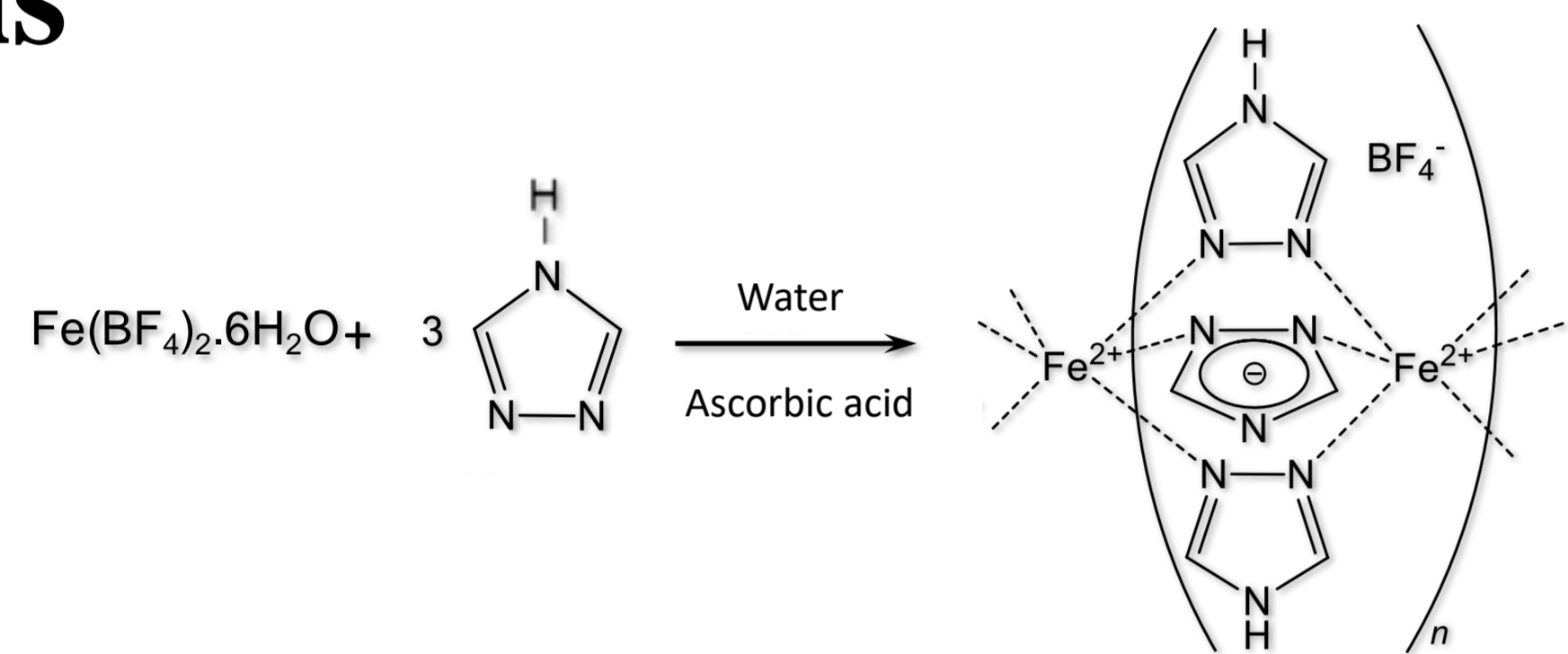

### Parameters studied

- Temperature.
- Reactants concentration.
- Synthesis duration.
- Additives addition, pH of the solution.

### Batch approach

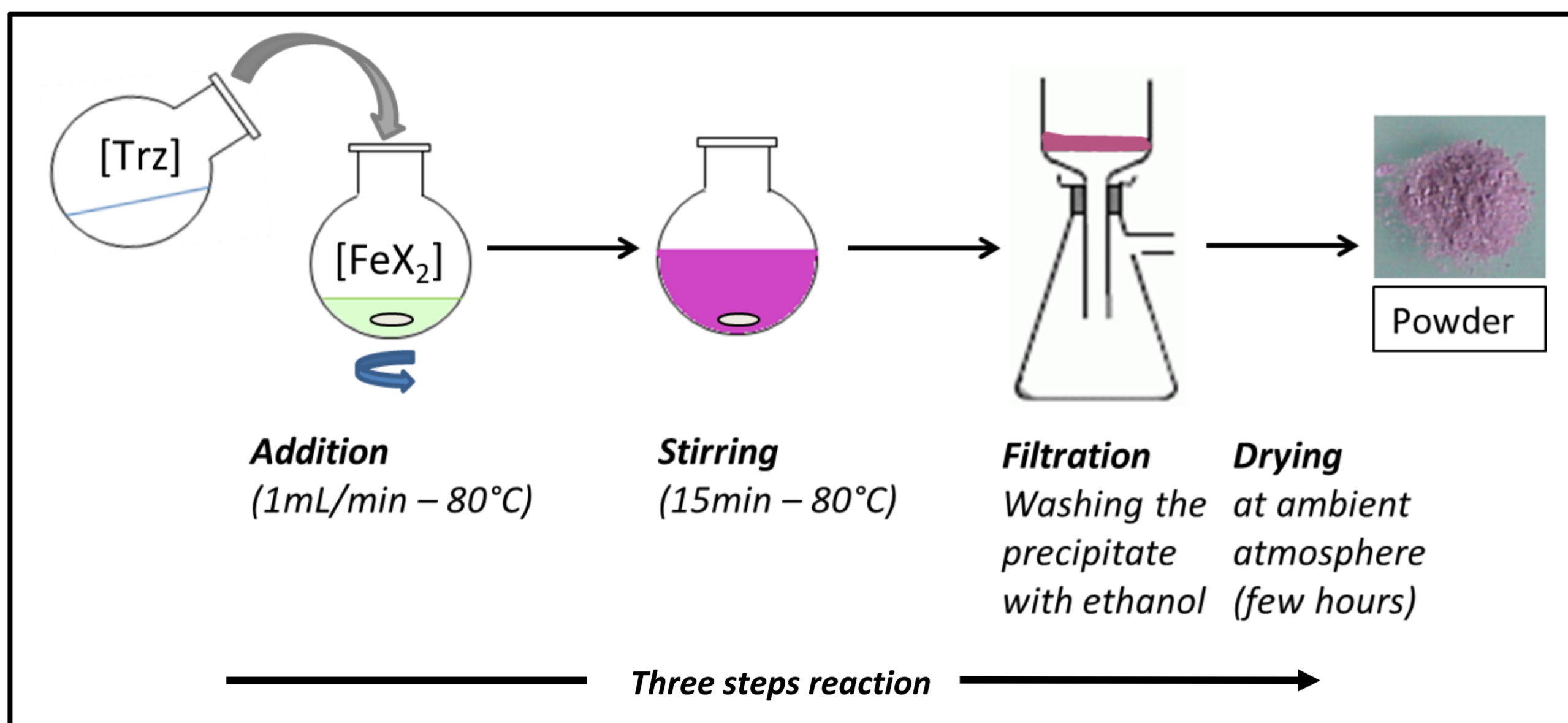

Batch synthesis of [Fe(Htrz)<sub>2</sub>(trz)](BF<sub>4</sub>)

### Flow chemistry approach

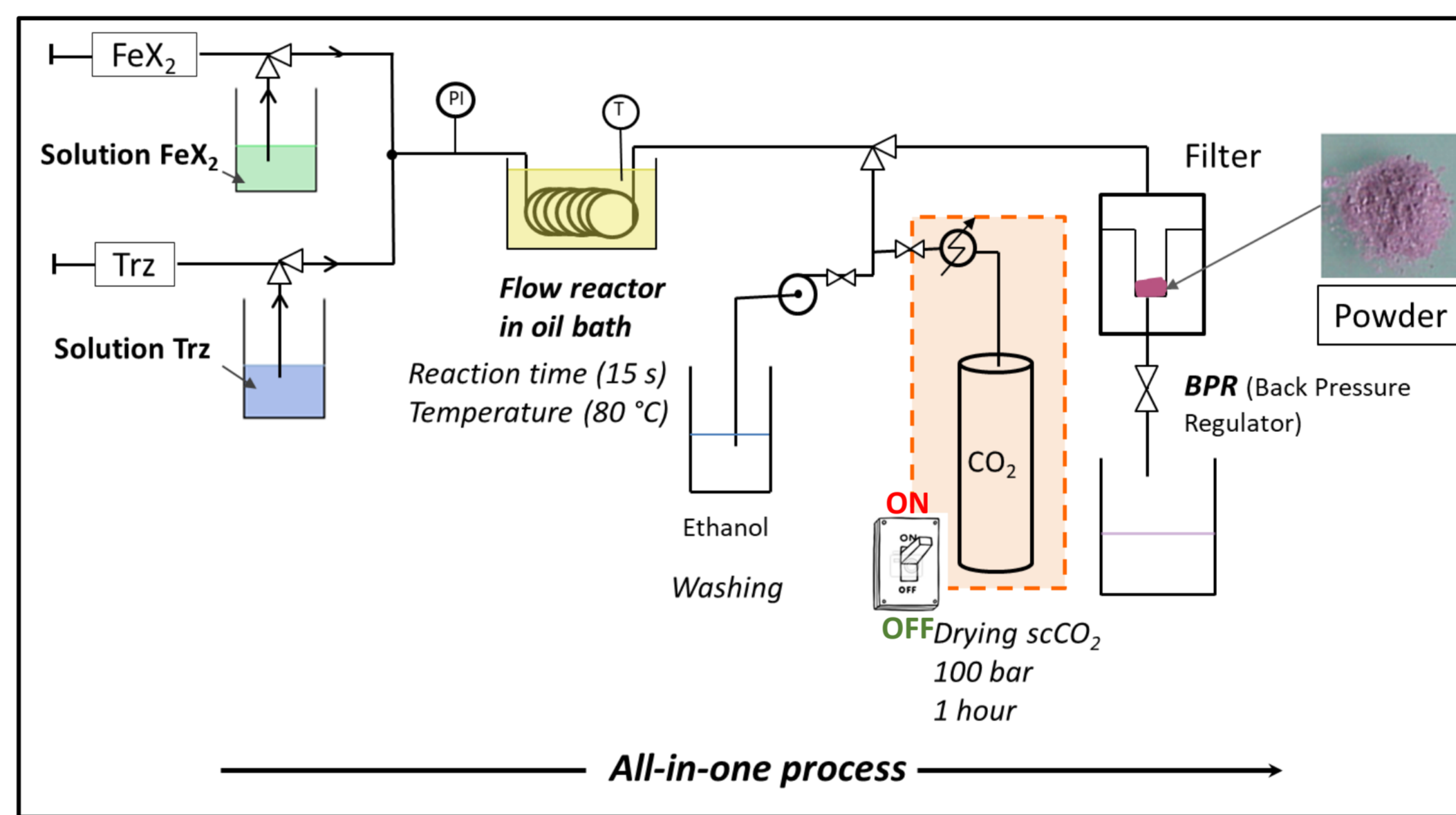

Flow synthesis of [Fe(Htrz)<sub>2</sub>(trz)](BF<sub>4</sub>) with supercritical CO<sub>2</sub> drying  
OFF (3 steps) – ON (1 step)

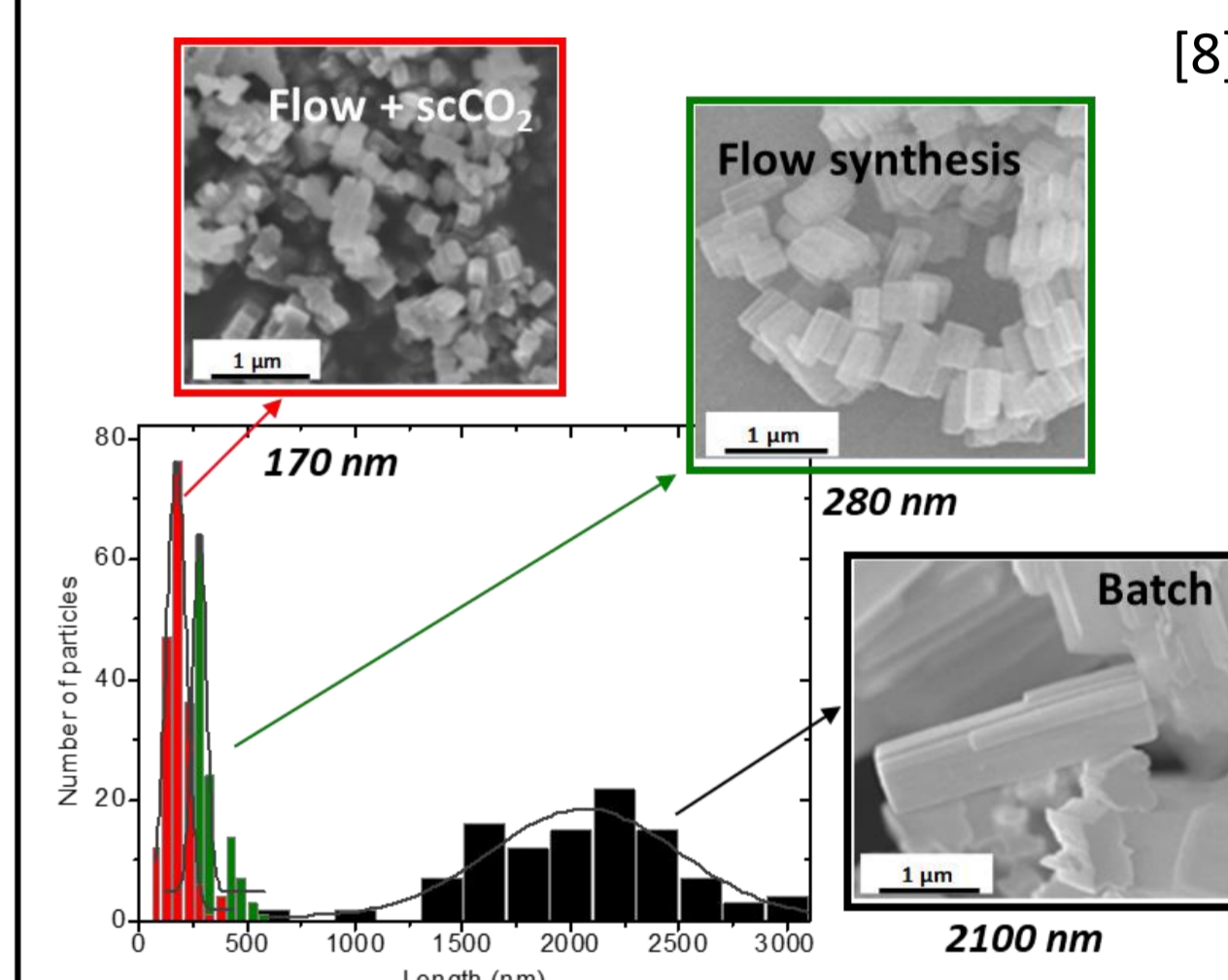

### Batch limitations

- Low quantities.
- Unreliable reproducibility from batch to batch.
- Long synthesis duration.
- Large sizes of particles.

### Advantages of the flow process

- Large quantities.
- Reproducibility.
- Short residence times.
- Small size and narrow size distribution.

### Process flow

- Co-flow of scCO<sub>2</sub> and ethanol.
- Washing step with ethanol.
- Supercritical drying with CO<sub>2</sub>.

## Results [8]

### SEM/TEM

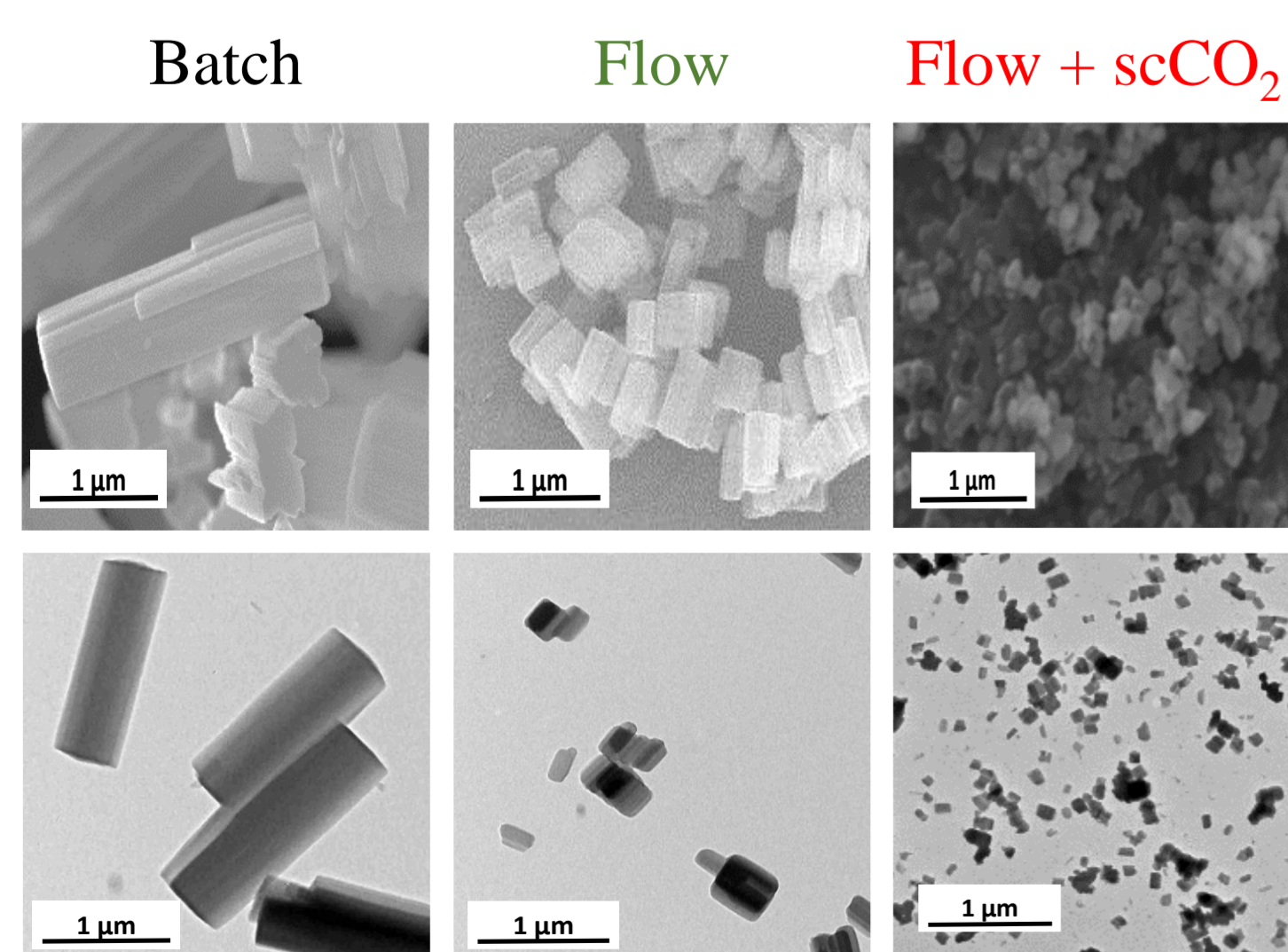

➤ 5-10-fold downsizing achieved

### Magnetic properties

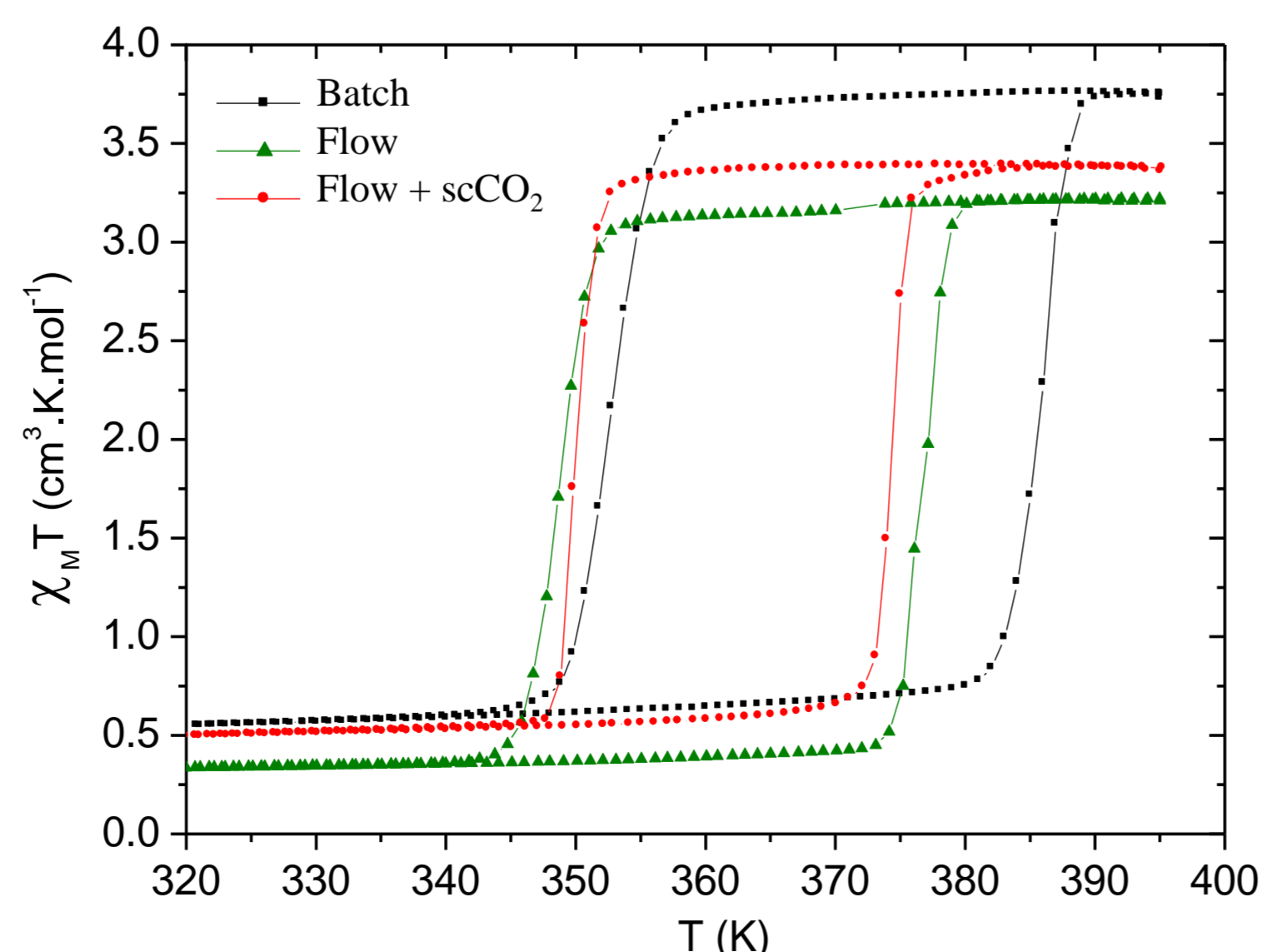

➤ Conservation of the switching properties

## Current and future work

### Particles formation hypothesis

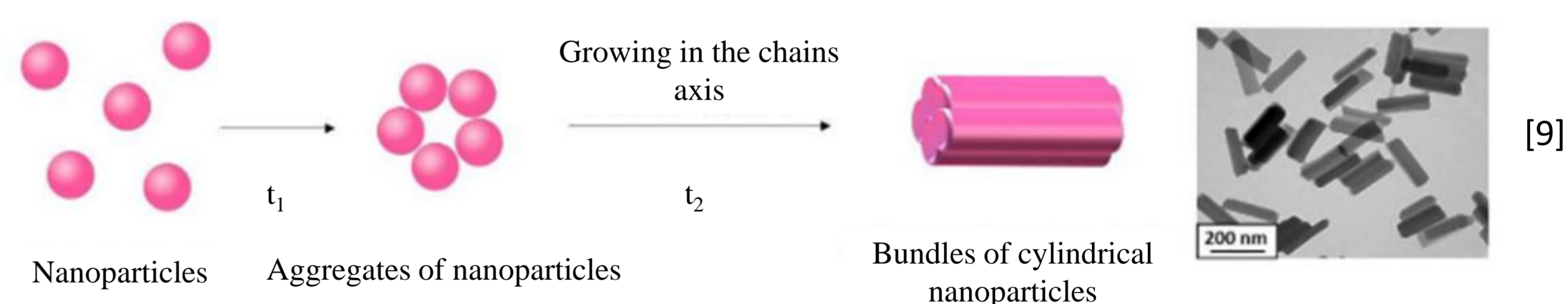

### Control of the NP growth

- Identification of t<sub>1</sub> (in situ DLS, pH probe, in situ Raman, etc.)
- Study of parameters of influence (concentration of reactants, temperature, synthesis duration, etc.)

### Extension to other materials

- Other [Fe(Rtrz)<sub>3</sub>]X<sub>2</sub>.
- Solid solutions (of ligands or anions).
- Heterostructures.

