



**HAL**  
open science

# Wavepacket Modelling of Jet-Flap Interaction Noise: from Laboratory to Full-Scale Aircraft

Jérôme Huber, Grégoire Pont, Peter Jordan, Michel Roger

► **To cite this version:**

Jérôme Huber, Grégoire Pont, Peter Jordan, Michel Roger. Wavepacket Modelling of Jet-Flap Interaction Noise: from Laboratory to Full-Scale Aircraft. *Flow, Turbulence and Combustion*, 2024, 113 (3), pp.773-802. 10.1007/s10494-023-00519-x . hal-04762072

**HAL Id: hal-04762072**

**<https://hal.science/hal-04762072v1>**

Submitted on 31 Oct 2024

**HAL** is a multi-disciplinary open access archive for the deposit and dissemination of scientific research documents, whether they are published or not. The documents may come from teaching and research institutions in France or abroad, or from public or private research centers.

L'archive ouverte pluridisciplinaire **HAL**, est destinée au dépôt et à la diffusion de documents scientifiques de niveau recherche, publiés ou non, émanant des établissements d'enseignement et de recherche français ou étrangers, des laboratoires publics ou privés.

# Wavepacket modelling of jet-flap interaction noise : from laboratory to full-scale aircraft

Jérôme Huber<sup>1\*</sup>, Grégoire Pont<sup>2</sup>, Peter Jordan<sup>3</sup> and Michel Roger<sup>4</sup>

<sup>1\*</sup>Aeroacoustic Sources, Airbus Operations SAS, Toulouse, France.

<sup>2</sup>Modelling and Simulation, Airbus, Toulouse, France.

<sup>3</sup>PPRIME Intitute, Université de Poitiers, Chasseneuil du Poitou, France.

<sup>4</sup>Centre Acoustique, École Centrale de Lyon, Ecully, France.

\*Corresponding author(s). E-mail(s): [jerome.huber@airbus.com](mailto:jerome.huber@airbus.com);

Contributing authors: [gregoire.pont@airbus.com](mailto:gregoire.pont@airbus.com);

[peter.jordan@univ-poitiers.fr](mailto:peter.jordan@univ-poitiers.fr); [michel.roger@ec-lyon.fr](mailto:michel.roger@ec-lyon.fr);

## Abstract

**Purpose:** A key component of aircraft acoustic installation effects relevant for under-wing turbofan-powered airliners, is studied: jet-flap interaction noise.

**Observations:** First, noise measurements performed on laboratory jets and on realistic engine exhaust geometries are analyzed to gain understanding both on surface pressure in the jet near-field and on far-field acoustics. The analysis of experimental datasets at various scales underlines intense, advecting, coherent and exponentially-growing pressure signatures in the jet near field and on the wing under-side. The outcome confirms our hypothesis for the main mechanism driving jet-flap interaction noise : coherent organized turbulent structures.

**Methods:** Relevant physical models are selected and chained together. RANS CFD and stability analysis model the characteristics of jet wavepackets as noise sources, analytical tailored Green's functions and Boundary Element Method (BEM) predict the diffraction of the wavepackets by the airframe.

**Results:** For academic configurations where a flat plate models the wing and flap, the wavepacket model is found able to capture noise directivity and trends. The significant impact of a swept trailing edge and the contributions of other plate edges lead us to design, test and

2 *Wavepacket modelling of jet-flap interaction noise*

simulate a plate with realistic wing plan form. The wavepacket-BEM simulation reproduces jet-surface interaction for the wing plan-form plate, as well as jet-flap interaction on realistic models tested at ONERA CEPRA19 facility during large-scale wind-tunnel tests. Wing-mounted unsteady pressure sensors are utilized as first control points. Then, polar and azimuthal acoustic directivity is examined. Discrepancies between experiments and simulations are identified. Finally an installation geometrical effect is computed: the vertical separation  $H$  between nozzle and wing is varied to replicate the tests. **Conclusion:** The diffraction of coherent organized turbulent structures generates jet-flap interaction noise in the academic jet laboratory, in large-scale wind-tunnel test and on the full-scale aircraft. We conclude on the potential and the limits of the proposed wavepacket-BEM model to predict the sound field, and we outline the perspectives for future modelling and testing.

**Keywords:** wavepackets, jet-flap interaction noise, stability analysis, BEM

## 1 Nomenclature

|             |   |       |
|-------------|---|-------|
| $a_0$       | Ambient speed of sound                                | (m/s) |
| $\alpha$    | Eigenvalue of local stability problem                 |       |
| $C$         | Wing chord  | (m)   |
| $D$         | Nozzle jet diameter                                   | (m)   |
| $D_{p/s/m}$ | Primary/secondary/fully-mixed jet diameter            | (m)   |
| $f$         | Frequency   | (Hz)  |
| $H$         | Radial separation between jet and flap trailing edge  | (m)   |
| $JFI$       | Jet Flap interaction                                  |       |
| $k_a$       | Acoustic wavenumber                                   | (m)   |
| $k_h$       | Axial convective or hydrodynamic wavenumber           | (m)   |
| $L$         | Axial separation between jet and flap trailing edge   | (m)   |
| $\lambda_a$ | Acoustic wavelength                                   | (m)   |
| $\lambda_h$ | Wavepacket hydrodynamic wavelength                    | (m)   |
| $M, M_j$    | Jet Mach number                                       |       |
| $M_{a,j}$   | Jet acoustic Mach number, $M_{a,j} = \frac{U_j}{a_0}$ |       |
| $M_c$       | Convection Mach number                                |       |
| $M_f, M_0$  | Flight Mach number                                    |       |

|               |   |                     |
|---------------|---|---------------------|
| $\nu$         | Kinematic viscosity                               | (m <sup>2</sup> /s) |
| $\omega$      | Angular frequency                                 | (rad/s)             |
| $\phi$        | Azimuthal angle, see Figure 5(a)                  |                     |
| PSD           | Power Spectral Density                            |                     |
| PSE           | Parabolized Stability Equations                   |                     |
| $\rho$        | Density (kg/m <sup>3</sup> )                      |                     |
| $\rho_0$      | Reference density in medium (kg/m <sup>3</sup> )  |                     |
| Re            | Reynolds number, $Re = \frac{UD}{\nu}$            |                     |
| St            | Strouhal number, $St = \frac{fU}{D}$              |                     |
| $T_{s,j}$     | Static jet temperature                            | (K)                 |
| $T_{t,j}$     | Total jet temperature                             | (K)                 |
| $T_0$         | Static ambient temperature                        | (K)                 |
| $t+$          | Convective time $t+ = \frac{tU_j}{D_j}$           |                     |
| $TE$          | Trailing edge                                     |                     |
| $\theta$      | Polar angle, 0 points downstream, see Figure 5(a) | (°)                 |
| $U, U_j$      | Jet mean velocity                                 | (m/s)               |
| $U_c, U_\phi$ | Convection or phase velocity                      | (m/s)               |
| $U_{p/s/m}$   | Primary/secondary/fully-mixed mean jet velocity   | (m/s)               |
| $\mathbf{x}$  | Observer position                                 |                     |
| $\mathbf{y}$  | Source position                                   |                     |

### Reference system

This study uses the coordinate system presented in Figure 5, from Piantanida *et al.*[1]. The polar angle  $\theta$  is relative to the jet axis with 0° pointing downstream. The azimuth angle  $\Phi$  is set to 0° in the spanwise direction of the wing on the starboard side of the aircraft.

## 2 Introduction

Understanding and predicting jet-flap interaction noise is the main focus of this work. Jet-flap interaction (JFI) noise is a component of *installed jet noise*, the term used here to describe the total noise due to an engine jet installed on an airframe. *Propulsion-Airframe Aeroacoustics* (PAA) is a synonym also found in the literature. Figure 1 illustrates key parameters to consider for JFI noise in the case of a jet engine installed under wing. The engine integration is here described using the nozzle and jet diameters  $D_m$ , and the installation geometry with distances H and L. Installed jet flow dynamics include features

such as jet redirection by the wing and passage under the flap at an effective radial distance  $H_{\text{eff}}$ .

We refer to *installation effects* as the difference in sound pressure level between installed and isolated nozzle configurations. A separation of aeroacoustic installation effects into source and propagation mechanisms is proposed. Three *source* mechanisms are envisaged as (1) jet noise sources responsible for direct sound radiation may be modified due to the mean flow deformation caused by installation; (2) jet-flap interaction (JFI) noise, also called jet-surface interaction (JSI) noise in the case of simplified configurations with flat plates. Jet-flap interaction is due to jet near field scattering by the lifting wing as the jet flow passes close to the surface and particularly to the trailing edge. This interaction creates broadband noise; (3) jet-flap impingement is expected to create broadband noise and possibly tonal noise via resonances. Additionally two *propagation* mechanisms are expected to influence the installed jet far-field signature: (1) jet-surface reflection of acoustic waves is expected to increase noise particularly at medium and high frequencies, (2) jet acoustic blockage shields the flyover observers from reflected waves and redirects energy to lateral directions.

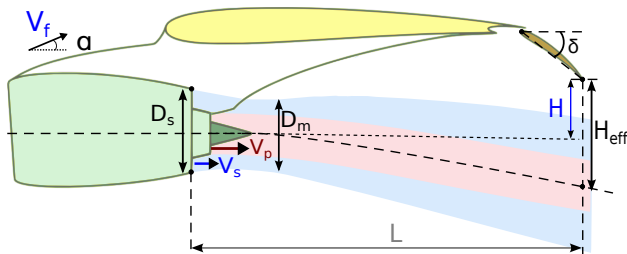

**Fig. 1** Problem definition of the installed co-axial jet, including the main parameters used in this work. The sketch uses an earlier work by Lawrence [2].

Jet installation noise has been studied extensively since the 1970s, with numerous reports of measured noise directivity and trends at different scales and complexity levels. However modelling attempts of the noise generation mechanisms are mostly recent and fewer in number.

Jet-flap interaction noise has been identified in dedicated flight tests, first on a DC-10 as reported by Low [3] and later on a 707 CFM56 by Sengupta [4]. On the DC-10, Low identified the noise source in the frequency range [50, 250] Hz, typically  $St \in [0.2, 1]$ . A significant noise increase was measured when the jet impinged on the flap at approach conditions, at which the flap is deflected at an angle greater than  $30^\circ$ .

In the 1970s Head and Fisher [5] reported on lab tests performed with a single-stream jet and flat plate. Scattering of the jet near field at the wing trailing edge (TE) was recognized even when the jet was not "*ostensibly interacting with*" the plate. They concluded that a jet-plate interaction noise source

could be modelled as a dipole perpendicular to the plate, located at the trailing edge and suggested it was driven by local near-field *acoustic* pressures. Similar experiments and conclusions repeated in the recent years with Cavalieri *et al.*[6] and Piantanida *et al.*[1], except for the near-field pressure was now proved to be non acoustic but hydrodynamic.

In the early 1980s numerous studies focused on scaled-model experiments in wind tunnels. A main motivation was to explain the noise gaps identified between full-scale aircraft hence an installed propulsion system, and scaled models of engine exhausts tested in simulated flight conditions but isolated. A number of reports e.g. Bushell [7], Reddy and Tanna [8], Southern [9], Way and Turner [10] and Wang [11] showed that installation effects cause low-frequency amplifications that explain part of the noise measured in aircraft flight tests. SenGupta [4] and Miller [12] studied installed scaled models including a realistic 1:13-scale B757 model in the Boeing company wind-tunnel. SenGupta suggested that the noise amplification due to installation was due to lift fluctuations at low frequency, trailing-edge diffraction at mid frequency and jet noise reflection at high frequency. A significant contribution of Miller [12] is the identified role of the wing leading edge in the diffraction process. The ratio between wing chord and acoustic wavelength  $C/\lambda$  drives the multi-lobe directivity shape. Miller proposed an empirical model for JSI polar directivity to account for the interference between two acoustic waves originating from the trailing edge and travelling upstream, one above and the other below the wing. Lawrence [13] recently corroborated Miller's model with flat plate laboratory data in static conditions. Shearin [14] and Brown and Ahuja [15] identified the influence of various airframe geometrical features and installation parameters on total noise. Noise increases when (i) vertical separation  $H$  is lowered, (ii) axial separation  $L$  is increased, (iii) flap deflection  $\delta$  is increased (reducing  $H$ ), (iv) flap cut-out width is decreased, and when (v) jet velocity is increased. Shivashankara and Blackner [16] published an extensive reduced-scale model test representing a large airplane, at the LSAF wind-tunnel facility [17, 18]. Source imaging confirmed the importance of the flap trailing edge downstream of the engine.

In the 2000s, Elkoby [19] studied installed jet noise at full scale by comparing flight tests measurements and engine data projected to flight without installation effects. Noise increases at takeoff turned out to be similar to wind-tunnel results, yet the source mechanisms were not inferred. Mengle *et al.*[20–23] used an out-of-flow source location technique to interpret the effect of chevron and flaperon designs on jet-flap interaction noise. Asymmetric chevrons with enhanced mixing near the pylon were found more effective at reducing JFI noise than symmetric chevrons. Jet flow distortion under wing and the effectiveness of serrations at reducing JFI were experimentally quantified in coaxial nozzle wind-tunnel tests at ONERA CEPRA19 [24] and reported by Davy [25], Dezitter *et al.*[26] and Huber *et al.*[27]. Subsequent investigations at CEPRA19 reported by Huber *et al.*[28], David *et al.*[29] and Fleury and Davy [30] confirmed the three-source view formulated above. The

jet was found to dominate the unsteady fluctuating pressure in measurements on the wing and flap underside. The data demonstrated the organisation and the exponential growth of unsteady wall pressure in the streamwise direction even in complex geometries with pylon. Meloni *et al.*[31] analysed some of the unsteady wall pressure measurements at CEPRA19 in both static and flight conditions and confirmed wavepackets signature on the wing model.

Our objective is two-fold. Our first aim is to establish the importance of organized turbulence structures for jet-flap interaction noise across a wide range of scales all the way to the commercial aircraft, through both published and novel experiments. Our second objective is to assess how a simplified physics-based modelling approach may characterize JFI noise for various designs and levels of complexity, including realistic geometries.

The remainder of this paper is organized as follows. In 3 we present the different experimental set-ups and a data analysis for the near-field and the far-field pressure. We propose a simplified modelling methodology in 4 and assess it against tested cases of increasing complexity levels in 5. Some concluding notes are proposed in 6.

## 3 Jet Installation Noise Measurements

This section presents noise measurements performed at different scales: full-scale experiments on an aircraft in flyover, realistic wind-tunnel tests, and jet laboratory tests on a canonical jet plate configuration. First, each test is described. In a second step, the free-field measurements are presented. Pressure data recorded in the source near field is analyzed next. Finally conclusions and perspectives for noise source modelling are proposed.

### 3.1 Tests description

Full-scale flyover tests are presented first. Then the jet installation problem is replicated at a reduced scale in a large anechoic wind tunnel. At last the problem is further simplified into a canonical configuration: laboratory tests are conducted with flat plates interacting with a single-stream nozzle jet.

#### 3.1.1 Flight tests

This section presents acoustic measurements performed by Airbus during two flight test campaigns on widebody A350 aircraft. This twin-jet airliner is equipped with a Rolls-Royce Trent XWB engine[32] of ByPass Ratio around 10. A first test campaign focused on jet-flap interaction noise characterization in the *far field* with ground microphones and source localization array. The second campaign characterized the *near-field* wall pressure fluctuations on the wing pressure side of the same aircraft model.

Flyover noise tests and instrumentation are illustrated in Figure 2. For the far-field noise measurements during flyovers, ground microphones are placed

on plates of large scale to mitigate ground effects and with a daisy design to reduce edge diffraction [33, 34].

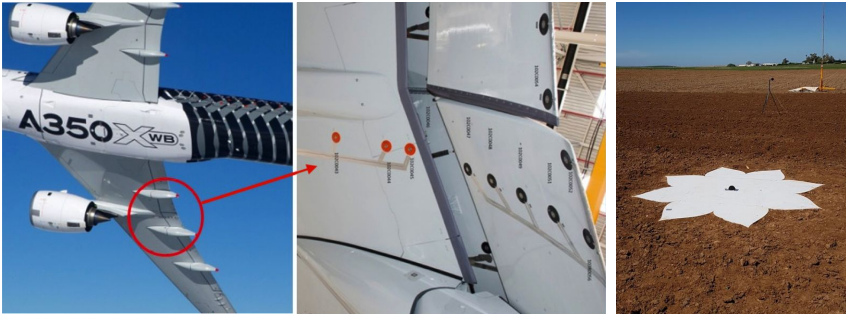

**Fig. 2** A350 aircraft, on-board instrumentation and ground microphone on daisy plate. The on-board microphones are flush-mounted at the center of round elastomer pads, of red color on the main wing and black on the flaps. Pictures are Airbus copyright.

The near-field test campaign aimed at measuring the unsteady surface pressure under wing in conditions replicating the far-field tests. Thirteen microphones were installed on the pressure side of the right hand-side wing, downstream from the engine as shown in Figure 2. These microphones can be grouped into a streamwise array and a spanwise array. The streamwise set is located on an axis parallel to the engine axis  $0.3 D_m$  outwards of the pylon symmetry plane, includes three microphones on the wing and five microphones on the flap. The spanwise set of sensors is located along the trailing edge of the flaps.

### 3.1.2 Wind-tunnel tests

A series of wind-tunnel tests performed by ONERA at the CEPRA19 facility [24] are used. The two tests EXEJET and AMBROSIA were performed in the frame of a partnership between Airbus and Safran Aero Engines. The JERONIMO test was in the frame of a partnership between Airbus, Rolls-Royce Deutschland, Safran Aero Engines and ONERA. These large-scale jet noise tests use realistic geometries and flow conditions, and allow exploring the aeroacoustic phenomena at play at full scale [35]. The CEPRA19 tunnel convergent delivers a two-meter diameter coflow stream that replicates the aircraft flight condition at any specified Mach number up to 0.3. The nozzle models are dual-stream coaxial geometries, have a typical nozzle diameter of 20 cm, and can be used either with a pylon model or in an axisymmetric configuration. The Airbus REX80 wing model was designed specifically for this wind tunnel. The wing chord at the powerplant station is in the range  $D_m \in [2, 3]$  pending on nozzle model and conditions in those tests. The wing TE is at a sweep angle of  $7^\circ$ . Additional details on the test set-up and on the wing model may be found in [28].



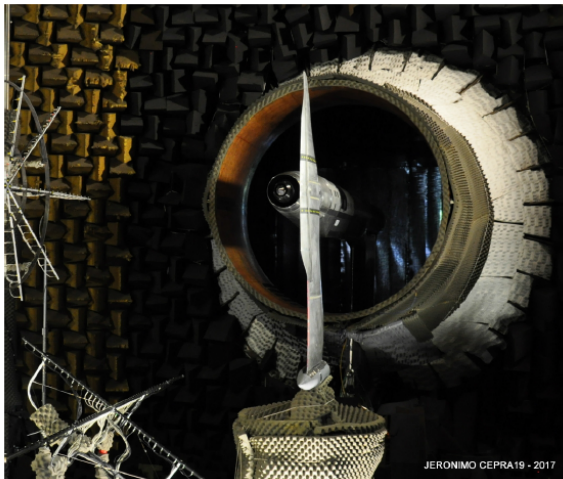

**Fig. 3** Axisymmetric nozzle and REX80 wing model in CEPRA19, Onera. JERONIMO test campaign. Airbus ONERA Rolls-Royce Safran collaboration.

During the AMBROSIA wind-tunnel tests, model configurations simulated various nozzle-to-wing distances, thus allowing to study the influence of the installation geometry on jet-flap interaction noise. Installed configurations were tested over a significant range of  $H/D$  values by translating the wing model up and down relatively to the axisymmetric nozzle model. A model deformation measurement system by ONERA based on triangulation provided the nozzle and wing positions in test chamber in real time. The  $H$  values achieved could therefore be assessed with high accuracy.

While CEPRA19 has the capability to generate realistic heated dual-stream engine jets, matched-jets conditions were also achieved to effectively create a dual-stream jet flow similar to a single stream. At matched-jets condition, the Mach numbers for the primary jet ( $j, p$ ) and secondary jet ( $j, s$ ) are equal,  $M_{j,p} = M_{j,s}$ , and so are the static temperatures  $T_{j,p} = T_{j,s} \simeq T_0$ . Noise data was acquired with the 2-meter flight stream, and also at static ambient conditions by turning off the flight stream.

### 3.1.3 Simplification of the problem

Studying jet-flap interaction noise on a canonical geometry implies conserving the physics at play at larger scale. The use of a reference single-stream jet and flat plates to simulate the wing and flaps has been done repeatedly. This degree of simplification turns out to be adapted to our study focused on high-bypass ratio turbofans. For these engines, the mass flow in the secondary duct is about ten times higher than in the core. The secondary jet velocity is expected to drive the most intense near-field fluctuations, although caution must be taken as the primary jet may drive a downstream part of the near field when primary jet velocities are high, as reported Léon and Brazier [36].

The dual-stream jet is therefore simplified with a single-stream jet of diameter  $D = D_m$  and  $U = U_s \simeq U_m$ .

A dimensional analysis can conclude on the main parameters driving jet-flap interaction noise : Equation 1 presents flow and geometrical variables at play. In terms of installation geometry, the engine exhaust is typically close to the wing leading edge therefore  $\Delta x \ll D$ . This yields that the axial separation is about equal to the wing chord,  $L \simeq C$ . Typical axial separation distances  $L$  for modern commercial aircraft are in the range  $[2D_m, 6D_m]$ . The engine is installed at a vertical distance  $H$  from the flap edge, and the wing lift modifies the vertical separation to an effective  $H_{\text{eff}}$ . Steady CFD is expected to be able to provide  $H_{\text{eff}}$  hence this parameter can replace both  $H$  and lift coefficient  $C_L$ . Wing are typically thin in the sense that  $\epsilon \ll C$  therefore  $\epsilon < \lambda$ . Wing thickness may therefore be neglected and Lawrence [13] and Piantanida [37] have confirmed this hypothesis experimentally. The wing-flap gap distance is also very small compared to  $\lambda$ . Finally, wing camber is neglected despite the flap deflection  $\delta$ , moderate on take-off configurations, to propose a flat plate representation of the wing. The parameters in Equation 1 is therefore reduced to two velocities and three characteristic lengths in Equation 2.

$$\begin{aligned} SPL &= f(U_p, U_s, U_f, D_m, H, L, C, C_L, \delta, \epsilon, \text{planform}), & (1) \\ &\simeq f(U_s, U_f, D_m, H_{\text{eff}}, L, \text{planform}). & (2) \end{aligned}$$

These reduced parameters justify that a flat plate interacting with a single-stream jet may be used to gain understanding on jet-flap interaction aeroacoustics. Various vertical separations  $H$  and two plate planforms are studied next.

### 3.1.4 Jet Laboratory tests

The experiments were performed in the *Bruit et Vent* anechoic facility of the PPRIME Institute, Poitiers, France. The anechoic chamber has dimensions of  $9.6 \text{ m} \times 6 \text{ m} \times 3.4 \text{ m}$ , and is equipped with absorbing foam of depth  $0.4 \text{ m}$ . The cut-off frequency is  $212 \text{ Hz}$ . The nozzle of diameter  $D = 0.05 \text{ m}$  was used in a number of investigations [6, 38, 39] where the flow and sound fields have been extensively studied in an uninstalled configuration. The acoustic Mach number, defined as  $M = U/a_0$ , with  $U$  the mean jet velocity at nozzle exhaust and  $a_0$  the ambient speed of sound, was varied in the range  $0.4 \leq M \leq 0.9$ . The jet was isothermal,  $T_{sj}/T_0 = 1$ , and a boundary layer trip placed  $2.7D$  upstream of the nozzle lip ensured a fully turbulent boundary layer at the jet exit.

Flat aluminum plates with varying trailing-edge sweep angle were mounted with their flat surface parallel to the jet. Plates spanned  $15D$  and the mid-span chord was fixed at  $9D$ . The plate thickness was  $0.06D$ . The plate leading edge was clamped to a support that allows the plate to be moved in the

radial direction, with respect to the jet axis. The mid-span of trailing edge is situated at  $L/D = 4$  from the nozzle exhaust plane in the jet flow direction as illustrated in Figure 5. For each sweep angle  $\beta$ , the radial position of the plate and the jet Mach number were varied in order to explore the effect of each parameter on the sound field. Parameters space covered the sweep angle range  $0^\circ \leq \beta \leq 45^\circ$ , Mach number range  $0.4 \leq M \leq 0.9$  and jet-plate radial distance range  $0.6 \leq H/D \leq 2$  from the jet center line.

The minor effect of the plate on the jet mean flow for distances  $H/D \geq 1$  was verified experimentally by Cavalieri *et al.*[40] and our RANS CFD on the same jet-plate cases confirmed this fact.

Piantanida and Jaunet performed extensive acoustic measurements using an 18-microphone azimuthal array of radius  $r/D = 14.3$  hence in the geometrical near field. The sound field was mapped on a cylindrical surface surrounding the jet-plate system. Figure 4 presents two pictures of the experimental setup: Figure 4(a) shows the microphone measurement array traversing around the models. Figure 4(b) illustrates the plate and the nozzle location. Additional details on the experimental setup may be found in [1].

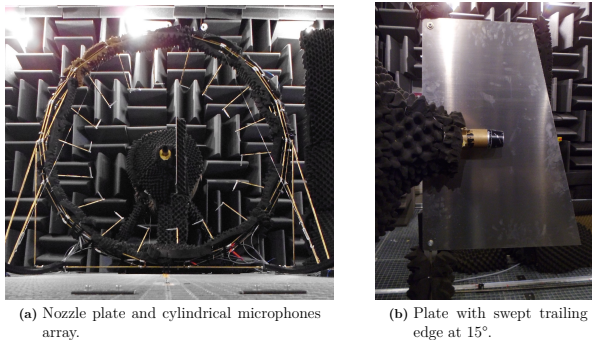
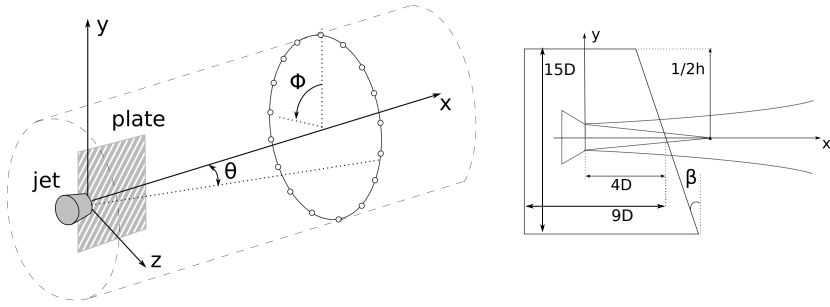

**Fig. 4** Jet-plate experiment at Bruit et Vent, PPRIME, by Piantanida and Jaunet. Pictures are Airbus and PPRIME copyright.

A sketch of the experimental layout is provided in Figure 5, including the reference coordinate system, the polar ( $\theta$ ) and azimuthal ( $\phi$ ) angle conventions used.

### 3.2 Analysis of far-field measurements

Aircraft flyover test data is presented first. An analysis of wind-tunnel test data follows, and a comparison of datasets concludes with a broad range of model scales.



**Fig. 5** Sketch of the experimental layout: jet-plate system, measurement surface and coordinate system conventions (left), plate characteristics and position (right). From Piantanida *et al.*[1]

### 3.2.1 Flight test results

For a typical takeoff engine power condition, a measurable noise level increase in the forward arc was identified when the flap is deflected toward the jet, similarly to previous flight tests with DC-10 and B707 [3, 4]. Fig. 6 presents two spectra associated with distinct flap deployments, all other relevant flight parameters being reproduced. The noise increase of 4 to 5 dB in the frequency range  $St_m \in [0.3, 1]$  is attributed to jet-flap interaction noise. While limited in resolution at such low frequency, the processing of the ground-based source localization array data at  $St_m = 0.7$  indicated a source region near the flap becoming more intense with increased flap deflection. The noise levels also increase at higher frequency  $St_m > 1$ , with other installation effects being possible contributors.

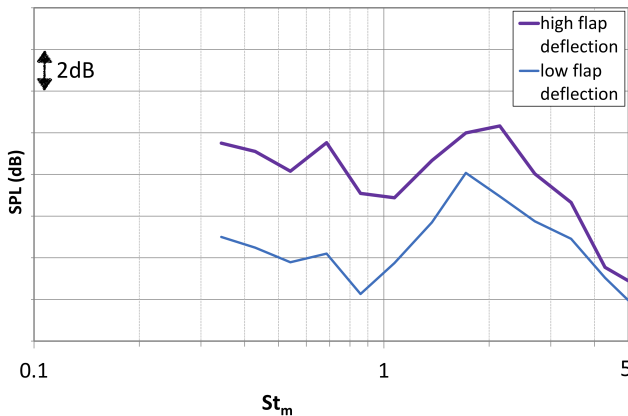
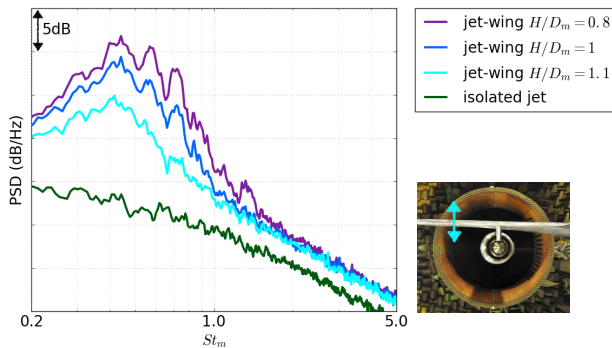

**Fig. 6** Acoustic narrowband pressure spectra measured at  $\theta = 130^\circ$  for two flap deflections. Takeoff engine power condition. A350 flight test campaign. Airbus copyright.

### 3.2.2 Wind-tunnel test results

Free-field noise spectra for installed and uninstalled nozzles measured by a forward-arc microphone are presented in Figure 7. The distance between the REX80 wing and the axisymmetric nozzle was varied in the range  $H/D_m \in [0.8, 1.1]$ . The sound amplification up to 15 dB observed at  $St_m \in [0.2, 1.5]$  increases with a reduced radial distance  $H/D_m$ . The frequency range at which the amplification occurs above 3 dB increases with decreasing  $H$  distance. This amplification is attributed to jet-flap interaction noise. The noise increase in the frequency range  $St_m \in [1.5, 5]$  lies between 2 to 3 dB and is attributed to jet noise reflection by the wing. The array analysis reported by Fleury *et al.*[30] confirmed this scenario, with strong source activity identified near the flap trailing edge at  $St_m = 1$ , and source activity in the jet plume and reflected sound image at  $St_m \geq 2$ .

Figure 8 presents the sound directivity of two frequencies for a model configuration tested in wind tunnel, where  $H/D_m \simeq 1$ . While the isolated nozzle jet displays the classical aft directivity of direct jet noise with a dynamic of 10 to 15 dB, jet-flap interaction noise dominates the installed jet signature in the forward arc with a 10 to 20 dB amplification. Jet-flap interaction noise appears to have a marked forward-arc directivity at most frequencies. Overall, the CEPRA19 measurements used in this study confirm the broadband noise amplification shown in previous publications, for instance Mead and Strange[41], Mengle[23], Cavalieri *et al.*[6].



**Fig. 7** Acoustic narrowband pressure spectra measured near the peak of installation noise in CEPRA19 at  $\theta = 130^\circ$  for different vertical distances  $H/D$ . Unheated nozzle flows at a typical takeoff operating point in static conditions. AMBROSIA test campaign.

A comparison between this large-scale data, the flight test data and jet laboratory tests results is proposed next.

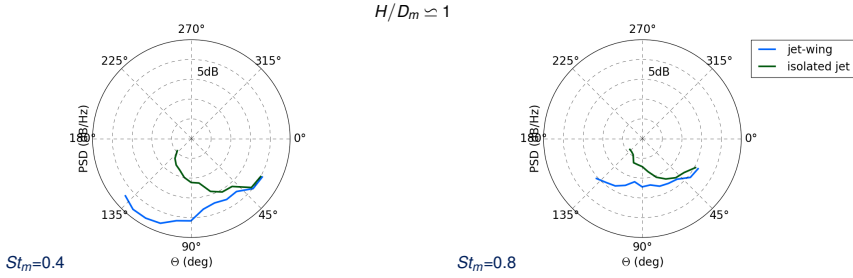

**Fig. 8** Polar directivity of sound pressure levels measured in CEPRA19 in flyover direction for a  $H/D_m \simeq 1$  configuration with axisymmetric nozzle and REX80 wing model.  $M_j = 0.6$ , unheated matched jets, static conditions. AMBROSIA test campaign.

### 3.2.3 Comparison of measurements from the different scale experiments

Figure 9 confirms the similarity of far-field noise signature for jet-plate interaction and for jet-flap interactions in wind tunnel and in flight. The free-field noise measurements confirm trends observed on conventional jet-airframe interaction in previous publications [21, 23, 27]. Conventional jet-airframe interaction noise tends to dominate at low Strouhal numbers  $St_m \in [0.3, 1.5]$  and forward polar angles. On top of the largely broadband spectrum several narrow peaks emerge. Closely-coupled systems may generate marginally extra low-Strouhal broadband noise, but significant additional noise at mid Strouhal numbers  $St_m \in [1, 3]$  and emerging tones. Broadband noise trends at low- and at mid-Strouhal ranges are coherent between the academic jet-plate case, the wind-tunnel cases and the flight tests, providing a further justification for the study of canonical jet-plate systems.

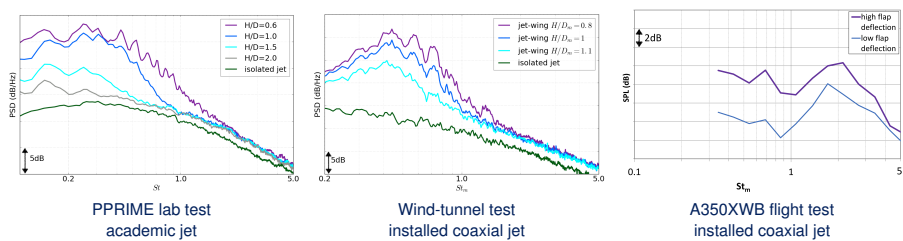

**Fig. 9** Jet installation noise measured at different scales.

## 3.3 Analysis of near-field surface pressure measurements

The wall pressure measurements on realistic geometries are analysed first, and then compared to the findings of academic studies.

### 3.3.1 Wing Surface Pressure results from Full- and Large-Scale Tests

Groups of wall-mounted sensors are considered in flight tests and in large-scale wind-tunnel tests. Figure 10 presents results of both tests, where the time history of the fluctuating pressure is plotted against the streamwise position of the sensors. On the left-hand side, the sensors are aligned in the spanwise direction, almost normal to the jet flow. In the center and on the right-hand side, the sensors are aligned with the main direction of the flow.

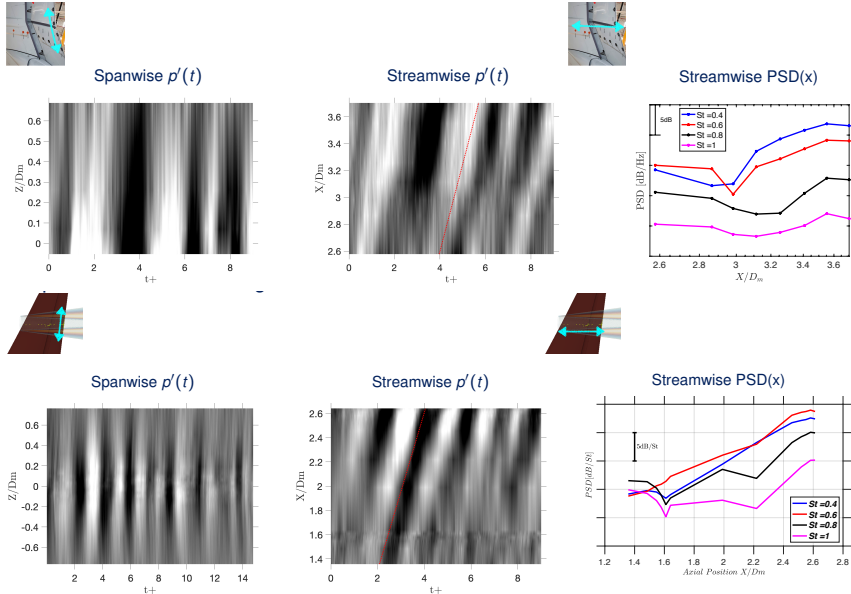

**Fig. 10** Unsteady surface pressure measured on the wing pressure side, (top) flight tests and (bottom) in wind tunnel tests. Airbus copyright.

A prior analysis of near-field wall pressure was conducted to validate the data quality. Both in flight and in wind tunnel, two different engine power settings are used: the idle power where the bypass jet mean velocity is close to flight velocity, and the takeoff power where  $M_s$  is close to 0.9. The pressure fluctuation levels between takeoff power and idle were found to be several orders of magnitude, see [28] for an illustration of the wind-tunnel case. At takeoff, the sensors measured significant fluctuation levels on the range  $St_m \in [0.3, 1.4]$ . An accentuated flap deflection increased the levels. These main observations are consistent between the aircraft and the reduced-scale models.

Spanwise fluctuations are intense and coherent. The energy peaks at the engine centerline and decreases as sensors are farther away spanwise. In the streamwise direction, fluctuations are correlated over the entire range of streamwise sensors, a distance greater than one jet diameter  $D_m$ . We conclude

that coherent structures impose their trace from the most upstream all the way to the most downstream microphone located near the flap trailing edge. The slope provides a convection velocity that is subsonic, much larger than the ambient flight stream velocity and around 0.65 times the fully-mixed jet velocity.

The evolution of power spectral density measured by the surface sensors over the stream-wise direction is also of interest in Figure 10. The axial growth of the levels is of the order of 15 dB over one  $D_m$ , for all four selected Strouhal numbers, and is roughly exponential for  $St = 0.4$  and  $St = 0.6$ . Such amplification is qualitatively similar to the growth of instabilities in the local framework, and identified in the case of canonical jets e.g by Breakey *et al.*[39]. To the authors' knowledge, the observation of the trace of jet coherent structures and their spatial growth on a full-scale aircraft in flight has not been published before.

### 3.3.2 Comparison of measurements at the different scales

The analysed unsteady pressure fields on the wing lower side are compared to measurements performed on academic single-stream jets and on isolated coaxial nozzle. Figure 11 proposes a summary of this comparison with (a) the isolated nozzle in a laboratory test facility, (b) coaxial nozzle in wind tunnel, (c) installed coaxial nozzle with pylon and wing and (d) the engine in flight test. The complexity of installed nozzle cases (c) and (d) is significantly larger with the presence of flight stream, three-dimensional features such as pylon and wing, and Reynolds numbers reaching values around 30 million. Yet the signature of coherent structure is found at all levels of complexity and at all scales. This finding is consistent with two recent reports. The first is a full-scale turbofan engine test at ground where Faranosov *et al.* [42] identified a low-order azimuthal structure in the jet sound field due to organized sources. The second is an investigation of jet noise on an aircraft in cruise: Aujogue *et al.* [43] showed that near-field acoustic pressure measured on the airplane fuselage was consistent with the shock-associated noise generated by jet wavepackets.

In spite of the large differences between the various test cases, the near-field and wall pressure signatures prove remarkably similar across the tested scales. They indicate that axially-organized structures develop in the mixing layers of installed jet and impose significant pressure fluctuations on the aircraft wing.

Furthermore, it has been shown in wind tunnel by Huber *et al.* [28] that unsteady pressures on the lower side and on the upper side of the flap are highly correlated, over a broad spectral range and in flight conditions. This observation substantiates the theory of the linear process of diffraction of the jet near field by the wing.

## 3.4 Conclusions and perspectives for modelling

We conclude that intense, coherent, advecting and exponentially-growing pressure signatures are measured on aircraft wing underside. The jet sources



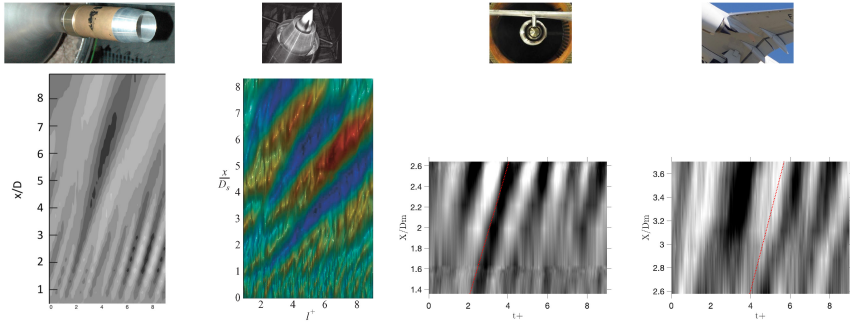

**Fig. 11** Jet near-field fluctuating pressure and surface pressure measured at different scales from the laboratory to the aircraft in flight. From left to right: Data from Breakey *et al.* [44]. Data from Tinney and Jordan [45]. EXEJET wind-tunnel test data [28]. A350 flight test data. Airbus copyright.

responsible for these signatures diffract at the flap trailing edge. Organized source models have the best chances to reproduce measured signatures and, coupled with a relevant propagator for diffraction, capture jet-airframe interaction noise. This potential appears relevant for the broad variety of cases and scales presented here, from the laboratory nozzle to the aircraft in takeoff flight.

## 4 Methodology

This section describes the methodology chosen and developed to study jet-flap interaction noise. A process is elaborated using a source model and a propagator.

### 4.1 Source modelling

The sound source model is chosen to be consistent with organized turbulent structures in the jet. Coherent structures are the product of instability mechanisms triggered on a base flow. Because the isothermal jet is a system that is absolutely stable and convectively unstable [46], our baseline stability analysis is resolved on a spatial domain using Local Stability Analysis (LST) and Parabolized Stability Equations (PSE), and these methods require a base flow.

#### 4.1.1 Base flow

The FLUSEPA solver is used to generate RANS solutions for the mean flow. FLUSEPA [47] is a solver developed by ArianeGroup for launcher propulsion. The turbulence model  $k-\omega$  with SST-Menter corrections is selected. The mesh includes 13 million cells and relies on the unstructured conservative Chimera capabilities of FLUSEPA.

### 4.1.2 Stability analysis

Stability analysis is a theoretical framework that can be used for studying how coherent structures evolve in space and time. Two simplified approaches are used to predict jet instabilities and form wavepacket source terms: Local Stability Analysis (LST) and non-local analysis by solving Parabolized Stability Equations (PSE). Weakly non-parallel stability analysis via PSE has been shown to predict the average wavepacket and the near pressure field of a mode 0 instability at  $St = 0.3$  [48]. The average wavepacket is not sufficient to produce the sound field of a free jet as the desynchronisation or jitter of wavepackets is a key factor for acoustic efficiency [49–51]. Nogueira *et al.* [52] have shown that this is the case also for jet-plate interaction noise when the plate TE is at four diameters downstream of the nozzle TE. But when the distance is shortened to three diameters, Faranosov *et al.* [53] have obtained absolute noise levels with satisfactory accuracy, suggesting that a perfectly-coherent wavepacket model might be sufficient for noise prediction at small  $L/D$ .

The CNRS-ITA PSE solver used in this work is based on developments by Guðmundsson [54] and Sasaki [55].

### 4.1.3 Source models

Noise generation in free and in installed jets can be modelled using aeroacoustic analogies, provided that the source model is physically relevant. We are therefore interested in modelling the Lighthill's stress tensor. Source terms are directly defined using a single-point formulation, with fluctuations predicted by stability analysis. The selection of source models is composed of a model informed by LST, and a model informed by PSE. Experimental data is required to fill in missing parameters in both models.

#### *Model with local stability data*

The case of an isothermal jet of moderate Mach number and at high Reynolds number simplifies the Lighthill's stress tensor by retaining the inertial term and neglecting the viscous term and the entropy fluctuations, to:

$$T_{ij} \approx \rho_0 v_i v_j. \quad (3)$$

Considering that the dominant term of  $T_{ij}$  is the product of mean and fluctuating velocities, and that the  $T_{xx}$  component dominates the downstream radiation in free field, the Fourier transform of Lighthill's tensor can be modelled as

$$T_{ij} \approx T_{11}(y_1, r, \phi, m, \omega) = 2\rho_0 \bar{U}_1(r) u'_1(r, m, \omega) e^{-ik_h(y_1 - y_{1c})} e^{-\frac{y_1 - y_{1c}}{L^2}} e^{im\phi}, \quad (4)$$

where  $\bar{U}_1$  is the mean velocity profile at  $x = D$  provided by experiments or RANS CFD, and the velocity fluctuations  $u'_1(r, m, \omega)$  are modelled as linear instability waves of frequency  $\omega$  and azimuthal mode  $m$ , using LST on the mean velocity profile as a parallel base-flow. The axial wavenumber  $k_h$  is also determined using linear stability results. The source is a convected wave enclosed in a Gaussian envelope.  $y_1$  is the axial coordinate and the position of the wavepacket peak amplitude  $y_{1c}$  is hypothesized from physical knowledge. The amplitude of  $u'_1$  and the length scale  $L$  are deduced from measurements of the sound field of the free jet, e.g. *from the outside*, following the method proposed by Cavalieri *et al.* [38]. Calculation of the radiated sound using Lighthill's acoustic analogy without surface effects led to close agreement between model and experiment for low polar angles.

### **Model with PSE data**

PSE is now used to provide the velocity fluctuations in an attempt to overcome the high degree of empiricism and hypotheses on source location of the LST approach. Equation 5 illustrates the implementation of a PSE-based source model for  $T_{11}$  for given mode and frequency.

$$S_D = T_{11}(y_1, r, \phi, m, \omega) = 2\rho_0 \bar{U}_1(y_1, r) u'_1(y_1, r) e^{im\phi}, \quad (5)$$

where  $u'_i(y_1, r) = \hat{u}_i(y_1, r) e^{i \int^{y_1} \alpha(\xi) d\xi}$ , product of the slow function in PSE responsible for the amplitude and the rapidly varying part. Note that the kinematic model presented in Equation 4 may also apply here. In that case, the values of parameters  $y_{1c}$ ,  $k_h$  and  $L$  are deduced from PSE data and the model is used as a proxy to make PSE solutions radiate.

The PSE provides the velocity fluctuations  $u'_i$  with arbitrary amplitude. The amplitude parameter may be obtained either *from the inside* with a hydrodynamic calibration, or *from the outside* using a noise measurement. The PSE-based one-point model is unable to provide absolute levels with hydrodynamic calibration as source de-synchronisation is missing. The exception may be possibly at small  $L/D$  around two to three, as suggested in [53], when the non-linear effects on instabilities are still negligible.

## **4.2 Propagation modelling**

The analysis from wind-tunnel test results shows that we are mostly interested in frequencies such that the ratio  $C/\lambda_a \in [0.5, 5]$ , with  $C$  the wing chord. At moderate subsonic jet Mach numbers, we may consider that the hydrodynamic wavelength  $\lambda_h \simeq \lambda_a/2$ . Lift fluctuation noise will occur if  $\lambda_h > C$ , implying that  $C/\lambda_a < 1/2$ . Since this value is the lower bound of our interest range, we can expect that the main driver for jet-flap interaction noise will be diffraction at the trailing edge. For this purpose, several studies such as Nogueira *et al.* [52], Piantanida *et al.* [1] and daSilva *et al.* [56] have shown that tailored Green's functions (TGF) for the semi-infinite plane can be used to predict the scattered sound field.

Two TGFs have been implemented. The first is the function proposed by Ffowcs-Williams and Hall [57] for a semi-infinite flat plate. This tailored Green's function includes a far-field assumption: observers are located at distances from the edge of many wavelengths. This translates into conditions on  $kr$  and  $r/r_0$ :  $kr \gg 1$  and  $r \gg r_0$ . This function was adapted to a case with swept trailing edge and used in Piantanida *et al.* [1] to study the impact of swept plates. The second is the exact TGF for a semi-infinite flat plate with an ambient flow capability of Roger *et al.* [58], for which the first and second gradients of the Green's function with respect to the source coordinates are calculated in Cartesian coordinates.

The applied-mathematics team of Airbus Group has developed the ACTIPOLE software [59, 60] destined to solve various acoustic propagation problems using integral equations and Boundary-Element Methods (BEM). The main advantages of integral equations and BEM solvers are accuracy and surface meshing. The ACTIPOLE solver includes a fast multipole iterative method to accelerate the resolution. The method will address the diffraction of a perturbation – the convecting wavepacket – by the object. Physically, the BEM mesh represents the finite-chord realistic shape of either plate or wing. This fine representation bears its importance as finite airfoil chord is known to have significant effects on low-frequency trailing-edge noise, see Moreau and Roger [61].

The coupling between the wavepacket models and the three propagators : either tailored Green's functions and ACTIPOLE, was validated by cross comparing the results between each other, to experimental data as well as to earlier BEM results in Piantanida *et al.* [1].

As noted in [1], the analytical TGFs provide a first-order estimate of the jet-plate interaction noise, while the BEM delivers higher precision as it captures secondary lobes and more accurate sound extinctions that are due to other edges and corners. Our industrial modelling objective being to capture the jet wavepacket diffraction by any wing and flap shape, the BEM is selected in the applications in 5.

### ***Assumptions***

The main assumptions of the overall model are:

- The jet flow is axisymmetric and unaffected by installation. This hypothesis comes from the stability analysis method used, and we are able to verify its validity through RANS CFD analysis. The assumption appears however strong for many realistic cases: the pylon and the aircraft wing are both likely to distort the jet into more 3D topologies.
- The ambient flow in which the sound propagates is uniform. This is associated to the TGFs and to the BEM, and is acceptable as long as the flow gradients around realistic configurations are not large.
- Jet blockage and refraction in jet shear layers are negligible. This also comes from the propagation methods and translates into sound wavelengths being

an order of magnitude larger than jet diameter, i.e.  $St < 1/M_{a,j}$ . Such flow-acoustic interaction might occur at low polar angles, where the propagation path of the scattered noise through the jet flow could be of the order of several acoustic wavelengths. This limitation could be overcome by coupling BEM with a finite element method capturing detailed propagation effects through the jet flow.

- The sound diffraction at the jet nozzle is negligible. Indeed, the engine nozzle is not included in our BEM simulations. This assumption seems acceptable given that we study low Strouhal numbers.

## 5 Evaluation of model results versus experiments

This section presents the comparison of modelling results against experimental data described in Section 3.

### 5.1 Academic jet-plate cases

The wavepacket model predictions are evaluated against the academic jet-plate configurations. Two source models are applied to a large rectangular plate. In a second step, a more realistic plate design is reproduced by simulation.

#### 5.1.1 Application to the rectangular plate

We first compare results of the LST-based model and of the PSE-based model coupled with BEM on the jet diffraction by a rectangular plate as tested in [1]. Figure 12 presents results obtained with both models at  $St = 0.2$ . The choice of  $St = 0.2$  is not optimal as we know that PSE performs better at  $St \geq 0.3$  [44]. The Lighthill tensor component  $T_{11}$  is modelled with a kinematic source model following Equation 4. Both models share the same procedure for source amplitude calibration: the amplitude is based on isolated jet measurements in the downstream direction where the axisymmetric mode dominates the sound field. With this calibration on amplitude, the LST-based model recovers the scattered field within 2 dB of the measurements. This is not true for the PSE-based model: the level of empiricism is lower, the parameters are not tuned yet its coherence is still perfect. In turn its free-field efficiency is not realistic. Consequently the scattered field is over-estimated.

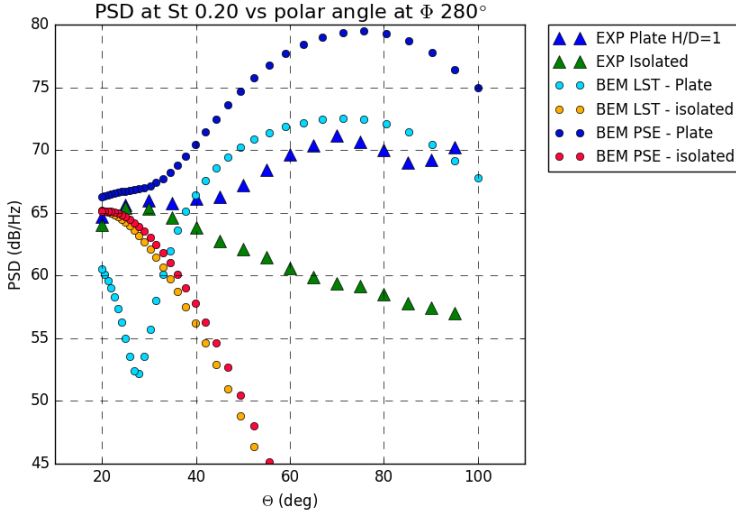

**Fig. 12** Noise predictions obtained with LST-based and PSE-based kinematic source models and ACTIPOLE. Experimental data is presented with triangles. Simulation data is shown with dots. The noise source models are calibrated on isolated measurements at  $\theta = 20^\circ$ .  $M_j = 0.6$ ,  $St = 0.2$ ,  $m = 0$ .

The model with LST and noise education is successful at obtaining absolute noise levels and a realistic directivity in the polar direction. This could be expected from [6] and is remarkable considering the large degree of simplification contained in the source model. The education of source parameters from free-jet noise allows capturing both direct and scattered sound fields. This confirms that the educated parameters adequately compensate the lack of coherence decay in the model. Note that the match between isolated jet predictions and measurements improves when the azimuthal mode  $m = 0$  is extracted from the measured sound field.

The model based on PSE is less empirical than the LST model and becomes further independent from experiments. The prediction of the polar field shape of installation noise is also satisfactory, however only relative noise levels can be expected from the model. We retain the *PSE-based wavepacket + BEM* prediction scheme to study the impact of plate design.

### 5.1.2 Application to different plate designs

Piantanida *et al.* [1] reported on the significant impact of a swept trailing edge and showed how the other plate edges create additional lobes in the noise field due to secondary diffraction. This experience led us to design, test and simulate a plate with a realistic wing plan form. Figure 13 shows two plates tested at the Bruit et Vent jet laboratory of the PPRIME Institute. The geometries of the rectangular plate and the Wing Plan Form (WPF) plate

display a large difference in chord ( $L/D = 4$  versus 2.67) and in edge sweep angles ( $0^\circ$  versus  $0^\circ$  inboard and  $18^\circ$  outboard).

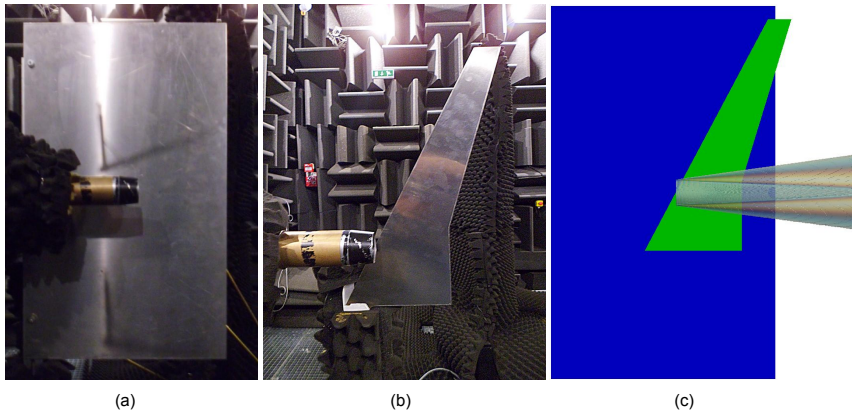

**Fig. 13** (a) Rectangular flap plate, (b) Wing Plan Form plate tested at Bruit et Vent, PPRIME, and (c) Comparison of the rectangular plate shape (blue) with the WPF plate (green). Pictures are Airbus and PPRIME copyright.

A kinematic wavepacket model was computed based on 2D PSE analysis on the RANS baseflow for the PPRIME single-stream nozzle at  $M_j = 0.6$  in static conditions. The BEM solver computed the diffraction of the source on observers at the experimental azimuthal array. Figure 14 presents measured and simulated noise on the two plates, rectangular and WPF.

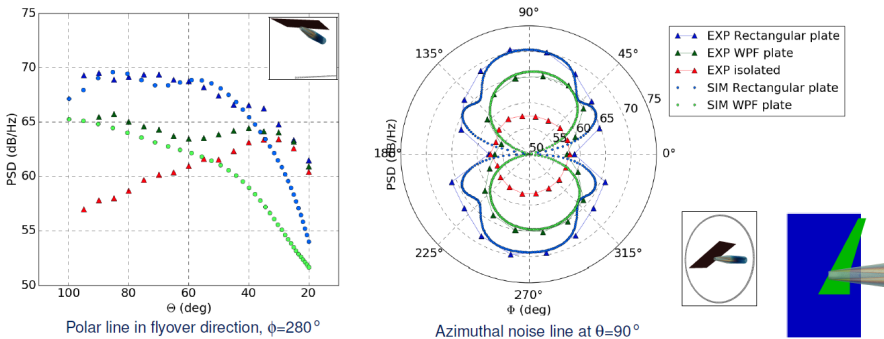

**Fig. 14** Noise directivity measured and simulated on two plates: rectangular plate and baseline WPF plate. The source is calibrated on the rectangular plate installed noise peak level.  $M_j = 0.6$ ,  $St = 0.4$ ,  $H/D = 1$ .

We first focus on experimental results. An analysis of the microphone noise spectra shows that the effect of WPF plate is visible in the range  $St \in [0.1, 1]$ , and the magnitude of the effect is maximum at the lower frequency end.

Azimuthal and polar directivity indicate marked secondary lobes for the rectangular plate and a single lobe for the WPF plate. As the ratio  $C/\lambda$  is lower for the WPF plate, less secondary lobes are generated. The WPF plate also shifts the peak energy to the inboard sideline. The significant 5 dB noise reduction by the realistic WPF against the rectangular plate is believed to originate from two features. The first feature is the shorter chord: Low-frequency instabilities are in their growth phase as they convect past both plates trailing edges and do not reach its maximum until some diameters downstream, e.g.  $X/D = 6$  for  $St = 0.4$ . In a radially-integrated view, source amplitudes are expected to be lower at  $X/D = 2.66$  than at  $X/D = 4$ . The second factor is the partially-swept trailing edge that appears able to both reduce noise levels and redirect the diffraction lobes to the sideline.

The wavepacket-BEM model is able to predict important plate-design features such as noise reduction and directivity. Figure 14 illustrates that the simplified model predicts an accurate noise reduction of 5 dB and a correct polar directivity shape in the range of angles where JSI is dominant over free jet noise, i.e. at  $\theta > 60^\circ$ . The azimuthal directivity shift to  $\phi \simeq 310^\circ$  is also well reproduced, and the swept lobe amplitude is captured.

The wavepacket-BEM model is successful at capturing the plate design effect. This achievement enables us to move forward to realistic wing configurations.

## 5.2 Realistic jet-wing cases

This section is dedicated to the application of the wavepacket-BEM model to realistic geometries tested in large-scale anechoic wind-tunnel. After a selection of the test cases and the wavepacket model, we mean to identify how the wavepacket-BEM model captures (1) the near field pressure on the under side of the wing, and (2) a variation of the vertical separation on the acoustic far field.

### 5.2.1 Selection of the case and the prediction model

Test points are selected from the JERONIMO and AMBROSIA test campaigns with axisymmetric nozzles, at matched-jets  $M_j = 0.6$  condition, with the REX80 wing model translated over a range of  $H/D_m$ .

The Lighthill's tensor  $T_{11}$  is modelled as a kinematic wavepacket using the PSE solution on a single-stream base flow. The  $m = 0$  axisymmetric mode is considered, and the model is coupled to ACTIPOLE. The Airbus REX80 wing model is meshed for the BEM solver for frequencies up to  $St = 3$ .

The wavepacket-BEM prediction model is evaluated against a relevant range of  $H/D_m \in [0.8, 1.1]$ , for which the jet does not impinge on the flap. Over this range of  $H/D_m$  and given the absence of nozzle pylon, the uninstalled jet mean flow hypothesis is close to be satisfied. The domination of



JFI noise versus direct jet noise is verified at  $H/D_m = 1$  up to  $St = 1$  in the forward arc as shown in Figs. 7 and 8.

Simulations have been performed in the Strouhal-number range  $St \in [0.2, 1]$  in which JFI noise dominates. The present analysis focuses on  $M_j = 0.6$  in static conditions, at two frequencies  $St = 0.4$  and  $St = 0.8$ . At  $St = 0.8$ , chord and acoustic wavelength are comparable, the ratio  $C/\lambda_a = 1.2$ , while the chord is larger than the flow scale,  $C/\lambda_h = 3.1$ .

Figure 15 illustrates the wavepacket diffraction on REX80 wing model at the radial position  $H/D_m = 0.8$ . Wavefronts in the parallel XZ plane show how the wing is within the hydrodynamic reach, the separation of hydrodynamic and acoustic scales, as well as the upstream propagating wave on the wing suction side. Data in the normal section YZ plane displays the expected extinctions in the spanwise direction, and how the swept trailing edge scatters energy preferentially at a lateral direction toward the wing tip.

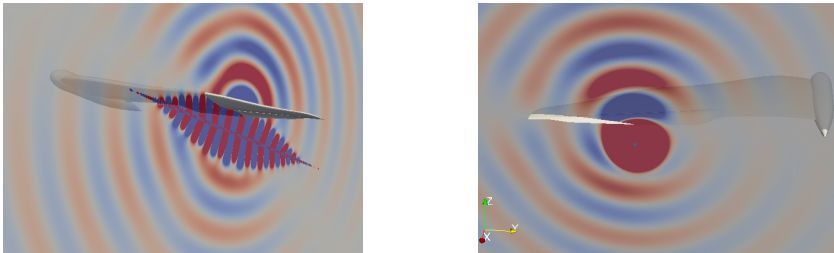
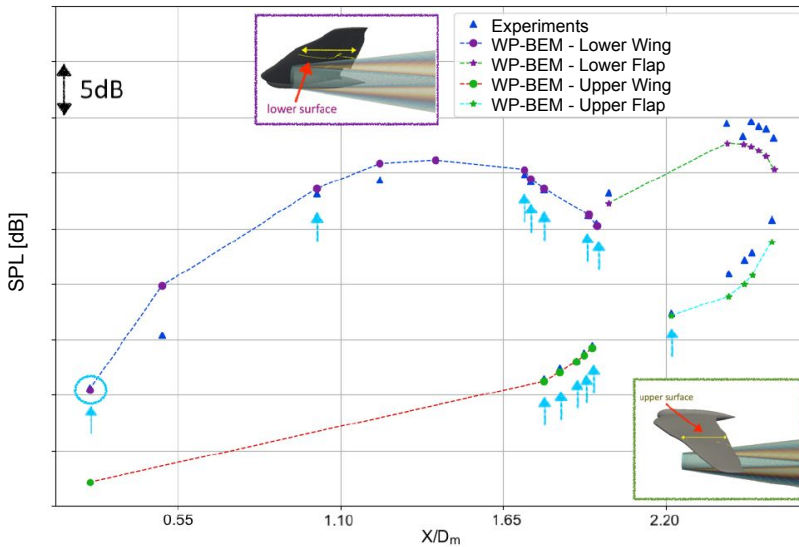

**Fig. 15** Real part of pressure on (left) a parallel plane and (right) a normal plane at the flap trailing edge location, computed by ACTIPOLE for REX80 at position  $H/D_m = 0.8$ . Kinematic line source wavepacket model,  $M_j = 0.6$  in static conditions,  $St = 0.8$ .

### 5.2.2 Unsteady surface pressure

Wall-pressure measurements on sensors located streamwise on the wing model are now reproduced by simulation and results are compared in Figure 16. Simulated data sets are differentiated between the main wing and the flap, as well as between upper and lower sides. Predictions use a line kinematic wavepacket for the axisymmetric mode of  $T_{11}$  and ACTIPOLE at  $St = 0.8$ , and was calibrated on data measured by the most upstream Kulite sensor located at  $X/D_m = 0.2$  and  $Y/D_m = 0$ , on the lower side, on the jet axis and near the wing leading edge. This calibration can be seen as a kind of initial condition, from which we evaluate if the model can capture the downstream evolution. Firstly, measurements show that a significant dynamic of 5 to 15 dB separates lower and upper Kulites with higher levels on the lower side. The lower side faces the jet flow which imposes intense hydrodynamic and acoustic fluctuations in its irrotational near field - there surface pressure sensors measure both incident and scattered fields while the upper side measures mainly the scattered field. The shielding of jet hydrodynamic pressure field by the airframe explains the strong level reduction from lower side to upper side. On the lower

side, PSD levels increase about exponentially from a position  $X/D_m = 0.2$  close to leading edge to  $X/D_m = 2.6$  near the trailing edge - a characteristic of jet wavepackets. A 20 dB dynamic was measured between upstream and downstream sensors. Surface curvature is thought to be responsible for the convex shape of the PSD on the wing  $X/D_m \in [0.2, 1.8]$ .



**Fig. 16** Sound pressure levels measured and predicted on model-mounted Kulite sensors. Upper and lower side sensors are shown.  $M_j = 0.6$  in static conditions,  $St = 0.8$ , JERONIMO CEPRA19 test.

The  $T_{11} m = 0$  wavepacket-BEM model reproduces well the measured axial PSD evolution on both lower and upper sides of the wing by an order of 1 dB, and on the flap, the gap increases to 2 dB. Because the match is close, each blue arrow indicates when an experimental data point lies below the simulation data. Unfortunately the sensor located on the upper side near the leading edge ( $X/D_m = 0.2$ ) malfunctioned in the test and we could not measure the pressure decay all the way to leading edge. Whereas the source is calibrated against a single point on the wing lower side, the wavepacket-BEM model is able to predict the diffracted field grazing on the surface from the flap trailing edge to the top of main wing at  $X/D_m \simeq 1.8$ . These results show in particular how the jet wavepacket axisymmetric mode dominates the incident pressure field, and how the BEM predicts an accurate diffraction on the upper wing surface. We now turn our attention to the acoustic field.

### 5.2.3 Acoustic directivity and radial proximity impact

Three test points are selected from the AMBROSIA CEPRA19 test database to cover the range  $H/D_m \in [0.8, 1.1]$ . The corresponding free-field noise spectra are displayed in Figure 7. The analysis now focuses on two frequencies of interest  $St = 0.4$  and  $St = 0.8$ . Figure 17 summarises the results obtained with the  $T_{11} m = 0$  wavepacket-BEM model on a flyover polar arc corresponding to CEPRA19 microphones. For each frequency, a single source is used for all installed cases and its amplitude is calibrated on a single test point and a single microphone: the intermediate configuration corresponding to  $H/D_m = 0.94$ , and the microphone normal to the nozzle in the flyover direction  $[\theta, \phi] = [90, 270]^\circ$ . The free-jet measurements and the isolated wavepacket radiation are also presented, however our analysis will focus on the installed wing cases.

At  $St = 0.4$  the agreement between experiments and simulation is remarkable: the wavepacket-BEM model predicts the forward directivity of jet-flap interaction noise over almost the entire range of polar angles. The largest disagreement is observed at the most upstream angles ( $\theta \sim 135^\circ$ ) in flyover where sound levels are overestimated by 3 to 4 dB, and where free-field measurements are increasingly difficult to perform.

The wavepacket-BEM model is applied to the same configurations at a higher frequency  $St = 0.8$  and calibrated in the same manner as for  $St = 0.4$ . We bear in mind that at this frequency, jet-flap interaction dominates largely over direct jet noise only for  $H/D_m < 1$  and the configuration with the largest radial distance does not exhibit dominant jet-flap interaction noise levels. Figure 17 shows that the model predictions appear globally physical over the range of installed configurations. The model reproduces the measured polar directivity in the flyover direction, within 2 to 3 dB and display a dual-lobe directivity expected at the  $C/\lambda_a = 1.2$  ratio. The dual-lobe feature is present in the experimental data but in a much more subtle manner at flyover than in the simulation.

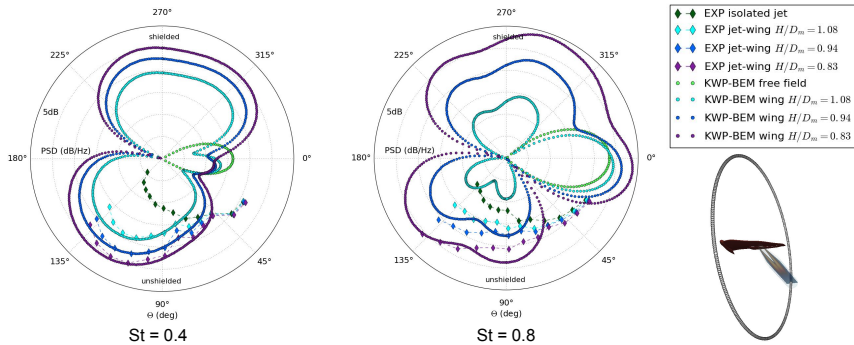

**Fig. 17** Noise directivity measured in the AMBROSIA CEPRA19 test and simulated on REX80 wing model. The wavepacket source intensity level is calibrated on the measured noise levels at  $[\theta, \phi] = [90^\circ, 270^\circ]$  in the flyover direction.  $M_j = 0.6$  in static conditions, and varying  $H/D_m$ . AMBROSIA CEPRA19 test campaign. (left)  $St = 0.4$  and (right)  $St = 0.8$ .

## 6 Conclusion

We combined an analysis of experimental data and simplified noise source and propagation modelling to improve the understanding and the prediction of broadband jet-flap interaction noise.

Jet-flap interaction is characterized over a wide range of test scales: laboratory canonical configurations, realistic large-scale wind tunnel, and full-scale aircraft in flight. Broadband JFI tends to dominate jet noise at low Strouhal-number range  $[0.3, 1.5]$  and at forward polar angles  $\theta \geq 90^\circ$ . On top of the broadband spectrum, narrow-band peaks are believed to be signatures of tonal-jet flap interaction [62].

Coherent, advecting and exponentially-growing surface pressure signatures are discovered not only at reduced model scale but also on an aircraft wing in flight. One-fiftieth laboratory jets, one-tenth scale wind-tunnel jets and full-scale engine jets generate similar signatures in the near field: axially-organized structures impose significant pressure fluctuations on the wing. The data analysis confirms the choice of wavepacket models to describe this observed behaviour, and substantiates the hypothesis that the flap edge discontinuity radiates sound due to diffraction of organized structures.

A methodology is developed to predict jet-flap interaction noise based on wavepacket source models, and includes base flow estimation with RANS CFD, stability analysis, noise source and propagation modelling. Linear stability tools are used, comforted by the fact that tested wing chords are shorter than the jet potential core. Beyond the potential core end, modelling with linear-stability tools becomes more complex due to the non-modal nature of wavepacket dynamics. While the empirical wavepacket based on LST and noise education is found to be relevant to study the phenomenon, non-local one-dimensional PSE is selected for its robustness and its account of a slowly varying jet. A key assumption is the mean flow axisymmetry, in extenso the

sources are unaffected by installation. The noise source models use the information from stability analysis: A kinematic one-point model is used as a proxy to make PSE results radiate sound. The PSE directly provides values for all parameters except for the amplitude that remains to be calibrated using acoustic data on a single installed measurement. The source model is chained to propagators able to capture the wavepacket diffraction by surfaces. The analytical tailored Green's function provides a first-order estimate of the scattered sound field, while the BEM delivers results at higher precision.

Physical effects are studied with the low-order modelling strategy: airframe design and engine positioning under wing. First, a flat plate with realistic wing plan form and a short chord was tested, combining the two physical effects of trailing-edge sweep and of chord length on wavepacket diffraction. The wavepacket-BEM model is able to predict the reduced and relocated diffraction lobes due to the plate design. Then, the wavepacket-BEM model is applied to realistic exhaust-airframe configurations. Unsteady surface pressure fluctuations are examined on a realistic wing and flap at  $H/D_m = 0.8$ . Simulation results compared to surface sensors measurements show that the  $T_{11}$ ,  $m = 0$  kinematic wavepacket model coupled to ACTIPOLE predicts a correct pressure amplification rate from wing leading edge to flap trailing edge and accurate diffraction on the upper surface. The acoustic directivity of JFI matches well at low frequencies  $St = 0.4$  but could be improved at  $St = 0.8$ . The JFI noise amplification measured with decreasing  $H/D_m$  from 1.1 to 0.8 is captured with higher accuracy at  $St = 0.4$  than at  $St = 0.8$ . Future investigations should explain the remaining discrepancies at higher frequency, and study the azimuthal directivity.

Although the degree of simplification of the turbulent jet as a noise source is considerable, the model could reproduce jet-flap interaction trends measured on canonical jet-plate cases as well as on realistic geometries. Consistently with previous work at academic level [1, 6, 56, 63], the axisymmetric mode is identified on both academic and realistic test cases as the dominant component of the jet hydrodynamic near-field pressure, and the most efficient source of JFI noise. Our results corroborate the choice of  $T_{11}$  to obtain jet installation noise characteristics at the first order.

Our results support the contention that the coherent structures generated by the Kelvin-Helmholtz instability of the turbulent mean field are the main sources of jet-airframe interaction noise through a diffraction process, this not only in the jet laboratory but also in large-scale wind tunnel and for a full-scale aircraft with 30-million Reynolds-number engine jet flows.

Modern engine installation creates complex flows, both the engine pylon and the high-lifting wing are likely to distort the jet. To investigate 3D installed jets, the modelling strategy should be upgraded with two-dimensional PSE [64]. Another direction is the Resolvent analysis which has the capability to

remove some empiricism on the predicted wavepacket amplitude and coherence. The resolvent framework should then be combined with a model for the forcing that correctly reproduces the sound-producing wavepackets [65].

**Acknowledgments.** This research was supported by Airbus. The French government supported the national research projects EXEJET and AMBROSIA through DGAC contracts. Some wind-tunnel test data is presented from the European 7<sup>th</sup> Framework Project JERONIMO, contract number ACP2-GA-2012-314692. J.H. would like to thank Isabelle Boulet and the Airbus Test team for the conduct of the flight tests, Frédéric David, the ONERA CEPRA19 team and Renaud Davy for the conduct of wind-tunnel tests, Selene Piantanida and Vincent Jaunet for the conduct of the lab tests, Igor Maia and André Cavalieri for fruitful discussions on wavepacket modelling, and Jean-Paul Roméo for his support on BEM simulations.

## Declarations

- Funding. Airbus funded this research.
- Competing interests. The authors report no competing interests that might be perceived to influence the results and/or discussion reported in this paper.
- Authors' contributions. J.H. performed the modelling, the stability and aeroacoustic simulations and the data analysis. G.P. performed the RANS CFD and provided support on data processing. P.J. provided the PSE solver. M.R. provided the tailored Green's function with flow. J.H., P.J. and M.R. discussed the data interpretation. J.H. wrote the manuscript. All the authors read and approved the final version of the manuscript.
- Ethics approval. Not applicable.
- Informed consent. Not applicable.

## References

- [1] Piantanida, S., Jaunet, V., Huber, J., Wolf, W.R., Jordan, P., Cavalieri, A.V.G.: Scattering of turbulent-jet wavepackets by a swept trailing edge. *Journal of Acoustical Society of America* **140**(6), 4350 (2016). <https://doi.org/10.1121/1.4971425>
- [2] Lawrence, J.L.T., Azarpeyvand, M., Self, R.H.: Interaction between a flat plate and a circular subsonic jet. In: 17th AIAA/CEAS Aeroacoustics Conference and Exhibit, Portland, OR, USA (2011)
- [3] Low, J.K.C.: Effects of forward motion on jet and core noise. In: AIAA 4th Aeroacoustics Conference, Atlanta, Georgia, USA (1977)
- [4] SenGupta, G.: Analysis of jet-airframe interaction noise. In: 8th Aeroacoustics Conference (1983)

- [5] Head, R.W., Fisher, M.J.: Jet/surface interaction noise: analysis of far-field low-frequency augmentation of jet noise due to the presence of a solid shield. (1976)
- [6] Cavalieri, A.V.G., Jordan, P., Wolf, W., Gervais, Y.: Scattering of wavepackets by a flat plate in the vicinity of a turbulent jet. *Journal of Sound and Vibration* (2014)
- [7] Bushell, K.W.: Measurement and prediction of jet noise in flight. In: AIAA 2nd Aeroacoustics Conference, Hampton, VA, USA (1975)
- [8] Reddy, N.N., Tanna, H.K.: Installation effects on jet noise in flight. In: 6th Aeroacoustics Conference (1980). <https://doi.org/10.2514/6.1980-1044>. <https://arc.aiaa.org/doi/abs/10.2514/6.1980-1044>
- [9] Southern, I.S.: Exhaust noise in flight: the role of acoustic installation effects. In: 6th AIAA Aeroacoustics Conference (1980)
- [10] Way, D.J., Turner, B.A.: Model tests demonstrating under-wing installations effects on engine exhaust noise. In: 6th AIAA Aeroacoustics Conference (1980)
- [11] Wang, M.: Wing effect on jet noise propagation. In: 6th AIAA Aeroacoustics Conference (1980)
- [12] Miller, W.R.: Flight effects for jet-airframe interaction noise. In: 8th AIAA Aeroacoustics Conference. AIAA-1983-0784, Atlanta, Georgia, USA (1983)
- [13] Lawrence, J.L.T.: Aeroacoustic interactions of installed subsonic round jets. PhD thesis, University of Southampton, Institute of Sound and Vibration Research (July 2014)
- [14] Shearin, J.G.: Investigation of jet-installation noise sources under static conditions. NASA-TP-2181, NASA, Langley Research Center; Hampton, VA, United States (August 1983)
- [15] Brown, W.H., Ahuja, K.K.: Jet and wing/flap interaction noise. In: 9th AIAA/CEAS Aeroacoustics Conference (1984)
- [16] Shivashankara, B.N., Blackner, A.M.: Installed jet noise. In: 3rd AIAA/CEAS Aeroacoustics Conference (1997)
- [17] Boeing: Low-speed Aeroacoustic Facility. [http://www.boeing.com/commercial/techsvcs/boeingtech/bts\\_acoub.html](http://www.boeing.com/commercial/techsvcs/boeingtech/bts_acoub.html)
- [18] Viswanathan, K.: Best practices for accurate measurement of pure jet noise. *International Journal of Aeroacoustics* **9**(1 and 2), 145–206 (2010)

- [19] Elkoby, R.: Full-scale propulsion airframe aeroacoustics investigation. In: 11th AIAA/CEAS Aeroacoustics Conference, Monterey CA, USA (2005)
- [20] Mengle, V.G., Elkoby, R., Brusniak, L., Thomas, R.H.: Reducing propulsion airframe aeroacoustic interactions with uniquely tailored chevrons: 2. installed nozzles. In: 12th AIAA/CEAS Aeroacoustics Conference, Cambridge MA (2006)
- [21] Mengle, V.G., Elkoby, R., Brusniak, L., Thomas, R.: Reducing propulsion airframe aeroacoustic interactions with uniquely tailored chevrons: 3. jet-flap interaction. In: 12th AIAA/CEAS Aeroacoustics Conference, Cambridge MA (2006)
- [22] Mengle, V.G., Stoker, R.W., Brusniak, L., and R. H. Thomas, R.E.: Flap-eron modification effect on jet-flap interaction noise reduction for chevron nozzles. In: 13th AIAA/CEAS Aeroacoustics Conference, Roma, Italy (2007)
- [23] Mengle, V.G.: The effect of nozzle-to-wing gully height on jet flow attachment to the wing and jet-flap interaction noise. In: 17th AIAA/CEAS Aeroacoustics Conference, Portland, OR, USA (2011)
- [24] Piccin, O.: CEPRA19: the ONERA large anechoic facility. In: 15th AIAA/CEAS Aeroacoustics Conference, Miami FL (2009)
- [25] Davy, R., Brossard, C., Jourdan, J.-M., Pioche, Y., Piccin, O.: Installation effects characterization of VHBR engines: 2. experimental study using particle image velocimetry. In: 15th AIAA/CEAS Aeroacoustics Conference, Miami FL (2009)
- [26] Dezitter, F., Bezdard, H., de Saint Victor, X., Zeggai, K., Britchford, K., Joubert, G., Puigt, G.: Installation effects characterization of VHBR engines: 3. CFD assessment for jet mixing. In: 15th AIAA/CEAS Aeroacoustics Conference, Miami FL (2009)
- [27] Huber, J., Omais, M., Vuillemin, A., Davy, R.: Characterization of installation effects for HBPR engine part IV: Assessment of jet acoustics. In: 15th AIAA/CEAS Aeroacoustics Conference, Miami FL, USA (2009)
- [28] Huber, J., Drochon, G., Pintado-Peno, A., Cléro, F., Bodard, G.: Large-scale jet noise testing, reduction and methods validation EXEJET: 1. project overview and focus on installation. In: 20th AIAA/CEAS Aeroacoustics Conference, Atlanta GA, USA (2014)
- [29] David, F., Jourdan, J.-M., Cléro, F., Koenig, M., Huber, J.: Large-scale jet noise testing, reduction and methods validation EXEJET: 4. flows characterization with PIV in the CEPRA19 anechoic wind tunnel of



- ONERA. In: 20th AIAA/CEAS Aeroacoustics Conference, Atlanta GA, USA (2014)
- [30] Fleury, V., Davy, R.: Large-scale jet noise testing, reduction and methods validation EXEJET: 5. analysis of jet-airfoil interaction noise by microphone array techniques. In: 20th AIAA/CEAS Aeroacoustics Conference, Atlanta GA, USA (2014)
- [31] Meloni, S., Mancinelli, M., Camussi, R., Huber, J.: Wall pressure fluctuations induced by a compressible jet in installed configuration. *AIAA Journal* **58**(7), 2991–3000 (2020)
- [32] Rolls-Royce Ltd.: Trent XWB. <https://www.rolls-royce.com/products-and-services/civil-aerospace/airlines/trent-xwb.aspx#section-overview>
- [33] Blandeau, V., Regnier, V., Bousquet, P.: Acoustic behaviour of ground plates for aircraft noise flight tests. In: 24th AIAA/CEAS Aeroacoustics Conference, pp. 2018–3295 (2018)
- [34] Blandeau, V.P., Bousquet, P.: A new plate design to improve the accuracy of aircraft exterior noise measurements on the ground. In: *AIAA AVIATION 2021 FORUM*, pp. 2021–2158 (2021)
- [35] Viswanathan, K.: Does a model-scale nozzle emit the same jet noise as a jet engine? **46**(2), 336–355 <https://arxiv.org/abs/https://doi.org/10.2514/1.18019>. <https://doi.org/10.2514/1.18019>
- [36] Léon, O., Brazier, J.-P.: Investigation of the near and far pressure fields of dual-stream jets using an Euler-based PSE model. In: 19th AIAA/CEAS Aeroacoustics Conference (2013). <https://doi.org/10.2514/6.2013-2280>
- [37] Piantanida, S.: Time and frequency domain modelling of turbulent-jet wavepackets for free and installed jet noise. PhD thesis, Université de Poitiers (May 2017)
- [38] Cavalieri, A.V.G., Jordan, P., Colonius, T., Gervais, Y.: Axisymmetric superdirectivity in subsonic jets. *Journal of Fluid Mechanics* **704**, 388 (2012)
- [39] Breakey, D.E.S., Jordan, P., Cavalieri, A.V.G., Léon, O., Zhang, M., Lehnasch, G., Colonius, T., Rodríguez, D.: Near-field wavepackets and the far-field sound of a subsonic jet. In: 19th AIAA / CEAS Aeroacoustics Conference and Exhibit, Berlin, Germany (2013)
- [40] Cavalieri, A., Jordan, P., Gervais, Y., *et al.*: Scattering of wavepackets by a flat plate in the vicinity of a turbulent jet. In: 18th AIAA/CEAS

Aeroacoustics Conference, Colorado Springs, CO, USA (2012)

- [41] Mead, C.J., Strange, P.J.R.: Under-wing installation effects on jet noise at sideline. In: 4th AIAA/CEAS Aeroacoustics Conference (1998)
- [42] Faranosov, G.A., Belyaev, I.V., Kopiev, V.F., Zaytsev, M.Y., Aleksentsev, A.A., Bersenev, Y.V., Chursin, V.A., Viskova, T.A.: Adaptation of the azimuthal decomposition technique to jet noise measurements in full-scale tests. *AIAA Journal* **55**(2), 572–584 (2017) <https://arxiv.org/abs/https://doi.org/10.2514/1.J055001>. <https://doi.org/10.2514/1.J055001>
- [43] Aujogue, N., Huber, J., Julliard, E., Antoni, J., Leclère, Q.: Experimental investigation of the supersonic jet noise from aircraft engines using acoustic imaging. In: 28th AIAA/CEAS Aeroacoustics 2022 Conference. <https://doi.org/10.2514/6.2022-2867>. <https://arc.aiaa.org/doi/abs/10.2514/6.2022-2867>
- [44] Breakey, D.E.S., Jordan, P., Cavalieri, A.V.G., Nogueira, P.A.S., Léon, O., Colonius, T., Rodríguez, D.: Experimental study of turbulent-jet wave packets and their acoustic efficiency. *Physical Review Fluids* **2**(124601) (2017)
- [45] Tinney, C.E., Jordan, P.: The near pressure field of co-axial subsonic jets. *Journal of Fluid Mechanics* **611**, 175–204 (2008)
- [46] Huerre, P., Monkewitz, P.: Absolute and convective instabilities in free shear layers. *Journal of Fluid Mechanics* **159**, 151–168 (1985)
- [47] Pont, G., Brenner, P.: High order finite volume scheme and conservative grid overlapping technique for complex industrial applications. In: International Conference on Finite Volumes for Complex Applications, pp. 295–303 (2017). [https://doi.org/10.1007/978-3-319-57394-6\\_32](https://doi.org/10.1007/978-3-319-57394-6_32)
- [48] Jordan, P., Colonius, T., Brès, G., Zhang, M., Towne, A., Lele, S.K.: Modeling intermittent wavepackets and their radiated sound in a turbulent jet. In: Proceedings of the CTR Summer Program 2014, Stanford, CA, USA (2014)
- [49] Cavalieri, A.V.G., Jordan, P., Agarwal, A., Gervais, Y.: Jittering wavepacket models for subsonic jet noise. *Journal of Sound and Vibration* **330**(18), 4474–4492 (2011)
- [50] Cavalieri, A.V.G., Agarwal, A.: Coherence decay and its impact on sound radiation by wavepackets. *Journal of Fluid Mechanics* **748**, 399–415 (2014)
- [51] Cavalieri, A.V.G., Jordan, P., Lesshafft, L.: Wave-packet models for jet

- dynamics and sound radiation. *Applied Mechanics Review* **71**(020802) (2019)
- [52] Nogueira, P.A.S., Piantanida, S., Cavalieri, A.V.G., Jordan, P.: PSE-based prediction of sound radiation by installed jets. In: 22nd AIAA/CEAS Aeroacoustics Conference, Lyon, France (2016)
- [53] Faranosov, G., Bychkov, O.P., Kopiev, V., Soares, L.F., Cavalieri, A.V.: The Modeling of Jet-Plate Interaction Noise in the Presence of Co-Flow. In: 25th AIAA/CEAS Aeroacoustics Conference, Delft, The Netherlands (2019). <https://doi.org/10.2514/6.2019-2492>
- [54] Guðmundsson, K.: Instability wave models of turbulent jets from round and serrated nozzles. Phd thesis, California Institute of Technology (2010)
- [55] Sasaki, K.: Estudo de controle de pacotes de onda em jatos utilizando as equações de estabilidade parabolizadas. Master's thesis, Instituto Tecnológico de Aeronáutica, Sao Jose Dos Campos, SP - Brazil (2014)
- [56] da Silva, F.D., Jordan, P., Cavalieri, A.V.G.: On the modeling of wavepacket scattering noise with coherence effects. *Journal of Acoustical Society of America* **146**(6) (2019)
- [57] Williams, J.E.F., Hall, L.H.: Aerodynamic sound generation by turbulent flow in the vicinity of a scattering half plane. *Journal of Fluid Mechanics* **40**(4), 657–670 (1970)
- [58] Roger, M., Moreau, S., Kucukcoskun, K.: On sound scattering by rigid edges and wedges in a flow, with applications to high-lift device aeroacoustics. *Journal of Sound and Vibration* **362**, 252–275 (2016)
- [59] Delnevo, A., Le Saint, S., Sylvand, G., Terrasse, I.: Numerical methods - fast multipole method for shielding effects. In: 10th AIAA/CEAS Aeroacoustics Conference. AIAA 2005-2971, Seattle, WA, USA (2005)
- [60] Balin, N., Sylvand, G., Robert, J.: Fast methods applied to BEM solvers for acoustic propagation problems. In: 22nd AIAA/CEAS Aeroacoustics Conference. AIAA 2016-2712, Lyon, France (2016)
- [61] Moreau, S., Roger, M.: Back-scattering correction and further extensions of Amiet's trailing-edge noise model. Part ii: Application. *Journal of Sound and Vibration* **323**(1), 397–425 (2009). <https://doi.org/10.1016/j.jsv.2008.11.051>
- [62] Jordan, P., Jaunet, V., Towne, A., Cavalieri, A.V.G., Colonius, T., Schmidt, O., Agarwal, A.: Jet-flap interaction tones. *Journal of Fluid*

Mechanics **853**, 333–358 (2018). <https://doi.org/10.1017/jfm.2018.566>.  
Accessed 2019-08-12

- [63] Nogueira, P.A.S., Cavalieri, A.V.G., Jordan, P.: A model problem for sound radiation by an installed jet. *Journal of Sound and Vibration* **391**, 95–115 (2016)
- [64] Avanci, M.P., Robinet, J.-C., Jordan, P., Huber, J., Pont, G.: Application of 3D-parabolized stability equations to asymmetric jets. In: 28th AIAA/CEAS Aeroacoustics 2022 Conference (2022)
- [65] Karban, U., Bugeat, B., Agarwal, A., Lesshafft, L., Jordan, P.: An empirical model of noise sources in subsonic jets, formulated in a linear resolvent framework. In: 28th AIAA/CEAS Aeroacoustics 2022 Conference (2022)