

# Experimental tests of the calibration of high precision differential astrometry for exoplanets

Manon Lizzana (1,2,3), Fabien Malbet (1), Pierre Kern (1), Fabrice Pancher (1), Sébastien Soler (1), Thierry Lepine (4), Alain Leger (5)

## Scientific objectives

- Investigate the nature of the dark matter in the Milky way
- Study compact objects
- Explore planetary systems in the Sun's vicinity and particularly rocky exoplanets in the habitable zone. Draw up a list of potential targets for future spectroscopic missions (LIFE, HWO)

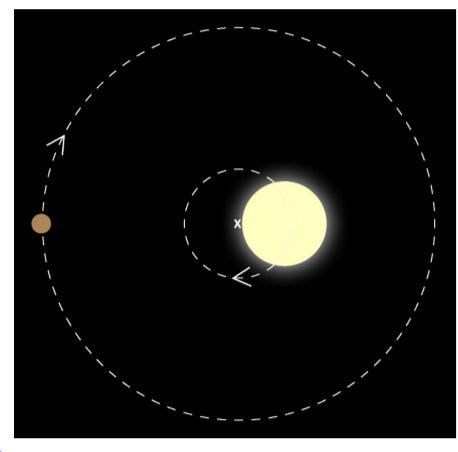

Exoplanets detection by astrometry  
Malbet et al 2012

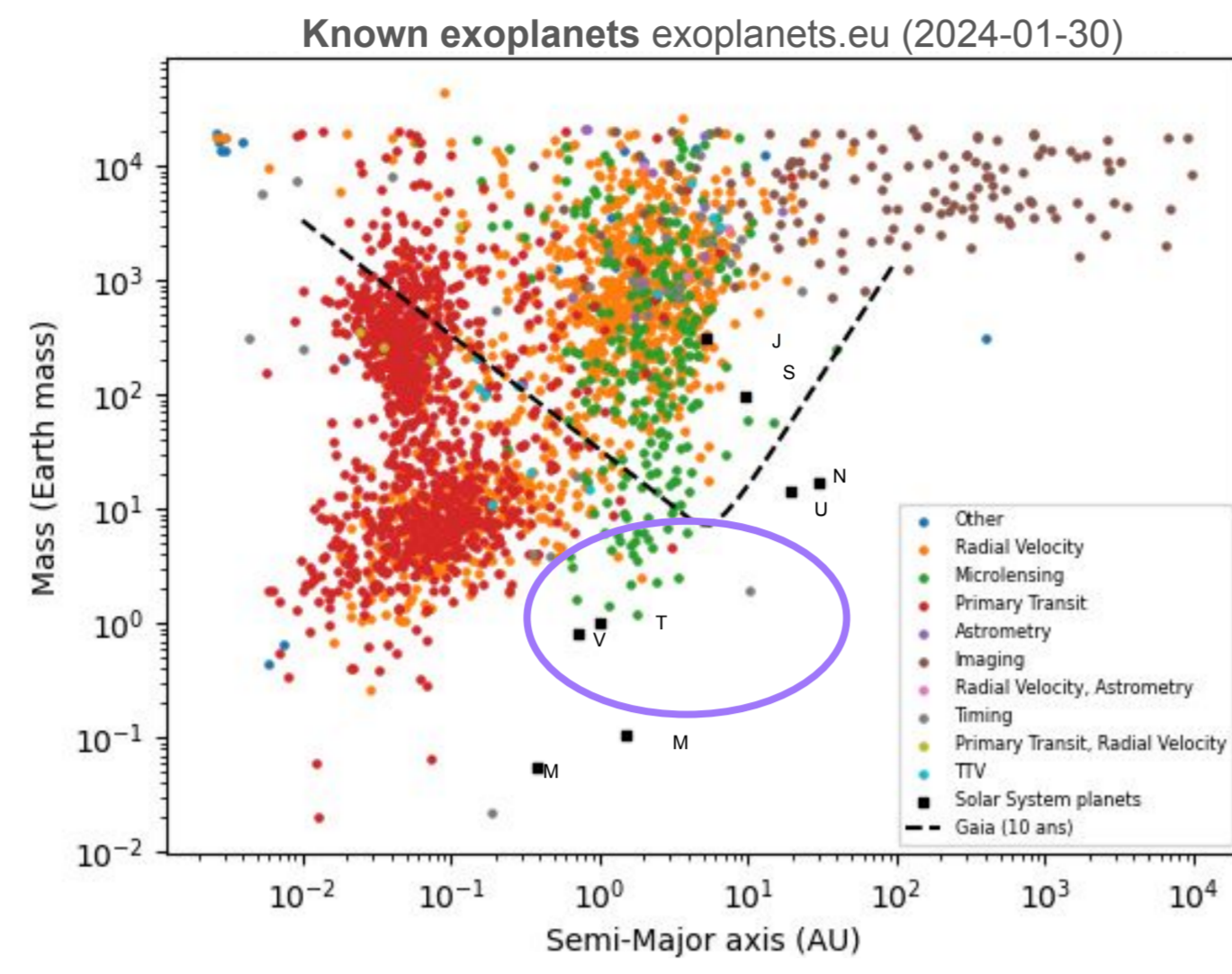
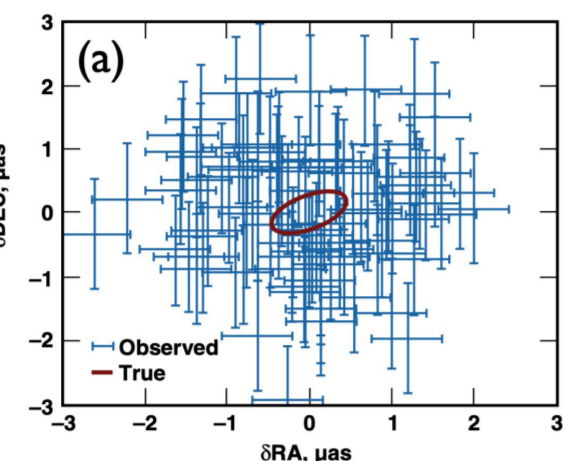

## High precision differential astrometry

Differential astrometry allows to increase the precision on a pointed object. The position, distance and motion of the target object are evaluated relatively to the stars present in the field of view

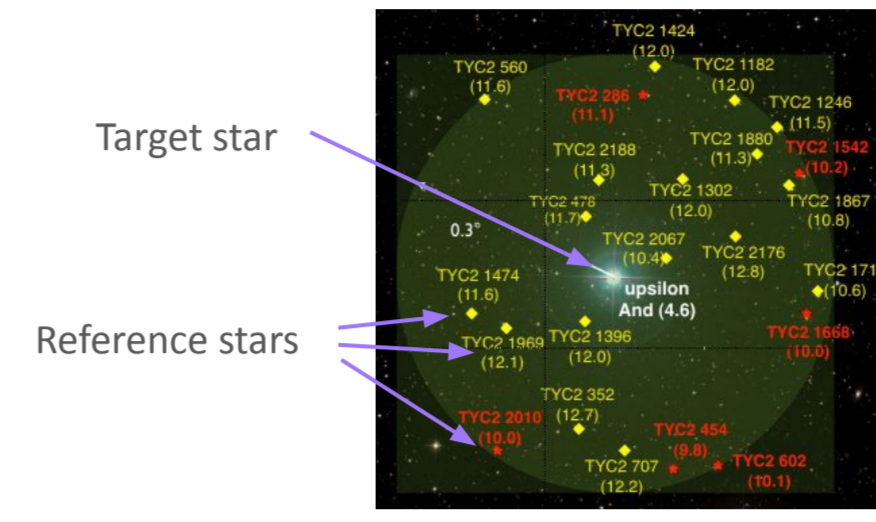

End of the mission required precision :  
0.3 μas ⇔ 5e-6 px ⇔ Calibrations are needed

## Theia mission

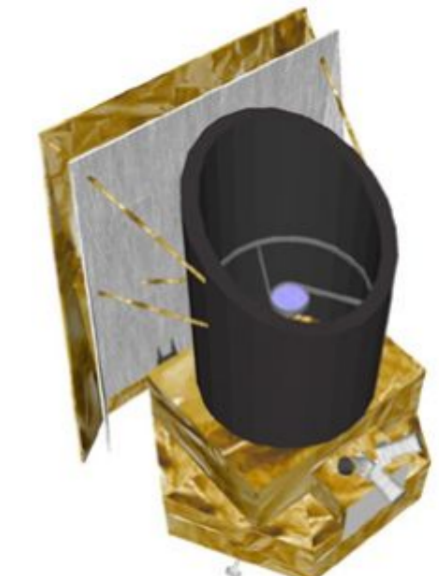

Theia telescope design (Malbet et al. 2021)

- Space telescope
- Diffraction-limited
- 0.8 m in diameter
- A large field of view (0.5°)
- A fine resolution (0.3 μas)
- Stability monitored in real time
- Wavelength : visible

Why not use HWO telescope for high precision astrometry?  
HABITABLE WORLDS OBSERVATORY

## Characterize an adequate CMOS detector

see also poster 194  
Fabrice Pancher

The detectors :

- Need for total field of view coverage :  
30 000 x 30 000 px = 1 Gpx
- Current laboratory experiments :  
Gigapix (Pyxalis) CMOS  
8320 x 5436 px = 46 Mpx  
pixel size : 4.4 μm  
total size : 24 x 26 mm  
λ visible

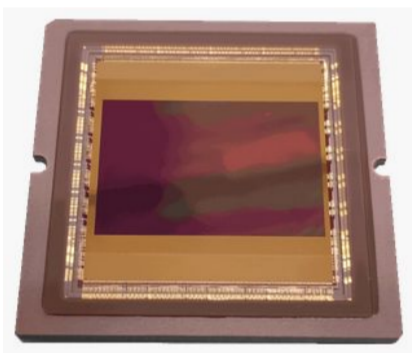

Experimental testbed :

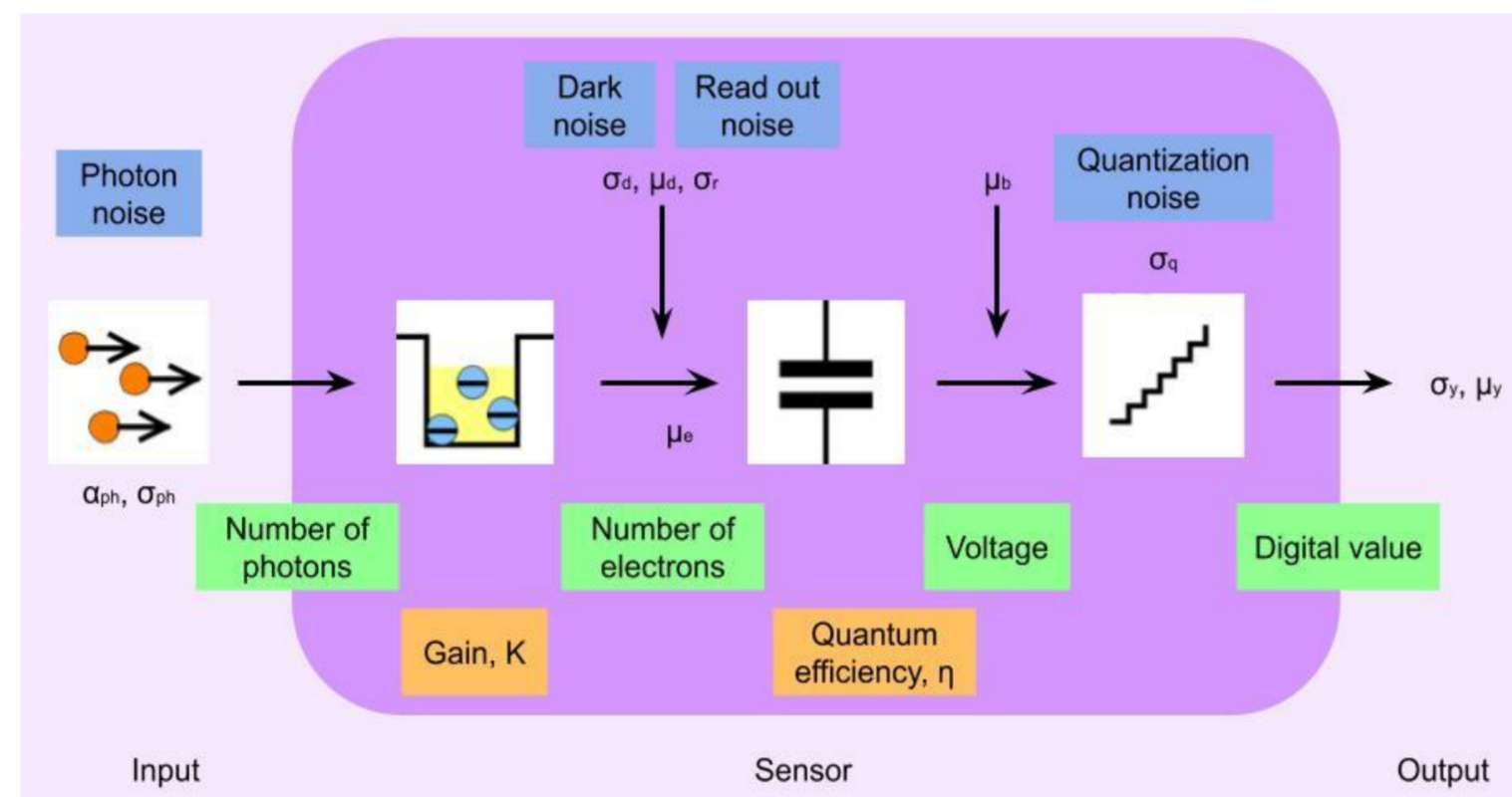
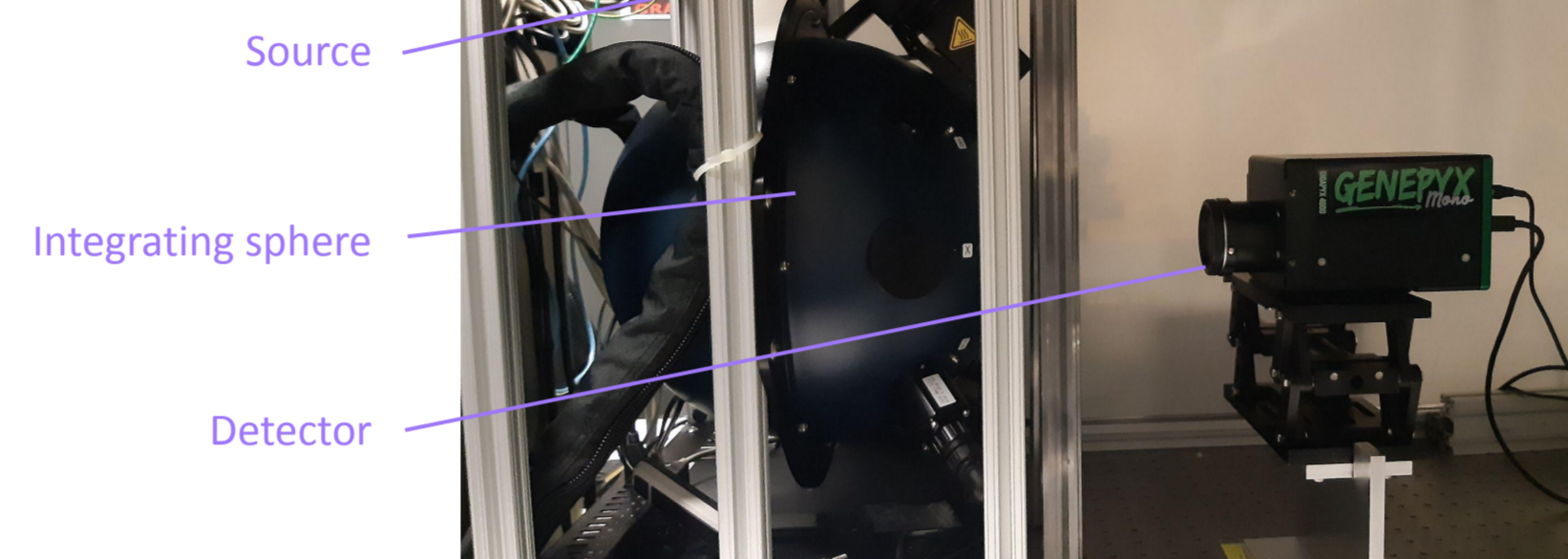

Detector model :

measured signal  
 $\mu_y = \mu_c + \mu_d + \mu_b$   
measured noises  
 $\sigma_y^2 = \sigma_c^2 + \sigma_d^2 + \sigma_r^2 + \sigma_q^2$

Results : Global characterization pixel by pixel (linearity, dark current, readout noise, gain, ...)

|                                   |        |
|-----------------------------------|--------|
| median bias (ADU)                 | 658    |
| std bias                          | 38     |
| median dark current (ADU)         | 0.0074 |
| std dark current                  | 0.0003 |
| linearity error (%)               | 0.64   |
| median readout noise (ADU)        | 0.7    |
| std readout noise                 | 0.2    |
| median gain (ADU/e-)              | 0.71   |
| std gain                          | 0.05   |
| pixel response non uniformity (%) | 2.6    |

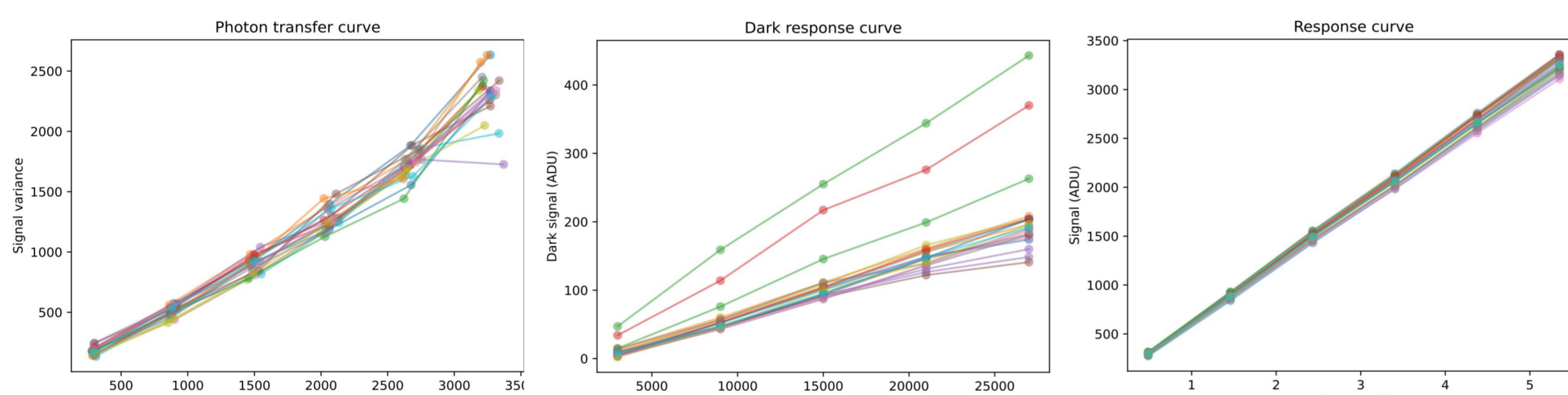

## Interferometric calibration of the pixel centroid position

In a theoretical detector (a), row and columns are well aligned, but in a real detector (b) the centroids are misaligned (because of fine pixel structure, quantum efficiency local variations ...)

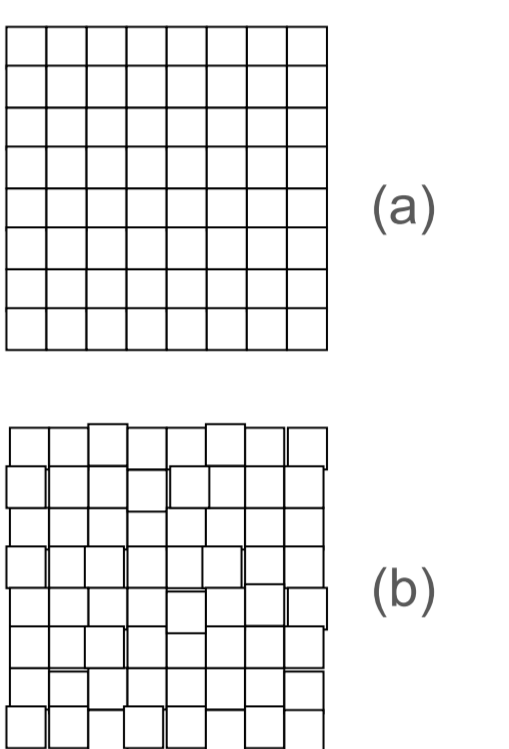

→ Need of calibration

Calibration procedure :

- Fibres create Young's fringes on the detector
- Phase modulators make the fringes scroll
- The modulation observed by each pixel provides the position of the centroids

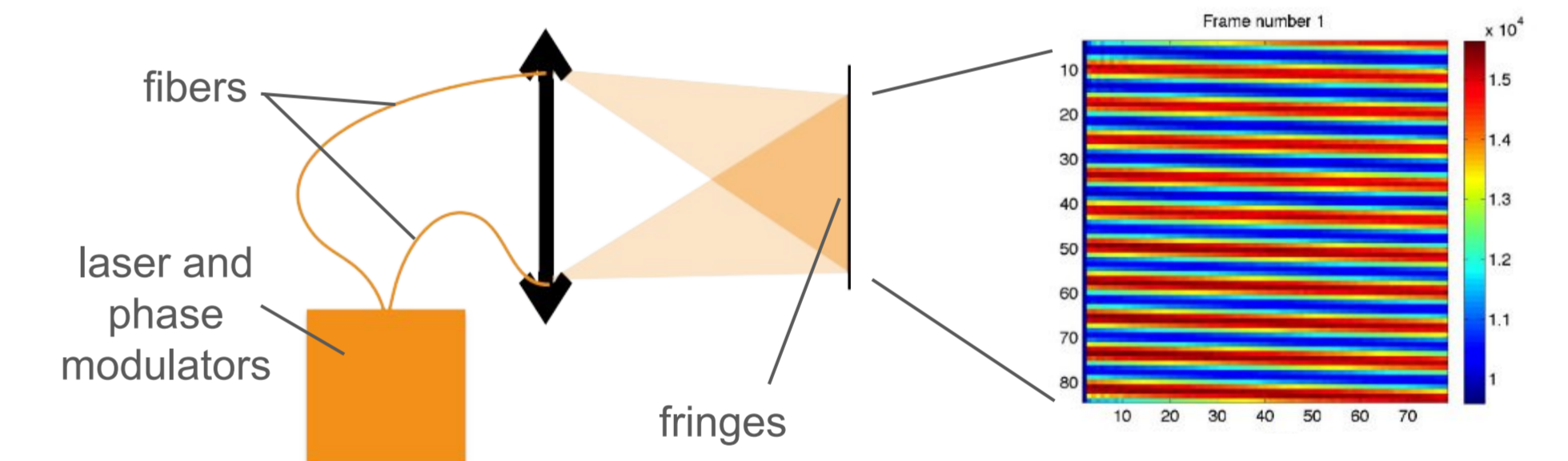

- Proof of concept on small matrices (Crouzier et al. 2016, A&A 595, A108) : 6e-5 px
- performance needs to be validated on large matrices → a testbed will be developed at IPAG

## Calibration of optical distortion

★ with simulations :

Objectiv. Show that a polynomial model is able to calibrate the telescope distortion with a precision smaller than 5e-6 px (corresponding to Earth like planet signal)  
Recent work on telescope stability (Malbet et al. 2022, SPIE 12180, 1F) has shown that the reference stars in the field of the telescope can be used as metrology sources in order to compute the distortion function

- model the field distortion function by a 2D polynomial (T or T1oT2)
- Adjust T thanks to the reference stars in the field of view known with Gaia catalog
- Apply T to the target star to recover its undistorted position

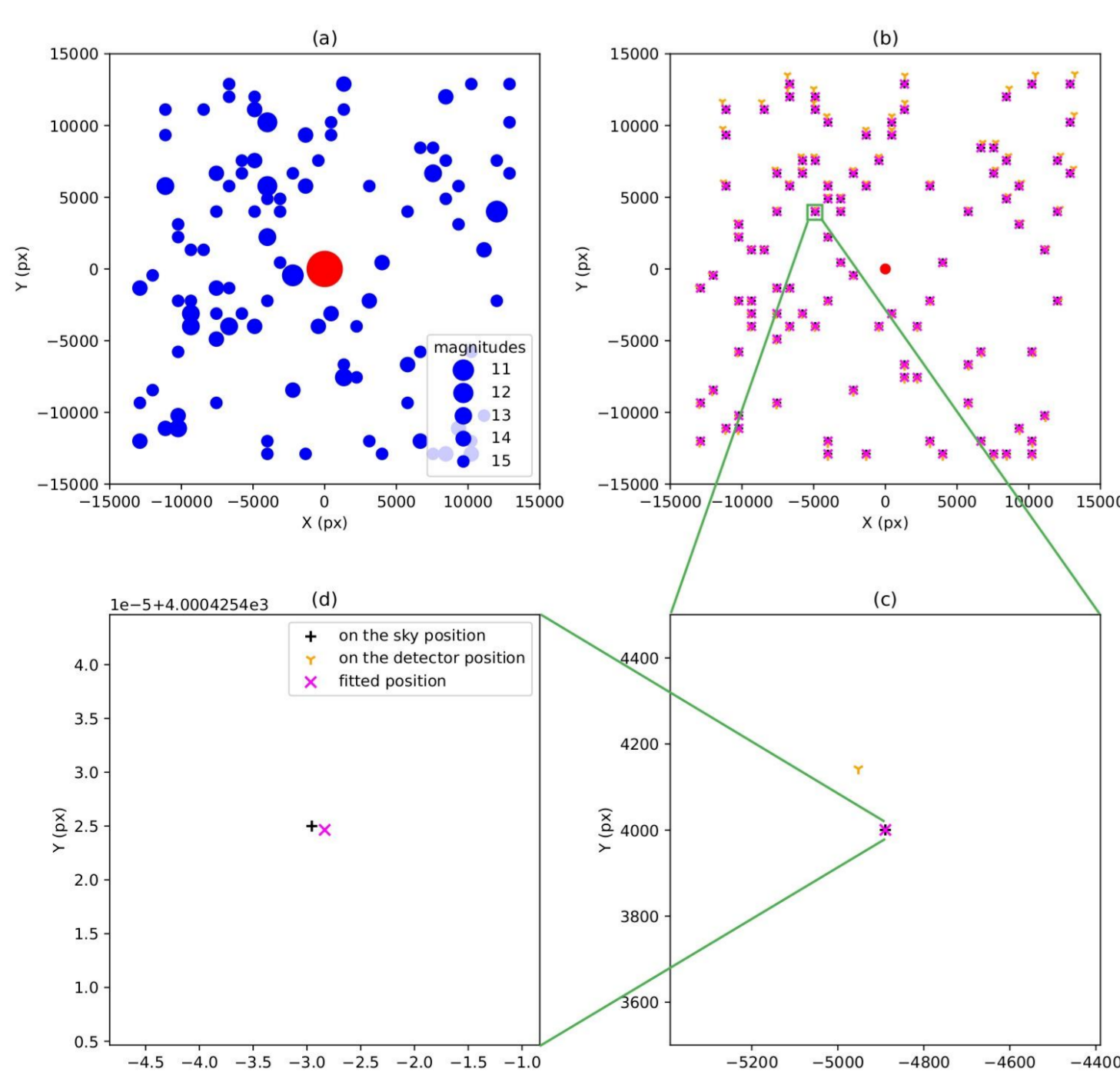

Example of distortion calibration by polynomials with simulated field of view (with optical computing with zeemax)

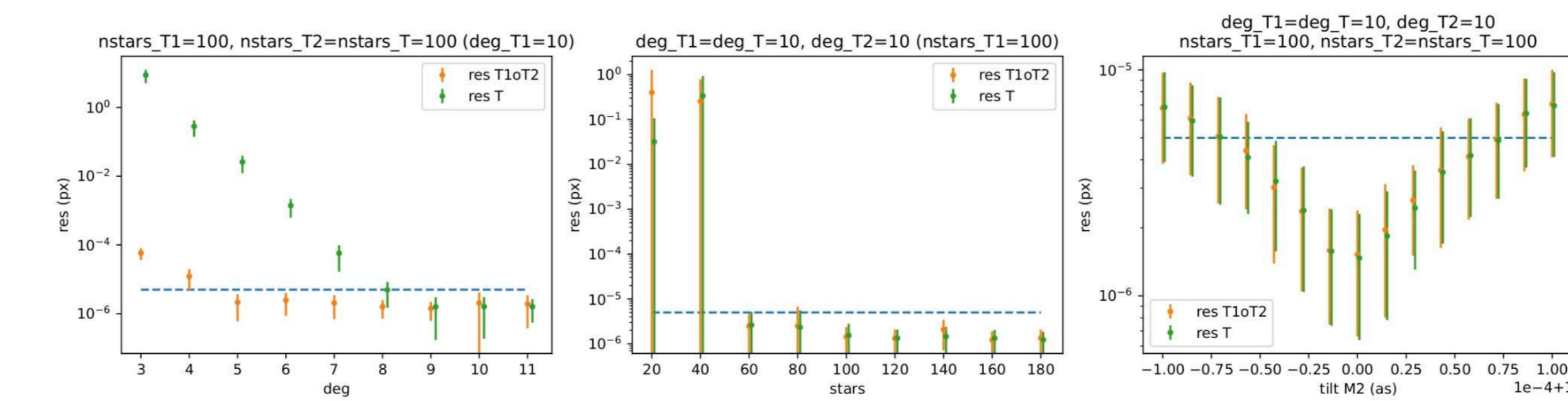
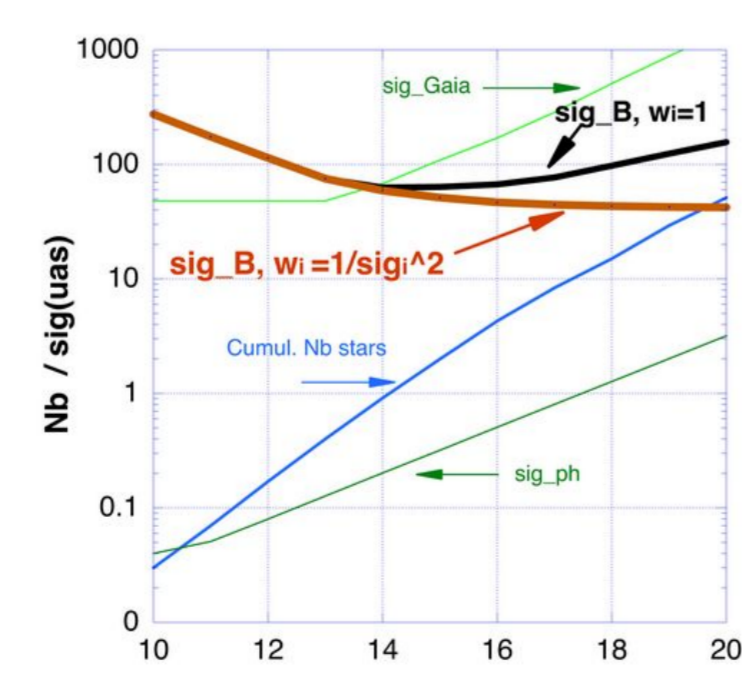

Conclusion : A precision of 5e-6 px can be reached with about 100 stars and an 8th order polynomial

★ in laboratory :

Objectiv. show that the procedure described before works in laboratory

- Illuminating pseudo stars on the led screen
- Induce distortion with lens and diaphragm
- Recording distorted star images with the detector
- Apply the previous procedure to recover the undistorted image

