



HAL
open science

Conformally invariant boundary arcs in double dimers

Marcin Lis, Lucas Rey, Kieran Ryan

► **To cite this version:**

Marcin Lis, Lucas Rey, Kieran Ryan. Conformally invariant boundary arcs in double dimers. 2024. hal-04744468

HAL Id: hal-04744468

<https://hal.science/hal-04744468v1>

Preprint submitted on 18 Oct 2024

HAL is a multi-disciplinary open access archive for the deposit and dissemination of scientific research documents, whether they are published or not. The documents may come from teaching and research institutions in France or abroad, or from public or private research centers.

L'archive ouverte pluridisciplinaire **HAL**, est destinée au dépôt et à la diffusion de documents scientifiques de niveau recherche, publiés ou non, émanant des établissements d'enseignement et de recherche français ou étrangers, des laboratoires publics ou privés.

CONFORMALLY INVARIANT BOUNDARY ARCS IN DOUBLE DIMERS

MARCIN LIS, LUCAS REY AND KIERAN RYAN
(with an appendix by Avelio Sepúlveda)

ABSTRACT. We consider two different versions of the double dimer model on a planar domain, where we either fold a single dimer cover on a symmetric domain onto itself across the line of symmetry, or we superimpose two independent dimer covers on two, almost identical, domains that differ only on a certain portion of the boundary. This results in a collection of loops and doubled edges that, unlike in the classical double dimer case of Kenyon, are accompanied by arcs emanating from the line of symmetry or the chosen portion of the boundary. We argue that these arcs together with the associated height function satisfy a discrete version of the coupling of Qian and Werner between the Arc loop ensemble (ALE) and two different variants of the Gaussian free field (with Dirichlet and Neumann boundary conditions). We also show that certain statistics of the arcs (when the loops are disregarded from the picture) converge to conformally invariant quantities in the small-mesh scaling limit, and moreover the limits are the same for the two versions of the model, and equal to the corresponding statistics of the arc loop ensemble (ALE). This gives evidence to the conjecture of [7] (that concerns one of these models).

1. INTRODUCTION

Motivation. We consider two different but closely related versions of the double dimer model defined on planar graphs, that give rise not only to a collection of loops and doubled edges as in the original work of Kenyon [17] but also to a collection of arcs emanating from and ending at a chosen piece of the boundary (see Figure 1). These arcs are a new feature of the model that does not appear in the original double dimers, and our main goal is to study their statistics (when the loops are disregarded from the picture). One of these two constructions was described in [7], where a conjecture about the scaling limit of the arcs was stated claiming that the full collection of arcs should converge to the so-called *arc loop ensemble (ALE)* introduced by Aru, Sepúlveda and Werner in [4]. Here we develop the methods of [17] to fit this setup and use them to give (partial) evidence for this conjecture. To be precise, we compute the scaling limits of certain observables of the arcs themselves, and they turn out to be conformally invariant and agree with the analogous quantities defined directly for the ALE.

Our motivation (outside of the dimer model) comes from the theory of the continuum *Gaussian free field (GFF)* and its level sets. The GFF with *Dirichlet* boundary conditions in a domain D is a Gaussian field whose covariance kernel is given by the Green's function $g(x, y)$ of Brownian motion in the domain with Dirichlet boundary condition. In this article we assume that the Green's function is normalised so that $g(x, y) \sim (-2\pi)^{-1} \log |x - y|$

Date: September 27, 2024.

Marcin Lis: Vienna University of Technology, marcin.lis@tuwien.ac.at.

Lucas Rey: CEREMADE, Université Paris-Dauphine, Université PSL, CNRS, 75016 Paris, France and DMA, École normale supérieure, Université PSL, CNRS, 75005 Paris, France, lucas.rey@dauphine.psl.eu.

Kieran Ryan: Vienna University of Technology, kieran.ryan@tuwien.ac.at.

as $x \rightarrow y$ in the interior of the domain. We are guided by the construction of Qian and Werner [19] who coupled two different versions of the GFF, with Dirichlet and *Neumann (free)* boundary conditions (we refer the reader to [19] for a definition of the latter), through a common set of level lines that form an ALE.

Even though the GFF is not a function, but only a generalised function (a Schwartz distribution acting on test functions), a beautiful theory of its level sets has been developed in recent years [4, 3, 2]. An important notion in this geometric representation of the GFF is that of the two-valued sets $\mathbb{A}_{-a,b}$, where $a, b > 0$, $a + b \geq 2\lambda$, and where $\lambda = \sqrt{\pi/8}$ is the constant appearing in the height-gap phenomenon of Schramm and Sheffield [21]. Formally they are thin local sets in the sense of [4] whose associated harmonic function takes only two values $-a$ and b . Heuristically they are random sets naturally coupled with the GFF that could be seen as sets of those points in D that are connected to ∂D by a path on which the values of the field (which is not defined pointwise) lie between $-a$ and b . The ALE is then the set of arcs given by the (restriction to D of the) connected components of $A_{-\lambda,\lambda}$. In [19] a surprising coupling between the ALE and two different types of the GFF was given. In this construction, the Dirichlet GFF (with zero boundary conditions) changes its value by $\pm 2\lambda$ across the arcs of the ALE in a deterministic and alternating fashion, whereas the Neumann (free boundary condition) GFF changes its value by $\pm 2\lambda$ in an i.i.d. fashion.

Discrete models and couplings. In this article we consider a set of discrete arcs in two different but related versions of double dimers that satisfy an analogous coupling when considered together with the associated height function (that is known to converge to the Gaussian free field in a variety of settings [16, 20, 6, 14]). To be precise, recall that the *dimer model* is a random perfect matching (which in the setting of this work is chosen uniformly at random) of a finite graph. We will assume that the graph is a finite connected subgraph of the rescaled square lattice $\epsilon\mathbb{Z}^2$ that is symmetric across the real line, and whose restriction to the upper half-plane approximates a simply connected continuum domain U . We will denote such graphs by \mathcal{G}_ϵ^r .

In the first setup, referred to as *folded dimers*, that corresponds to the Neumann GFF in the coupling of [19], we consider the dimer model on \mathcal{G}_ϵ^r , and fold the resulting perfect matching along the real line as in Fig. 1. This results in a collection of loops, doubled edges, and arcs starting and ending on the real line. The associated height function on the faces of the folded graph can be defined (up to a global additive constant) by assigning orientations to each dimer in the folded dimer cover: each dimer coming from the top half of \mathcal{G}_ϵ^r is oriented from a black to a white vertex (in a fixed bipartite colouring of the lattice), and each dimer coming from the bottom half is oriented from a white vertex to a black vertex. This results in a consistent orientation of each loop and arc, and finally one declares that the increment of the height function from a face u to a neighbouring face is $+1$ (resp. -1) if there is a loop or an arc separating the two faces such that u lies on the left-hand (resp. right-hand) side of the oriented dimer in the loop or arc. Note each loop and arc can be oriented in the two possible ways with equal probability and independently of other loops and arcs. This corresponds to the increment of the height function being ± 1 , and is analogous to the coupling of Qian and Werner between the ALE and the GFF with mixed Neuman/Dirichlet boundary conditions.

One can see that the height function in this setting does indeed converge to the continuum GFF with mixed Neuman/Dirichlet boundary conditions. Indeed, it is known from the original work of Kenyon [16] (and more recent generalisations [20, 6]) that if the dimer model on \mathcal{G}_ϵ^r has *Temperleyan* boundary conditions (which we assume to be the case in our arguments

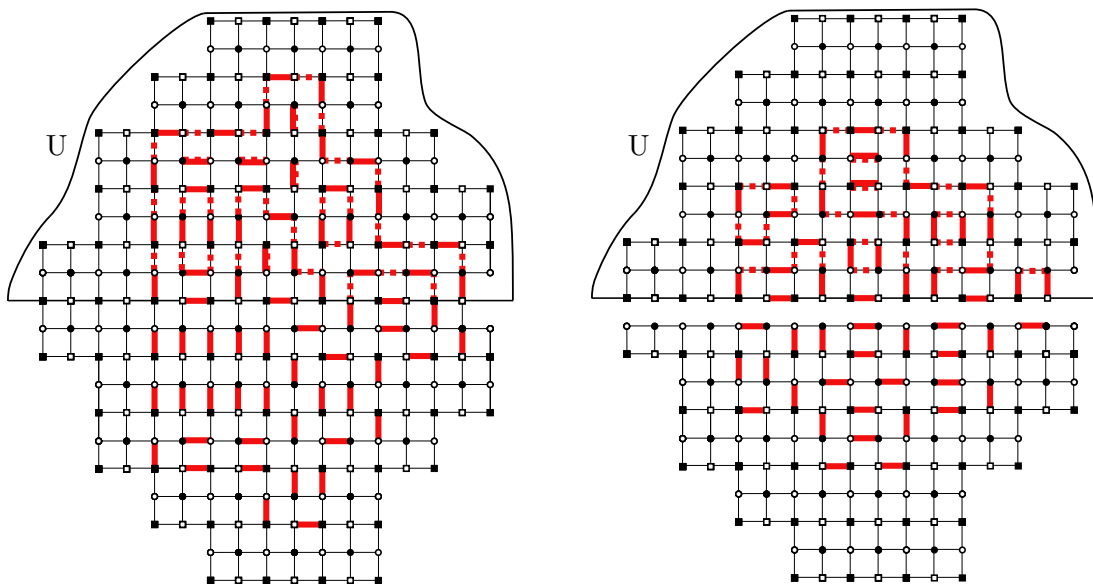

FIGURE 1. **Left:** a (partial) dimer cover of $\mathcal{G}_\varepsilon^r$ is represented in red, and the lower part is folded on the upper part in dotted red. A folded dimer configuration appears on the upper part: loops and arcs alternate between full red and dotted red. The graph $\mathcal{G}_\varepsilon^r$ has Temperleyan boundary conditions: all its corners are black squares, and one of the black squares on the boundary (in this case on the right-hand side of the intersection with the real line) is removed. **Right:** (partial) dimer covers of $\mathcal{G}_\varepsilon^r \cap \mathbb{R} \times \mathbb{R}_{\geq 0}$ and $\mathcal{G}_\varepsilon^r \cap \mathbb{R} \times \mathbb{R}_{< 0}$ are represented in solid red. The lower part is superimposed on the upper part in dotted red. A superimposed configuration appears on the upper part: loops and arcs alternate between full red and dotted red. The upper part has again Temperleyan boundary conditions, and the lower part has piecewise Temperleyan boundary conditions with two white bullet corners. The sets of vertices W_0 and B_0 are represented by white and black bullets, W_1 and B_1 are represented by white and black squares.

as is shown in Fig. 1 and Fig. 11), then the *centered* height function of the dimer model on $\mathcal{G}_\varepsilon^r$, multiplied by 2λ to match the height gap across the continuum level lines, converges as $\varepsilon \rightarrow 0$ to $1/\sqrt{2}$ times the Dirichlet GFF in the symmetric domain U^r whose restriction to the upper half plane is U (i.e. $U^r = U \cup \bar{U} \cup (\partial U \cap \{0\} \times \mathbb{R})$). We note that here we take into account the fact that the height function of a single dimer model defined in [16] is 4 times the height function we are using in this article. From this definition it is clear that the expectation of the height function on $\mathcal{G}_\varepsilon^r$ is antisymmetric across the real line, and that the height function at a face u in the folded dimer model is by definition equal to the sum of the height functions at u and at its reflection \bar{u} in the single dimer model on $\mathcal{G}_\varepsilon^r$. Since the continuum GFF in U with Neumann boundary conditions on the real line and Dirichlet boundary conditions on the rest of ∂U can be obtained in the same way from $1/\sqrt{2}$ times the Dirichlet GFF in U^r (as e.g. described in [19, 7]), we can conclude that 2λ times the height function defined by the discrete loops and arcs converges to exactly the same GFF

with mixed boundary conditions as in the coupling of [19].

In the second setup, we first remove the row of vertical edges of $\mathcal{G}_\varepsilon^r$ just below the real line (see Fig. 1) and then repeat the folding procedure as in the first setup. This results in a number of differences compared to the previous case. The first one is that now the arcs emanating from the real line cannot have arbitrary orientations. Indeed, one quickly realises that due to parity reasons the arcs must deterministically alternate in orientation – just as in the part of the coupling in [19] concerning the Dirichlet GFF. Moreover, after the removal of edges the graph splits into two connected components $\mathcal{G}_\varepsilon^r \cap \mathbb{R} \times \mathbb{R}_{\geq 0}$ and $\mathcal{G}_\varepsilon^r \cap \mathbb{R} \times \mathbb{R}_{< 0}$. One can check that the upper component has again Temperleyan boundary conditions, whereas the lower one has *piecewise Temperleyan* boundary conditions (see Fig. 1) introduced by Russkikh [20], who proved convergence of 2λ times the *centered* height function to $1/\sqrt{2}$ times the Dirichlet GFF. Later Berestycki and Liu showed [8, Theorem 5.1] that the mean of 2λ times the height function converges to a harmonic function with piecewise constant boundary conditions with alternating jumps of size $\pm\lambda$ located at the points of the *Temperleyan corners* (in our case these are the two extremities of $\partial U \cap \{0\} \times \mathbb{R}$) plus a term that involves the winding of the boundary of U . Since U and \bar{U} have opposite windings of the boundary, they cancel out when the two height functions are added, and we can conclude that the mean of 2λ times the height function of the superimposed configuration converges to the harmonic function in U with λ boundary conditions on $\partial U \cap \{0\} \times \mathbb{R}$ and zero elsewhere. Since the sum of two independent fields that are both $1/\sqrt{2}$ times the Dirichlet GFF (coming from the upper and lower domains) is (1 times) the Dirichlet GFF, we can conclude that 2λ times the height function of our model converges to the corresponding field described in [19], i.e. a GFF in U with boundary conditions equal to λ on $\partial U \cap \{0\} \times \mathbb{R}$ and zero on the rest of ∂U .

We conjecture (on top of the conjecture of [7] that concerns the first model) that the arcs in both models converge to the ALE in U (emanating from $\partial U \cap \{0\} \times \mathbb{R}$ as in [19]). This is strongly evidenced by the discussion above. However, convergence of the height function is known not to be enough to conclude convergence of interfaces in the double dimer model [17, 13, 5]. Finally let us mention that the two models yield different measures in the discrete setting, when one forgets the orientation of loops and arcs. Indeed, in the first model each nontrivial arc (that is not a single edge) comes with a combinatorial factor of two corresponding to the two different orientations, and it comes with a factor of one in the second model. The number of nontrivial arcs is not constant (unlike the number of all arcs) and hence the measures are different. Nonetheless we conjecture that the two collections of arcs have the same scaling limit.

Main results. The main observables of interest in both models will be $n_\varepsilon(z)$ – the number of arcs that surround a point z , i.e. arcs that separate z from the part of the boundary with no arcs $\partial U \setminus \{0\} \times \mathbb{R}$, and $o_\varepsilon(z)$ – the parity of $n_\varepsilon(z)$. Our main result can be summarised as follows.

THEOREM 1.1. *In both models, as $\varepsilon \rightarrow 0$ the laws of $n_\varepsilon(z)$ and $o_\varepsilon(z)$ converge in distribution to random variables $n(z)$ and $o(z)$ whose laws are independent of the model and moreover are conformally invariant.*

We refer to Theorem 3.4 and Corollary 3.5 for the general statements, and to Example 3.7 for a particular example of the infinite strip $U^r = [-\infty, +\infty] \times [-\pi/2, \pi/2]$.

Moreover we give integral representations of the moments of $n_\varepsilon(z)$, and compute its mean explicitly. In particular, on the infinite strip we show that, as $\varepsilon \rightarrow 0$,

$$\mathbb{E}_\varepsilon[n_\varepsilon(z)] \rightarrow \frac{1}{4} - \frac{y^2}{\pi^2} - \frac{2}{\pi^2} \ln(\sin(y)),$$

which agrees with the mean of the same random variable defined directly for the ALE (as computed by Avelio Sepúlveda in Appendix A). We note that our methods could be extended to analyse the distribution of the number of arcs separating two chosen points in the domain.

One of the main conceptual difficulties in approaching the problem of studying the arcs themselves is the issue of separating the loops from the arcs in the counting arguments. This is achieved by developing a novel Kenyon's formula for double dimers with arcs, and afterwards choosing the right weights (or more precisely $SL(2)$ connections) in this formula. Afterwards an involved analysis of the scaling limit of the formula by means of discrete complex analysis techniques is required.

We note that the works [17, 13, 5] study multi-point functions of topological observables in the double dimer model. Basok and Chelak [5] showed that these observables contain enough information to identify the law of the loops. In our case, the fact that we want to disregard all the loops from the picture restricts greatly the number of useful topological observables, and we can only treat the one-point (or two-point) function. However, it will be very interesting to develop the methods of [17, 13, 5] to study the full collection of both arcs and loops, that (based on the conjecture of Kenyon [17]) and our conjectures should converge to the ALE with an independent CLE_4 in its complement.

Organisation of the article.

- In Sect. 2 we give a new combinatorial interpretation and also generalise Kenyon's formula for double dimers from [17] to the setting that includes arcs. We note that such formulas can also be obtained from the independent work of Douglas, Kenyon and Shi [12] who studied n -multiwebs on planar graphs.
- In Sect. 3 we define the two versions of the model described above, and state the main result (Theorem 3.4) for both of them.
- In Sect. 4 we prove the main theorem in the folded dimers model.
- In Sect. 5 we prove the main theorem in the shifted dimers model (we elaborate on the differences with the proof in Sect. 5).
- In Sect. 6, we consider a case of a symmetric domain with two pieces of the boundary from which the arcs emanate, and we compute explicitly the distribution of the arcs that connect the two boundary pieces together.
- In App. A (due to Avelio Sepúlveda) a continuum computation of the expected number of arcs in ALE surrounding a point is presented.
- In App. B, we recall the asymptotic estimates of the inverse Kasteleyn matrix for the dimer model in Temperleyan domains obtained by Kenyon in [15]. We detail some arguments concerning the behaviour near the boundary.
- In App. C, we recall the extension of the results of App. B to piecewise Temperleyan domains obtained by Russkikh in [20]. We also explain how to write the limit in terms of the conformal invariant quantities that are useful to us in folded domains.

Acknowledgements. The authors extend their warm thanks to Avelio Sepúlveda for his contribution of Appendix A. ML and LR thank Misha Basok for useful discussions during the program *Geometry, Statistical Mechanics, and Integrability* at IPAM, UCLA. ML and KR were supported by the FWF Standalone grant Spins, Loops and Fields P 36298 and the SFB

Discrete Random Structures F 1002. KR was supported by the Academy of Finland Centre of Excellence Programme grant number 346315 “Finnish centre of excellence in Randomness and Structures” (FiRST). LR was partially supported by the DIMERS project ANR-18-CE40-0033 funded by the French National Research Agency.

2. KENYON’S FORMULA

2.1. Setup and formula. We begin with some definitions. Let $G = (V, E)$ be a finite, connected, bipartite, planar graph. Its vertices V are partitioned into white and black vertices. Let ∂ be a *strict* subset of the vertices incident to the external face of G , which contains the same number of black and white vertices. We form a graph G^\times which can be described as taking two copies of G , identifying the vertices in the two copies on ∂ , and then adding “diagonal” edges which join a vertex u in one copy of G to a vertex v in the other copy, whenever u and v form an edge in G . One can think of the two copies of G being “folded” together along ∂ .

Formally, we write $G^\times = (V^\times, E^\times)$ for the graph with vertex set $V^\times := \partial \cup ((V \setminus \partial) \times \{1, 2\})$, and edge set E^\times given by edges:

- $\{(u, i), (v, j)\}$ for all $i, j = 1, 2$ and $u, v \in V \setminus \partial$ such that $\{u, v\} \in E$;
- $\{(u, i), w\}$ for all $i = 1, 2$ and $u \in V \setminus \partial$, $w \in \partial$ such that $\{u, w\} \in E$;
- $\{w, w'\}$ for all $w, w' \in \partial$ and $\{w, w'\} \in E$.

This graph is also bipartite, and we define the colour (white or black) of (u, i) as the colour of u . We denote by p the *projection* from G^\times onto G : for all $u \in V^\times \cap \partial$, $p(u) = u$, for all $(u, i) \in V^\times$, $p(u, i) = u \in V$ and for all $\{x, y\} \in E^\times$, $p(\{x, y\}) = \{p(x), p(y)\} \in E$.

A dimer configuration on G^\times is a set of edges $m \subset E^\times$ such that every vertex in V^\times is incident to exactly one edge in m . The projection of a dimer configuration m is the set of edges $p(m) \subset E$ obtained by projecting all edges of m . In the case $\partial = \emptyset$, the projection of a dimer configuration on G^\times is a configuration of disjoint closed loops and double edges on G : it is a double dimer configuration. In the case $\partial \neq \emptyset$, the projection of a dimer configuration on G^\times is a configuration of disjoint closed loops, double edges, and also paths from ∂ to ∂ , which we call *arcs* (the arcs can be of length 1). Let Ω denote the set of such configurations of loops, double edges, and arcs on G .

Let Φ be some $\mathrm{SL}_2(\mathbb{C})$ connection on the bulk of G . That is, Φ assigns each directed edge uv ($u, v \in V \setminus \partial$) a matrix $\phi_{u,v} \in \mathrm{SL}_2(\mathbb{C})$, such that $\phi_{v,u} = \phi_{u,v}^{-1}$. For a loop $C = \{e_1, \dots, e_{2n}\}$ in G , define the monodromy of Φ around C , ϕ_C to be the product $\phi_{e_1} \circ \dots \circ \phi_{e_{2n}}$. Note this depends on the choice of e_1 and the orientation of the loop; $\mathrm{tr}(\phi_C)$, however, does not. For an edge $\{u, w\}$ with $w \in \partial$ and $u \in V \setminus \partial$, let $\psi_{\{u,w\}} \in \mathbb{C}^2$. Fix some basis of each copy of \mathbb{C}^2 so that each $\phi_{v,u}$ can be written as a matrix, and each $\psi_{\{u,w\}}$ as a column vector.

We say a set of Kasteleyn phases on the edges of a bipartite, planar graph G is a function $\xi : E \rightarrow \mathbb{C}$ with $|\xi_e| = 1$ for all $e \in E$, such that for every simple loop of edges $e_1 \dots e_{2n}$ in G , one has

$$\frac{\xi_{e_1} \xi_{e_3} \cdots \xi_{e_{2n-1}}}{\xi_{e_2} \xi_{e_4} \cdots \xi_{e_{2n}}} = (-1)^{n+1}. \quad (1)$$

It is well known that such phases exist (see for example Theorem 4.1 of [10]) and in fact can be taken to be real i.e. signs ± 1 on the edges. One can show that (1) holds for all loops surrounding an even number of vertices. Moreover if one replaces $\xi_{x,y}$ by $\varepsilon(x)\varepsilon(y)\xi_{x,y}$ for some function $\varepsilon : V \rightarrow \{\pm 1\}$, the new phases are also a set of Kasteleyn phases: this is called a gauge transform. Let $\bar{\partial}$ be a connected, strict subset of the boundary vertices, with $\partial \subset \bar{\partial}$.

By using a gauge transform, one can assume that the phases on the boundary edges (incident to the external face) alternate between $+1$ and -1 in $\bar{\partial}$. We fix such real phases ξ for the rest of this section.

We assign weights $\nu(e)$ to the (undirected) edges of G^\times as follows. If $\{(u, i), (v, j)\}$ is some edge in the bulk of G^\times , with u white and v black, let $\nu_{\{(u,i),(v,j)\}} := (\phi_{u,v})_{i,j}$, (the i, j entry of $\phi_{u,v}$). If $w \in \partial$ and (u, i) is adjacent to w but not in ∂ , we set $\nu_{\{(u,i),w\}} = (\psi_{\{u,w\}})_i$. If $w, w' \in \partial$ then let $\nu_{\{w,w'\}} = 1$. Let K be an antisymmetric matrix whose rows and columns are indexed by vertices of G^\times , defined as follows. For $x, y \in V^\times$ with x white and y black, let

$$K_{x,y} = \xi_{p(x),p(y)} \nu_{x,y},$$

and let $K_{y,x} = -K_{x,y}$, where ξ are the Kasteleyn phases.

We assign an ordering to V^\times which will be used in the Pfaffian of Proposition 2.1. Let the ordering be: first the boundary vertices, ordered as they appear clockwise in $\bar{\partial}$, then the white vertices in some order such that each $(u, 1)$ is directly followed by $(u, 2)$, and then the black vertices, again in some order such that $(v, 1)$ is directly followed by $(v, 2)$. We can write our assumption that the Kasteleyn phases alternate on the boundary as $\xi_{w,b} = (-1)^{\mathbb{1}\{w>b\}}$ for all edges linking two vertices of $\bar{\partial}$.

A set of Kasteleyn phases satisfying this hypothesis is depicted in Figure 2, where $\partial = \bar{\partial}$ is the set of edges on the x -axis.

PROPOSITION 2.1. *[Kenyon's formula] We have that*

$$\text{Pf}K = \sum_{\omega \in \Omega} \prod_{\text{loops } C} \text{tr}(\phi_C) \prod_{\text{arcs } A} \psi_{w_A}^\top \phi_A \psi_{b_A}, \quad (2)$$

where ϕ_C is the monodromy of the connection Φ around the loop C , b_A (resp. w_A) is the black (resp. white) endpoint of the arc A (note that the two endpoints of each arc have different colours), and if e_1, \dots, e_k are the bulk edges of A ordered towards b_A , $\phi_A = \phi_{e_1} \cdots \phi_{e_k}$. When an arc is a single edge e , we interpret the factor corresponding to it as $\nu_e = 1$.

REMARK 2.2. *We note an independent work of Douglas, Kenyon and Shi [11, Theorem 4.1] considers similar interpretations of double dimers as in our proof of this result.*

REMARK 2.3. *A version of the proposition above also holds for other Kasteleyn phases ζ (in particular complex ones) if they can be obtained from the real weighting ξ above by a gauge transformation $\zeta_{u,v} = \varepsilon(u)\varepsilon(v)\xi_{u,v}$, for some $\varepsilon : V \rightarrow \mathbb{C}$. This corresponds, for each $u \in V$, to multiplying the row and column of K corresponding to $(u, 1)$ and $(u, 2)$ (or just u if $u \in \partial$) by $\varepsilon(u)$, which multiplies the Pfaffian by $\varepsilon(u)^2$ (or $\varepsilon(u)$ if $u \in \partial$). One then obtains the right hand side of the proposition, multiplied by the scalar $\prod_{u \in V \setminus \partial} \varepsilon^2(u) \prod_{u \in \partial} \varepsilon(u)$.*

Recall that the usual complex Kasteleyn phases adapted to discrete holomorphy for \mathbb{Z}^2 are given by

$$\zeta_{b,w} = b - w \quad (3)$$

(thinking of $b, w \in \mathbb{C}$), that is, at each white vertex, the weights of the four adjacent edges starting at the right-going edge and proceeding anticlockwise are $1, i, -1, -i$ respectively. Using the gauge function $\varepsilon(u) = (-i)^{\mathbb{1}\{u \text{ has odd vertical coordinate}\}} (-1)^{\mathbb{1}\{u \text{ is white}\}}$, and the real Kasteleyn phases ξ depicted in Figure 2, $\zeta_{u,v} := \varepsilon(u)\varepsilon(v)\xi_{u,v}$ are the Kasteleyn phases of

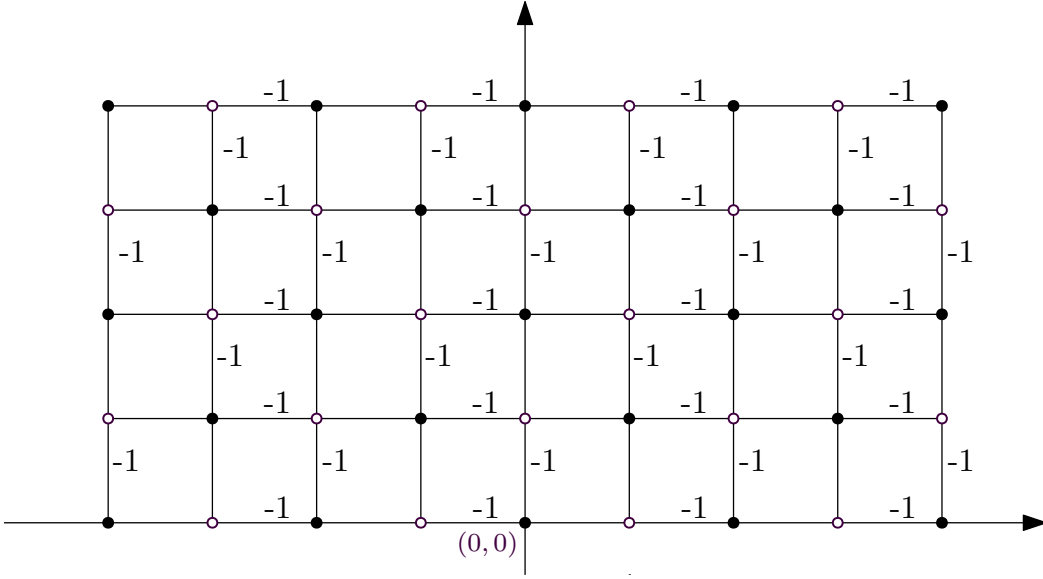

FIGURE 2. An example of a graph G , where we take $\partial = \bar{\partial}$ to be the edges on the x -axis, and real Kasteleyn weights ξ which alternate in sign along $\bar{\partial}$ as $\xi_{w,b} = (-1)^{1_{\{w>b\}}}$, where the ordering on ∂ increases clockwise. (We only write the -1 phases in the diagram for clarity; the rest are 1).

discrete holomorphy of Equation (3). Remark 2.3 gives us the corollary of Proposition 2.1 which we will use in the following sections.

COROLLARY 2.4. *Let G have the conditions from the above, and be a simply connected subgraph of the upper half of \mathbb{Z}^2 . Then (2) holds with K defined using the Kasteleyn phases ζ (up to a global gauge factor of modulus 1).*

2.2. Proof of Kenyon's formula. We use the following formula for a Pfaffian. Place the vertices of G^\times clockwise around the edge of a disc D , in the ordering given above. For a pairing π of the vertices, draw curves in D connecting each of the pairs, producing a set of intersecting curves D_π . Define $k(\pi)$ to be the number of crossings of these curves. The value of $k(\pi)$ depends on how one draws the curves, but $(-1)^{k(\pi)}$ does not. Then

$$\text{Pf}K := \sum_{\pi} (-1)^{k(\pi)} \prod_{\substack{xy \in \pi \\ x < y}} K_{x,y}, \quad (4)$$

where the sum is over all pairings of indices (in our case, the indices are vertices of G^\times). In particular, if the pairing π is given by a dimer configuration m on G^\times , $(-1)^{k(m)}$ is well defined.

Recall that p projects from G^\times to G . By extension, p projects a dimer configuration on G^\times to a configuration $p(m) := \omega$ on G of disjoint loops (which can be of length 2) and arcs from ∂ to ∂ (which can be of length 1). We write Ω for the set of all possible such configurations ω . A dimer configuration m is then specified by $\omega = p(m)$, along with a certain list of indices coming from the two copies for each loop, double edge and arc in ω . The first part of the proof, Lemma 2.5, writes $(-1)^{k(m)}$ in terms of these loops, arcs, and indices.

Let us make this precise. A configuration ω is a set of disjoint loops C and arcs A . Take a loop of length 2 (a doubled edge) in ω , located on some edge $e = \{u, v\}$ with u white and v black. Take an index $i_e \in \{1, 2\}$. One then has (part of) the corresponding dimer configuration, given by the edges $\{(u, 1), (v, 1)\}$ and $\{(u, 2), (v, 2)\}$ if $i_e = 2$ and $\{(u, 1), (v, 2)\}$ and $\{(u, 2), (v, 1)\}$ if $i_e = 1$.

For a loop C in ω of length larger than 2, label its vertices $u_1, v_1, \dots, u_k, v_k$ in counter-clockwise order round the loop, where v_i are all black, u_i all white (See Figure 3). Let $i_1, j_1, \dots, i_k, j_k \in \{1, 2\}$. The dimer configuration corresponding to this list of indices is: for each pair u_l, v_l , let the edge $\{(u_l, i_l), (v_l, j_l)\}$ be in the configuration, and for each pair v_l, u_{l+1} , let the edge $\{(v_l, 3 - j_l), (u_{l+1}, 3 - i_{l+1})\}$ be in the configuration. See Figure 4. In the figure, the vertices on the upper row are $(u_1, 2), (v_1, 2), (u_2, 2), (v_2, 2), (u_3, 2), (v_3, 2)$ and the vertices below those are the same but with second coordinate equal to 1. The two dashed edges are the same edge.

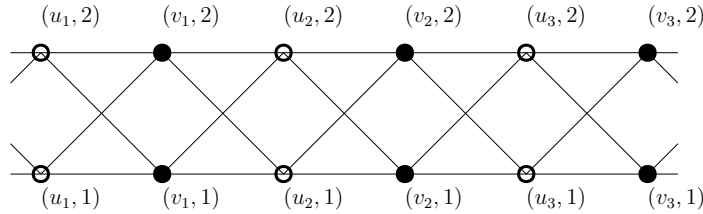

FIGURE 3. The vertices of G^\times in a loop, with all the edges of G^\times joining them.

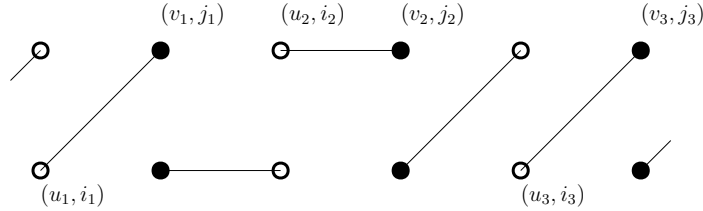

FIGURE 4. The vertices and edges of G^\times in a loop.

For an arc A in ω , label its vertices along the arc $b_A, u_1, v_1, \dots, u_k, v_k, w_A$, where u_i and w_A are all white, v_i and b_A all black (see Figure 5). Then let $r_1, s_1, \dots, r_k, s_k \in \{1, 2\}$. The dimer configuration corresponding to this list of indices is defined as in a loop, plus the two edges $\{b_A, (u_1, 3 - r_1)\}$ and $\{(v_k, 3 - s_k), w_A\}$. See Figure 6. An arc of length 1 needs no indices, as there is just one (boundary) edge in G^\times that can produce it.

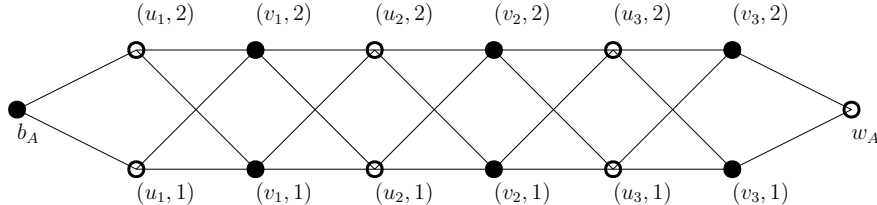
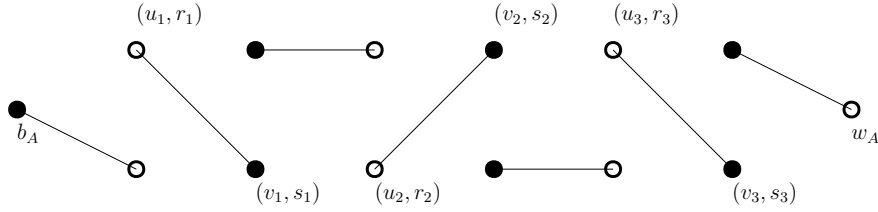

FIGURE 5. The vertices in G^\times in an arc, with all the edges of G^\times joining them.

Using this notation for a dimer configuration, we have the following lemma.

FIGURE 6. The vertices and edges in G^\times in an arc.

LEMMA 2.5. *Let m be a dimer configuration on G^\times , written as $\omega = p(m)$ and a list of indices as above for each loop, doubled edge and non-trivial arc. Then*

$$\begin{aligned} (-1)^{k(m)} &= \prod_{\text{doubled edges } e} (-1)^{i_e} \prod_{\text{cycles } C} (-1)^{1+i_1+j_1+\dots+i_k+j_k} \\ &\times \prod_{\text{non trivial arcs } A} (-1)^{r_1+s_1+\dots+r_k+s_k} (-1)^{\mathbb{1}\{b_A > w_A\}}, \end{aligned}$$

where the inequality in the final exponent is the order on the vertices of G^\times .

Proof. Let m be a dimer configuration on G^\times , and let D_m be the intersecting curves given by m as described above. The vertices of G^\times are arranged clockwise on the boundary of a disc D according to the order $<$, and each pair of vertices in an edge of m are joined by a curve in D_m . Recall $k(m)$ is the number of crossings of these curves. One can permute the pairs of bulk vertices $(v, 1), (v, 2)$ with each other in D_m and preserve $(-1)^{k(m)}$. For example, if the vertices $(v, 1), (v, 2), (u, 1), (u, 2)$ appear consecutively on the boundary of D_m , permuting them so they appear in the order $(u, 1), (u, 2), (v, 1), (v, 2)$ preserves $(-1)^{k(m)}$. We will use this property several times in the rest of the proof. The curves connecting these vertices now only cross each other and no other curve in D_m , as the vertices are consecutive.

Let $e = (u, v)$ a doubled edge in $\omega = p(m)$ with u white and b black. Using the permuting operation described above, one can permute the vertices of D_m so that the vertices of $p^{-1}(e)$ appear consecutively, in the order $(u, 1), (u, 2), (v, 1), (v, 2)$. Now the two curves in D_m corresponding to the two edges in m projecting on e do not cross the other curves, and they cross each other once if and only if $i_e = 1$, hence the contribution to $(-1)^{k_m}$ is $(-1)^{i_e}$.

Let $C = (u_1, v_1, \dots, u_k, v_k)$ be a loop in $\omega = p(m)$. Using the permuting operation described above, one can permute the vertices of D_m so that the vertices of $p^{-1}(C)$ appear consecutively, in the order: $(u_1, 1), (u_1, 2), (u_2, 1), (u_2, 2), \dots, (u_k, 1), (u_k, 2), (v_k, 1), (v_k, 2), (v_{k-1}, 1), (v_{k-1}, 2), \dots, (v_1, 1), (v_1, 2)$. See Figure 8, in which the ordering starts at $(u_1, 1)$ and proceeds clockwise. The curves connecting these vertices now only cross each other in D_m , and not other curves, as the vertices are consecutive. Write $k_{m,C}$ for the number of these crossings. We claim that

$$(-1)^{k_{m,C}} = (-1)^{1+i_1+j_1+\dots+i_k+j_k}. \quad (5)$$

Let m_0 be a dimer configuration such that on the loop C , it takes the values $i_l = j_l = 2$ for all $l = 1, \dots, k$. This configuration has no diagonal edges in C ; see Figure 7.

One sees that $(-1)^{1+i_1+j_1+\dots+i_k+j_k} = -1$ in this case. Meanwhile, the portion of D_{m_0} corresponding to C can be drawn as:

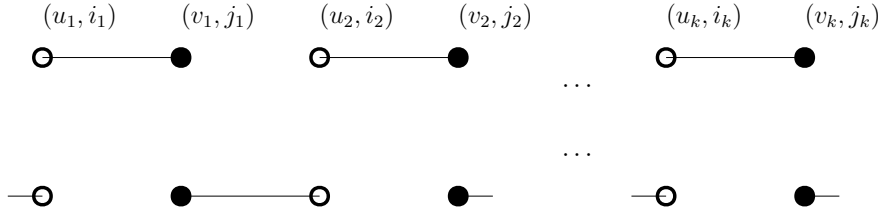
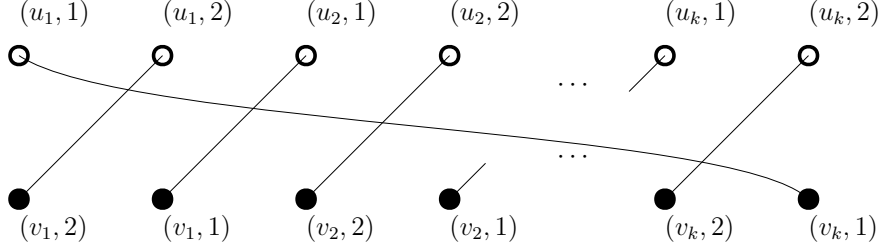
 FIGURE 7. The dimer configuration m_0 .

 FIGURE 8. The vertices and edges of m_0 arranged in some part of D_{m_0} ; the ordering of the vertices here is given by $<$.

and one can see that there are exactly $2k - 1$ crossings, hence $k_{m_0, C} = -1$, and (5) holds. Note that in Figure 8 the vertices are ordered in D_{m_0} according to $<$, whereas in Figure 7 they are arranged as in G^\times .

Now let m be some dimer configuration with some loop C in $p(m)$, and let v be some vertex in C . Let m' be the same as m , with the edges incident to $(v, 1)$, $(v, 2)$ swapped - that is, the edges $\{x, (v, 1)\}$, $\{(v, 2), y\}$ changed to $\{x, (v, 2)\}$, $\{(v, 1), y\}$. This changes the sum $i_1 + j_1 + \dots + i_k + j_k$ by exactly 1. Meanwhile, the swapping changes the number of crossings $k_{m, C}$ by exactly 1. Hence the equation (5) holds for m' if it holds for m . Inductively, (5) holds for all dimer configurations m and all loops C of m .

Let us turn now to arcs. Let m be a dimer configuration, and A an arc of $\omega = p(m)$. As with loops, we can permute the bulk (non-boundary) vertices of $p^{-1}(A)$ in the graph D_m so that they are consecutive, and in the same order as described above with a loop, without changing $(-1)^{k(m)}$. The curves between these bulk vertices in D_m can now only cross each other. The curves in D_m incident with b_A and w_A (the boundary vertices of A) may still cross the bulk curves of A (and the curves of other arcs). Assume that A is non trivial and let $k_{m, A}$ be the number of crossings in D_m between curves connecting vertices of $p^{-1}(A)$. We will show that $k_{m, A}$ satisfies

$$(-1)^{k_{m, A}} = (-1)^{r_1 + s_1 + \dots + r_k + s_k} (-1)^{\mathbb{1}\{b_A > w_A\}}. \quad (6)$$

Recall that the ordering of the boundary vertices in D_m is the order they appear on the boundary of G . Taking m_0 analogously to above, with $r_l = s_l = 2$ for all $l = 1, \dots, k$, we can draw the portion of D_{m_0} corresponding to A as:

The case drawn is the case where $w_A < b_A$, and there are $2k - 1$ crossings. In the case $w_A > b_A$, the positions of w_A and b_A are exchanged, and there is exactly one more crossing. Hence (6) holds. By the same inductive argument as used for loops above, (6) holds for all dimer configurations m and all arcs A in $\omega = p(m)$.

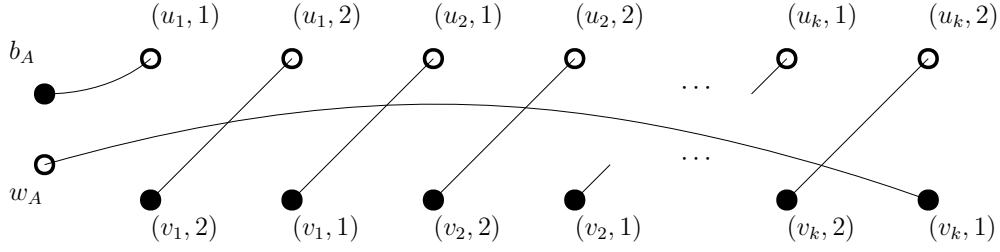

FIGURE 9

It remains to count the crossings between curves corresponding to different arcs (including trivial arcs). We claim that this number is always even. Indeed, in G , arcs are planar and non-crossing. The curves for each arc in D_m can be seen as a deformation of the actual arcs in G , obtained by identifying the bulk vertices of each arc A (using the fact that we can permute these vertices out of the way as above), and then deforming. Deforming the arcs in this way does not change $(-1)^{k(m)}$, so the number of crossings produced must be even. Taking this result, (5) and (6) together, one obtains the lemma. \square

Proof of Proposition 2.1. We have that

$$\begin{aligned}
\text{Pf}K &= \sum_m (-1)^{k(m)} \prod_{\substack{xy \in m \\ x < y}} K_{x,y} \\
&= \sum_{\omega \in \Omega} \sum_{m \in p^{-1}(\omega)} (-1)^{k(m)} \prod_{\text{doubled edges } e} \prod_{\substack{xy \in e \\ x < y}} K_{x,y} \prod_{\text{loops } C} \prod_{\substack{xy \in C \\ x < y}} K_{x,y} \prod_{\text{arcs } A} \prod_{\substack{xy \in A \\ x < y}} K_{x,y} \\
&= \sum_{\omega \in \Omega} \sum_{\text{indices}} \prod_{\text{doubled edge } e} (-1)^{i_e} \prod_{\substack{xy \in e \\ x < y}} K_{x,y} \prod_{\text{loops } C} (-1)^{1+i_1+\dots+j_k} \prod_{\substack{xy \in C \\ x < y}} K_{x,y} \\
&\quad \prod_{\text{trivial arcs } A} \prod_{\substack{xy \in A \\ x < y}} K_{x,y} \prod_{\text{non-trivial arcs } A} (-1)^{r_1+s_1+\dots+r_k+s_k+\mathbb{1}\{b_A > w_A\}} \prod_{\substack{xy \in A \\ x < y}} K_{x,y},
\end{aligned} \tag{7}$$

where the sum over “indices” is the sum over choices of indices i for doubled edges, $i_1, j_1, \dots, i_k, j_k$ for loops and $r_1, s_1, \dots, r_k, s_k$ for arcs, respectively, and the second equality uses Lemma 2.5.

First of all, for a doubled edge $e = \{u, v\}$,

$$\sum_{i_e=1,2} (-1)^{i_e} \prod_{\substack{xy \in e \\ x < y}} K_{x,y} = K_{(u,1),(v,1)} K_{(u,2),(v,2)} - K_{(u,1),(v,2)} K_{(u,2),(v,1)} = \det(\phi_e) = 1.$$

For a trivial arc $A = w_A b_A$,

$$\prod_{\substack{xy \in A \\ x < y}} K_{x,y} = (-1)^{\mathbb{1}\{w_A > b_A\}} \zeta_{w_A, b_A} \nu_{w_A, b_A} = \nu_{w_A, b_A} = 1,$$

by the assumption on the Kasteleyn phases.

Now, for a loop C , we show that

$$\sum_{i_1, j_1, \dots, i_k, j_k} (-1)^{1+i_1+\dots+j_k} \prod_{\substack{xy \in C \\ x < y}} K_{x,y} = (-1)^{\frac{|C|}{2}} \text{tr}(\phi_C), \quad (8)$$

where, recall, ϕ_C is the monodromy of the connection Φ around the loop C , and by $|C|$ we mean the number of edges in C . Recalling that in the ordering of vertices, all white vertices are before all black vertices, the product on the left hand side is

$$\begin{aligned} \prod_{\substack{xy \in C \\ x < y}} K_{x,y} &= K_{(u_1, i_1), (v_1, j_1)} K_{(u_2, 3-i_2), (v_1, 3-j_1)} K_{(u_2, i_2), (v_2, j_2)} \cdots K_{(u_k, i_k), (v_k, j_k)} K_{(u_1, 3-i_1), (v_k, 3-j_k)} \\ &= \left(\prod_{\substack{xy \in C \\ x < y}} \xi_{x,y} \right) (\phi_{u_1, v_1})_{i_1, j_1} (\phi_{u_2, v_1})_{3-i_2, 3-j_1} \cdots (\phi_{u_k, v_k})_{i_k, j_k} (\phi_{u_1, v_k})_{3-i_1, 3-j_k}. \end{aligned}$$

We now use that for matrices $\phi \in \text{SL}_2(\mathbb{C})$, $\phi_{3-i, 3-j} = (-1)^{i+j} \phi_{j, i}^{-1}$, which one can verify by hand. We replace each factor $(\phi_{u_{i+1}, v_i})_{3-i_{i+1}, 3-j_i}$ with $(-1)^{j_i+i_{i+1}} (\phi_{v_i, u_{i+1}})_{j_i, i_{i+1}}$, and the above becomes:

$$\left(\prod_{\substack{xy \in C \\ x < y}} \xi_{x,y} \right) ((-1)^{i_1+\dots+j_k}) (\phi_{u_1, v_1})_{i_1, j_1} (\phi_{v_1, u_2})_{j_1, i_2} \cdots (\phi_{u_k, v_k})_{i_k, j_k} (\phi_{v_k, u_1})_{j_k, i_1}.$$

Now the factor $(-1)^{i_1+\dots+j_k}$ in the above cancels with the same factor on the left hand side of (8), and the sum over all $i_1, j_1, \dots, i_k, j_k$ produces the trace. The product of factors ξ_e around a loop C is $(-1)^{\frac{|C|}{2}+1}$ by the Kasteleyn phases; the $+1$ in this exponent cancels with the remaining factor -1 in the left hand side of (8). Hence (8) holds.

It remains to prove the analogous formula for arcs:

$$\sum_{r_1, s_1, \dots, r_k, s_k} (-1)^{r_1+s_1+\dots+r_k+s_k+1} \mathbb{1}\{b_A > w_A\} \prod_{\substack{xy \in A \\ x < y}} K_{x,y} = (-1)^{\frac{1}{2}(|A|-1)} \psi_{w_A}^\top \phi_A \psi_{b_A}, \quad (9)$$

where by $|A|$ we mean the number of edges in A , and where, recall, ϕ_A is the product of the connection along the bulk edges of A , directed towards b_A . The proof is very similar to the loop case. We obtain:

$$\begin{aligned} \prod_{\substack{xy \in A \\ x < y}} K_{x,y} &= \left(\prod_{\substack{xy \in A \\ x < y}} \xi_{x,y} \right) (\psi_{b_A, u_1})_{3-r_1} (\phi_{u_1, v_1})_{r_1, s_1} (\phi_{u_2, v_1})_{3-r_2, 3-s_1} \\ &\quad \cdots (\phi_{u_k, v_{k-1}})_{3-r_k, 3-s_{k-1}} (\phi_{u_k, v_k})_{r_k, s_k} (\psi_{w_A, v_k})_{3-s_k} \\ &= \left(\prod_{\substack{xy \in A \\ x < y}} \xi_{x,y} \right) (-1)^{r_1+s_1+\dots+r_k+s_k} (\psi_{w_A, v_k})_{3-s_k} (\phi_{v_k, u_k})_{3-s_k, 3-r_k} (\phi_{u_k, v_{k-1}})_{3-r_k, 3-s_{k-1}} \\ &\quad \cdots (\phi_{u_2, v_1})_{3-r_2, 3-s_1} (\phi_{v_1, u_1})_{3-s_1, 3-r_1} (\psi_{b_A, u_1})_{3-r_1} \end{aligned}$$

(where in the last line we also reorder the factors for notational convenience). Similarly to the loop case, the second equality is obtained by using the formula $\phi_{u_l, v_l}(r_l, s_l) = (-1)^{r_l + s_l} \phi_{v_l, u_l}(3 - s_l, 3 - r_l)$ for each $l = k, \dots, 2$. Now the factor $(-1)^{r_1 + s_1 + \dots + r_k + s_k}$ cancels with the same appearing on the left hand side of (9), and the sum over all indices $r_1, s_1, \dots, r_k, s_k$ produces the product $\psi_{w_A}^\top \phi_A \psi_{b_A}$, where $\phi_A = \phi_{v_k, u_k} \phi_{u_k, v_{k-1}} \cdots \phi_{u_2, v_1} \phi_{v_1, u_1}$.

One then only needs that $\prod_{\substack{xy \in A \\ x < y}} \xi_{x,y} = (-1)^{\mathbb{1}\{b_A > w_A\}} (-1)^{\frac{1}{2}(|A|-1)}$. Recall that we constructed ξ to be a set of Kasteleyn phases such that $\xi_{w,b} = (-1)^{\mathbb{1}\{w > b\}}$ on boundary edges $\{w, b\}$ (apart perhaps from some edge e_0). Let C_A be the loop in G made up of an arc from w_A to b_A , and then the boundary edges from w_A to b_A (not in the direction including e_0), which we denote ∂C_A . One can show from the above that $\prod_{\substack{xy \in \partial C_A \\ x < y}} \xi_{x,y} = (-1)^{\mathbb{1}\{b_A > w_A\}} (-1)^{\frac{1}{2}(|\partial C_A|+1)}$. Then

$$\begin{aligned} \prod_{\substack{xy \in A \\ x < y}} \xi_{x,y} &= \prod_{\substack{xy \in C_A \\ x < y}} \xi_{x,y} \prod_{\substack{xy \in \partial C_A \\ x < y}} \xi_{x,y} \\ &= (-1)^{\frac{1}{2}|C_A|+1} (-1)^{\mathbb{1}\{b_A > w_A\}} (-1)^{\frac{1}{2}(|\partial C_A|+1)} \\ &= (-1)^{\mathbb{1}\{b_A > w_A\}} (-1)^{\frac{1}{2}(|A|-1)}. \end{aligned}$$

We now have both (8) and (9), which, upon substituting into 7, produces the right hand side of the Proposition 2.1, multiplied by the factor $\prod_C (-1)^{\frac{1}{2}|C|} \prod_A (-1)^{\frac{1}{2}(|A|-1)}$. This final factor disappears on seeing that $\frac{1}{2}(\sum_C |C| + \sum_A (|A| - 1))$ is half the number of vertices of $V \setminus \partial$, which we assumed to be even. \square

3. FOLDED AND SHIFTED DIMERS

3.1. Introduction of the models.

3.1.1. Temperleyan and piecewise Temperleyan approximations. We will use as much as possible the notation of [17]. Let $U \subset \mathbb{C}$ be a simply connected (bounded) set with a smooth boundary. We say that $(U_\varepsilon)_{\varepsilon > 0}$ is a sequence of graphs approximating U if the following holds:

DEFINITION 3.1 (Approximating sequence). *For every $\varepsilon > 0$, U_ε is a graph with vertex set $V(U_\varepsilon) \subset \bar{U} \cap \varepsilon\mathbb{Z}^2$ and edges connecting points at distance ε : if $u, v \in V(U_\varepsilon)$, $u \sim v$ in U_ε if and only if $u \sim v$ in $\varepsilon\mathbb{Z}^2$. For every $\varepsilon > 0$, U_ε is simply connected: if we cover every vertex of U_ε by a square of side ε centered at the vertex, we obtain a simply connected set. The vertex boundary of U_ε (i.e. the vertices of U_ε which are connected in $\varepsilon\mathbb{Z}^2$ to at least one vertex not in U_ε) is within $O(\varepsilon)$ of ∂U .*

An example is drawn on Figure 1: the vertices of the graph U_ε are the black squares enclosed by U . Its edges are not drawn, they link nearest neighbours.

From now on, let U^r be a simply connected open set with smooth boundary which is symmetric by reflection along the horizontal axis. For such symmetric sets U^r , we denote by $U = U \cap \mathbb{R} \times \mathbb{R}_{>0}$ the restriction of U^r to the strict upper half plane. Let $z \in U$ be fixed. For technical reasons, we assume that there exists $z_\partial \in \partial U^r$ and $\delta > 0$ such that the boundary

of U^r is horizontal in the neighbourhood $B(z_\partial, \delta)$. We also assume that U^r is contained in the half-plane below this flat horizontal boundary.

REMARK 3.2. *This technical hypothesis is necessary for the results of Appendices B and C to hold. It could be lightened a bit by using the comments after Lemma B.3: δ could go to zero with ε (but we must have $\varepsilon = o(\delta)$).*

Consider an approximating sequence $(U_\varepsilon^r)_{\varepsilon>0}$ of U^r which is *symmetric* by reflection along the horizontal axis and such that for every $\varepsilon > 0$ the vertex boundary of U_ε^r is horizontal in the neighbourhood $B(z_\partial, \delta)$.

Symmetric Temperleyan approximation of U^r . We define the bipartite Temperleyan domain $\mathcal{G}_\varepsilon^r$ associated with U_ε^r which has two types of black vertices: $B_1(\mathcal{G}_\varepsilon^r)$ corresponds to the vertices of U_ε^r from which we remove the rightmost vertex on the horizontal axis b_0 , and $B_0(\mathcal{G}_\varepsilon^r)$ corresponds to the inner faces of U_ε^r . The graph $\mathcal{G}_\varepsilon^r$ has two types of white vertices $W_0(\mathcal{G}_\varepsilon^r)$ corresponding to the vertical edges of U_ε^r and $W_1(\mathcal{G}_\varepsilon^r)$ corresponding to the horizontal edges of U_ε^r . There are no edges between vertices of the same colour ($\mathcal{G}_\varepsilon^r$ is bipartite), and there is an edge between $b \in B(\mathcal{G}_\varepsilon^r) = B_0(\mathcal{G}_\varepsilon^r) \cup B_1(\mathcal{G}_\varepsilon^r)$ and $w \in W(\mathcal{G}_\varepsilon^r) = W_0(\mathcal{G}_\varepsilon^r) \cup W_1(\mathcal{G}_\varepsilon^r)$ if and only if the edge w is incident to the face or vertex b in U_ε^r (see Figure 1). We also denote by B_0, B_1 the vertices and faces of $\varepsilon\mathbb{Z}^2$ and by W_0, W_1 the vertical and horizontal edges of $\varepsilon\mathbb{Z}^2$, so we can write for example $B_0(\mathcal{G}_\varepsilon^r) \subset B_0$. By Temperley's bijection [23, 18], perfect matchings of $\mathcal{G}_\varepsilon^r$ are in bijection with spanning trees of U_ε^r rooted at b_0 (see Kenyon). The sequence $(\mathcal{G}_\varepsilon^r)_{\varepsilon>0}$ is a *symmetric Temperleyan approximation* of the open set U^r . Dimer configurations of $\mathcal{G}_\varepsilon^r$ are in bijection with spanning trees of U_ε^r rooted at b_0 .

Temperleyan approximation of U . For every $\varepsilon > 0$, let U_ε be the graphs obtained by removing from U_ε^r the vertices in the strict lower half plane and the edges incident to them. The sequence $(\mathcal{G}_\varepsilon)_{\varepsilon>0} = (\mathcal{G}_\varepsilon^1)_{\varepsilon>0}$ obtained by restricting $\mathcal{G}_\varepsilon^r$ to the upper half plane (removing all vertices of $\mathcal{G}_\varepsilon^r$ in $\mathbb{R} \times \mathbb{R}_{<0}$, and the edges incident to them) is a *Temperleyan approximation* of the open set U . Dimer configurations of $\mathcal{G}_\varepsilon = \mathcal{G}_\varepsilon^1$ are in bijection with spanning trees of U_ε rooted at b_0 .

Piecewise Temperleyan approximation of U . The sequence $(\mathcal{G}_\varepsilon^2)_{\varepsilon>0}$ obtained by restricting $\mathcal{G}_\varepsilon^r$ to the *strict* upper half plane (i.e. removing all vertices of $\mathcal{G}_\varepsilon^r$ in $\mathbb{R} \times \mathbb{R}_{\leq 0}$ and the edges incident to them) is a *piecewise Temperleyan approximation* of the open set U . Indeed, it has exactly two convex white corner, v_l^* and v_r^* respectively on the left and right of the horizontal axis, see the definition in Section 5.1 of [20].

3.1.2. Loops and arcs on a Temperleyan approximation. We say that a subset of edges $\omega \subset E(\mathcal{G}_\varepsilon)$ is a loops and arcs configuration if it is made of non-intersecting loops in the bulk, arcs connecting points on the horizontal axis and doubled edges, such that every vertex of $E(\mathcal{G}_\varepsilon)$ lies on a loop, arc or doubled edge. We denote by $\Omega(\mathcal{G}_\varepsilon)$ the set of loops and arcs configurations on \mathcal{G}_ε . There are two natural ways to obtain a random loops and arcs configurations:

- Folding a random uniform dimer configuration on $\mathcal{G}_\varepsilon^r$ along the horizontal axis
- Superimposing a random uniform dimer configuration on $\mathcal{G}_\varepsilon^1$ with an independent random uniform dimer configuration on $\mathcal{G}_\varepsilon^2$

In both cases, we obtain a random loops and arcs configuration $\omega \subset E(\mathcal{G}_\varepsilon)$ of \mathcal{G}_ε (see Figure 1) which we call a *folded* or *shifted* dimer configuration. We denote by $\mu_\varepsilon^1, \mu_\varepsilon^2$ their respective probability laws on $\Omega(\mathcal{G}_\varepsilon)$ and by $\mathbb{E}_\varepsilon^1, \mathbb{E}_\varepsilon^2$ the expectation with respect to these laws.

Given $\omega \in \Omega(\mathcal{G}_\varepsilon)$, we say that an arc A of ω *encloses* a point $z \in U$ if any continuous path in U from z to z_∂ crosses the arc A . For every $\varepsilon > 0$, define two integer-valued random variables: $n_\varepsilon(z)$ is the number of arcs enclosing the fixed point $z \in U$, and $o_\varepsilon(z)$ is the indicator that there is an odd number of arcs enclosing the point z (that is the parity of $n_\varepsilon(z)$). Our main result describes the joint law of $n_\varepsilon(z)$ and $o_\varepsilon(z)$ in the scaling limit for the folded and shifted models.

3.1.3. Discrete and continuous Green's function. In this paragraph, we recall the notation and results of [17] on continuous Green's functions. Let $g : u, v \in U^r \rightarrow g(u, v) \in \mathbb{R}$ be the continuous Green's function with Dirichlet boundary conditions on U^r . Let $\tilde{g} : u, v \in U^r \rightarrow g(u, v) \in \mathbb{C}$ be the analytic function of v whose real part is the Dirichlet Green's function. Define its Wirtinger derivatives

$$\forall u, v \in U^r, \begin{cases} F_-(u, v) &= \frac{\partial \tilde{g}(u, v)}{\partial \bar{u}} \\ F_+(u, v) &= \frac{\partial \tilde{g}(u, v)}{\partial u} \end{cases}. \quad (10)$$

The holomorphic derivative F_+ is an analytic function of (u, v) while the anti-holomorphic derivative F_- is an analytic function of (\bar{u}, v) . Lemma B.3 (which adapts Theorems 13 and 14 of [15] to our setting) of the appendix gives the asymptotic of the inverse Kasteleyn matrix on $\mathcal{G}_\varepsilon^r$ in terms of F_+ and F_- , while Lemma C.1 (which adapts Theorem 6.1 of [20] to our setting) of the appendix gives the asymptotic of the inverse Kasteleyn matrix on $\mathcal{G}_\varepsilon^1$ and $\mathcal{G}_\varepsilon^2$ in terms of F_+ and F_- .

REMARK 3.3. Recall that the boundary of U^r is horizontal in the ball $B(z_\partial, \delta/2)$ and that U^r is contained in the half-plane below this horizontal boundary. Denote by s the reflection along this horizontal boundary. Since the Green's function g has Dirichlet boundary conditions, i.e. it is 0 on the boundary of U^r , the Schwarz reflection principle (see for example Section 6.5 of [1]) implies that $i\tilde{g}(u, v)$ as a function of v extends to an analytic (except at u and $s(u)$) function on $U^r \cup s(U^r)$. Hence F_+ and F_- also extend analytically (as functions of v) to this domain, in particular they are well-defined at z_∂ and they remain bounded near z_∂ (and so do their derivatives). In the proof of Lemma B.3, we will detail a discrete version of this argument developed by Kenyon in the proof of Theorem 14 of [15].

Let γ be a path from z to z_∂ , $\gamma \subset U$ except for the endpoint. Our main theorem expresses n -th moments of random variables in terms of n -fold integrals along γ of F_+ and F_- . In particular, note that F_- is an analytic function of (\bar{u}, v) , F_+ is an analytic function of (u, v) , $\overline{F_-}$ is an analytic function of (u, \bar{v}) and $\overline{F_+}$ is an analytic function of (\bar{u}, \bar{v}) . Hence, to have n -fold integrals of analytic functions along γ , for $\sigma \in \{\pm 1\}^n$, we will be looking at terms of the form

$$\int \cdots \int_\gamma \prod_{i=0}^{n-1} F_{-\sigma_i \sigma_{i+1}}^{(\sigma_i)}(\overline{z_{i+1}}, z_i) \prod_{i=0}^{n-1} dz_i^{(\sigma_i)}, \quad (11)$$

where $dz_{k_i}^{(1)} = dz_{k_i}$ and $dz_{k_i}^{(-1)} = d\overline{z_{k_i}}$, and similar for F_+ and F_- , and where the subscript $-\sigma_i \sigma_{i+1}$ should be read as \pm when $-\sigma_i \sigma_{i+1} = \pm 1$, respectively. This is well defined since the integral of an analytic function does not depend on the path.

3.2. Main result and examples. For all $n \in \mathbb{N}$, let

$$c_n(z, z_\partial) = 2i^n \sum_{\sigma \in \{\pm 1\}^n} \int \cdots \int_\gamma \prod_{i=0}^{n-1} \sigma_i F_{-\sigma_i \sigma_{i+1}}^{(\sigma_i)}(\overline{z_{i+1}}, z_i) \prod_{i=0}^{n-1} dz_i^{(\sigma_i)}.$$

For example,

$$\begin{cases} c_1(z, z_\partial) &= -4\Im \left\{ \int_\gamma F_-(\bar{z}, z) dz \right\} \\ c_2(z, z_\partial) &= 4\Re \left\{ \int \int_\gamma F_+(\bar{z}_1, z_0) \overline{F_+(\bar{z}_0, z_1)} dz_0 d\bar{z}_1 - \int \int_\gamma F_-(\bar{z}_1, z_0) F_-(\bar{z}_0, z_1) dz_0 dz_1 \right\} \end{cases} \quad (12)$$

Note that $c_n(z, z_\partial)$ is always real, since the terms in the sum corresponding to σ and $-\sigma$ are complex conjugates. Moreover, since F_+ and F_- are analytic on U and remain bounded near z_∂ , the $c_n(z, z_\partial)$ grow at most exponentially: there exists an absolute constant C (depending only on γ and U) such that

$$\forall n \in \mathbb{Z}_{\geq 0}, c_n(z, z_\partial) \leq C^n. \quad (13)$$

To state our main result, we need to introduce the *complete Bell polynomials*, defined by

$$B_n(X_1, \dots, X_n) = n! \sum_{j_1+2j_2+\dots+nj_n=n} \prod_{k=1}^n \frac{X_k^{j_k}}{(k!)^{j_k} (j_k)!}.$$

For example $B_0 = 1, B_1 = X_1, B_2 = X_1^2 + X_2$.

Recall that $n_\varepsilon(z)$ and $o_\varepsilon(z)$ are respectively the number of arcs enclosing z , and the parity of the number of arcs enclosing z .

THEOREM 3.4. *Let $\omega \in \Omega(\mathcal{G}_\varepsilon)$ be a folded or shifted dimer configuration, with law $\mu_\varepsilon = \mu_\varepsilon^1$ or $\mu_\varepsilon = \mu_\varepsilon^2$, and expectation with respect to this law denoted by \mathbb{E}_ε . For all $n \in \mathbb{Z}_{\geq 0}$, for all $\sigma \in \{0, 1\}$,*

$$\mathbb{E}_\varepsilon \left[\binom{\frac{n_\varepsilon(z) - o_\varepsilon(z)}{2}}{n} o_\varepsilon(z)^\sigma \right] \xrightarrow{\varepsilon \rightarrow 0} \frac{(-1)^{n+\sigma}}{(2n+\sigma)!} B_{2n+\sigma} \left(\left((-2)^{k-1} (k-1)! c_k(z, z_\partial) \right)_{1 \leq k \leq 2n+\sigma} \right).$$

The proof of this theorem given in Section 4. The theorem gives the following corollary:

COROLLARY 3.5. *The asymptotics of all joint moments of $(n_\varepsilon(z), o_\varepsilon(z))$ can be computed explicitly: more precisely, for all $n \in \mathbb{Z}_{\geq 0}$ and $\sigma \in \{0, 1\}$, $\mathbb{E}_\varepsilon[n_\varepsilon(z)^n o_\varepsilon(z)^\sigma]$ converges towards a polynomial in the $(c_k(z, z_\partial))_{1 \leq k \leq 2n+\sigma}$. For example,*

$$\begin{cases} \mathbb{E}_\varepsilon[o_\varepsilon(z)] & \xrightarrow{\varepsilon \rightarrow 0} -c_1(z, z_\partial) \\ \mathbb{E}_\varepsilon[n_\varepsilon(z)] & \xrightarrow{\varepsilon \rightarrow 0} 2c_2(z, z_\partial) - c_1(z, z_\partial)^2 - c_1(z, z_\partial) \\ \text{var}[n_\varepsilon(z)] & \xrightarrow{\varepsilon \rightarrow 0} -\frac{2}{3}c_1^4 - \frac{4}{3}c_1^3 - 3c_1^2 - c_1 + \frac{32}{3}c_1c_3 - 4c_2^2 + 4c_2 + \frac{16}{3}c_3 - 16c_4, \end{cases} \quad (14)$$

where in the last line we write $c_i = c_i(z, z_\partial)$ for brevity. The parity of the number of arcs enclosing a given point $o_\varepsilon(z)$ and the number of arcs surrounding a given point $n_\varepsilon(z)$ converge in law towards random variables $o(z), n(z)$ which are conformally invariant.

We explain how Theorem 3.4 implies Corollary 3.5.

Proof. We first observe that since $o_\varepsilon(z) \in \{0, 1\}$, $o_\varepsilon(z)^k = o_\varepsilon(z)$ for all $k \geq 1$, it is enough to compute $\mathbb{E}_\varepsilon[n_\varepsilon(z)^k]$ and $\mathbb{E}_\varepsilon[n_\varepsilon(z)^k o_\varepsilon(z)]$ for all $k \in \mathbb{Z}_{\geq 0}$. Theorem 3.4 applied with $n = 0, \sigma = 1$ gives

$$\mathbb{E}_\varepsilon[o_\varepsilon(z)] \xrightarrow{\varepsilon \rightarrow 0} -B_1(c_1(z, z_\partial)) = -c_1(z, z_\partial).$$

Theorem 3.4 applied with $n = 1, \sigma = 0$ gives

$$\mathbb{E}_\varepsilon[n_\varepsilon(z) - o_\varepsilon(z)] = -B_2(c_1(z, z_\partial), -2c_2(z, z_\partial)) + o_{\varepsilon \rightarrow 0}(1) = -c_1(z, z_\partial)^2 + 2c_2(z, z_\partial) + o_{\varepsilon \rightarrow 0}(1).$$

By induction, it is possible to obtain all joints moments of $(n_\varepsilon(z), o_\varepsilon(z))$ in the same way. Assume that for some n , for all $0 \leq k \leq n$ and $\sigma \in \{0, 1\}$, $\mathbb{E}_\varepsilon[n_\varepsilon(z)^k o_\varepsilon(z)^\sigma]$ is a polynomial in the $c_i(z, z_\partial)$ for $1 \leq i \leq 2k + \sigma$. Developing the binomial coefficient, we can write

$$\mathbb{E}_\varepsilon \left[\binom{\frac{n_\varepsilon(z) - o_\varepsilon(z)}{2}}{n+1} \right] = \frac{1}{2^{n+1}(n+1)!} \left(\mathbb{E}_\varepsilon[n_\varepsilon(z)^{n+1}] + \sum_{\substack{0 \leq k \leq n \\ \sigma \in \{0,1\}}} a_{k\sigma} \mathbb{E}_\varepsilon[n_\varepsilon(z)^k o_\varepsilon(z)^\sigma] \right)$$

where the $a_{k\sigma}$ are explicit coefficients. By induction, the $\mathbb{E}_\varepsilon[n_\varepsilon(z)^k o_\varepsilon(z)^\sigma]$ are explicit polynomials in the $(c_{k+\sigma}(z, z_\partial))_{1 \leq 2k+\sigma \leq 2n+1}$ (up to $o_{\varepsilon \rightarrow 0}(1)$, and by Theorem 3.4 applied at $n+1, \sigma = 0$, the left-hand side is an explicit polynomial in the $(c_{k+\sigma}(z, z_\partial))_{1 \leq 2n+2}$ (up to $o_{\varepsilon \rightarrow 0}(1)$), so $\mathbb{E}_\varepsilon[n_\varepsilon(z)^{n+1}]$ is also an explicit polynomial in the $(c_{k+\sigma}(z, z_\partial))_{1 \leq 2n+2}$ up to $o_{\varepsilon \rightarrow 0}(1)$.

Similarly, Theorem 3.4 with $n+1, \sigma = 1$ enables to express $\mathbb{E}_\varepsilon[n_\varepsilon(z)^{n+1} o_\varepsilon(z)]$ in terms of the $(c_k(z, z_\partial))_{1 \leq k \leq 2n+3}$, which concludes the induction step.

We obtained that the moments of $n_\varepsilon(z)$ converge: for all n , $\mathbb{E}_\varepsilon[n_\varepsilon(z)^n] \xrightarrow{\varepsilon \rightarrow 0} m_n$. To deduce the convergence in law of the random variable $n_\varepsilon(z)$, we only have to check the conditions of the moment problem, that is find a bound on m_n . Bounding crudely the binomial coefficient from below, we find that

$$\begin{aligned} \mathbb{E}_\varepsilon \left[\binom{\frac{n_\varepsilon(z) - o_\varepsilon(z)}{2}}{n} \right] &\geq \mathbb{E}_\varepsilon \left[\binom{\frac{n_\varepsilon(z) - 1}{2}}{n} \right] \geq \mathbb{E}_\varepsilon \left[\mathbb{1}_{n_\varepsilon(z) \geq 2n} \frac{(n_\varepsilon(z) - 2n)^n}{2^n n!} \right] \\ &\geq \mathbb{E}_\varepsilon \left[\mathbb{1}_{n_\varepsilon(z) \geq 4n} \frac{n_\varepsilon(z)^n}{4^n n!} \right] \geq \frac{1}{4^n n!} (\mathbb{E}_\varepsilon[n_\varepsilon(z)^n] - (4n)^n). \end{aligned}$$

and taking the limit in Theorem 3.4 with $n, \sigma = 0$ gives

$$m_n \leq (4n)^n + 4^n n! \frac{|B_{2n} \left(((-2)^{k-1} (k-1)! c_k(z, z_\partial))_{1 \leq k \leq 2n} \right)|}{(2n)!}.$$

Since the $c_k(z, z_\partial)$ grow at most exponentially by Equation (13), using the explicit expression of the Bell polynomial, we obtain

$$\begin{aligned} \frac{|B_{2n} \left(((-2)^{k-1} (k-1)! c_k(z, z_\partial))_{1 \leq k \leq 2n} \right)|}{(2n)!} &\leq \sum_{j_1 + 2j_2 + \dots + 2nj_{2n} = 2n} \prod_{i=1}^{2n} \frac{(2C)^k k!^{j_k}}{(k!)^{j_k} (j_k)!} \\ &= (2C)^{2n} \sum_{j_1 + 2j_2 + \dots + 2nj_{2n} = 2n} \frac{1}{(j_k)!} \\ &\leq (2C)^{2n} |\{(j_1, \dots, j_{2n}) ; j_1 + 2j_2 + \dots + 2nj_{2n} = 2n\}| \\ &\leq (2C)^{2n} \frac{(2n)^{2n}}{(2n)!}, \end{aligned}$$

since there are at most n choices for j_1 , $n/2$ choices for j_2 etc. Using Stierling's formula, we conclude that $m_n \leq C^n n^n$ for another absolute constant C , hence Carleman's condition is verified and $n_\varepsilon(z)$ converges towards a random variable $n(z)$ which is uniquely determined by its moments m_n . Since this moments are conformally invariant (they are expressed as integrals of conformal quantities), the law of $n(z)$ is also conformally invariant. \square

In the particular case $U^r = [-\infty, +\infty] \times [-\pi/2, \pi/2]$ where the Green's function has a simple explicit expression, the computations turn out to be particularly simple.

REMARK 3.6. *The infinite strip does not fill the technical hypothesis of our theorem since it is not a bounded open set, although it fills the other conditions: it is symmetric and has a horizontal boundary. Nonetheless, since the formula for the moments depends only on conformally invariant quantities, the moments can be computed in any simply connected open set, and the computations transferred to any other domain by a Riemann map. Besides, if we take $U_\varepsilon^r = \varepsilon \mathcal{Z}^2 \cap [-1/\varepsilon, 1/\varepsilon] \times [-\pi/2, \pi/2]$, the proof of Theorem 3.4 still holds, at least for the folded dimer model: the only part of the proof that has to be modified is Lemma B.3 of the Appendix. The proof of this lemma still works because, to show that $K^{-1}(b, w)$ is close to the partial derivative of the Green's function g , we only need that $g_{\mathbb{R}^2}$ (the full-plane Green's function) or $g_{\mathbb{H}}$ (the half-plane Green's function) and g are $O(\varepsilon)$ on the boundary of $\mathcal{G}_\varepsilon^r$ to apply the Harnack lemma. This is also true here.*

EXAMPLE 3.7 (The infinite strip). *Let $U^r = [-\infty, +\infty] \times [-\pi/2, \pi/2]$. We give a particularly simple expression for $\mathbb{E}_\varepsilon[o_\varepsilon(z)]$ and $\mathbb{E}_\varepsilon[n_\varepsilon(z)]$. To apply Corollary 3.5, we need to identify F_- and F_+ . The conformal map from this strip to the half plane is*

$$\phi : U^r \rightarrow \mathbb{H}, u \rightarrow \exp(u + i\pi/2) = i \exp(u).$$

On the half plane, $\tilde{g}_{\mathbb{H}}(u, v) = -\frac{1}{2\pi} \log \frac{u-v}{\bar{u}-v}$ with \log denoting the principal value of the complex logarithm (see the footnote in Section 6.3 of [17]). Hence, on the strip

$$\tilde{g}(u, v) = \tilde{g}_{\mathbb{H}}(\phi(u), \phi(v)) = -\frac{1}{2\pi} \log \left(-\frac{e^u - e^v}{e^{\bar{u}} + e^v} \right).$$

By definition, for $u, v \in U^r$,

$$F_+(u, v) = -\frac{1}{2\pi} \frac{e^u}{e^u - e^v}, \quad F_-(u, v) = \frac{1}{2\pi} \frac{e^{\bar{u}}}{e^{\bar{u}} + e^v}.$$

Let $z = x + iy$ (with $x \in (0, \pi/2)$), $z_\partial = x + i\pi/2$. For γ , we choose the vertical straight line from z to z_∂ . We first compute the probability that there is an odd number of arcs enclosing z : for all $z \in U^r$, $F_-(\bar{z}, z) = \frac{1}{4\pi}$ so

$$c_1(z, z_\partial) = -4\Im \left\{ \int_{x+iy}^{x+i\pi/2} \frac{1}{4\pi} dz \right\} = -\frac{1}{2} + \frac{y}{\pi}$$

and by Corollary 3.5,

$$\mathbb{E}_\varepsilon[o_\varepsilon(z)] \xrightarrow{\varepsilon \rightarrow 0} -c_1(z, z_\partial) = \frac{1}{2} - \frac{y}{\pi}.$$

To obtain the expected number of arcs in the limit, we first need to compute

$$c_2(z, z_\partial) = 4\Re \left\{ \int_\gamma \int_\gamma F_+(\bar{z}_1, z_0) \overline{F_+(\bar{z}_0, z_1)} dz_0 d\bar{z}_1 - \int_\gamma \int_\gamma F_-(\bar{z}_1, z_0) F_-(\bar{z}_0, z_1) dz_0 dz_1 \right\}.$$

For all $z_0 = x + iy_0$, $z_1 = x + iy_1$,

$$\begin{cases} F_-(\bar{z}_1, z_0) &= \frac{1}{2\pi} \frac{e^{z_1}}{e^{z_1} + e^{z_0}} &= \frac{1}{2\pi} \frac{e^{iy_1}}{e^{iy_1} + e^{iy_0}} &= \frac{1}{4\pi} \left(1 + i \tan \left(\frac{y_1 - y_0}{2} \right) \right) \\ F_+(\bar{z}_1, z_0) &= -\frac{1}{2\pi} \frac{e^{\bar{z}_1}}{e^{\bar{z}_1} - e^{\bar{z}_0}} &= -\frac{1}{2\pi} \frac{e^{-iy_1}}{e^{-iy_1} - e^{-iy_0}} &= -\frac{1}{4\pi} \left(1 + i \cot \left(\frac{y_1 + y_0}{2} \right) \right). \end{cases}$$

After some algebra, we get

$$c_2(z, z_\partial) = -\frac{1}{\pi^2} \ln(\sin(y)),$$

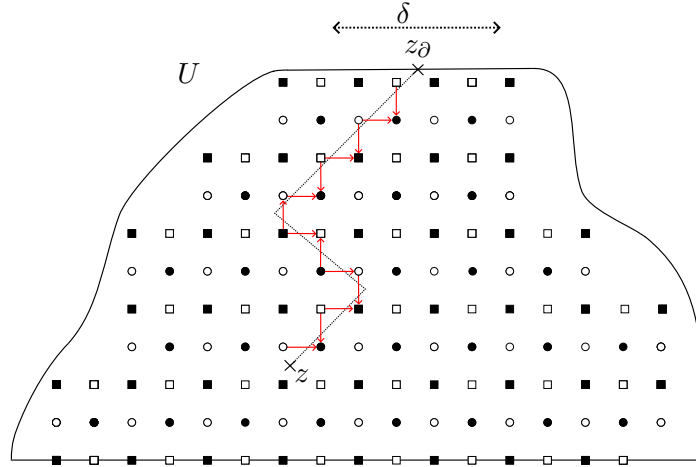

FIGURE 10. A path γ from z to z_∂ drawn as a dotted line. The associated zipper $E_\varepsilon(\gamma)$ is drawn in red (arrows indicate directed edges).

so Corollary 3.5 implies

$$\mathbb{E}_\varepsilon[n_\varepsilon(z)] \xrightarrow{\varepsilon \rightarrow 0} -\frac{2}{\pi^2} \ln(\sin(y)) + \left(\frac{1}{4} - \frac{y^2}{\pi^2}\right). \quad (15)$$

REMARK 3.8. This is coherent with what we expect of the continuous model: when z approaches the real axis, the number of arcs enclosing z explodes and it is odd or even with probability $1/2$. When z approaches the boundary of the strip, the probability that there is at least one arc enclosing z goes to 0, and so does the probability that there is an odd number of arcs. Besides, the number of arcs above a point is always positive and explodes when this point approaches the real axis.

4. PROOF OF THE MAIN THEOREM: THE FOLDED CASE.

In this section, we prove Theorem 3.4 when $\mu_\varepsilon = \mu_\varepsilon^1$, that is in the case of folded dimers. In the spirit of [17], the proof consists of choosing a connection on the graph \mathcal{G}_ε and analysing its properties.

Proof. Let γ be a path in U from z to z_∂ . The associated zipper $E_\varepsilon(\gamma)$ is the set of oriented edges of \mathcal{G}_ε crossing the path γ from left to right. An example of a zipper as a specific polygonal path is drawn in Figure 10.

Let $\varepsilon > 0$ be fixed. As in the preceding section, for every $\alpha > 0$ we can define a connection on \mathcal{G}_ε associated to the zipper by setting, for any directed edge $e \in E_\varepsilon(\gamma)$, $\phi_e = \begin{pmatrix} 1 & \alpha \\ 0 & 1 \end{pmatrix}$ and $\phi_{e^{-1}} = \phi_e^{-1}$, and $\phi_e = I_2$ on all other bulk edges. We also define $\psi_e = \begin{pmatrix} 1 \\ 1 \end{pmatrix}$ for all edges e linking a boundary point with a bulk point. Denote by K_α the Kasteleyn matrix associated with this connection and the usual Kasteleyn phases ζ of discrete holomorphy given by Equation (3). We drop the dependency in ε of the Kasteleyn matrix to lighten the notation. The Kasteleyn matrix associated with the trivial connection is $K = K_0$. By

Corollary 2.4,

$$\text{Pf}K_\alpha = \sum_{\omega \in \Omega} \prod_{\text{loops } C} \text{tr}(\phi_C) \prod_{\text{arcs } A} \psi_{b_A}^\top \phi_A \psi_{w_A}. \quad (16)$$

From here, the proof follows three main steps:

- Show that the right-hand side of Equation (16) can be expressed as a power series in α involving the moments of $n_\varepsilon(z)$ and $o_\varepsilon(z)$.
- Show that the left hand side can be expanded as a power series in α with coefficients $\text{tr}((K^{-1}S)^n)$ where K^{-1} is a discrete holomorphy matrix (see Appendix B for more details on the discrete holomorphy theory on the square lattice), and S is a matrix encoding the zipper.
- Use the asymptotic expression of K^{-1} in terms of the continuous Green's function obtained by Kenyon in [15] (see Appendix B) to show that $\text{tr}((K^{-1}S)^n)$ converges to an n -fold holomorphic integral.

First step: the right-hand side of Equation (16). Let $\alpha > 0$. Given $\omega \in \Omega(\mathcal{G}_\varepsilon)$, we denote by c_ε its total number of loops and n_ε its total number of arcs (which is constant and equal to the number of white boundary vertices). We can write:

$$\text{Pf}K = \sum_{\omega \in \Omega} 2^{c_\varepsilon} 2^{n_\varepsilon},$$

which is the partition function of the loops and arcs model. Now let $\alpha \geq 0$. The possible monodromies for loops are I_2 , $\begin{pmatrix} 1 & \alpha \\ 0 & 1 \end{pmatrix}$ and its inverse $\begin{pmatrix} 1 & -\alpha \\ 0 & 1 \end{pmatrix}$, which all have trace 2. Hence each loop contributes a factor 2 to the right-hand side of the Kasteleyn formula. For an arc A with endpoints w_A and b_A , we say that the arc is clockwise if w_A is left of b_A . By definition of the zipper $E(\gamma)$, there are three possibilities for the monodromy along an arc. If A does not enclose z , then $\phi_A = I_2$ and $\psi_{b_A}^\top \phi_A \psi_{w_A} = 2$. If A is clockwise and encloses z , since ϕ_A is computed by orienting the edges towards w_A , $\phi_A = \begin{pmatrix} 1 & \alpha \\ 0 & 1 \end{pmatrix}$ and $\psi_{b_A}^\top \phi_A \psi_{w_A} = 2 + \alpha$. If A is counterclockwise and encloses z , we get $\psi_{b_A}^\top \phi_A \psi_{w_A} = 2 - \alpha$. Given $\omega \in \Omega(\mathcal{G}_\varepsilon)$, we denote by $r_\varepsilon(z)$ (resp $l_\varepsilon(z)$) its number of clockwise (resp counterclockwise) arcs enclosing z . These quantities are random variables whose laws depends on ε . For fixed ε ,

$$\begin{aligned} \text{Pf}K_{2\alpha} &= \sum_{\omega \in \Omega} 2^{c_\varepsilon} 2^{n_\varepsilon - r_\varepsilon(z) - l_\varepsilon(z)} (2 + 2\alpha)^{r_\varepsilon(z)} (2 - 2\alpha)^{l_\varepsilon(z)} \\ &= \sum_{\omega \in \Omega} 2^{c_\varepsilon + n_\varepsilon} (1 + \alpha)^{r_\varepsilon(z)} (1 - \alpha)^{l_\varepsilon(z)}. \end{aligned} \quad (17)$$

Recall the definition of $n_\varepsilon(z)$ and $o_\varepsilon(z)$. We claim that

$$\forall \varepsilon \geq 0, \begin{cases} n_\varepsilon(z) &= l_\varepsilon(z) + r_\varepsilon(z) \\ o_\varepsilon(z) &= l_\varepsilon(z) - r_\varepsilon(z) \end{cases}.$$

The first equality is clear: an arc is either oriented clockwise or counterclockwise. We explain why the second one holds. For $\omega \in \Omega(\mathcal{G}_\varepsilon)$, the arcs enclosing z are alternating in orientation. To see this, assume that two arcs A_1 and A_2 both enclosing z have the same orientation, say clockwise $w_{A_1} < w_{A_2} < b_{A_2} < b_{A_1}$, and that there is no other arc enclosing z between them. This cannot happen because there is an odd number of boundary vertices between w_{A_1} and w_{A_2} so they cannot be matched together. For the same reason, since the leftmost corner on the boundary is black while the rightmost is white by definition of the Temperleyan domain,

there is always 0 or 1 more counterclockwise than clockwise arc which encloses z . Hence, $o_\varepsilon(z) := l_\varepsilon(z) - r_\varepsilon(z) = \mathbb{1}\{n_\varepsilon(z) \text{ is odd}\} \in \{0, 1\}$, and

$$\text{Pf}K_{2\alpha} = \sum_{\omega \in \Omega} 2^{c_\varepsilon + n_\varepsilon} (1 - \alpha^2)^{r_\varepsilon(z)} (1 - \alpha)^{o_\varepsilon(z)} = \sum_{\omega \in \Omega} 2^{c_\varepsilon + n_\varepsilon} (1 - \alpha^2)^{r_\varepsilon(z)} (1 - o_\varepsilon(z)\alpha).$$

Dividing by $\text{Pf}K$, we get

$$\begin{aligned} \frac{\text{Pf}K_{2\alpha}}{\text{Pf}K} &= \mathbb{E}_\varepsilon[(1 - \alpha^2)^{r_\varepsilon(z)} (1 - o_\varepsilon(z)\alpha)] = \mathbb{E}_\varepsilon \left[\sum_{k=0}^{\infty} (-1)^k \binom{r_\varepsilon(z)}{k} \alpha^{2k} (1 - o_\varepsilon(z)\alpha) \right] \\ &= \sum_{k=0}^{\infty} (-1)^k \alpha^{2k} \mathbb{E}_\varepsilon \left[\binom{r_\varepsilon(z)}{k} \right] - \sum_{k=0}^{\infty} (-1)^k \alpha^{2k+1} \mathbb{E}_\varepsilon \left[\binom{r_\varepsilon(z)}{k} o_\varepsilon(z) \right] \\ &= \sum_{k=0}^{\infty} (-1)^k \alpha^{2k} \mathbb{E}_\varepsilon \left[\binom{\frac{n_\varepsilon(z) - o_\varepsilon(z)}{2}}{k} \right] - \sum_{k=0}^{\infty} (-1)^k \alpha^{2k+1} \mathbb{E}_\varepsilon \left[\binom{\frac{n_\varepsilon(z) - o_\varepsilon(z)}{2}}{k} o_\varepsilon(z) \right]. \end{aligned} \quad (18)$$

For every fixed $\varepsilon > 0$ and every $\alpha > 0$ small enough, the sums converge because the number of (counterclockwise) arcs surrounding any given point is bounded.

Second step: the left-hand side of Equation (16). To lighten the notation, we write $E_\varepsilon := E_\varepsilon(\gamma)$. By definition, the zipper is a set of directed edges: we also say that an undirected edge $wb \in E(\mathcal{G}_\varepsilon)$ belongs to the zipper and we write $wb \in E_\varepsilon$ if $(w, b) \in E_\varepsilon$ or $(b, w) \in E_\varepsilon$. We also say that a (white or black) vertex $x \in \mathcal{G}_\varepsilon$ belongs to the zipper and we write $x \in E_\varepsilon$ if there exists $y \in \mathcal{G}_\varepsilon$ such that $xy \in E_\varepsilon$. If wb is an undirected edge in \mathcal{G}_ε , we define its sign by $\text{sgn}(E_\varepsilon)_{w,b} = \mathbb{1}\{(w, b) \in E_\varepsilon\} - \mathbb{1}\{(b, w) \in E_\varepsilon\}$. We write the vertices of $\mathcal{G}_\varepsilon^r$ as (x, i) with $x \in \mathcal{G}_\varepsilon$, $i \in \{1, 2\}$ where i indicates whether x is in the upper or lower half plane. We use the convention that $i = 1$ for the vertices on the horizontal axis. We note that $K_{2\alpha}$ is skew-symmetric, $(K_{2\alpha})_{(w,i),(w',j)} = (K_{2\alpha})_{(b,i),(b',j)} = 0$ for any $(w, i), (w', j) \in W(\mathcal{G}_\varepsilon^r)$ and $(b, i), (b', j) \in \mathcal{G}_\varepsilon^r$, and that for two vertices $(w, i) \in W(\mathcal{G}_\varepsilon^r)$, $(b, j) \in B(\mathcal{G}_\varepsilon^r)$,

$$\begin{aligned} (K_{2\alpha})_{(w,i),(b,j)} &= \zeta_{w,b} \mathbb{1}\{w \sim b\} (\mathbb{1}\{i = j\} + 2\alpha \mathbb{1}\{i = 2, j = 1\}) \text{sgn}(E_\varepsilon)_{w,b} \\ &= K_{(w,i),(b,j)} + 2\alpha S_{(w,i),(b,j)}, \end{aligned}$$

where

$$S_{(w,i),(b,j)} = \mathbb{1}\{w \sim b, i = 2, j = 1\} \zeta_{w,b} \text{sgn}(E_\varepsilon)_{w,b}$$

is defined by the previous equation (and S is also skew-symmetric, zero on $W(\mathcal{G}_\varepsilon^r) \times W(\mathcal{G}_\varepsilon^r)$ and on $B(\mathcal{G}_\varepsilon^r) \times B(\mathcal{G}_\varepsilon^r)$). The key observation is to interpret $K_{2\alpha} = K + 2\alpha S$ as a perturbation of the usual discrete holomorphy matrix K if we “unfold” the graph $\mathcal{G}_\varepsilon^r$ i.e. if we identify $(x, 2) \in \mathcal{G}_\varepsilon^r$ with $\bar{x} \in \varepsilon\mathbb{Z}^2$. This is almost true, but when the graph is unfolded the vertical edges on the lower half plane have the opposite orientation, see Figure 11. This is fixed by performing a gauge equivalence (on the weights this time, and not on the Kasteleyn phases as in Remark 2.3): we multiply all columns and rows by

$$\varepsilon_{(x,i)} = \begin{cases} -1 & \text{if } i = 2 \text{ and } x \in W_0 \cup B_0 \\ 1 & \text{otherwise.} \end{cases} \quad (19)$$

Hence for all $(w, i), (b, j)$,

$$\tilde{\zeta}_{(w,i),(b,j)} = \varepsilon_{(w,i)} \varepsilon_{(b,j)} \zeta_{w,b} \quad , \quad (\tilde{K}_{2\alpha})_{(w,i),(b,j)} = \varepsilon_{(w,i)} \varepsilon_{(b,j)} (K_{2\alpha})_{(w,i),(b,j)}.$$

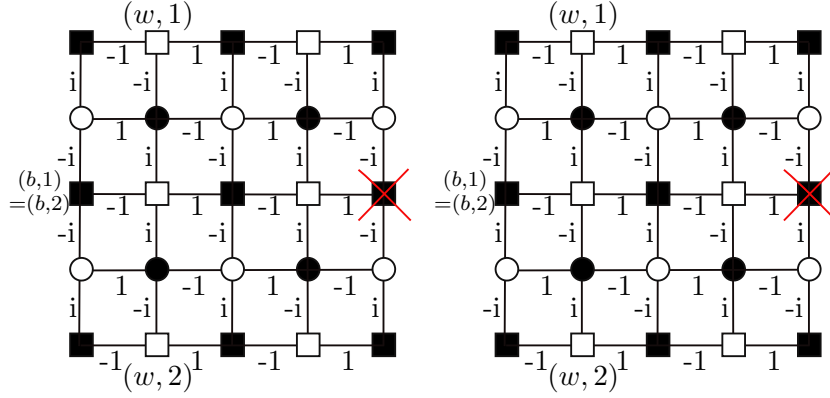

FIGURE 11. The phases ζ associated to K (on the left) and $\tilde{\zeta}$ associated to \tilde{K} (on the right). The orientations differ only for vertical edges in the lower half part of the pictures. We marked a point b on the reflection axis and a point $(w, 1)$ and its reflection $(w, 2)$ identified with the complex conjugate. The vertex crossed in red is b_0 removed by the Temperleyan boundary conditions.

The matrix \tilde{K} is the usual discrete holomorphy operator on the Temperleyan graph $\mathcal{G}_\varepsilon^r$, see Figure 11. In particular, it satisfies the asymptotic estimates of Appendix B. This depends crucially on our definition of ψ on the boundary. We have

$$(\tilde{K}_{2\alpha})_{(w,i),(b,j)} = \tilde{K}_{(w,i),(b,j)} + 2\alpha\tilde{S}_{(w,i),(b,j)} \quad (20)$$

with

$$\tilde{S}_{(w,i),(b,j)} = \mathbb{1}\{i = 2, j = 1, w \sim b\} \zeta_{w,b} \operatorname{sgn}(E_\varepsilon)_{w,b} (-1)^{w \in W_0}. \quad (21)$$

By multi-linearity of the determinant,

$$\det(\tilde{K}_\alpha) = \left(\prod_{(x,i) \in \mathcal{G}_\varepsilon^r} \varepsilon(x, i) \right)^2 \det(\tilde{K}) = \det(\tilde{K}).$$

Since the discrete holomorphy matrix \tilde{K} is invertible (see Appendix B), Equation (20) implies

$$\left(\frac{\operatorname{Pf} K_{2\alpha}}{\operatorname{Pf} K} \right)^2 = \left(\frac{\operatorname{Pf} \tilde{K}_{2\alpha}}{\operatorname{Pf} \tilde{K}} \right)^2 = \det(I + 2\alpha\tilde{S}\tilde{K}^{-1}). \quad (22)$$

By using the identity (which holds for any finite matrix M and $\alpha < \rho(M)^{-1}$ the inverse spectral radius)

$$\log(\det(I + \alpha M)) = \sum_{k=1}^{\infty} \frac{(-1)^{k-1}}{k} \alpha^k \operatorname{tr}(M^k)$$

and taking the logarithm and square root in Equation (22) (using that the Pfaffians are positive for $\alpha < 1$ due to Equation (17)), we get that

$$\forall \alpha \in (0, \rho(\tilde{S}\tilde{K}^{-1})^{-1}), \quad \frac{\operatorname{Pf} K_{2\alpha}}{\operatorname{Pf} K} = \exp \left(\frac{1}{2} \sum_{k=1}^{\infty} \frac{(-1)^{k-1}}{k} (2\alpha)^k \operatorname{tr}((\tilde{S}\tilde{K}^{-1})^k) \right). \quad (23)$$

Combining this with Equation (18), we obtain for all $\alpha \in (0, \rho(\tilde{S}\tilde{K}^{-1})^{-1})$,

$$\begin{aligned} & \sum_{k=0}^{\infty} (-1)^k \alpha^{2k} \mathbb{E}_{\varepsilon} \left[\binom{\frac{n_{\varepsilon}(z) - o_{\varepsilon}(z)}{2}}{k} \right] - \sum_{k=0}^{\infty} (-1)^k \alpha^{2k+1} \mathbb{E}_{\varepsilon} \left[\binom{\frac{n_{\varepsilon}(z) - o_{\varepsilon}(z)}{2}}{k} o_{\varepsilon}(z) \right] \\ &= \exp \left(\frac{1}{2} \sum_{k=1}^{\infty} \frac{(-1)^{k-1}}{k} (2\alpha)^k \text{tr}((\tilde{S}\tilde{K}^{-1})^k) \right). \end{aligned} \quad (24)$$

This concludes the second step of the proof: we can see from this equation that the moments of $n_{\varepsilon}(z)$ and $o_{\varepsilon}(z)$ can be computed in terms of the $\text{tr}((\tilde{S}\tilde{K}^{-1})^k)$ by algebraic manipulations (this will be detailed at the end of the proof).

Third step: the asymptotic of the trace terms. The next step of the proof is to compute $\text{tr}((\tilde{S}\tilde{K}^{-1})^n)$ for all n . Our asymptotic will imply in particular that the spectral radius $\rho(\tilde{S}\tilde{K}^{-1})$ is uniformly bounded. Let $n \geq 1$ be fixed. Using the convention that $(w_n, i_n) = (w_0, i_0)$, we can write

$$\text{tr}((\tilde{S}\tilde{K}^{-1})^n) = 2 \sum_{(w_0, i_0), \dots, (w_{n-1}, i_{n-1})} \prod_{k=0}^{n-1} (\tilde{S}\tilde{K}^{-1})_{(w_k, i_k), (w_{k+1}, i_{k+1})} \quad (25)$$

since $\tilde{S}\tilde{K}^{-1}$ is symmetric (explaining the factor 2, coming from the black vertices) and zero from black to white and white to black. The factors in the product are computed as follows: for all $u, v \in W(\mathcal{G}_{\varepsilon}^r)$, for all $i, j \in \{1, 2\}$, using Equation (21),

$$\begin{aligned} (\tilde{S}\tilde{K}^{-1})_{(u, i), (v, j)} &= \sum_{(b, k) \in B(\mathcal{G}_{\varepsilon}^r)} \tilde{S}_{(u, i), (b, k)} \tilde{K}_{(b, k), (v, j)}^{-1} \\ &= \mathbb{1}\{i = 2\} \sum_{b: \{ub\} \in E_{\varepsilon}} \zeta_{u, b} \text{sgn}(E_{\varepsilon})_{u, b} (-1)^{\mathbb{1}\{u \in W_0\}} \tilde{K}_{(b, 1), (v, j)}^{-1}. \end{aligned}$$

Developing the product in Equation (38) yields

$$\begin{aligned} \text{tr}((\tilde{S}\tilde{K}^{-1})^n) &= 2 \sum_{w_0, \dots, w_{n-1}} \sum_{\substack{b_0, \dots, b_{n-1}: \\ \{w_k b_k\} \in E_{\varepsilon}}} \prod_{k=0}^{n-1} \zeta_{w_k, b_k} \text{sgn}(E_{\varepsilon})_{w_k, b_k} (-1)^{\mathbb{1}\{w_k \in W_0\}} \tilde{K}_{(b_k, 1), (w_{k+1}, 2)}^{-1} \\ &= 2 \sum_{\substack{e_0, \dots, e_{n-1} \in E_{\varepsilon} \\ e_k = \{w_k b_k\}}} \prod_{k=0}^{n-1} \zeta_{w_k, b_k} \text{sgn}(E_{\varepsilon})_{w_k, b_k} (-1)^{\mathbb{1}\{w_k \in W_0\}} \tilde{K}_{(b_k, 1), (w_{k+1}, 2)}^{-1}. \end{aligned} \quad (26)$$

From here, the rest of the proof consists of replacing \tilde{K}^{-1} by its asymptotic expression from Lemma B.3 and identifying an n -fold Riemann sum that converges towards an n -fold holomorphic integral. Since the asymptotic expression of $\tilde{K}_{(b_k, 1), (w_{k+1}, 2)}^{-1}$ varies according to the type of w_{k+1} (W_0 or W_1) and the type of b_k (B_0 or B_1), we must split the computations into many pieces.

We choose a specific path γ in U (except for its endpoint $z_{\partial} \in \partial U$) for which the computations are tractable. More precisely, we choose γ from z to z_{∂} polygonal with slope ± 1 consisting of a finite number of line segments, and we denote by $E_{\varepsilon} = E_{\varepsilon}(\gamma)$ the associated zipper. For each line segment of γ in one of the directions NE, NW, SW, SE, the corresponding portion of the zipper $E_{\varepsilon}(\gamma)$ consists of a zig-zag path of edges, alternately horizontal and vertical. Starting from here, $C = C(U, \gamma) > 0$ is a positive constant depending only on γ and

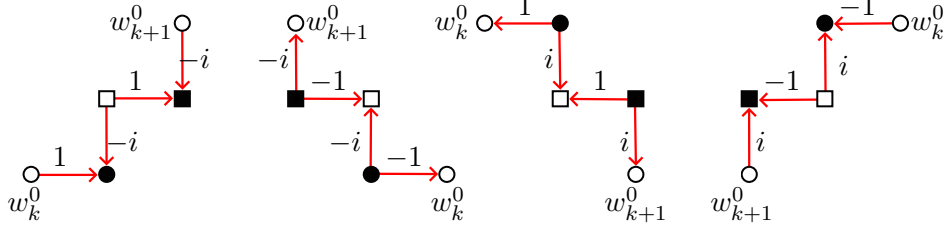

FIGURE 12. The four possible directions for a zig-zag portion of the zipper $E_\varepsilon(k)$. The Kasteleyn phases of the (undirected) edges are indicated in black.

the open set U that is allowed to change from line to line. The number of edges in the zipper is $|E_\varepsilon(\gamma)| = |\gamma|\varepsilon^{-1} + O(1) \leq C\varepsilon^{-1}$.

The edges of the zipper can be grouped in $N_\varepsilon = |\gamma|\varepsilon^{-1} + O(1) \leq C\varepsilon^{-1}$ packets of four edges (except the edges near the changes of direction of γ , of which there are $\leq C$). We have

$$E_\varepsilon = \left(\bigsqcup_{1 \leq k \leq N_\varepsilon} E_\varepsilon(k) \right) \sqcup F_\varepsilon,$$

where for $1 \leq k \leq N_\varepsilon$, the k^{th} packet $E_\varepsilon(k)$ is a zig-zag path between vertices $(w_k^0, b_k^0, w_k^1, b_k^1, w_{k+1}^0)$ with $w_k^0 \in W_0, w_k^1 \in W_1, b_k^0 \in B_0, b_k^1 \in B_1$ as in Figure 12, and where $|F_\varepsilon| \leq C$. More precisely,

$$E_\varepsilon(k) = \{w_k^0 b_k^0, b_k^0 w_k^1, w_k^1 b_k^1, b_k^1 w_{k+1}^0\}.$$

If we write for all $0 \leq k \leq N_\varepsilon$, $z_k = w_k^0$ and $dz_k = dx_k + idy_k \in \{\varepsilon(\pm 1 \pm i)\}$ the displacement of the corresponding portion of the zipper (NE, NW, SE or SW), $b_k^0 = w_k^0 + (dx_k/2, 0)$, $w_k^1 = b_k^0 + (0, dy_k/2)$, $b_k^1 = w_k^1 + (dx_k/2, 0)$, $w_{k+1}^0 = b_k^1 + (0, dy_k/2)$. Observe that $z_{k+1} = w_{k+1}^0 = z_k^0 + dz_k$ except for at most $C(\gamma)$ values of k (corresponding to the last w_k^0 before each change of direction of γ ; recall that γ is made of a finite number of straight segments) for which we still have $|z_{k+1} - z_k| \leq 2\sqrt{2}\varepsilon$.

We check the technical hypothesis of Lemma B.3. Recall that by assumption, the boundary ∂U is flat in a δ -neighbourhood of the endpoint z_∂ of γ , and that except for its endpoint γ is a path in the open set U . This implies that there exists $\delta' = \delta'(\gamma) \leq \delta$ such that for all w, b belonging to some edges of E_ε , $|b - \bar{w}| \geq \delta'/2$ and both b and \bar{w} are either in $B(z_\partial, \delta'/2)$ or at distance at least $\delta'/2$ of the boundary of U^r .

On the one hand, by Lemma B.3 and in particular the weaker consequence Equation (48), there exists $C = C(\gamma) > 0$ such that

$$\forall b, w \in E_\varepsilon, |\tilde{K}_{(b,1),(w,2)}^{-1}| \leq C\varepsilon. \quad (27)$$

On the other hand, upon increasing C we have $|F_\varepsilon| \leq C$ and $|E_\varepsilon| \leq C\varepsilon^{-1}$, so we can neglect the edges of F_ε in Equation (26) and group the remaining edges by packets:

$$\begin{aligned} \text{tr}((\tilde{S}\tilde{K}^{-1})^n) &\approx 2 \sum_{\substack{e_0, \dots, e_{n-1} \in E_\varepsilon \setminus F_\varepsilon \\ e_k = \{w_k, b_k\}}} \prod_{k=0}^{n-1} \zeta_{w_k, b_k} \text{sgn}(E_\varepsilon)_{w_k, b_k} (-1)^{\mathbb{1}\{w_k \in W_0\}} \tilde{K}_{(b_k, 1), (w_{k+1}, 2)}^{-1} \\ &\approx 2 \sum_{1 \leq k_1, \dots, k_n \leq N_\varepsilon} \sum_{\substack{e_i = \{w_i, b_i\} \in E_\varepsilon(k_i) \\ \forall 1 \leq i \leq n}} \prod_{i=0}^{n-1} \zeta_{w_i, b_i} \text{sgn}(E_\varepsilon)_{w_i, b_i} (-1)^{\mathbb{1}\{w_i \in W_0\}} \tilde{K}_{(b_i, 1), (w_{i+1}, 2)}^{-1}, \end{aligned} \quad (28)$$

where the \approx really means

$$\left| \operatorname{tr}((\tilde{S}\tilde{K}^{-1})^n) - 2 \sum_{1 \leq k_1, \dots, k_n \leq N_\varepsilon} \sum_{\substack{e_i = w_i b_i \in E_\varepsilon(k_i) \\ \forall 1 \leq i \leq n}} \prod_{i=0}^{n-1} \zeta_{w_i, b_i} \operatorname{sgn}(E_\varepsilon)_{w_i, b_i} (-1)^{\mathbb{1}\{w_i \in W_0\}} \tilde{K}_{(b_i, 1), (w_{i+1}, 2)}^{-1} \right| \leq C^{2n} \varepsilon. \quad (29)$$

From now on, we fix $1 \leq k_1, \dots, k_n \leq N_\varepsilon$ and take the corresponding term s_{k_1, \dots, k_n} in the sum on the right-hand side of Equation (28)

$$s_{k_1, \dots, k_n} = \sum_{\substack{e_i = w_i b_i \in E_\varepsilon(k_i) \\ \forall 1 \leq i \leq n}} \prod_{i=0}^{n-1} \zeta_{w_i, b_i} \operatorname{sgn}(E_\varepsilon)_{w_i, b_i} (-1)^{\mathbb{1}\{w_i \in W_0\}} \tilde{K}_{(b_i, 1), (w_{i+1}, 2)}^{-1},$$

and show that it is equal (up to an error of order $o(\varepsilon)$) to

$$\tilde{s}_{k_1, \dots, k_n} = \sum_{\sigma \in \{\pm 1\}^n} \prod_{i=0}^{n-1} i \sigma_i F_{-\sigma_i \sigma_{i+1}}^{(\sigma_i)}(\overline{z_{k_{i+1}}}, z_{k_i}) dz_{k_i}^{(\sigma_i)}.$$

Write $r_i = 1$ if $w_i \in W_0$, and $r_i = -1$ if $w_i \in W_1$, and s_i similar for b_i . Then we have, firstly: $(-1)^{\mathbb{1}\{w_i \in W_0\}} = -r_i$; secondly $\tilde{K}_{(b_i, 1), (w_{i+1}, 2)}^{-1} \leq C\varepsilon$ by Equation (27); thirdly Lemma B.3 gives us that there exists $\phi_\delta(\varepsilon) \xrightarrow{\varepsilon \rightarrow 0} 0$ such that

$$\left| \tilde{K}_{(b_i, 1), (w_{i+1}, 2)}^{-1} - \varepsilon \frac{1}{2} [F_+ + r_{i+1} F_- + s_i \overline{F_-} + r_{i+1} s_i \overline{F_+}] \right| \leq \varepsilon \phi_\delta(\varepsilon)$$

(where we omit the argument $(\overline{z_{k_{i+1}}}, z_{k_i})$ for each of the functions $F_+, F_-, \overline{F_-}, \overline{F_+}$). Actually, we could take $\phi_\delta(\varepsilon) = C(\delta)\varepsilon$ due to Lemma B.3, but we stay at a higher level of generality for further reference. Finally one can verify that

$$\zeta_{w_i, b_i} \operatorname{sgn}(E_\varepsilon)_{w_i, b_i} = \varepsilon^{-1} (-i) \left[\frac{1}{2} (1 - r_i s_i) dx_{k_i} + \frac{1}{2} (1 + r_i s_i) idy_{k_i} \right],$$

indeed, use that $\frac{1}{2} (1 - r_i s_i) = \mathbb{1}\{r_i \neq s_i\}$ and $\frac{1}{2} (1 + r_i s_i) = \mathbb{1}\{r_i = s_i\}$, and the values of $\zeta_{w_i, b_i} \operatorname{sgn}(E_\varepsilon)_{w_i, b_i}$ in Figure 12. It follows that

$$\zeta_{w_i, b_i} \operatorname{sgn}(E_\varepsilon)_{w_i, b_i} (-1)^{\mathbb{1}\{w_i \in W_0\}} = \varepsilon^{-1} \frac{1}{2} i [r_i dz_{k_i} - s_i d\overline{z_{k_i}}],$$

and so we have, up to an error $4^n C^{n-1} \varepsilon^n \phi_\delta(\varepsilon)$,

$$s_{k_1, \dots, k_n} = \sum_{r, s \in \{\pm 1\}^n} \prod_{i=0}^{n-1} \frac{1}{4} i [r_i dz_{k_i} - s_i d\overline{z_{k_i}}] [F_+ + r_{i+1} F_- + s_i \overline{F_-} + r_{i+1} s_i \overline{F_+}].$$

We multiply out this product. Recall that $dz_{k_i}^{(1)} = dz_{k_i}$ and $dz_{k_i}^{(-1)} = d\overline{z_{k_i}}$, and similar for F_+ and F_- . The above is equal to

$$\begin{aligned} & \sum_{r, s \in \{\pm 1\}^n} \sum_{\kappa, \theta \in \{0, 1\}^n} \sum_{\tau \in \{\pm 1\}^n} \prod_{i=0}^{n-1} \frac{1}{4} i \left[r_i^{1-\theta_i} (-s_i)^{\theta_i} dz_{k_i}^{((-1)^{\theta_i})} \right] \left[r_{i+1}^{\frac{1}{2}(1-\tau_i)+\kappa_i} s_i^{\kappa_i} F_{\tau_i}^{((-1)^{\kappa_i})} \right] \\ & = \sum_{\substack{r, s, \tau \in \{\pm 1\}^n \\ \kappa, \theta \in \{0, 1\}^n}} \prod_{i=0}^{n-1} \frac{1}{4} i (-1)^{\theta_i} r_i^{1-\theta_i} r_{i+1}^{\frac{1}{2}(1-\tau_i)+\kappa_i} s_i^{\theta_i+\kappa_i} F_{\tau_i}^{((-1)^{\kappa_i})} dz_{k_i}^{((-1)^{\kappa_i})}. \end{aligned}$$

If for some $i = 0, \dots, n-1$, we have $\kappa_i + \theta_i = 1$, then summing over $s_i = \pm 1$ gives zero. So the only terms that remain have $\theta_i = \kappa_i$ for all $i = 0, \dots, n-1$, and then the product is independent of s , so the above is

$$\begin{aligned} & \sum_{\substack{r, \tau \in \{\pm 1\}^n \\ \kappa \in \{0, 1\}^n}} \prod_{i=0}^{n-1} \frac{1}{2} i (-1)^{\kappa_i} r_i^{1-\kappa_i} r_{i+1}^{\frac{1}{2}(1-\tau_i)+\kappa_i} F_{\tau_i}^{((-1)^{\kappa_i})} dz_{k_i}^{((-1)^{\kappa_i})} \\ &= \sum_{\substack{r, \tau \in \{\pm 1\}^n \\ \kappa \in \{0, 1\}^n}} \prod_{i=0}^{n-1} \frac{1}{2} i (-1)^{\kappa_i} r_i^{1-\kappa_{i+1}+\kappa_i+\frac{1}{2}(1-\tau_i)} F_{\tau_i}^{((-1)^{\kappa_i})} dz_{k_i}^{((-1)^{\kappa_i})}, \end{aligned}$$

after reindexing $r_{i+1} = r_i$. Now similarly to the above, if for some $i = 0, \dots, n-1$, we have that $1 - \kappa_{i+1} + \kappa_i + \frac{1}{2}(1 - \tau_i)$ is odd, then the sum over $r_i = \pm 1$ gives zero. Hence the only terms that remain have, for all $i = 0, \dots, n-1$, that $1 - \kappa_{i+1} + \kappa_i + \frac{1}{2}(1 - \tau_i)$ is even, which is the same as $\mathbb{1}\{\kappa_i \neq \kappa_{i+1}\} = \mathbb{1}\{\tau = 1\}$, which is the same as $\tau_i = -(-1)^{\kappa_i}(-1)^{\kappa_{i+1}}$. The sum is then independent of r , and we obtain

$$s_{k_1, \dots, k_n} = \sum_{\kappa \in \{0, 1\}^n} \prod_{i=0}^{n-1} i (-1)^{\kappa_i} dz_{k_i}^{((-1)^{\kappa_i})} F_{-(-1)^{\kappa_i}(-1)^{\kappa_{i+1}}}^{((-1)^{\kappa_i})}.$$

Finally, reparameterizing as $\sigma_i = (-1)^{\kappa_i}$ gives

$$\sum_{\sigma \in \{\pm 1\}^n} \prod_{i=0}^{n-1} i \sigma_i F_{-\sigma_i \sigma_{i+1}}^{(\sigma_i)} (\overline{z_{k_{i+1}}}, z_{k_i}) dz_{k_i}^{(\sigma_i)},$$

as desired. Hence, Equation (28) becomes

$$\left| \operatorname{tr}((\tilde{S}\tilde{K}^{-1})^n) - 2 \sum_{1 \leq k_1, \dots, k_n \leq N_\varepsilon} \sum_{\sigma \in \{\pm 1\}^n} \prod_{i=0}^{n-1} i \sigma_i F_{-\sigma_i \sigma_{i+1}}^{(\sigma_i)} (\overline{z_{k_{i+1}}}, z_{k_i}) dz_{k_i}^{(\sigma_i)} \right| \leq C^m \phi_\delta(\varepsilon). \quad (30)$$

for some new constant $C > 0$. Recall that for all $1 \leq k \leq N_\varepsilon$, $z_k = w_k^0$, $|dz_k| = \sqrt{2}\varepsilon$ and $z_{k+1} = z_k + dz_k$ (except for at most C values of k for which we still have $|z_{k+1} - z_k| \leq 2\sqrt{2}\varepsilon$). We obtain the sum of 2^n (one for each $\sigma \in \{\pm 1\}^n$) n -fold Riemann sums approximating n -fold integrals along the path γ of an analytic function when $\varepsilon \rightarrow 0$. For each of these terms, the error can be bounded in terms of bounds on the derivatives of F_+ and F_- around γ (by Remark 3.3, these bounds also work near z_∂): we can find a constant C depending only on F_+, F_- and their derivatives (i.e. depending only on U and γ) such that

$$\left| 2 \sum_{1 \leq k_1, \dots, k_n \leq N_\varepsilon} s_{k_1, \dots, k_n} - c_n(z, z_\partial) \right| \leq 2^n C^m \varepsilon.$$

Upon increasing C , the triangle inequality gives

$$\left| \operatorname{tr}((\tilde{S}\tilde{K}^{-1})^n) - c_n(z, z_\partial) \right| \leq C^m \phi_\delta(\varepsilon). \quad (31)$$

for some new constant $C > 0$. We are ready to conclude: since the $c_k(z, z_\partial)$ grow at most exponentially in k (see Equation (13)), the power series

$$S_\varepsilon(\alpha) = \frac{1}{2} \sum_{k=1}^{\infty} \frac{(-1)^{k-1}}{k} (2\alpha)^k \operatorname{tr}((\tilde{S}\tilde{K}^{-1})^k)$$

has radius of convergence at least C^{-1} for some absolute constant, and Equation (31) implies that for all k ,

$$\mathrm{tr}((\tilde{S}\tilde{K}^{-1})^k) = c_k(z, z_\partial) + o(\varepsilon). \quad (32)$$

Since this power series has no constant coefficient, its exponential $\exp(S_\varepsilon(\alpha))$ is also a power series with radius of convergence at least C^{-1} . The complete Bell polynomials enable us to express the coefficients of the exponential of a power series: for all $k \geq 0$, for all power series with no constant term,

$$\exp\left(\sum_{k=1}^{\infty} a_k \frac{X^k}{k!}\right) = \sum_{n=0}^{\infty} B_n(a_1, \dots, a_n) \frac{X^n}{n!}.$$

Using Equation (32), we obtain that the n -th coefficient of the power series $\exp(S_\varepsilon(\alpha))$ is

$$\begin{aligned} [\exp(S_\varepsilon(\alpha))](n) &= \frac{1}{n!} B_n \left(\left(\frac{(-2)^{k-1} k!}{k} \mathrm{tr}((\tilde{S}\tilde{K}^{-1})^k) \right)_{1 \leq k \leq n} \right) \\ &= \frac{1}{n!} B_n \left(\left((-2)^{k-1} (k-1)! c_k(z, z_\partial) \right)_{1 \leq k \leq n} \right) + o_{\varepsilon \rightarrow 0}(1). \end{aligned}$$

This concludes by uniqueness of the coefficients in Equation (24). \square

5. LOOPS AND ARCS ON SHIFTED DOMAINS

In this section, we prove Theorem 3.4 when $\mu_\varepsilon = \mu_\varepsilon^2$, that is in the shifted case. The proof is very similar in spirit to the proof of the last section, but we have to use the estimates of the inverse Kasteleyn matrix in piecewise Temperleyan domains obtained by Russkikh in [20] (see Lemma C.3 of the Appendix) instead of those of Lemma B.3 which only work for Temperleyan domains. We follow the same steps and indicate the main changes.

Proof. As in the preceding section, let γ be a path in U from z to z_∂ and $E_\varepsilon = E_\varepsilon(\gamma)$ be the associated zipper, see Figure 10. Let $\varepsilon > 0$ be fixed. For every $\alpha \geq 0$, we define a connection on \mathcal{G}_ε by setting for any directed edge $e \in E_\varepsilon(\gamma)$, $\phi_e = \begin{pmatrix} 1 + \alpha/2 & -\alpha/2 \\ \alpha/2 & 1 - \alpha/2 \end{pmatrix}$, $\phi_{e^{-1}} = \phi_e^{-1}$, and $\phi_e = I_2$ on all other bulk edges. We also define $\psi_e = \begin{pmatrix} 1 \\ 0 \end{pmatrix}$ for all edges e linking a boundary point with a bulk point. We denote by K_α the Kasteleyn matrix associated with this connection and the Kasteleyn phases of discrete holomorphy given by Equation (3), and by $K = K_0$. Corollary 2.4 writes.

$$\mathrm{Pf}K_\alpha = \sum_{\omega \in \Omega} \prod_{\text{loops } C} \mathrm{tr}(\phi_C) \prod_{\text{arcs } A} \psi_{b_A}^\top \phi_A \psi_{w_A}. \quad (33)$$

The proof now follows the same three steps as the preceding section.

First step: the right-hand side of Equation (33). Loops get a weight 2, arcs enclosing z get a weight $1 \pm \alpha/2$ according to their orientation, so we obtain, using the same notations as in the preceding proof,

$$\mathrm{Pf}K_{2\alpha} = \sum_{\omega \in \Omega} 2^{c_\varepsilon} (1 - \alpha^2)^{r_\varepsilon(z)} (1 - o_\varepsilon(z)); \quad \mathrm{Pf}K = \sum_{\omega \in \Omega} 2^{c_\varepsilon}$$

and dividing by $\text{Pf}K$ we obtain

$$\frac{\text{Pf}K_{2\alpha}}{\text{Pf}K} = \sum_{k=0}^{\infty} (-1)^k \alpha^{2k} \mathbb{E}_{\varepsilon} \left[\binom{\frac{n_{\varepsilon}(z) - o_{\varepsilon}(z)}{2}}{k} \right] - \sum_{k=0}^{\infty} (-1)^k \alpha^{2k+1} \mathbb{E}_{\varepsilon} \left[\binom{\frac{n_{\varepsilon}(z) - o_{\varepsilon}(z)}{2}}{k} o_{\varepsilon}(z) \right] \quad (34)$$

which is exactly Equation (18), and concludes the first step of the proof.

Second step: the left-hand side of Equation (33). We use the same notations as in the preceding proof: E_{ε} for the zipper, $\text{sgn}(E_{\varepsilon})_{w,b}$ for the direction of an edge of the zipper. For $i \in \{1, 2\}$, we write the vertices of $\mathcal{G}_{\varepsilon}^i$ as (x, i) with $x \in \mathcal{G}_{\varepsilon}$ if $i = 1$, $x \in \mathcal{G}_{\varepsilon} \setminus \mathbb{R} \times \{0\}$ if $i = 2$.

Contrary to the last section, the matrix K is a *block matrix* since $\psi = \begin{pmatrix} 1 \\ 0 \end{pmatrix}$: $K_{(w,i),(b,j)} = 0$ as soon as $i \neq j$. On the $i = j = 1$ block, it is the Kasteleyn matrix on the Temperleyan domain $\mathcal{G}_{\varepsilon}^1$: it has Dirichlet boundary conditions everywhere. We write $K_{(w,1),(b,1)} = K_{w,b}^1$. On the $i = j = 2$ block, it is the Kasteleyn matrix on the *piecewise* Temperleyan domain $\mathcal{G}_{\varepsilon}^2$: it has Dirichlet boundary conditions everywhere, except on the horizontal axis where it has Neumann boundary conditions (see [20] for a general discussion of mixed boundary conditions for Kasteleyn matrices). We write $K_{(w,2),(b,2)} = K_{w,b}^2$. The asymptotic of $(K^1)^{-1}$ and $(K^2)^{-1}$ when $\varepsilon \rightarrow 0$ were obtained in [20] and are recalled in Lemma C.3. Note that contrary to the last section, the vertical orientation is correct for K^1 and K^2 , hence we do not need any gauge change. We can write

$$(K_{2\alpha})_{(w,i),(b,j)} = K_{(w,i),(b,j)} + \alpha S_{(w,i),(b,j)}$$

with

$$S_{(w,i),(b,j)} = \mathbb{1}\{w \sim b\} \zeta_{w,b} \text{sgn}(E_{\varepsilon})_{w,b} (-1)^{i-1}. \quad (35)$$

In other words, $K_{2\alpha} = K + \alpha S$ and as in the preceding section Equation (34) becomes, for all $\alpha \in (0, \rho(SK^{-1})^{-1})$,

$$\begin{aligned} & \sum_{k=0}^{\infty} (-1)^k \alpha^{2k} \mathbb{E}_{\varepsilon} \left[\binom{\frac{n_{\varepsilon}(z) - o_{\varepsilon}(z)}{2}}{k} \right] - \sum_{k=0}^{\infty} (-1)^k \alpha^{2k+1} \mathbb{E}_{\varepsilon} \left[\binom{\frac{n_{\varepsilon}(z) - o_{\varepsilon}(z)}{2}}{k} o_{\varepsilon}(z) \right] \\ &= \exp \left(\frac{1}{2} \sum_{k=1}^{\infty} \frac{(-1)^{k-1}}{k} \alpha^k \text{tr}((SK^{-1})^k) \right), \end{aligned} \quad (36)$$

which concludes the second step.

Third step: the asymptotic of the trace term. We only need to prove, as in the preceding section (up to a factor 2^n) that

$$\left| \text{tr}((SK^{-1})^n) - 2^{n+1} \sum_{1 \leq k_1, \dots, k_n \leq N_{\varepsilon}} \sum_{\sigma \in \{\pm 1\}^n} \prod_{i=0}^{n-1} i \sigma_i F_{-\sigma_i \sigma_{i+1}}^{(\sigma_i)}(\overline{z_{k_{i+1}}}, z_{k_i}) dz_{k_i}^{(\sigma_i)} \right| \leq C^n \phi_{\delta}(\varepsilon). \quad (37)$$

for some $C = C(\gamma) > 0$, $\phi_{\delta}(\varepsilon) \xrightarrow{\varepsilon \rightarrow 0} 0$. Indeed, if this holds, the proof of the last section carries through. We prove it using the same general strategy as in the third step of the last section. Let $n \geq 1$ be fixed. Using the convention that $(w_n, j_n) = (w_0, j_0)$, we can write

$$\text{tr}((SK^{-1})^n) = 2 \sum_{(w_0, j_0), \dots, (w_{n-1}, j_{n-1})} \prod_{k=0}^{n-1} (SK^{-1})_{(w_k, j_k), (w_{k+1}, j_{k+1})}. \quad (38)$$

The factors in the product are computed as follows: for all $u, v \in W(\mathcal{G}_\varepsilon^r)$, for all $i, j \in \{1, 2\}$, using Equation (35), and the fact that $K_{(w,i),(b,j)}^{-1}$ vanishes when $i \neq j$,

$$(SK^{-1})_{(u,i),(v,j)} = \sum_{(b,k) \in B(\mathcal{G}_\varepsilon^r)} S_{(u,i),(b,k)} K_{(b,k),(v,j)}^{-1} = (-1)^{i-1} \sum_{b: \{ub\} \in E_\varepsilon} \zeta_{u,b} \text{sgn}(E_\varepsilon)_{u,b} (K^j)_{b,v}^{-1}.$$

Developing the product in Equation (38) yields

$$\text{tr}((SK^{-1})^n) = 2 \sum_{j_0, \dots, j_{n-1} \in \{1, 2\}} \sum_{\substack{e_0, \dots, e_{n-1} \in E_\varepsilon \\ e_k = \{w_k b_k\}}} \prod_{k=0}^{n-1} \zeta_{w_k, b_k} \text{sgn}(E_\varepsilon)_{w_k, b_k} (-1)^{j_k} (K^{j_{k+1}})_{b_k, w_{k+1}}^{-1} \quad (39)$$

(note that we also reindexed $j_{k+1} = j_k$). We choose the same path γ in U as in the preceding section and we group the edges by packets as before, see Figure 12 and the corresponding paragraph. We use the same notation:

$$E_\varepsilon = \left(\bigsqcup_{1 \leq k \leq N_\varepsilon} E_\varepsilon(k) \right) \sqcup F_\varepsilon.$$

Here we need to be more careful than in the last section when neglecting the edges in F_ε , since the terms are no more $O(\varepsilon)$ when w_{k+1} and b_k are getting close. By Lemma C.3 and in particular the weaker consequence Equation (51),

$$|(K^{j_{k+1}})_{b_k, w_{k+1}}^{-1} - \Delta(w_{k+1}, b_k)| \leq C\varepsilon$$

for some constant $C = C(\delta)$. In Equation (39), the error $\Delta(w_{k+1}, b_k)$ cancels between the terms $j_k = \pm 1$, so we can rewrite it as

$$2 \sum_{j_0, \dots, j_{n-1} \in \{1, 2\}} \sum_{\substack{e_0, \dots, e_{n-1} \in E_\varepsilon \\ e_k = \{w_k b_k\}}} \prod_{k=0}^{n-1} \zeta_{w_k, b_k} \text{sgn}(E_\varepsilon)_{w_k, b_k} (-1)^{j_k} \left((K^{j_{k+1}})_{b_k, w_{k+1}}^{-1} - \Delta(w_{k+1}, b_k) \right).$$

Now, we can neglect the edges in F_ε : since $|F_\varepsilon| \leq C$ (upon increasing C), it holds that up to $C^n \varepsilon$ (upon increasing C again),

$$\text{tr}((SK^{-1})^n) = 2 \sum_{1 \leq k_1, \dots, k_n \leq N_\varepsilon} \sum_{\substack{j_i \in \{1, 2\} \\ \forall 1 \leq i \leq n}} \sum_{\substack{e_i = w_i b_i \in E_\varepsilon(k_i) \\ \forall 1 \leq i \leq n}} \prod_{i=0}^{n-1} \left\{ \zeta_{w_i, b_i} \text{sgn}(E_\varepsilon)_{w_i, b_i} (-1)^{j_i-1} \right. \\ \left. \times \left((K^{j_{i+1}})_{b_i, w_{i+1}}^{-1} - \Delta(w_{i+1}, b_i) \right) \right\}. \quad (40)$$

From now on, we fix $1 \leq k_1, \dots, k_n \leq N_\varepsilon$ and take the corresponding term s_{k_1, \dots, k_n} in the sum on the right-hand side of Equation (40):

$$s_{k_1, \dots, k_n} = \sum_{j_i \in \{1, 2\}} \sum_{e_i = w_i b_i \in E_\varepsilon(k_i)} \prod_{i=0}^{n-1} \zeta_{w_i, b_i} \text{sgn}(E_\varepsilon)_{w_i, b_i} (-1)^{j_i-1} \left((K^{j_{i+1}})_{b_i, w_{i+1}}^{-1} - \Delta(w_{i+1}, b_i) \right).$$

Recall that w_i, b_i are within distance $2\sqrt{2}\varepsilon$ of z_{k_i} . We show that (up to an error of order $o(\varepsilon)$)

$$s_{k_1, \dots, k_n} = 2^n \sum_{\sigma \in \{\pm 1\}^n} \prod_{i=0}^{n-1} i \sigma_i F_{-\sigma_i \sigma_{i+1}}^{(\sigma_i)}(\overline{z_{k_{i+1}}}, z_{k_i}) dz_{k_i}^{(\sigma_i)}.$$

Note that in this expression, F_{\pm} are the functions defined in Equation (47) and appearing in Lemma B.3, and $F_{\pm}^{(\sigma)}$ for $\sigma = \pm 1$ denotes complex conjugation (in particular $F_{\pm}^{(\sigma)}$ is *not* the F_{\pm}^j , $j \in \{1, 2\}$ appearing in Lemma C.3, though they are related as we will see).

Let $r_i, s_i \in \{\pm 1\}$ be such that $w_i \in W_{\frac{1-r_i}{2}}$, $b_i \in B_{\frac{1-s_i}{2}}$. By Lemma C.3,

$$(K^{j_{i+1}})_{b_i, w_{i+1}}^{-1} - \Delta(w_{i+1}, b_i) = \frac{\varepsilon}{2} \left[\overline{F_+^{j_{i+1}}(z_{k_{i+1}}, z_{k_i}) + r_{i+1} F_-^{j_{i+1}}(z_{k_{i+1}}, z_{k_i})} + s_i \overline{F_-^{j_{i+1}}(z_{k_{i+1}}, z_{k_i}) + r_{i+1} s_i F_+^{j_{i+1}}(z_{k_{i+1}}, z_{k_i})} \right] + \varepsilon \phi_{\delta}(\varepsilon).$$

where $\phi_{\delta}(\varepsilon) \xrightarrow{\varepsilon \rightarrow 0} 0$. We will omit the argument $(z_{k_{i+1}}, z_{k_i})$ and the dependence in j_{i+1} for each of the functions $F_+, F_-, \overline{F_-}, \overline{F_+}$. Recall that this implies (see Equation (51)) that

$$|(K^{j_{i+1}})_{b_i, w_{i+1}}^{-1} - \Delta(w_{i+1}, b_i)| \leq C(\delta)\varepsilon.$$

Moreover, one can verify that

$$\zeta_{w_i, b_i} \operatorname{sgn}(E_{\varepsilon})_{w_i, b_i} = -r_i \frac{\varepsilon^{-1}}{2} i [r_i dz_{k_i} - s_i d\overline{z_{k_i}}],$$

and so we have, up to an error $C^n \varepsilon \phi_{\delta}(\varepsilon)$ (upon increasing C),

$$s_{k_1, \dots, k_n} = \sum_{r, s \in \{\pm 1\}^n, j_i \in \{1, 2\}} \prod_{i=0}^{n-1} \frac{r_i (-1)^{j_i}}{4} i [r_i dz_{k_i} - s_i d\overline{z_{k_i}}] [F_+ + r_{i+1} F_- + s_i \overline{F_-} + r_{i+1} s_i \overline{F_+}].$$

We multiply out this product. Recall that $dz_{k_i}^{(1)} = dz_{k_i}$ and $dz_{k_i}^{(-1)} = d\overline{z_{k_i}}$, and similar for F_+ and F_- . The above is equal to

$$\sum_{j_i \in \{1, 2\}} \sum_{r, s, \tau \in \{\pm 1\}^n} \prod_{\kappa, \theta \in \{0, 1\}^n} \frac{(-1)^{j_i r_i}}{4} i (-1)^{\theta_i} r_i^{1-\theta_i} r_{i+1}^{\frac{1}{2}(1-\tau_i) + \kappa_i} s_i^{\theta_i + \kappa_i} F_{\tau_i}^{((-1)^{\kappa_i})} dz_{k_i}^{((-1)^{\theta_i})}.$$

If for some $i = 0, \dots, n-1$, we have $\kappa_i + \theta_i = 1$, then summing over $s_i = \pm 1$ gives zero. So the only terms that remain have $\theta_i = \kappa_i$ for all $i = 0, \dots, n-1$, and then the product is independent of s , so the above is

$$\sum_{j_i \in \{1, 2\}} \sum_{r, \tau \in \{\pm 1\}^n} \prod_{\kappa \in \{0, 1\}^n} \frac{(-1)^{j_i r_i}}{2} i (-1)^{\kappa_i} r_i^{1-\kappa_{i+1} + \kappa_i + \frac{1}{2}(1-\tau_i)} F_{\tau_i}^{((-1)^{\kappa_i})} dz_{k_i}^{((-1)^{\kappa_i})},$$

after reindexing $r_{i+1} = r_i$. Now similarly to the above, if for some $i = 0, \dots, n-1$, we have that $1 - \kappa_{i+1} + \kappa_i + \frac{1}{2}(1 - \tau_i)$ is *even* (contrary to the last section), then the sum over $r_i = \pm 1$ gives zero. Hence the only terms that remain have for all $i = 0, \dots, n-1$ that $1 - \kappa_{i+1} + \kappa_i + \frac{1}{2}(1 - \tau_i)$ is odd, which is the same as $\mathbb{1}\{\kappa_i \neq \kappa_{i+1}\} \neq \mathbb{1}\{\tau = 1\}$, which is the same as $\tau_i = (-1)^{\kappa_i} (-1)^{\kappa_{i+1}}$. The sum is then independent of r , and we obtain

$$s_{k_1, \dots, k_n} = \sum_{j_i \in \{1, 2\}} \sum_{\kappa \in \{0, 1\}^n} \prod_{i=0}^{n-1} (-1)^{j_i} i (-1)^{\kappa_i} dz_{k_i}^{((-1)^{\kappa_i})} F_{(-1)^{\kappa_i} (-1)^{\kappa_{i+1}}}^{((-1)^{\kappa_i})}.$$

Finally, reparameterizing as $\sigma_i = (-1)^{\kappa_i}$ gives

$$\sum_{j_i \in \{1, 2\}} \sum_{\sigma \in \{\pm 1\}^n} \prod_{i=0}^{n-1} (-1)^{j_i} i \sigma_i F_{\sigma_i \sigma_{i+1}}^{(\sigma_i)} dz_{k_i}^{(\sigma_i)},$$

The last step of the argument is specific to the shifted case. It is time to recall the dependence of the i -th term in $j_{i+1}, z_{k_i}, \overline{z_{k_{i+1}}}$ which was hidden in the notation for a while. For $j \in \{1, 2\}$, $\sigma \in \{\pm 1\}$, $(F_{\pm}^j)^{(\sigma)}$ is $(F_{\pm}^1)^{(\sigma)}$ if $j = 1$, $(F_{\pm}^2)^{(\sigma)}$ if $j = 2$ (recall that the exponent (σ) denotes complex conjugation). Using the explicit expression for F_{\pm}^1 and F_{\pm}^2 (defined on U) in terms of F_{\pm} (defined on U^r), see Equation (52) of Appendix C, s_{k_1, \dots, k_n} can be written as

$$\sum_{j_i \in \{1, 2\}, \sigma \in \{\pm 1\}^n} \prod_{i=0}^{n-1} (-1)^{j_i} i \sigma_i \left[F_{\sigma_i \sigma_{i+1}}^{(\sigma_i)}(z_1, z_2) + (-1)^{j_{i+1}} F_{-\sigma_i \sigma_{i+1}}^{(\sigma_i)}(z_1, \overline{z_2}) \right] dz_{k_i}^{(\sigma_i)}.$$

Developing the product yields

$$\sum_{j_i \in \{1, 2\}, \sigma \in \{\pm 1\}^n, \kappa \in \{\pm 1\}^n} \prod_{i=0}^{n-1} (-1)^{j_i} i \sigma_i (-1)^{\frac{\kappa_i - 1}{2} j_{i+1}} F_{\kappa_i \sigma_i \sigma_{i+1}}^{(\sigma_i)}(z_1, z_2^{(\kappa_i)}) dz_{k_i}^{(\sigma_i)}.$$

If for some $i = 0, \dots, n-1$ we have $\kappa_i = 1$, then summing over $j_{i+1} = \pm 1$ gives zero, so the only terms remaining have $\kappa_i = -1$ for all i and then the product is independent of κ , so the above is

$$\sum_{j_i \in \{1, 2\}, \sigma \in \{\pm 1\}^n} \prod_{i=0}^{n-1} i \sigma_i F_{-\sigma_i \sigma_{i+1}}^{(\sigma_i)}(z_1, \overline{z_2}) dz_{k_i}^{(\sigma_i)} = 2^n \sum_{\sigma \in \{\pm 1\}^n} \prod_{i=0}^{n-1} i \sigma_i F_{-\sigma_i \sigma_{i+1}}^{(\sigma_i)}(z_1, \overline{z_2}) dz_{k_i}^{(\sigma_i)}$$

which concludes the proof. \square

6. THE CASE OF A RECTANGLE: COMPUTING THE NUMBER OF ARCS CROSSING IN THE VERTICAL DIRECTION

In this section, we consider a slightly different setting (strongly inspired by section 9 of [17]) and show that in some cases we can compute new interesting quantities by diagonalizing the Kasteleyn matrix. Let G be the subgraph of \mathbb{Z}^2 with vertex set $[0, n] \times [1, m]$. We define its boundary to be $\partial = \{0, n\} \times [1, m]$. We define a graph \mathcal{G}^r by taking two copies of G with vertices labeled as $(x, y, 1)$ and $(x, y, 2)$ for $(x, y) \in G$ and by identifying $(x, y, 1) = (x, y, 2)$ for $(x, y) \in \partial G$. In other words, \mathcal{G}^r is the cylinder $\mathbb{Z}/(2n\mathbb{Z}) \times [1, m]$ if we identify $(x, y, 1) = (x, y)$ and $(x, y, 2) = (-x, y)$, with the slight abuse of notation that we identify $x \in \mathbb{Z}$ with its projection $\bar{x} \in \mathbb{Z}/(2n\mathbb{Z})$ so that in particular, for all y , $(n, y, 1) = (n, y) = (-n, y) = (n, y, 2)$. A uniformly random dimer configuration on \mathcal{G}^r gives a random configuration of disjoint loops, doubled edges and arcs, obtained by superimposing the two layers. Arcs link two boundary vertices that can be on the same side or on opposite sides of the cylinder.

REMARK 6.1. *Note that it is an example where ∂ has two connected components. It complements the strip Example 3.7 where it has one connected component.*

The arcs always have one black and one white endpoint since the vertices along the boundary (blue bullets and circles on Figure 13) are alternating in colour. We define the random variable $N_{n,m}$ to be the number of arcs traversing from one vertical boundary to the other.

THEOREM 6.2. *Let $\tau > 0$ be fixed, $q = e^{-\pi\tau}$. When $n, m \rightarrow \infty$ with their ratio $\frac{n}{m} \rightarrow \tau$, the characteristic function of $N_{m,n}$ converges to an explicit limit*

$$\sum_k \mathbb{P}[N_{m,n} = k] Y^k \xrightarrow{n \rightarrow \infty} \prod_{\substack{j=1 \\ j \text{ odd}}}^{\infty} \frac{1 + q^{2j} - 2q^j + 4Y^2 q^j}{1 + q^{2j} + 2q^j}.$$

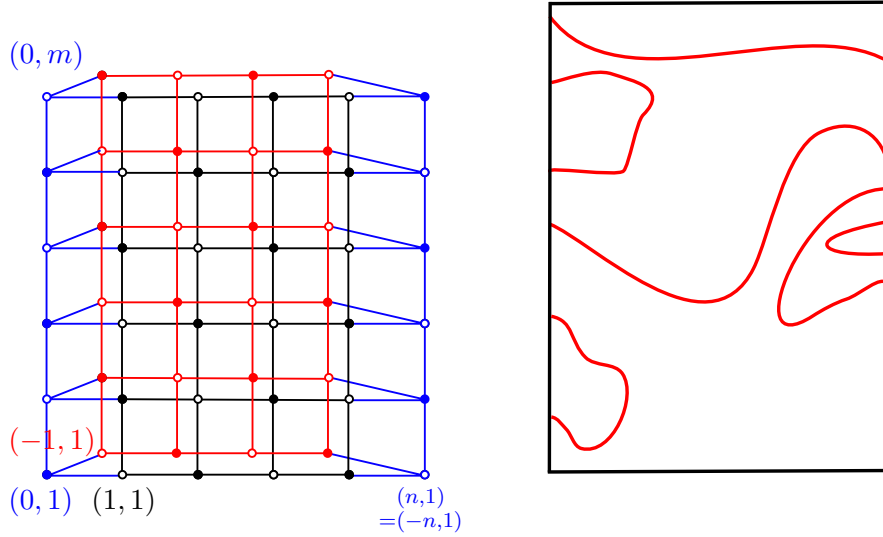

FIGURE 13. The graph \mathcal{G}^r on the left, with $(x, y, 1)$ in black, $(x, y, 2)$ in red and the boundary vertices in blue. On the right, a loops and arc configuration, with some of the arcs drawn in red (the loops are not drawn) and with $N_{n,m} = 2$.

Proof. We choose complex Kasteleyn phases ζ by putting $\zeta = 1$ on all horizontal edges and $\zeta = i$ on all vertical edges. These complex Kasteleyn phases can be obtained by a gauge transform from the ones of Figure 2, so Proposition 2 holds with the complex phases ζ by Remark 2.3. Then, for any choice of connection ϕ on G , if K_ϕ is the Kasteleyn matrix associated to the connection ϕ and the phases ζ , Proposition 2.1 holds. We now turn to the choice of the connection. Let $\rho \in \mathbb{C}$ be fixed and $a \in \mathbb{C}$ such that $a^n = \rho$. We can define a connection on the bulk by setting, for any horizontal bulk edge e (pointing right), $\phi_e = \begin{pmatrix} a & 0 \\ 0 & \frac{1}{a} \end{pmatrix}$ and $\phi_{-e} = \phi_e^{-1}$. For any vertical bulk edge, we define $\phi_e = I_2$. We also define $\psi_e = \begin{pmatrix} a \\ \frac{1}{a} \end{pmatrix}$ for all (horizontal) edges e pointing right linking a boundary point with a bulk point and $\psi_e = \begin{pmatrix} \frac{1}{a} \\ a \end{pmatrix}$ for all (horizontal) edges e linking a boundary point with a bulk point pointing left. Denote by K_a the Kasteleyn matrix associated with this choice of connection and orientation as in the preceding section and $K = K_1$ the Kasteleyn matrix associated with the trivial connection. We can now analyse the formula of Proposition 2.1. The loops have monodromy I_2 so they get a weight 2, and the arcs that come back to the same boundary also get a weight 2, while the arcs that go from one side to the other get a weight $\psi_{b_A}^\top \phi_A \psi_{w_A} = a^n + a^{-n} = \rho + \rho^{-1}$. Hence,

$$\text{Pf}K_a = \sum_{\omega \in \Omega} 2^{\#\text{loops}} 2^{\#\text{arcs}} \left(\frac{\rho + \rho^{-1}}{2} \right)^{\#\text{arcs traversing}},$$

so

$$\frac{\text{Pf}K_a}{\text{Pf}K} = \sum_{k \in \mathbb{N}} \mathbb{P}[N_{m,n} = k] \left(\frac{\rho + \rho^{-1}}{2} \right)^k. \quad (41)$$

We are left with computing the left-hand side, or rather its square $\frac{\det(K_a)}{\det K}$. We define the matrix \bar{K}_a by $\bar{K}_a(w, b) = K_a(w, b)$ for all b black and w white in \mathcal{G}^r : it is the symmetric version of K_a (which is by definition antisymmetric). Using the block structure of K_a and \bar{K}_a , we get $\det(\bar{K}_a) = -\det(K_a)$ so the ratio of determinants is left unchanged. We now observe that the matrix \bar{K}_a that we have constructed is exactly that of Kenyon. Writing $\lambda = \rho^2$ (which satisfies $a^{2n} = \lambda$, $X = \rho^2 + \frac{1}{\rho^2}$), and since K corresponds to $a = 1$ and $X = 2$, if m is even, the results of Section 9 of Kenyon (conformal invariance of domino tiling) imply

$$\frac{\det(K_a)}{\det(K)} = \frac{\det(\bar{K}_a)}{\det(\bar{K})} \xrightarrow[\frac{n}{m} \rightarrow \tau]{n \rightarrow \infty} \prod_{\substack{j=1 \\ j \text{ odd}}}^{\infty} \frac{(1 + q^{2j} + Xq^j)^2}{(1 + q^j + q^{2j})^2}.$$

Combining this with Equation 41 gives

$$\left(\sum_k \mathbb{P}[N_{m,n} = k] \left(\frac{\rho + \rho^{-1}}{2} \right)^k \right)^2 \xrightarrow[\frac{n}{m} \rightarrow \tau]{n \rightarrow \infty} \prod_{\substack{j=1 \\ j \text{ odd}}}^{\infty} \frac{(1 + q^{2j} + Xq^j)^2}{(1 + q^j + q^{2j})^2}.$$

For $\rho \in \mathbb{C}$, such that $Y = \frac{\rho + \frac{1}{\rho}}{2} > 0$, $Y^2 = \frac{X+2}{4}$ so $X > -2$ and all (squared) factors on both sides are non-negative so we can take the square root:

$$\sum_k \mathbb{P}[N_{m,n} = k] Y^k \xrightarrow[\frac{n}{m} \rightarrow \tau]{n \rightarrow \infty} \prod_{\substack{j=1 \\ j \text{ odd}}}^{\infty} \frac{1 + q^{2j} + Xq^j}{1 + q^j + q^{2j}} = \prod_{\substack{j=1 \\ j \text{ odd}}}^{\infty} \frac{1 - 2q^j + q^{2j} + 4Y^2 q^j}{1 + q^j + q^{2j}}.$$

□

APPENDIX A. COMPUTATION IN THE CONTINUUM (BY AVELIO SEPÚLVEDA)

The objective of this section is to compute the expected values of the random variables $n(z)$ and $o(z)$ for the ALE. These random variables are clearly conformally invariant, as the ALE itself is. More precisely we plan to show the following.

PROPOSITION A.1. *Let \mathcal{A} be an ALE in the strip $\mathbb{R} \times [0, \pi/2]$, $n(z)$ the amount of arcs of \mathcal{A} that separate the upper boundary from z and $O(z) = (-1)^{n(z)}$. We have that*

$$\begin{aligned} \mathbb{E}[n(z)] &= \frac{1}{4} - \frac{(\Im(z))^2}{\pi^2} - \frac{2}{\pi^2} \log(\sin(\Im(z))) \\ \mathbb{P}[O(z) = -1] &= 1/2 - \Im(z)/\pi. \end{aligned}$$

Note importantly that these moments exactly coincide with Example 3.7.

Before showing the proposition, let us define the strips $S^+ = \mathbb{R} \times [0, \pi/2]$ and $\check{S} = \mathbb{R} \times [-\pi/2, \pi/2]$. Note that the conformal radius of these strips is given by

$$\begin{aligned} CR(z, \check{S}) &= 2 \cos(\Im(z)), \\ CR(z, S^+) &= \sin(2\Im(z)) = 2 \sin(\Im(z)) \cos(\Im(z)). \end{aligned}$$

In what follows $\lambda = \sqrt{\pi/8}$. Let $D \subseteq \mathbb{H}$ be a domain with $\partial D = \partial_1 \cup \partial_2$, $\partial_1 \cap \partial_2 = \emptyset$ and ∂_2 an interval of \mathbb{R} . We also define \check{D} to be the domain obtained by reflecting D on \mathbb{H} . We

take Φ to be a GFF in a domain D with boundary condition λ on ∂_1 and 0 on ∂_2 , and $\check{\Phi}$ be a GFF in D with boundary condition 0 on ∂_1 and free on ∂_2 . We couple Φ and $\check{\Phi}$ such that $\mathbb{A}_{-\lambda,\lambda}$ of Φ coincides with \mathcal{A} – the ALE of $\check{\Phi}$ as in [19] (See Figure 14). Furthermore, we denote by $u(z)$ the harmonic function in D with boundary values $\lambda \mathbf{1}_{\partial_1}$ so that $\Phi - u(z)$ is a GFF with 0 boundary conditions in D .

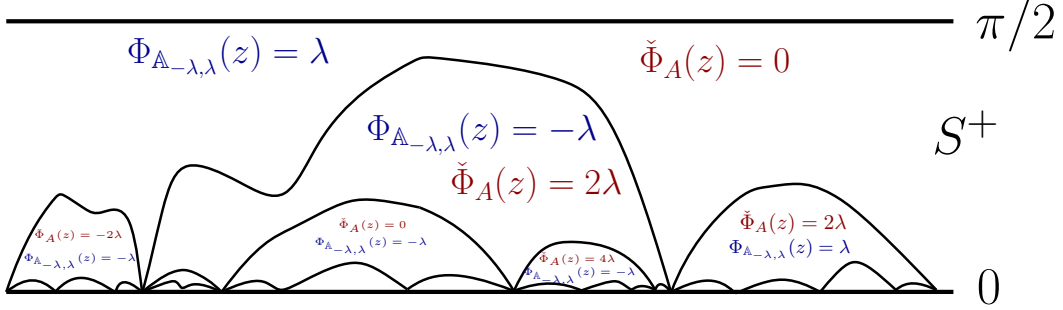

FIGURE 14. Representation of $\mathbb{A}_{-\lambda,\lambda}$ and \mathcal{A} in S^+ . The harmonic function associated to $\Phi_{\mathbb{A}_{-\lambda,\lambda}}$ takes alternating values in $\pm 2\lambda$, on the other hand $\check{\Phi}_{\mathcal{A}}$ starts with value 0 on top and each time it crosses an curve changes values of $\pm 2\lambda$ independently in each connected component.

Proof of Proposition A.1. Let Φ_ϵ and $\check{\Phi}_\epsilon$ denote the ϵ -circle average of Φ and $\check{\Phi}$ respectively. A straightforward computation yields that (see for example Theorem 1.23 of [9])

$$\mathbb{E} [(\Phi_\epsilon(z) - u(z))^2] - \frac{1}{2\pi} \log(1/\epsilon) \rightarrow \frac{1}{2\pi} \log(CR(z; D)) \quad \text{as } \epsilon \rightarrow 0. \quad (42)$$

Furthermore, as $\Gamma = \frac{1}{\sqrt{2}}(\Phi - u + \check{\Phi})$ has the law of a GFF with 0 boundary conditions on \check{D} restricted to D , we have that

$$\mathbb{E} [(\check{\Phi}_\epsilon(z))^2] - \frac{1}{2\pi} \log(1/\epsilon) \rightarrow \frac{1}{\pi} \log(CR(z; \check{D})) - \frac{1}{2\pi} \log(CR(z; D)) \quad \text{as } \epsilon \rightarrow 0.$$

Now, note that the strong Markov property of the GFF implies that

$$\Phi = \Phi_{\mathbb{A}_{-\lambda,\lambda}} + \Phi^{\mathbb{A}_{-\lambda,\lambda}} \quad \text{and} \quad \check{\Phi} = \check{\Phi}_{\mathcal{A}} + \check{\Phi}^{\mathcal{A}},$$

where $\Phi_{\mathbb{A}_{-\lambda,\lambda}}$ and $\check{\Phi}_{\mathcal{A}}$ can be represented by harmonic functions thanks to [22], and conditionally on \mathcal{A} , $\Phi^{\mathbb{A}_{-\lambda,\lambda}}$ and $\check{\Phi}^{\mathcal{A}}$ are 0 boundary GFF on $D \setminus \mathcal{A}$ (conditionally) independent of $(\Phi_{\mathbb{A}_{-\lambda,\lambda}}, \check{\Phi}_{\mathcal{A}})$. Furthermore, it is possible to check that

$$\Phi_{\mathbb{A}_{-\lambda,\lambda}}(z) = \lambda O(z) \quad \text{and} \quad \check{\Phi}_{\mathcal{A}} = \sum_{k=1}^{n(z)} \xi_k,$$

where $(\xi_k)_{k=1}^\infty$ are Rademacher random variables independent of \mathcal{A} .

We compute now the expected value of $O(z)$. To do this, we use the strong Markov property of the GFF Φ with respect to $\mathbb{A}_{-\lambda,\lambda}$ to see that

$$u(z) = \mathbb{E} [\Phi_{\mathbb{A}_{-\lambda,\lambda}}(z)].$$

From the above we obtain that

$$\mathbb{E} [O(z)] = u(z)/\lambda \quad \text{and when } D = S, \quad \mathbb{P}[O(z) = -1] = 1/2 - \Im(z)/\pi.$$

We now need to compute the expected value of $n(z)$. To do this, we study the square of both Γ and $\check{\Gamma}$. For the first one the Markov property implies that

$$u^2(z) = \mathbb{E} [(\Phi_\epsilon(z))^2] = \mathbb{E} [((\Phi_{\mathbb{A}_{-\lambda,\lambda}})^D)_\epsilon(z))^2] + \mathbb{E} [((\Phi^{\mathbb{A}_{-\lambda,\lambda}})_\epsilon(z))^2].$$

Thus

$$\begin{aligned} u^2(z) &= \mathbb{E} [((\Phi_{\mathbb{A}_{-\lambda,\lambda}})_\epsilon(z))^2] + \mathbb{E} [((\Phi^{\mathbb{A}_{-\lambda,\lambda}})_\epsilon(z))^2 - (\Phi_\epsilon(z) - u(z))^2] \\ &\rightarrow \lambda^2 + \frac{1}{2\pi} \mathbb{E} \left[\log \left(\frac{CR(z; D \setminus \mathbb{A}_{-2\lambda, 2\lambda})}{CR(z; D)} \right) \right] \quad \text{as } \epsilon \rightarrow 0. \end{aligned} \quad (43)$$

On the other hand, using \mathcal{A} instead of $\mathbb{A}_{-\lambda,\lambda}$ and $\check{\Phi}$ instead of Φ we have that

$$\mathbb{E} [(\check{\Phi}_\epsilon(z))^2] = \mathbb{E} [((\check{\Phi}_{\mathcal{A}})_\epsilon(z))^2] + \mathbb{E} [((\check{\Phi}^{\mathcal{A}})_\epsilon(z))^2]. \quad (44)$$

From here we obtain that

$$\begin{aligned} 0 &= \mathbb{E} [((\check{\Phi}_{\mathcal{A}})_\epsilon(z))^2] + \mathbb{E} [((\check{\Phi}^{\mathcal{A}})_\epsilon(z))^2 - (\check{\Phi}_\epsilon(z))^2] \\ &\rightarrow \mathbb{E} \left[\left(u(z) + 2\lambda \sum_{k=1}^{n(z)} \xi_k \right)^2 \right] + \frac{1}{2\pi} \mathbb{E} [-2 \log(CR(z; \check{D})) + \log(CR(z; D)) + \log(CR(z; D \setminus \mathcal{A}))] \\ &= u(z) + 4\lambda^2 \mathbb{E} [n(z)] + \frac{1}{2\pi} \mathbb{E} [-2 \log(CR(z; \check{D})) + \log(CR(z; D)) + \log(CR(z; D \setminus \mathcal{A}))]. \end{aligned}$$

As $\mathcal{A} = \mathbb{A}_{-\lambda,\lambda}$, we have as a consequence

$$\mathbb{E} [n(z)] = \frac{1}{4} - \frac{u^2(z)}{\pi^2} - \frac{2}{\pi^2} (\log(CR(z; D)) - \log(CR(z; \check{D}))).$$

In particular, this means that when $D = S^+$ we have that

$$\mathbb{E} [n(z)] = \frac{1}{4} - \frac{(\Im(z))^2}{\pi^2} - \frac{2}{\pi^2} \log(\sin(\Im(z))).$$

□

APPENDIX B. INVERSE KASTELEYN MATRIX IN TEMPERLEYAN DOMAINS

In this section, the inverse Kasteleyn matrix on Temperleyan domains will often be called the *coupling function* as in the original work of [15]. We detail why it also works near the boundary. We use the notation and setting of Section 3. We start by recalling some well-known facts on the coupling function and discrete holomorphic functions. The acquainted reader can jump directly to the statements of Lemma B.2 and Lemma B.3.

Let U be an open set, U_ϵ an approximating sequence as in Definition 3.1 and \mathcal{G}_ϵ the associated Temperleyan approximation with a boundary vertex b_0 removed as in Section 3. Note that these results are applied to $U = U^r$ in Section 4. To simplify notations, we will write $B = B(\mathcal{G}_\epsilon)$, $B_0 = B_0(\mathcal{G}_\epsilon)$ etc. We use the usual Kasteleyn phases of discrete holomorphy described in Equation (3) and denote by \tilde{K} the associated Kasteleyn matrix as in the proof of Theorem 3.4. It can be checked that

$$\tilde{K}^* \tilde{K} = \Delta,$$

where the Laplacian has Dirichlet boundary conditions on B_0 and Neumann boundary conditions on B_1 except at b_0 where it has Dirichlet boundary conditions. The determinant of the right hand side counts tiling of a Temperleyan domain which are in bijection with spanning

trees of B_1 rooted at b_0 , hence it is positive, so $\det \tilde{K}$ is also positive and \tilde{K} is invertible: we call its inverse \tilde{K}^{-1} the coupling function.

In this section only, we use the operator notation $K(w, b)$ instead of the matrix notation $K_{w,b}$ to align with the notation of Kenyon. Let us fix $w \in W_0$ (the same holds for $w \in W_1$). We first recall how the coupling function $b \rightarrow K^{-1}(b, w)$ can be seen as a discrete meromorphic function: we call the *real part* the restriction to $b \in B_0$ and the *imaginary part* the restriction to $b \in B_1$. This is justified by the following:

$$\begin{aligned} \tilde{K}^{-1}(b, w) &= (G\tilde{K}^*)(b, w) \\ &= G\left(b, w + \frac{\varepsilon}{2}\right) - G\left(b, w - \frac{\varepsilon}{2}\right) + i\left[G\left(b, w - \frac{i\varepsilon}{2}\right) - G\left(b, w + \frac{i\varepsilon}{2}\right)\right], \end{aligned}$$

where $G = \Delta^{-1}$ is the Green's function. The function G takes real values because the Laplacian Δ takes real values. Further, since the Laplacian has a block structure (it is non zero only from B_0 to B_0 and B_1 to B_1), G has the same block structure. Hence, since $w \in W_0$, $w \pm \frac{\varepsilon}{2} \in B_0$ while $w \pm \frac{i\varepsilon}{2} \in B_1$, so $\tilde{K}^{-1}(b, w)$ is real for $b \in B_0$ and pure imaginary for $b \in B_1$ (justifying the terminology “real” and “imaginary” part).

Let us define $\partial^{out} B_0$ (the full red and blue circles on Figure 15) to be the vertices in $B_0(\varepsilon\mathbb{Z}^2) \setminus B_0$ (where $B_0(\varepsilon\mathbb{Z}^2)$ are the vertex of the dual graph of $\varepsilon\mathbb{Z}^2$ i.e. the faces of $\varepsilon\mathbb{Z}^2$ at distance ε from a vertex of B_0 (see Kenyon, section 4.1) and $\partial^{out} B_1 = \{b_0\}$ (full red square on Figure 15). Define $\overline{B_0} = B_0 \cup \partial^{out} B_0$, $\overline{B_1} = B_1 \cup \partial^{out} B_1$ and $\overline{B} = \overline{B_0} \cup \overline{B_1}$. If we extend $b \in B_0 \rightarrow \tilde{K}^{-1}(b, w)$ by 0 on the vertices of $\partial^{out} B_0$, it is a harmonic function on B_0 except at two points: $\Delta\tilde{K}^{-1}(\cdot, w)|_{B_0} = \delta_{w+\varepsilon/2} - \delta_{w-\varepsilon/2}$. Indeed, for $b \in B_0$,

$$\Delta\tilde{K}^{-1}(b, w) = \tilde{K}^* \tilde{K} \tilde{K}^{-1}(b, w) = \tilde{K}^*(b, w) = \overline{\tilde{K}(w, b)} = \delta_{b=w+\varepsilon/2} - \delta_{b=w-\varepsilon/2} \quad (45)$$

as a function of $b \in B_0$. Observe that this already fully characterizes the real part: there is a unique function which satisfies (45) and is 0 on $\partial^{out} B_0$ (by the maximum principle). If we extend the imaginary part $b \in B_1 \rightarrow \tilde{K}^{-1}(b, w)$ by 0 on b_0 , the imaginary and real part are *harmonically conjugated*: $\tilde{K}\tilde{K}^{-1} = I$ implies that for $w' \neq w$,

$$\tilde{K}^{-1}\left(w' + \frac{\varepsilon}{2}, w\right) - \tilde{K}^{-1}\left(w' - \frac{\varepsilon}{2}, w\right) + i\left[\tilde{K}^{-1}\left(w' + \frac{i\varepsilon}{2}, w\right) - \tilde{K}^{-1}\left(w' - \frac{i\varepsilon}{2}, w\right)\right] = 0 \quad (46)$$

(which also holds when w' is on the boundary due to the choice of boundary conditions). This is the discrete Cauchy Riemann equation for $\tilde{K}^{-1}(\cdot, w)$ around the point w' .

In our case (and unlike Kenyon who considers multiply connected domains), the imaginary part is fully defined by saying that it is the harmonic conjugate of the real part and it is 0 at the removed vertex b_0 : by discrete integration along paths which avoid the singularity at w , the values of $\tilde{K}^{-1}(\cdot, w)$ on B_1 can be uniquely recovered from the values on B_0 and the boundary conditions at b_0 . We summarize all this in a lemma:

LEMMA B.1. *The inverse Kasteleyn matrix \tilde{K}^{-1} is uniquely defined, and for $w \in W_0$ fixed, it is characterized by the following:*

- its real part is the (unique) harmonic function on $\overline{B_0}$ which is 0 on $\partial^{out} B_0$ (Dirichlet boundary conditions) and satisfies

$$(\Delta\tilde{K}^{-1})(\cdot, w) = \delta_{w+\varepsilon/2} - \delta_{w-\varepsilon/2}$$

- its imaginary part is 0 at b_0
- its real and imaginary part satisfy the discrete Cauchy Riemann equation (46) at all points $w' \in W \setminus \{w\}$.

We are now ready to give estimates of the coupling function. Let $\tilde{g}(u, v)$ be the analytic function of v whose real part is the Dirichlet Green's function $g(u, v)$ on U . Also define, as in Section 6.3 of [17],

$$F_+(u, v) = \frac{\partial \tilde{g}(u, v)}{\partial u} \quad ; \quad F_-(u, v) = \frac{\partial \tilde{g}(u, v)}{\partial \bar{u}}. \quad (47)$$

Then, the following lemma holds:

LEMMA B.2. [[15], Theorem 13] *Let $\eta > 0$ be fixed. If $u \in V(\mathcal{G}_\varepsilon)$ is at distance at least η from the boundary and $v \in V(\mathcal{G}_\varepsilon)$ is at distance at least η from u , and if b and w are within $O(\varepsilon)$ of u and v respectively, then*

$$\tilde{K}^{-1}(b, w) = \begin{cases} \varepsilon \operatorname{Re}(F_+(u, v) + F_-(u, v)) + O(\varepsilon^2) & \text{if } w \in W_0, b \in B_0 \\ \varepsilon i \operatorname{Im}(F_+(u, v) + F_-(u, v)) + O(\varepsilon^2) & \text{if } w \in W_0, b \in B_1 \\ \varepsilon \operatorname{Re}(F_+(u, v) - F_-(u, v)) + O(\varepsilon^2) & \text{if } w \in W_1, b \in B_1 \\ \varepsilon i \operatorname{Im}(F_+(u, v) - F_-(u, v)) + O(\varepsilon^2) & \text{if } w \in W_1, b \in B_0 \end{cases}$$

or for short, if $r, s \in \{\pm 1\}$ are such that $w \in W_{\frac{1-r}{2}}$, $b \in W_{\frac{1-s}{2}}$,

$$\tilde{K}^{-1}(b, w) = \frac{1}{2} \left(F_+(u, v) + r F_-(u, v) + s \overline{F_-(u, v)} + r s \overline{F_+(u, v)} \right) + O(\varepsilon^2)$$

where the $O(\varepsilon^2)$ is uniform once η is fixed.

We only need the simplest part of the proof since the points u, v we consider are at distance of order 1 (and not ε) from each other and the domain is simply connected so the harmonic conjugate is single-valued. Actually, this lemma also works for points near the boundary: this is mostly Theorem 14 of [17], but we make some arguments more precise.

LEMMA B.3. *Assume (as in Section 3) that there exists $z_\partial \in \partial U$ and $\delta > 0$ such that the boundary of U is horizontal in the neighbourhood $B(z_\partial, \delta)$ and that U is contained in the half plane below this flat horizontal boundary. Assume that U_ε also has a flat and horizontal boundary in $B(z_\partial, \delta)$. Then for all $r, s \in \{\pm 1\}$, $w \in W_{\frac{1-r}{2}}(\mathcal{G}_\varepsilon)$, $b \in B_{\frac{1-s}{2}}(\mathcal{G}_\varepsilon)$ each at distance at most $\delta/2$ of z_∂ or at distance at least $\delta/2$ from the boundary of U , if $|b - w| \geq \delta/2$ and if w and b are within $O(\varepsilon)$ of $u, v \in U$ respectively, then*

$$\tilde{K}^{-1}(b, w) = \frac{1}{2} \left(F_+(u, v) + r F_-(u, v) + s \overline{F_-(u, v)} + r s \overline{F_+(u, v)} \right) + O(\varepsilon^2)$$

where the $O(\varepsilon^2)$ is uniform once δ is fixed.

In particular, with the notation of the lemma,

$$|\tilde{K}^{-1}(b, w)| \leq C(\delta)\varepsilon \quad (48)$$

for some constant C depending only on δ .

REMARK B.4. *These two lemmas could actually be proved in a slightly more general setting when $\delta = \delta(\varepsilon) \xrightarrow{\varepsilon \rightarrow 0} 0$.*

The proof consists in detailing some arguments in the proof of Theorem 14 of [15] (more precisely we use the argument of Corollary 19) but our statement applies to all points at distance at most $\delta/2$ from z_∂ , unlike the statement of Kenyon which applies only to the points within $O(\varepsilon)$ of the boundary.

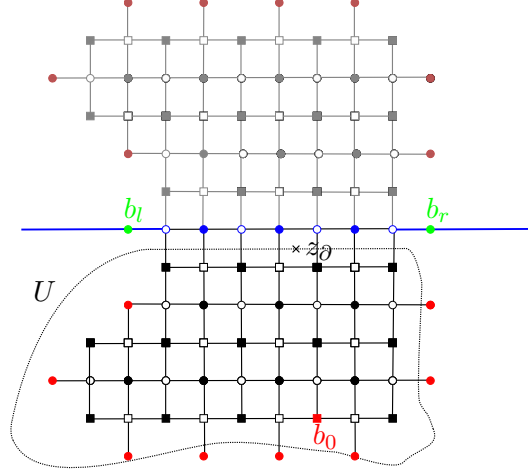

FIGURE 15. The graph \mathcal{G}_ε near the point z_∂ and the flat boundary is drawn in black. The boundary points on the flat boundary $\partial^{flat}B_0$ are represented as full blue circles. The rest of the boundary $\partial^{out}B_0$ is represented by full red circles. These are the point with Dirichlet boundary condition for the coupling function. The reflection axis is drawn as a blue line and the reflected vertices are drawn in grey for the bulk vertices and light red for the boundary vertices.

Proof. We have to deal with the fact that w might be close to the boundary so Lemma B.2 would not apply. Let $\partial^{flat}B_0$ be the set of the uppermost points of $\partial^{out}B_0$ (full blue circles in Figure 15). They are all situated on the same horizontal line (full blue line in Figure 15). We call s the reflection along this line. We also define $\partial^{flat}W_0$ (the empty blue circles in Figure 15) to be the vertices in $W_0(\mathbb{Z}^2)$ (the horizontal edges of $\varepsilon\mathbb{Z}^2$) which are at distance $\varepsilon/2$ from a point in $\partial^{flat}B_0$, and we define $\overline{W}_0 = W_0 \cup \partial^{flat}W_0$, $\overline{W} = \overline{W}_0 \cup W_1$. We consider a new graph $\mathcal{G}_\varepsilon^s$ which has vertex set $B \cup \overline{W} \cup \partial^{flat}B_0 \cup s(B) \cup s(\overline{W}) \cup \{s(b_0)\}$ (the grey, black and blue points in Figure 15) where we identify the points of $\partial^{flat}B_0$ and $\partial^{flat}W_0$ and their image (they are fixed by the reflection). The edges of $\mathcal{G}_\varepsilon^s$ link points at distance $\varepsilon/2$. The boundary of $\mathcal{G}_\varepsilon^s$ is $\partial^{out}B_0 \cup s(\partial^{out}B_0) \cup \{b_0, b_l, b_r\} \setminus \partial^{flat}B_0$ (the red, light red and green points in Figure 15) where b_l, b_r are two added points (in green on Figure 15): b_l at distance ε to the left of the leftmost point in $\partial^{flat}B_0$ and b_r at distance ε to the right of the rightmost point in $\partial^{flat}B_0$. We will write B^s for the black vertices of $\mathcal{G}_\varepsilon^s$, $\overline{\mathcal{G}}_\varepsilon^s$ for the union of $\mathcal{G}_\varepsilon^s$ and its boundary, etc.

We can extend the discrete meromorphic function $\tilde{K}^{-1}(\cdot, w)$ on \overline{B}^s by a discrete analogue of the Schwarz reflection principle for holomorphic functions. We define, for $b \in \overline{B}$,

$$\tilde{K}_s^{-1}(s(b), w) = \begin{cases} -\tilde{K}^{-1}(w, b) & \text{if } b \in \overline{B}_0 \\ \tilde{K}^{-1}(w, b) & \text{if } b \in \overline{B}_1 \end{cases} \quad (49)$$

and set $\tilde{K}^{-1}(b_l, w) = \tilde{K}^{-1}(b_r, w) = 0$. This extended function is well defined (the only problem could be for $b \in \partial^{flat}B_0$ for which $s(b) = b$, but in this case $\tilde{K}^{-1}(w, b) = \tilde{K}^{-1}(w, s(b)) = 0$). It is discrete meromorphic on \mathcal{G}^s : harmonicity of the real and imaginary parts (except at w and $s(w)$) is preserved on and near the reflection axis (Definition (49) is designed to match the Dirichlet and Neumann boundary conditions). Besides, $b \in B_1^s \rightarrow \tilde{K}_s^{-1}(b, w)$ remains

harmonically conjugated to $b \in B_0^s \rightarrow \tilde{K}_s^{-1}(b, w)$ except at w and $s(w)$: using the definition of the extension \tilde{K}^{-1} and the discrete Cauchy Riemann equation (46), if $w' \in W_0 \setminus \{w\}$, $s(w) \in W_0^s$ and if we let

$$\partial_x \tilde{K}^{-1}(s(w'), w) = \tilde{K}^{-1}\left(s(w') + \frac{\varepsilon}{2}, w\right) - \tilde{K}^{-1}\left(s(w') - \frac{\varepsilon}{2}, w\right)$$

then

$$\begin{aligned} \partial_x \tilde{K}^{-1}(s(w'), w) &= \tilde{K}^{-1}\left(s\left(w' + \frac{\varepsilon}{2}\right), w\right) - \tilde{K}^{-1}\left(s\left(w' - \frac{\varepsilon}{2}\right), w\right) \\ &= -\left[\tilde{K}^{-1}\left(w' + \frac{\varepsilon}{2}, w\right) - \tilde{K}^{-1}\left(w' - \frac{\varepsilon}{2}, w\right)\right] \\ &= i\left[\tilde{K}^{-1}\left(w' + \frac{i\varepsilon}{2}, w\right) - \tilde{K}^{-1}\left(w' - \frac{i\varepsilon}{2}, w\right)\right] \\ &= i\left[\tilde{K}^{-1}\left(s\left(w' + \frac{i\varepsilon}{2}\right), w\right) - \tilde{K}^{-1}\left(s\left(w' - \frac{i\varepsilon}{2}\right), w\right)\right] \\ &= i\left[\tilde{K}^{-1}\left(s(w') - \frac{i\varepsilon}{2}, w\right) - \tilde{K}^{-1}\left(s(w') + \frac{i\varepsilon}{2}, w\right)\right] \\ &= -i\left[\tilde{K}^{-1}\left(s(w') + \frac{i\varepsilon}{2}, w\right) - \tilde{K}^{-1}\left(s(w') - \frac{i\varepsilon}{2}, w\right)\right] \end{aligned}$$

which is exactly the discrete Cauchy Riemann equation (46) at $s(w')$ (note how the reflection changes the signs only for vertical differences). This also holds for $w \in W_1$ (but there is an additional minus sign in the first line and no sign in the last line, which compensate).

We now show that the extended coupling function $b \in B^s \rightarrow \tilde{K}_s^{-1}(b, w)$ coincides with the difference of two coupling functions on B^s . Since $\mathcal{G}_\varepsilon^s$ is a Temperleyan approximation of $U \cup s(U)$ if we remove the vertex b_0 , by Lemma B.1 for fixed $w \in W_0 \cup s(W_0)$, the coupling function $b \in B^s \rightarrow H^s(b, w)$ is uniquely defined: its real part has 0 boundary conditions on $\partial^{out} B_0 \cup s(\partial^{out} B_0) \cup \{b_l, b_r\} \setminus \partial^{flat} B_0$ and satisfies $\Delta H^s(\cdot, w) = \delta_{w+\varepsilon/2} - \delta_{w-\varepsilon/2}$ at all inner points $b \in B_0^s$. Its imaginary part is 0 on b_0 and is harmonically conjugated with the real part except at w . We claim that for all $b \in B_0^s$,

$$\tilde{K}_s^{-1}(b, w) = H^s(b, w) - H^s(b, s(w)). \quad (50)$$

Indeed, the two sides of the equation have the same Laplacian $\delta_{w+\varepsilon/2} - \delta_{w-\varepsilon/2} - \delta_{s(w)+\varepsilon/2} + \delta_{s(w)-\varepsilon/2}$ and both have zero boundary conditions on B_0^s , so the real parts coincide. Hence, the difference $b \in B_1^s \rightarrow H^s(b, w) - H^s(b, s(w))$ is harmonically conjugated (except at w and $s(w)$) with $b \in B_0^s \rightarrow \tilde{K}_s^{-1}(b, w) = H^s(b, w) - H^s(b, s(w))$ and it is zero at b_0 , so it coincides with $b \in B_1^s \rightarrow \tilde{K}_s^{-1}(b, w)$ by integration along any path from b_0 to b avoiding w and $s(w)$. Finally, Equation 50 also holds for $b \in B_1^s$.

REMARK B.5. Observe that we did not impose any condition at $s(b_0)$ for $H^s(b, w) - H^s(b, s(w))$, but since equality (50) holds it must be 0 a posteriori. This can be checked using symmetry arguments.

B_1^s is an approximating sequence for $U \cup s(U)$ so we can apply Lemma B.2 to conclude, because (and this is the key point of the proof) if w is as in the statement of the Lemma, then both w and $s(w)$ are at distance at least $\delta/2$ from the boundary of B^s : the points near the flat part of the boundary around z_∂ have become inner points of the graph B^s . In particular, the points in B at distance at most $\delta/2$ from z_∂ are at distance at least $\delta/2$ from

the boundary of B^s , so we can apply Lemma B.2 with $\eta = \delta/2$ to $H^s(\cdot, w)$ and $H^s(\cdot, s(w))$ since they are the coupling function for the Temperleyan approximation of $U \cup s(U)$ with a black vertex removed at the same location as before.

If we denote by $\tilde{g}^s(u, v)$ the analytic function of v whose real part is the Dirichlet Green's function $g^s(u, v)$ on $U \cup s(U)$, we define F_+^s and F_-^s similarly to the definition before Lemma B.2. If w is at distance $O(\varepsilon)$ from u and b is at distance $O(\varepsilon)$ from v ,

$$\tilde{K}^{-1}(b, w) = \begin{cases} \varepsilon \operatorname{Re} [F_+^s(u, v) + F_-^s(u, v) - F_+^s(s(u), v) - F_-^s(s(u), v)] & +O(\varepsilon^2) \\ & \text{if } b \in B_0, \\ \varepsilon i \operatorname{Im} [F_+(u, v) + F_-(u, v) - F_+^s(s(u), v) - F_-^s(s(u), v)] & +O(\varepsilon^2) \\ & \text{if } b \in B_1. \end{cases}$$

where the $O(\varepsilon^2)$ is uniform once δ is fixed. Observe now (this is the continuous equivalent of what we have just done, i.e. Schwarz reflection principle in the continuum) that $\tilde{g}^s(u, v) - \tilde{g}^s(s(u), v) = \tilde{g}(u, v)$ when $u, v \in U$, because the left-hand side is analytic in v on U , its real part $g^s(u, v) - g^s(s(u), v)$ has the same pole as $g(u, v)$ in v (by definition as a Green's function) and it is 0 on the boundary of U . On the flat portion, it is true by symmetry: if v is on the reflection axis, $g^s(u, v) = g^s(s(u), s(v)) = g^s(s(u), v)$. On the rest of the boundary both terms of the difference vanish since v is also on the boundary of $U \cup s(U)$. Hence, $F_+^s(u, v) - F_+^s(s(u), v) = F_+(u, v)$ and $F_-^s(u, v) - F_-^s(s(u), v) = F_-(u, v)$ which concludes the proof in the case $w \in W_0$; Lemma B.2 holds up to the boundary.

To deal with the case $w \in W_1$, the same argument works but now $\tilde{K}^{-1}(\cdot, w)|_{B_0}$ is the unique function on B_0 which is 0 on $\partial^{out} B_0$ and whose Laplacian is $-i\delta_{b=w+i\varepsilon/2} + i\delta_{b=w-i\varepsilon/2}$ by equation (45) applied when $w \in W_1$ instead of $w \in W_0$. The remaining changes are straightforward. \square

APPENDIX C. COUPLING FUNCTION IN PIECEWISE TEMPERLEYAN DOMAINS.

We use the setting of Section 3: U^r is a simply connected open set symmetric with respect to the horizontal axis, $U = U^r \cap \mathbb{R} \times \mathbb{R}_{>0}$. The boundary of U can be partitioned in two connected arcs: $\partial U = D \sqcup N$ where $N = \partial U \cap \mathbb{R} \times \{0\}$ is the intersection with the horizontal axis. Recall that we defined two graphs approximating U : the Temperleyan approximation $\mathcal{G}_\varepsilon^1$ with Dirichlet boundary conditions (and a vertex b_0 removed) and the piecewise Temperleyan approximation $\mathcal{G}_\varepsilon^2$ with two convex white corners v_1^*, v_2^* . In both cases, we use the usual Kasteleyn phases of discrete holomorphy described in Equation (3), and denote by K^1, K^2 the corresponding Kasteleyn matrices on $\mathcal{G}_\varepsilon^1, \mathcal{G}_\varepsilon^2$. Both $\mathcal{G}_\varepsilon^1$ and $\mathcal{G}_\varepsilon^2$ have at least one dimer configuration (for example because from any loops and arcs configuration $\omega \in \Omega(\mathcal{G}_\varepsilon)$ we can obtain two dimer covers of $\mathcal{G}_\varepsilon^1$ and $\mathcal{G}_\varepsilon^2$), hence K^1 and K^2 are invertible by [20]. Moreover, the asymptotics of $(K^j)^{-1}$ on piecewise Temperleyan domains are computed and expressed in terms of $f_i^j(u, v)$ for $i \in \{0, 1\}$, $j \in \{1, 2\}$. These are the unique functions which are analytic in u for fixed v , have a simple pole of residue $1/\pi$ at $u = v$ with no other pole on \bar{U} , are bounded near v_1^*, v_2^* (for the $j = 2$ case), and have the following boundary conditions:

- $\Re(f_0^1(\cdot, v)) = 0$ on $D \sqcup N$
- $\Im(f_1^1(\cdot, v)) = 0$ on $D \sqcup N$
- $\Re(f_0^2(\cdot, v)) = 0$ on D and $\Im(f_0^1(\cdot, v)) = 0$ on N
- $\Im(f_1^2(\cdot, v)) = 0$ on D and $\Re(f_1^1(\cdot, v)) = 0$ on N .

For $\tau = \pm 1$, $i \in \{1, 2\}$, let

$$F_\tau^j = \frac{1}{2}(f_0^j + \tau f_1^j).$$

Then, Theorem 6.1 of [20] has the following corollary:

LEMMA C.1. *Let $\eta > 0$ be fixed. If $u, v \in V(\mathcal{G}_\varepsilon)$ are at distance at least η from the boundary, and if w and b are within $O(\varepsilon)$ of u and v respectively, for $j \in \{1, 2\}$, $r, s \in \{\pm 1\}$, $w \in W_{\frac{1-r}{2}}$, $b \in B_{\frac{1-s}{2}}$,*

$$(K^j)_{b,w}^{-1} = \varepsilon \left(F_+^j(u, v) + rF_-^j(u, v) + \overline{sF_-^j(u, v)} + \overline{rsF_+^j(u, v)} \right) + \Delta(w, b) + o(\varepsilon)$$

where the o is uniform once η is fixed and Δ is an error term depending only on ε , $w \in W_0 \sqcup W_1$, $b \in B_0 \sqcup B_1$ (in particular Δ does not depend on U or its Temperleyan discretization \mathcal{G}_ε).

REMARK C.2. *In the original statement of [20],*

$$\Delta(w, b) = \frac{2\varepsilon}{\lambda} F_{\mathbb{C}, w}^\varepsilon(b) - \frac{\varepsilon}{u - v}$$

where $\lambda = e^{i\frac{\pi}{4}}$ and $F_{\mathbb{C}, w}^\varepsilon$ is the unique discrete holomorphic function on $\varepsilon\mathbb{Z}^2$ tending to 0 at infinity and with a pole λ at w , which is known to be asymptotically equal to $\frac{\lambda}{2\pi(b-w)}$ when $\varepsilon \rightarrow 0$ and $|b - w| \geq \eta$ for some $\eta > 0$ independent of ε . See Section 5 of [20] for details. The error term Δ is also present in the original statement of Lemmas B.2 and B.3, but we included it in the $o(\varepsilon)$ since we never use these lemmas for close points and for all $\eta > 0$, for all b, w such that $|b - w| \geq \eta$,

$$|\Delta(w, b)| = o_{\varepsilon \rightarrow 0}(\varepsilon).$$

uniformly once η is fixed. Since we need to apply Lemma C.1 also for points b, w at distance $O(\varepsilon)$, we must include the error term.

As in Lemma B.3, when U has some specific boundary conditions, the asymptotic estimates holds up to the boundary.

LEMMA C.3. *Assume (as in Section 3) that there exists $z_\partial \in D$ and $\delta > 0$ such that the boundary of U is horizontal in the neighbourhood $B(z_\partial, \delta)$ and that U is contained in the half plane below this flat horizontal boundary. Assume that U_ε also has a flat and horizontal boundary in $B(z_\partial, \delta)$. If $u, v \in V(\mathcal{G}_\varepsilon)$ are each at distance at most $\delta/2$ of z_∂ or at least $\delta/2$ from the ∂U , and if w and b are within $O(\varepsilon)$ of u and v respectively, for $j \in \{1, 2\}$, $r, s \in \{\pm 1\}$, $w \in W_{\frac{1-r}{2}}$, $b \in B_{\frac{1-s}{2}}$,*

$$(K^j)_{b,w}^{-1} = \varepsilon \left(F_+^j(u, v) + rF_-^j(u, v) + \overline{sF_-^j(u, v)} + \overline{rsF_+^j(u, v)} \right) + \Delta(w, b) + o(\varepsilon)$$

where the o is uniform once δ is fixed and Δ is the error term from Lemma C.1.

In particular, it holds that for all b, w at distance at most $\delta/2$ of z_∂ or at least $\geq \delta/2$ from the ∂U , for all $j \in \{1, 2\}$,

$$|(K^j)_{w,b}^{-1} - \Delta(w, b)| \leq C(\delta)\varepsilon \tag{51}$$

for some constant $C(\delta)$ depending only on δ .

Proof. The same argument as in the proof of Lemma B.3 can be applied: we skip most of the details. For fixed $w \in W(\mathcal{G}_\varepsilon^j)$, for $j \in \{1, 2\}$, the coupling function $(K^j)^{-1}(\cdot, w)$ can be extended into a discrete meromorphic function $(K_s^j)^{-1}(\cdot, w)$ on the graph $(\mathcal{G}_\varepsilon^j)_s$ obtained by gluing together $\mathcal{G}_\varepsilon^j$ and $s(\mathcal{G}_\varepsilon^j)$ (the reflection of $\mathcal{G}_\varepsilon^j$ along the flat part of ∂U). Then,

$(K_s^j)^{-1}(\cdot, w)$ is a discrete meromorphic function on $B((\mathcal{G}_\varepsilon^j)^s)$, with mixed Dirichlet/Neumann boundary conditions and two poles of respective residues $1/\pi$ and $-1/\pi$ at w and $s(w)$, hence it coincides with the difference of the two coupling functions $H^s(\cdot, w) - H^s(\cdot, s(w))$ with the same mixed boundary conditions. Indeed, the difference

$$(K_s^j)^{-1}(\cdot, w) - (H^s(\cdot, w) - H^s(\cdot, s(w)))$$

is in the kernel of the (invertible) matrix K^j , hence it must vanish. We conclude by applying Lemma C.1 to $H^s(\cdot, w)$ and $H^s(\cdot, s(w))$. \square

We finally explain how $F_\tau^j, \tau = \pm 1$ can be expressed in terms of the functions $F_\tau, \tau = \pm 1$ defined in the preceding section (see Equation 47). Recall that U^r denotes the reflected domain, and denote by $f_0(u, v), f_1(u, v)$ the unique analytic functions of $u \in U^r$ having a simple pole of residue $1/\pi$ at $u = v$ and boundary conditions $\Re(f_0^r(\cdot, v)) = 0$ on ∂U^r , $\Im(f_1^r(\cdot, v)) = 0$ on ∂U^r . They satisfy

$$F_+(u, v) = f_0(u, v) + f_1(u, v) \quad ; \quad F_-(u, v) = f_0(u, v) - f_1(u, v).$$

Since U^r is invariant by reflection along the horizontal axis,

$$\forall i \in \{1, 2\}, \forall u, v \in U^r, \overline{f_i^r(\bar{u}, \bar{v})} = f_i^r(u, v).$$

Checking the boundary conditions in each case, it holds that:

- $f_0^1(u, v) = f_0(u, v) - f_0(u, \bar{v})$
- $f_1^1(u, v) = f_1(u, v) + f_1(u, \bar{v})$
- $f_0^2(u, v) = f_0(u, v) + f_0(u, \bar{v})$
- $f_1^2(u, v) = f_1(u, v) - f_1(u, \bar{v})$

Or, to put it shortly, for $i \in \{0, 1\}, j \in \{1, 2\}$,

$$f_i^j(u, v) = f_i(u, v) + (-1)^{i+j} f_i(u, \bar{v})$$

which implies that for $\tau \in \{\pm 1\}, u, v \in U$,

$$F_\tau^j = F_\tau(u, v) + (-1)^j F_{-\tau}(u, \bar{v}). \quad (52)$$

REFERENCES

- [1] L. V. Ahlfors. *Complex Analysis*. McGraw-Hill Book Company, 2 edition.
- [2] J. Aru, T. Lupu, and A. Sepúlveda. First passage sets of the 2D continuum Gaussian free field. *Probability Theory and Related Fields*, 176(3):1303–1355, 2020.
- [3] J. Aru and A. Sepúlveda. Two-valued local sets of the 2d continuum gaussian free field: connectivity, labels, and induced metrics. *Electronic Journal of Probability*, 23:1–35, 2018.
- [4] J. Aru, A. Sepúlveda, and W. Werner. On bounded-type thin local sets of the two-dimensional gaussian free field. *Journal of the Institute of Mathematics of Jussieu*, 18(3):591–618, 2019.
- [5] Mikhail Basok and Dmitry Chelkak. Tau-functions à la dubédat and probabilities of cylindrical events for double-dimers and cle (4). *Journal of the European Mathematical Society*, 23(8):2787–2832, 2021.
- [6] Nathanaël Berestycki, Benoit Laslier, and Gourab Ray. Dimers and imaginary geometry. *The Annals of Probability*, 48(1):1–52, 2020.
- [7] Nathanaël Berestycki, Marcin Lis, and Wei Qian. Free boundary dimers: random walk representation and scaling limit. *Probability Theory and Related Fields*, 186(3):735–812, 2023.
- [8] Nathanaël Berestycki and Mingchang Liu. Piecewise temperleyan dimers and a multiple sle $_{.8}$. *arXiv preprint arXiv:2301.08513*, 2023.
- [9] Nathanaël Berestycki and Ellen Powell. Gaussian free field and Liouville quantum gravity. *arXiv preprint arXiv:2404.16642*, 2024.
- [10] David Cimasoni and Nicolai Reshetikhin. Dimers on surface graphs and spin structures. i. *Communications in Mathematical Physics*, 275:187–208, 10 2007.

- [11] Daniel Douglas, Richard Kenyon, and Haolin Shi. Dimers, webs, and local systems. *Transactions of the American Mathematical Society*, 377, 05 2022.
- [12] Daniel Douglas, Richard Kenyon, and Haolin Shi. Dimers, webs, and local systems. *Transactions of the American Mathematical Society*, 377(02):921–950, 2024.
- [13] Julien Dubédat. Double dimers, conformal loop ensembles and isomonodromic deformations. *Journal of the European Mathematical Society*, 21(1):1–54, 2018.
- [14] H. Duminil-Copin, M. Lis, and W. Qian. Conformal invariance of double random currents I: identification of the limit. arXiv:2107.12985, 2021.
- [15] Richard Kenyon. Conformal invariance of domino tiling. *Ann. Probab.*, 28(2):759–795, 2000.
- [16] Richard Kenyon. Dominos and the Gaussian free field. *Ann. Probab.*, 29(3):1128–1137, 2001.
- [17] Richard Kenyon. Conformal Invariance of Loops in the Double-Dimer Model. *Communications in Mathematical Physics*, 326(2):477–497, Mar 2014.
- [18] Richard W. Kenyon, James G. Propp, and David B. Wilson. Trees and matchings. *Electron. J. Combin.*, 7:Research Paper 25, 34, 2000.
- [19] Wei Qian and Wendelin Werner. Coupling the gaussian free fields with free and with zero boundary conditions via common level lines. *Communications in Mathematical Physics*, 361(1):53–80, 2018.
- [20] Marianna Russkikh. Dimers in piecewise temperleyan domains. *Communications in Mathematical Physics*, 359(1):189–222, 2018.
- [21] Oded Schramm and Scott Sheffield. A contour line of the continuum gaussian free field. *Probability Theory and Related Fields*, 157(1-2):47–80, 2013.
- [22] Avelio Sepúlveda. On thin local sets of the Gaussian free field. *Ann. Inst. Henri Poincaré Probab. Stat.*, 55(3):1797–1813, August 2019.
- [23] H. N. V. Temperley and Michael E. Fisher. Dimer problem in statistical mechanics—an exact result. *Philos. Mag. (8)*, 6:1061–1063, 1961.