



HAL
open science

Demonstrator for the TTL Coupling Measurement in the LISA Experiment

Frédéric Cleva, Jean-Pierre Coulon, Marco Nardello, Olivier Grosjean

► **To cite this version:**

Frédéric Cleva, Jean-Pierre Coulon, Marco Nardello, Olivier Grosjean. Demonstrator for the TTL Coupling Measurement in the LISA Experiment. International Conference on Space Optics, Oct 2024, Antibes, France. hal-04744352

HAL Id: hal-04744352

<https://hal.science/hal-04744352v1>

Submitted on 18 Oct 2024

HAL is a multi-disciplinary open access archive for the deposit and dissemination of scientific research documents, whether they are published or not. The documents may come from teaching and research institutions in France or abroad, or from public or private research centers.

L'archive ouverte pluridisciplinaire **HAL**, est destinée au dépôt et à la diffusion de documents scientifiques de niveau recherche, publiés ou non, émanant des établissements d'enseignement et de recherche français ou étrangers, des laboratoires publics ou privés.

Frédéric Cleva¹ (cleva@oca.eu), J.P. Coulon¹, M. Nardello¹, O. Grosjean²

¹ Université Côte d'Azur, Observatoire de la Côte d'Azur, CNRS, ARTEMIS, NICE., ² Centre national d'études spatiales, Toulouse

* Funded by the Centre national d'études spatiales (CNES)

OVERVIEW We present some of the key functions of a setup aimed at measuring the Tilt-To-Length (TTL) coupling on the LISA optical benches. It integrates off-the-shelf components, a metallic breadboard, servo-loops and position memories for beam alignments and obtained straightforward alignments with submicrometric accuracy. The setup demonstrates an optomechanical stability better than a few microns (130 hours), compliant with the specifications for LISA.

I - LISA mission for Gravitational Waves (GW) detection and TTL coupling

Laser ranging between Free-Falling Masses in space (FFM), 2.5 Mkm length optical link, it targets ~ few picometer/ $\sqrt{\text{Hz}}$. Heterodyne detection of the optical phase between the incoming & local beams attached to the far / local FFM's.

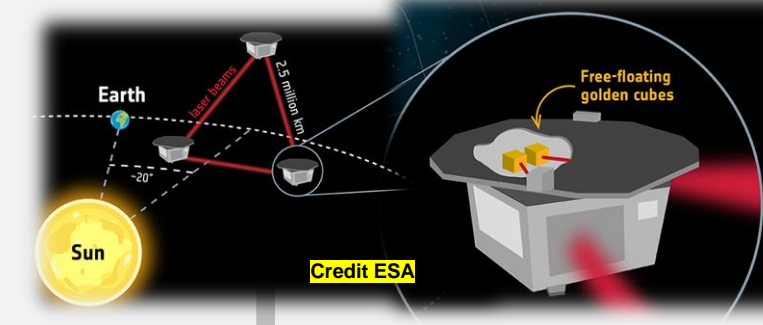

II - LISA optical bench

Aimed at detecting the Opt. Path Length "Input pupil"-to-FFM ("δφ" in rad)

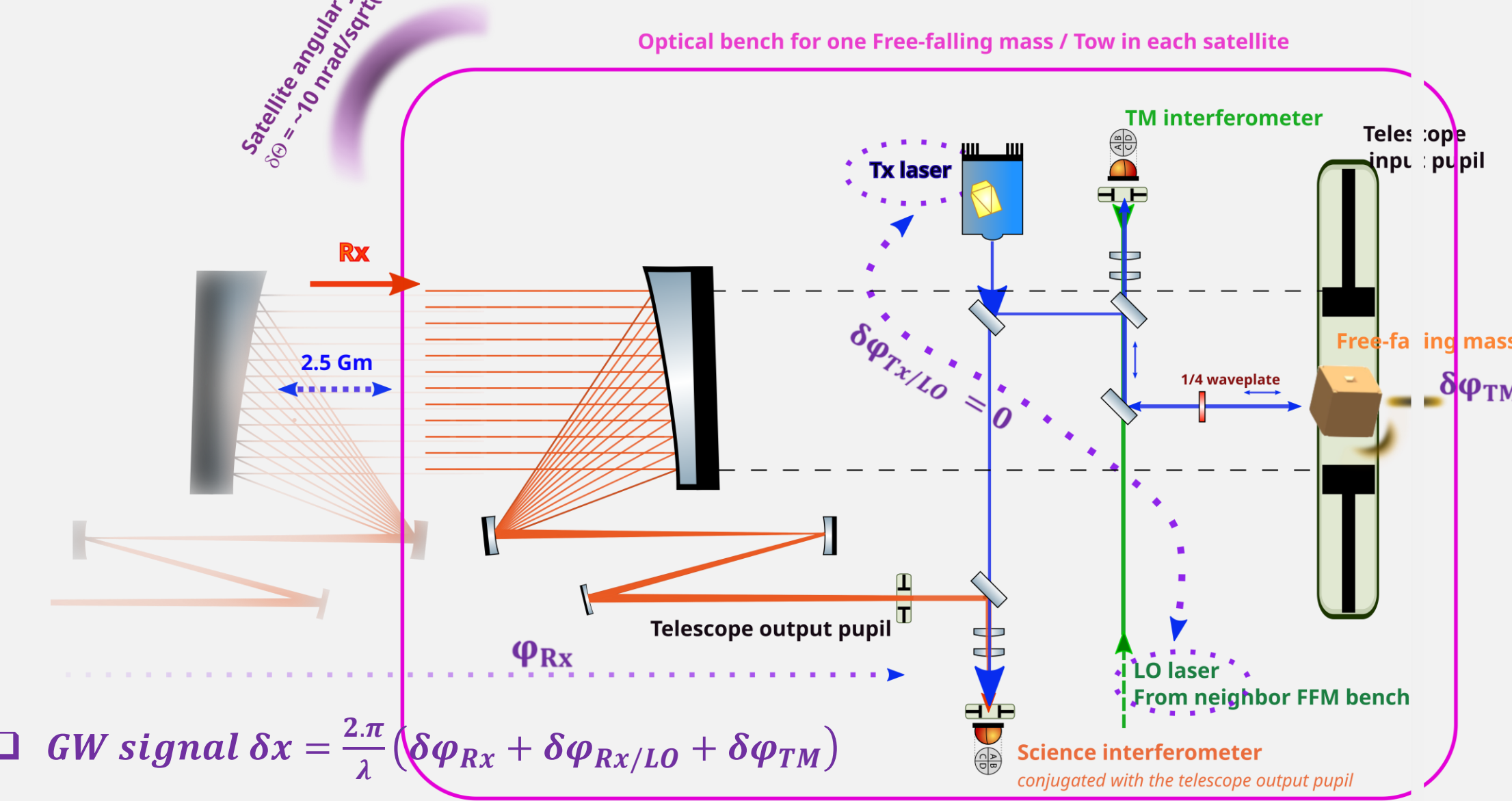

III - TTL coupling : One of the major noise source in LISA

Pupil's-to-Test Mass conjugation → OPL FFM-to-detectors unaffected by the bench/satellite angular jitter

!! Residual pupil misalignments → deleterious « Tilt-To-Length » coupling $TTL = \frac{\partial \delta x}{\partial \theta} = \Delta, \text{ in } \frac{\text{m}}{\text{rad}}$

→ FOGOB optical bench demonstrator for TTL measurement

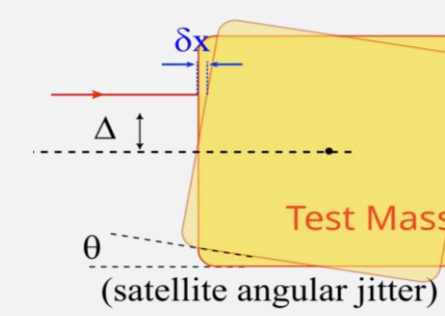

IV - FOGOB - Measurement principle

Provides Rx & LO beams, $\lambda = 1064 \text{ nm}$, ~ 10 mW

Rx is tilted ($\theta_0 \times \sin(2\pi \cdot f_0 \cdot t)$) at the output pupil center

We conjugate the FOGOB pupil with the LISA OB pupil

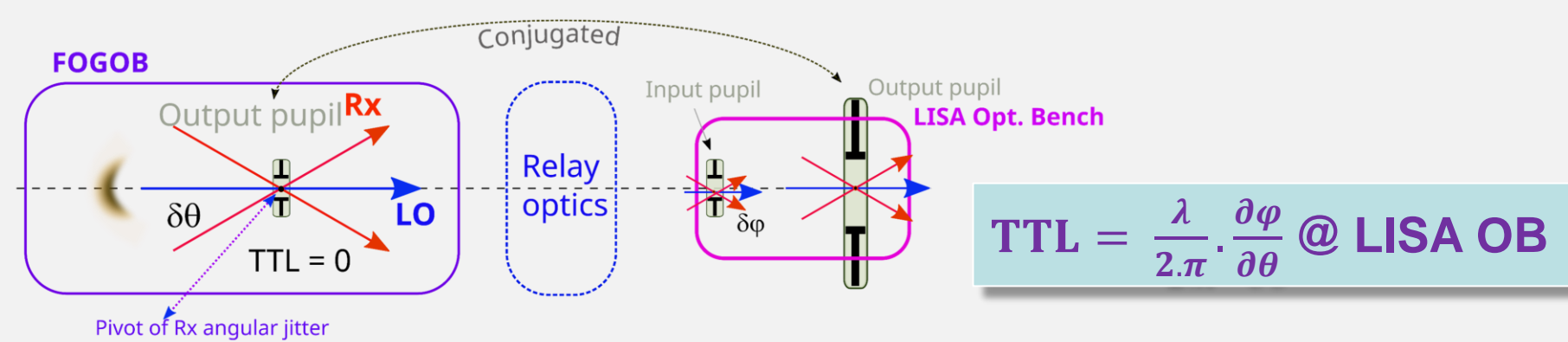

Specification: $Rx = (\theta_0 \sim 150 \mu\text{rad}) \times \sin(2\pi \cdot \text{few Hz} \cdot t)$, Pivot point centring accuracy < 15 μm, TTL @ FOGOB pupil accuracy < 10 μm/rad, over days. Std(TTL) < 10⁻⁷ m/rad for few minutes trends. Rx flattop intensity profile

V - FOGOB demonstrator - Detection scheme

Heterodyne detection scheme, data of interest: $\phi = \text{Rx-to-LO } 1 \text{ MHz beat phase}$

- Detection @ Output pupil, with a Quadrant Photo-Detector (QPD) delivers: residual « piston » = $\sum_{i=1..4} \phi_i$
 - Detection @ Twin output pupil, with a QPD delivers: Tilt Rx-wrt-LO, $\theta = \sum_{i=1..4} \pm \phi_i$
 - Detection @ Twin output pupil, with a pinhole Single Element PhotoDiode (SEPD), centered @ pupil, delivers: Rx-vs-LO phase lock Err signal
- TTL = piston @ $f_0 / \theta @ f_0$ meter/radian

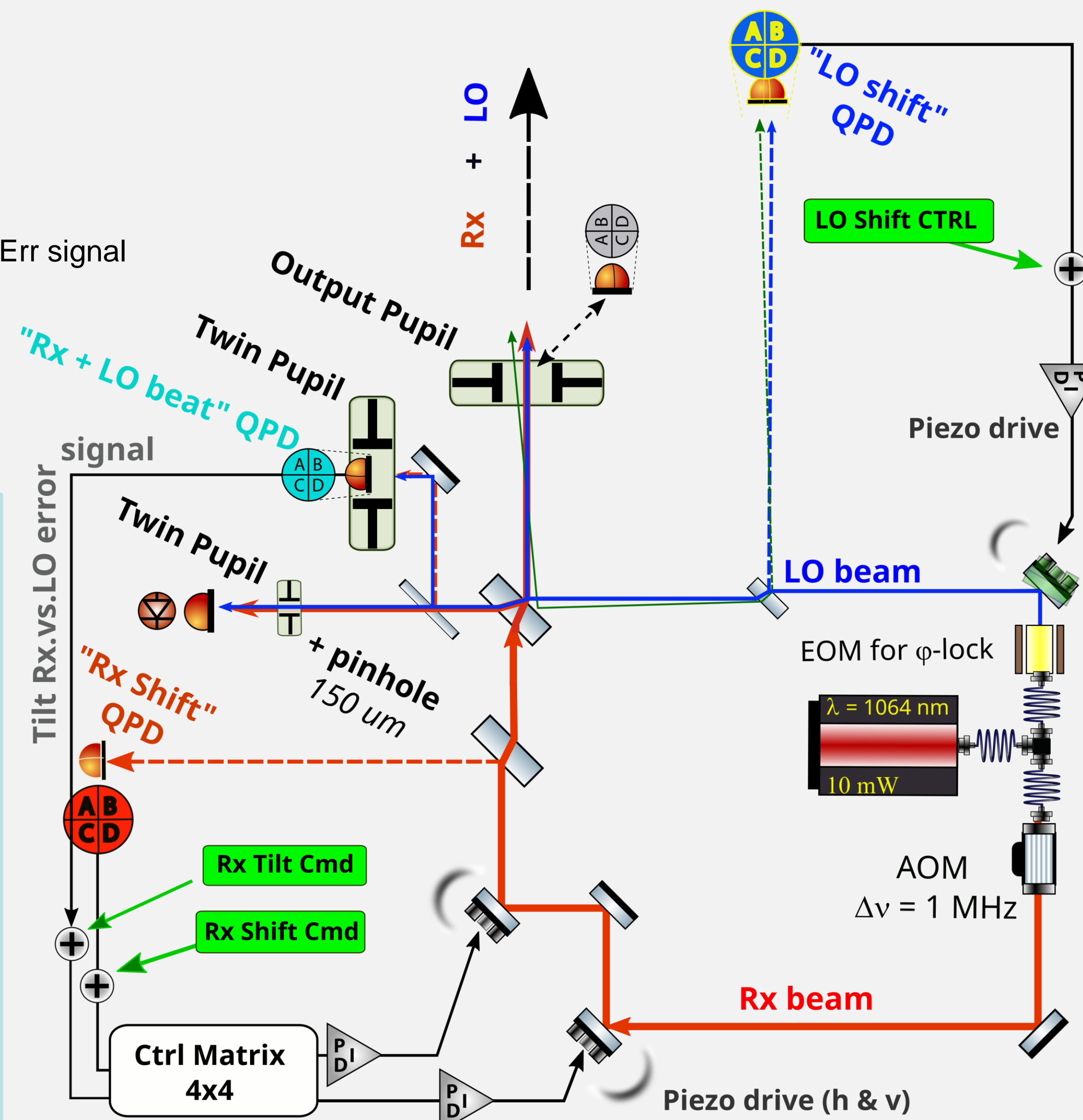

VI - FOGOB demonstrator - Flattop generation / Beam alignment Ctrl / Mechanical Stability

Flat Top intensity profile (Rx beam)

Goal: mimic a plane wave over a 2.5 mm diam. pupil. The pupil is located ~ 80 cm away from the source

Setup: SM fiber collimated using a 30 cm lens & apodization for diffraction mitigation (transmissive mask), detection @ 0.8 m

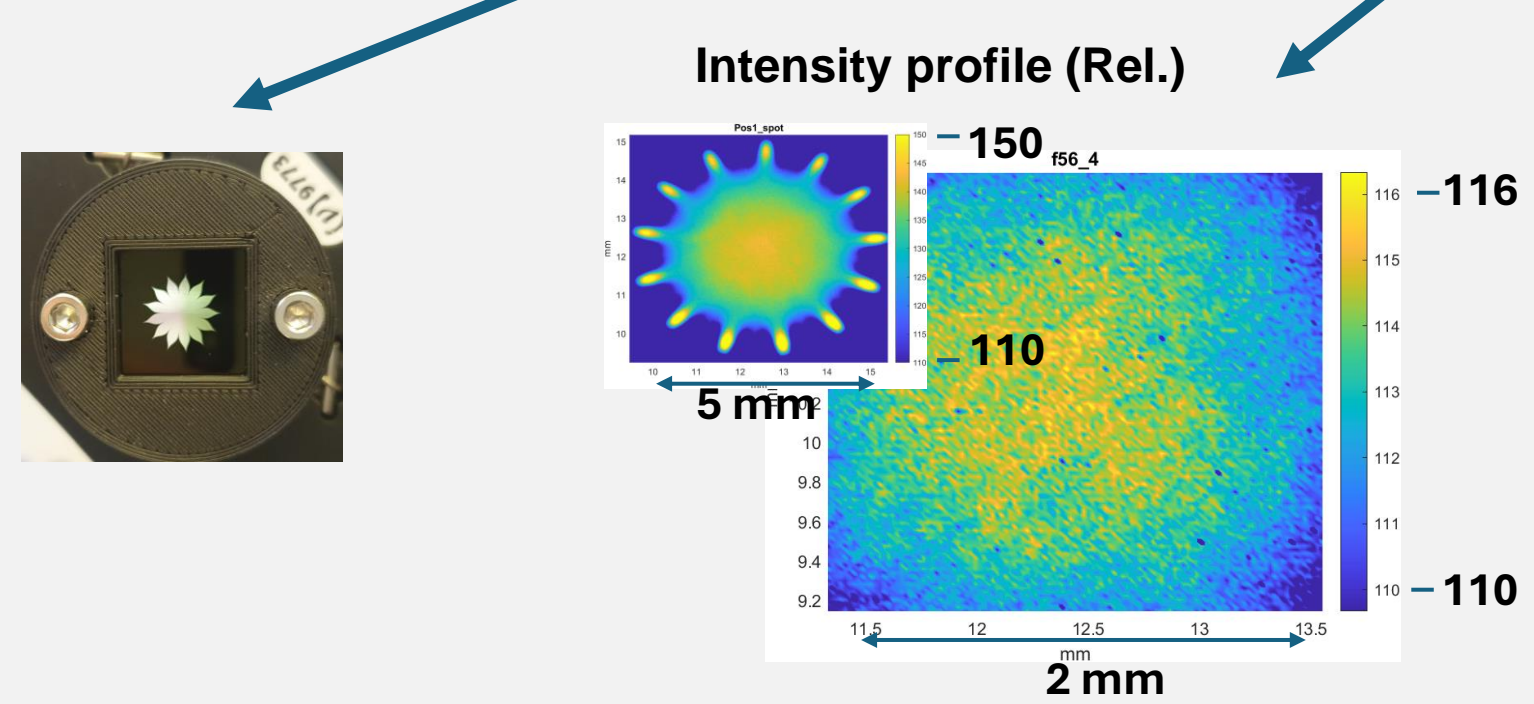

Results

- Intensity variations < 3 % P.V. over 3 mm
- rms. intensity variations < 1% rms
- Wavefront error < λ/100 rms (1064 nm)

→ Associated TTL < 0.1 μm/rad

Beam position Ctrl

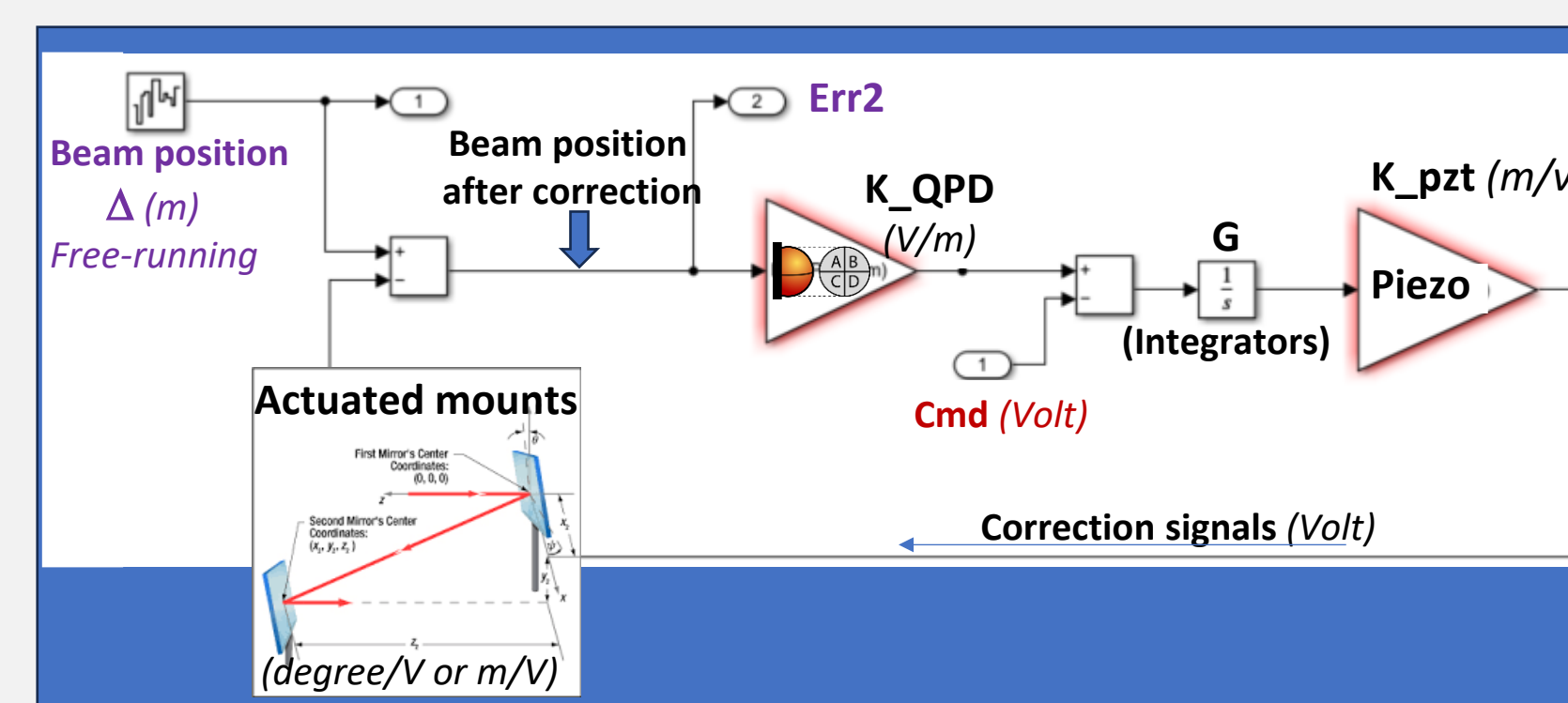

$$Err2 = \Delta / OLTf + Cmd / K_QPD \approx Cmd / K_QPD \text{ with } OLTf \gg 1$$

- « Err2 »: in-loop error signal
- OLTF = $G \cdot K_pzt \cdot K_QPD$, Open Loop Transfer Function
- OLTF ∝ 150/f, f: the Fourier frequency
- $K_QPD \propto P/w$, w: beam waist, P: Laser power
- « Cmd »: Electronic setting

Results

- Beams position (shift & Tilt) locked at (all 3 conjugated)
- Beams tilt & shift: fine Cmd added to the servo loop error signals

→ Submicrometric & fast alignments (< 60 sec) at

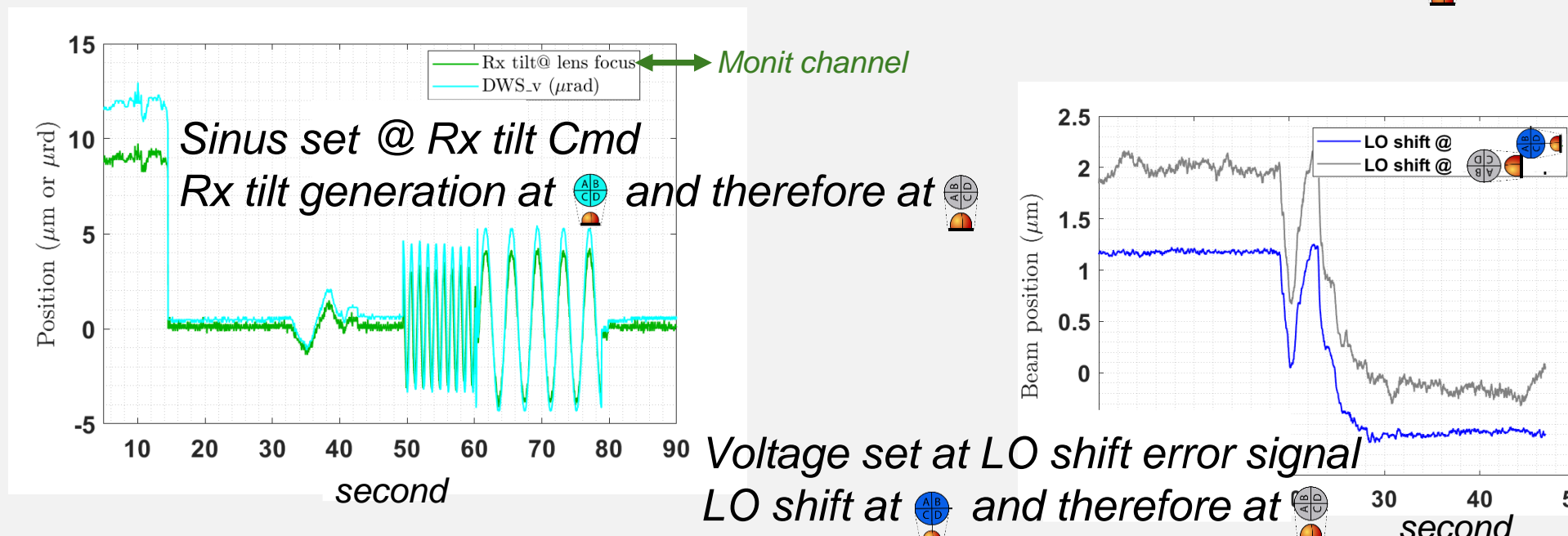

Opto-mechanical mounts stability *

Invar-based design

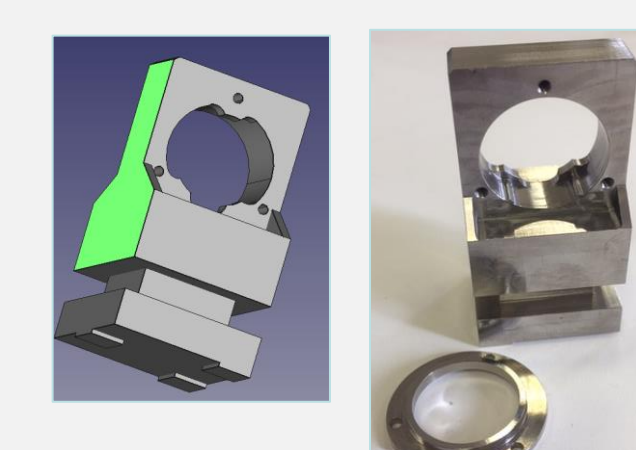

* Measured with SIOS triple laser interferometer

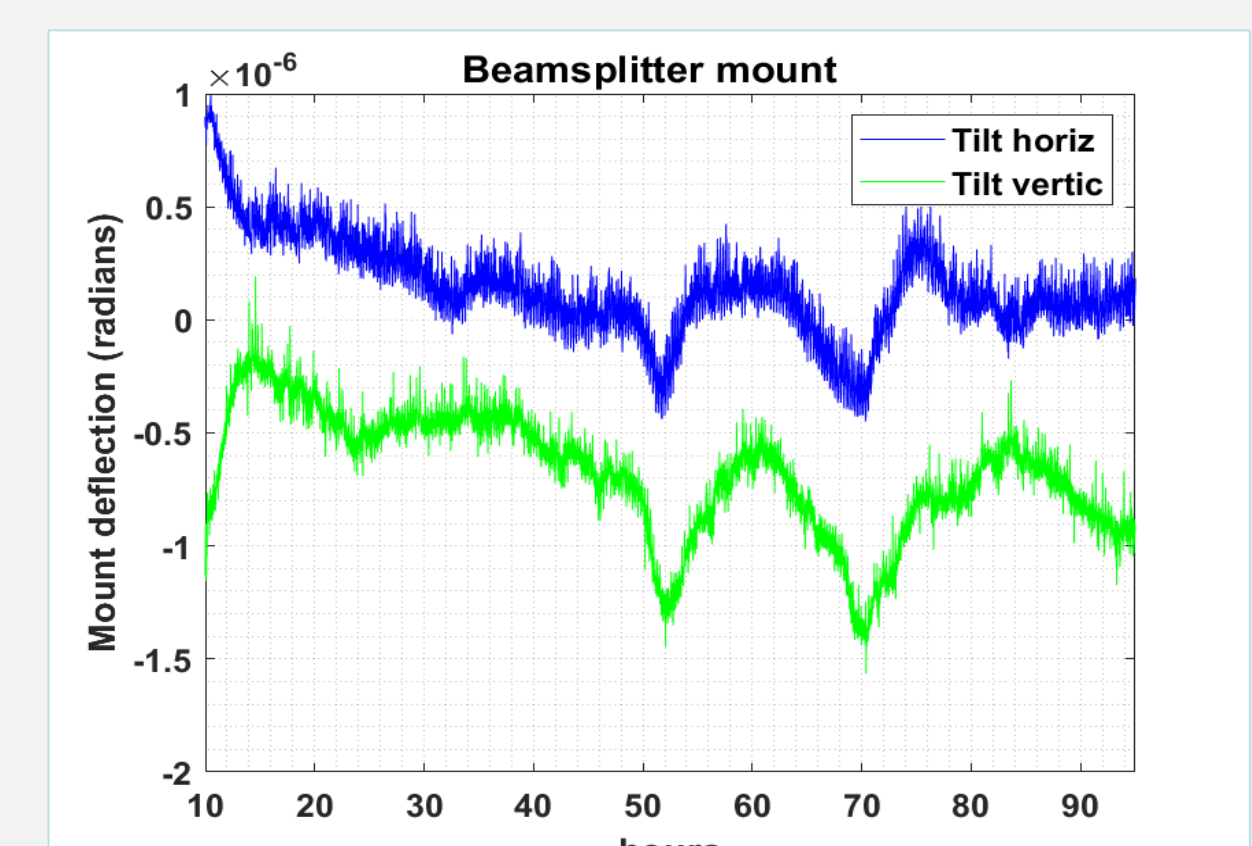

ie 1 μm beam drift @ pupil (assuming ≈ 0.25 m lever arms)

VII - Conclusion

- TTL_{Meas.}⁵ accuracy < 5 μm/rad
- TTL_{Meas.}⁵ drifts < 1 μm/rad, 130 h run
- Std(TTL_{Meas.}⁵, 60 s. data trends) < 10⁻⁷ m/rad, 130 h run

→ Compliant with the FOGOB specifications

- Sub-micrometric and straightforward beam alignments
- Operated with off-the-shelf components, in a « standard » Laboratory environment

- Missing
 - Flattop integration
 - TTL meas. @ output pupil

⁽⁵⁾ measured at the "Rx-to-LO" QPD, rather than at the output pupil

