



**HAL**  
open science

## Centrifuge eccentric loading of square foundation over rigid inclusions with the 4 Degree Of Freedom robot

Luc Thorel, Matthieu Blanc, Alain Neel, Alexandre Jagu, Philippe Audrain, Patrick Gaudicneau, Stéphane Lerat

### ► To cite this version:

Luc Thorel, Matthieu Blanc, Alain Neel, Alexandre Jagu, Philippe Audrain, et al.. Centrifuge eccentric loading of square foundation over rigid inclusions with the 4 Degree Of Freedom robot. 5th European Conference on Physical Modelling in Geotechnics - ECPMG 2024, Deltares; TU Delft, Oct 2024, Delft, Netherlands. 5p., 10.53243/ECPMG2024-62 . hal-04737842

**HAL Id: hal-04737842**

**<https://hal.science/hal-04737842v1>**

Submitted on 15 Oct 2024

**HAL** is a multi-disciplinary open access archive for the deposit and dissemination of scientific research documents, whether they are published or not. The documents may come from teaching and research institutions in France or abroad, or from public or private research centers.

L'archive ouverte pluridisciplinaire **HAL**, est destinée au dépôt et à la diffusion de documents scientifiques de niveau recherche, publiés ou non, émanant des établissements d'enseignement et de recherche français ou étrangers, des laboratoires publics ou privés.

# Centrifuge eccentric loading of square foundation over rigid inclusions with the 4 Degree Of Freedom robot

L. Thorel, M. Blanc, A. Neel, A. Jagu, Ph. Audrain, P. Gaudicheau, S. Lerat

University Gustave Eiffel, GERS-CG, Nantes, France, [luc.thorel@univ-eiffel.fr](mailto:luc.thorel@univ-eiffel.fr), [matthieu.blanc@univ-eiffel.fr](mailto:matthieu.blanc@univ-eiffel.fr),  
[alain.neel@univ-eiffel.fr](mailto:alain.neel@univ-eiffel.fr), [alexandre.jagu@univ-eiffel.fr](mailto:alexandre.jagu@univ-eiffel.fr), [philippe.audrain@univ-eiffel.fr](mailto:philippe.audrain@univ-eiffel.fr),  
[patrick.gaudicheau@univ-eiffel.fr](mailto:patrick.gaudicheau@univ-eiffel.fr), [stephane.lerat@univ-eiffel.fr](mailto:stephane.lerat@univ-eiffel.fr)

**ABSTRACT:** The load eccentricity effect of a square foundation resting on 4 Rigid Inclusions is investigated with small-scale centrifuge models. 3 tests were performed on instrumented models with the robot of Uni Eiffel Centrifuge laboratory. The details of the experiment, as well as the kinematics of the foundation and the load transfer towards the Rigid Inclusions via a granular Load Transfer Platform, are presented.

## 1 INTRODUCTION

Within the French National Project ASIRI+ (<https://asiriplus.fr>), devoted to the reinforcement of soft soils by Rigid Inclusions (RI), the behaviour of a square foundation (SF) on four RIs is studied with centrifuge small-scale models. This “composite foundation” includes, from top to bottom in Figure 1: 1) a SF; 2) a granular Load Transfer Platform (LTP); 3) deep foundations (RIs) installed in a soft clay; 4) a sand layer where the RI tips penetrate. The forces transmitted to the RIs and the kinematics of the SF are presented here, for three different eccentricities.

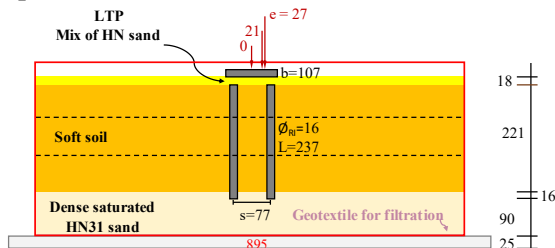

Figure 1. Cross section of the composite foundation in the circular container tested in the centrifuge (in mm).

## 2 EXPERIMENTAL SETUP

The experiments were inspired from the geometry of field tests (Briançon *et al.*, 2000). The scaling laws (e.g. Garnier *et al.*, 2007) applied for designing the tests led to a scale of 1/16.9, inducing a g-level of  $N=16.9$ . The results are presented at model scale.

The soil mass included, from the bottom to the top: 1) a filtration geotextile; 2) a dense saturated Hostun HN31 sand; 3) the soft soil, prepared in three layers with a loading programme adapted to a slightly over consolidated clay, was made of a mixture of kaolin clay and Fontainebleau sand NE34 (Baudouin, 2010); 4) the LTP, made of dense well-graded Hostun sand mixture (Baudouin *et al.*, 2008).

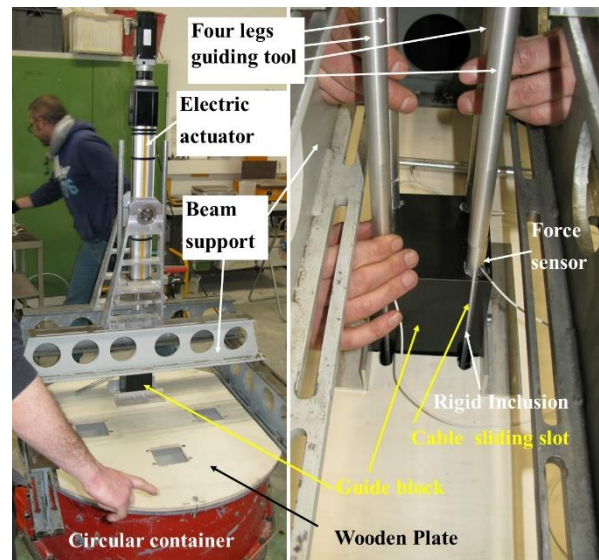

Figure 2. Guiding system for RI's installation.

The instrumented RIs were installed in the lab (Figure 2). A wooden plate with pre-open square windows was fixed on the circular container, together with a set of four beams. The wooden plate supports the guide block, that was moved from one window to another, corresponding to up to four locations of a SF on RI. The beams supported an electric actuator used to drive the RIs with a four legs rigid guiding tool passing through the fixed guide block (in black). All the RIs of one location are carefully simultaneously driven at a speed of 1mm/min.

The model foundation was made of aluminium (Figure 3), as well as the instrumented RIs (Figure 4). The SF included an upper part, with a T-shape, used to be hanged and downward loaded by the robot: the loading point (Figure 5) may be centred or shifted by 21 or 27mm, generating a main rotation around the x-axis (Figure 1, Figure 3).

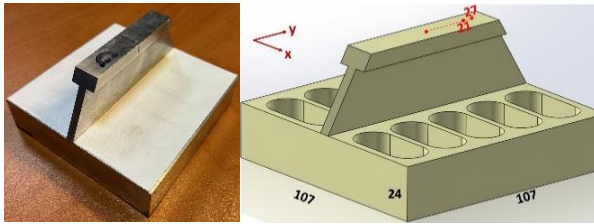

Figure 3. Square foundation small-scale model

A (white) scotch tape was glued on the top surface. The RIs were instrumented with a force sensor securely attached to the top surface cap (Figure 4).

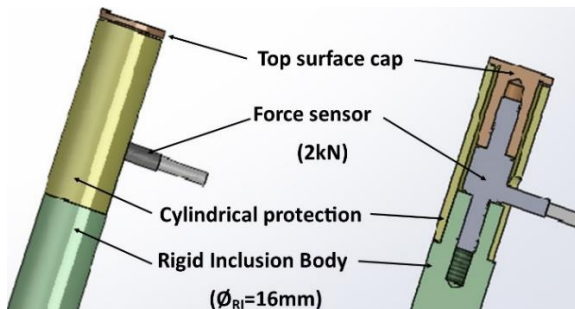

Figure 4. Drawings of Instrumented Rigid Inclusion

To optimise the clay consolidation time in centrifuge, four tests were performed during the same centrifuge flight, thanks to the Uni Eiffel Robot (Gaudicheau et al., 2014). A special robot tool was developed for the foundation carriage and loading (Figure 5). The 4 foundations are stored on a board fixed on the container, and are installed on the expected location (where the RIs have been pre-installed) before being loaded (Figure 6).

### 3 EXPERIMENTAL PROGRAMME

All centrifuge tests were performed in the same circular container, with an LTP height of 18mm (0.3m in prototype scale), and with 3 eccentricities  $e$  reported to the spacing  $s$  :  $e/s = 0, 0.27 \text{ \& } 0.35$  (or to the foundation width  $b$  :  $e/b = 0, 0.19 \text{ \& } 0.25$ ).

After a consolidation phase lasting about 2 hours in flight, the series of foundation loading start. The vertical loading of the foundations was displacement-controlled at a velocity of 1mm/min. For positive eccentricity, the vertical loading generated a negative rotation around the x-axis ( $\theta_x$ ). The data was recorded at a frequency of 10Hz with a HBK Quantum DAS.

The laser sensors installed on the multi-use tool are pointed towards the foundation to access to its rigid body rotation. The distance between the laser rays is 100mm in the x direction and 40mm in the y direction. This induces a better accuracy of the rotation around y-axis ( $\theta_y$ ) than around x-axis ( $\theta_x$ ).

The load tests (Table 1) were devoted to eccentric loading, for investigation the load repartition and the kinematics of the square foundation.

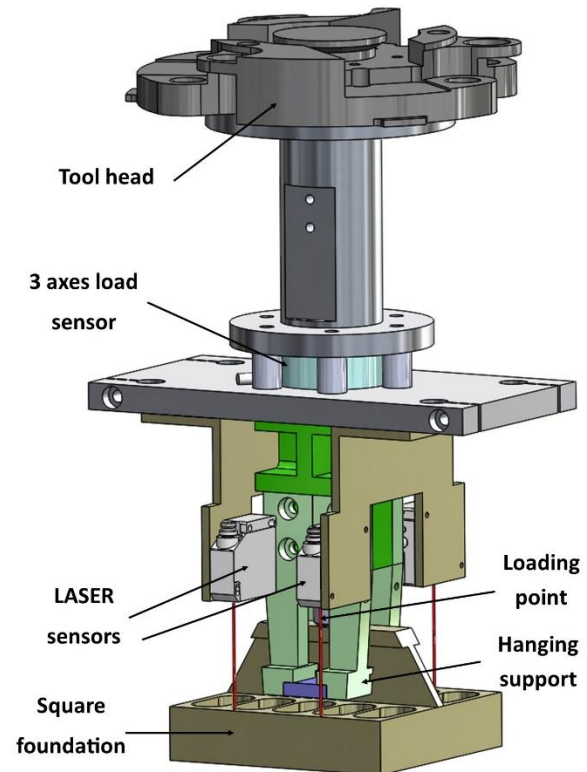

Figure 5. Multi-use tool for the centrifuge robot

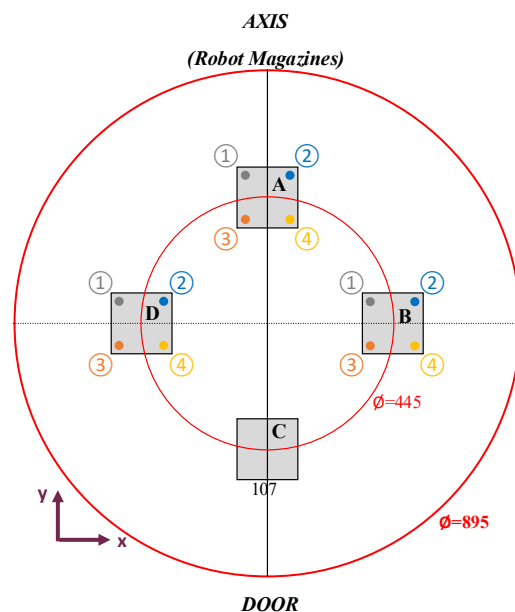

Figure 6. Top view implementation in the container (mm)

Table 1. Load test configuration.

Test	$e/s$	$e$ (mm)	$s$ (mm)	Comment
A	0.35	27	77	
B	0.27	21	77	
C	NA	NA	NA	No loading
D	0	0	77	

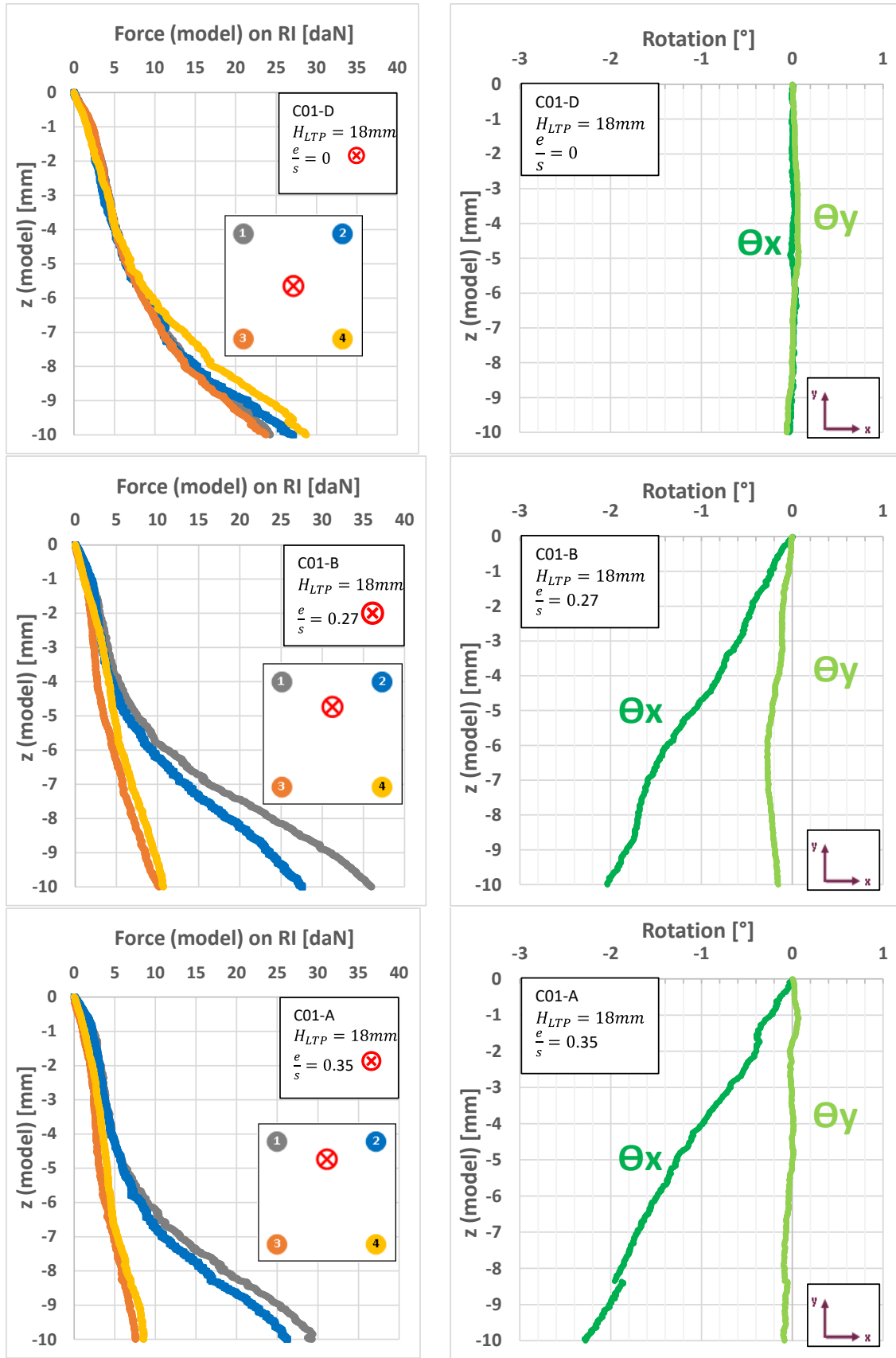

Figure 7. Forces transmitted to the rigid inclusions (left) and rotations (right) versus settlement for 3 eccentricities: 0 (top), 0.27 (middle), 0.35 (bottom)

## 4 DISCUSSION

The results of loading (Figure 7) show the behaviour up to a settlement of  $1/10^{\text{th}}$  of the foundation width (107mm), at model scale.

For the vertical centred load, the loads are almost the same on the RIs until the symmetry is lost, generating a slight rotation towards RI 2 and RI4.

When an eccentric load is applied, the rotation of the foundation is immediately visible. The load transfer towards RIs 1 and 2 is increased after a settlement of few millimeters, showing a complex behaviour that includes first a mechanism inside the LTP and then the mobilisation of the RIs in an asymmetrical way.

It can be observed that, even if a careful process has been followed in the preparation of the soil model, the installation of RIs and the location of the loading points, very small rotations are observed on the  $y$  axis. This shows that there are small uncertainties relative to the loss of symmetry.

When comparing the total load variation applied on the foundation with to the sum of the load variation on RIs (Figure 8), two distinct mechanisms of load transfer may be identified whatever the eccentricity is. The initial slope for small settlements (and loadings) is about 0.38, when the final slope is close to 0.74, showing a progressive mobilisation of the RIs. For a similar settlement of the foundation center (e.g. the end of the curves correspond to the Service Limit State, 10% of the foundation width), loads decrease with the increase of the eccentricity.

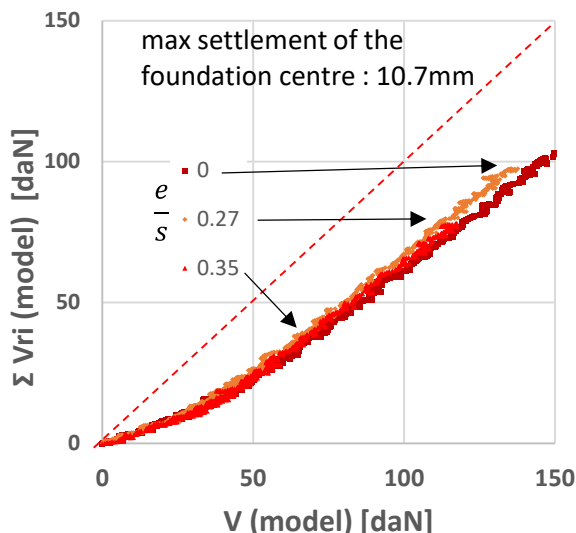

Figure 8. Total force variation applied on the RIs vs the total force variation applied on the foundation.

It can be stated that to reach the same vertical displacement applied on the loading point: 1) stronger force is required for centred load than for eccentric; 2) higher load is transferred to the soft soil

for higher eccentricity. In any case, the load transmitted to the RIs is smaller than the load applied to the foundation, but the ratio does not seem to be affected by the eccentricity.

From Figure 7, it seems that the front RIs (① & ②) behave quite similarly in any case, showing a similar load transfer whatever the eccentricity is. Nevertheless, as the total applied load is not necessarily the same, the intensity of the load transfer appears much higher for eccentric load.

The proportion of the total load transmitted to the rear RIs and the front RIs (Figure 9) displays also two phases : 1) it appears almost equilibrated in the progressive mobilisation of the IR; 2) divergent path are observed, particularly for eccentric loadings that mobilised much more the front pair (① & ②) of RIs.

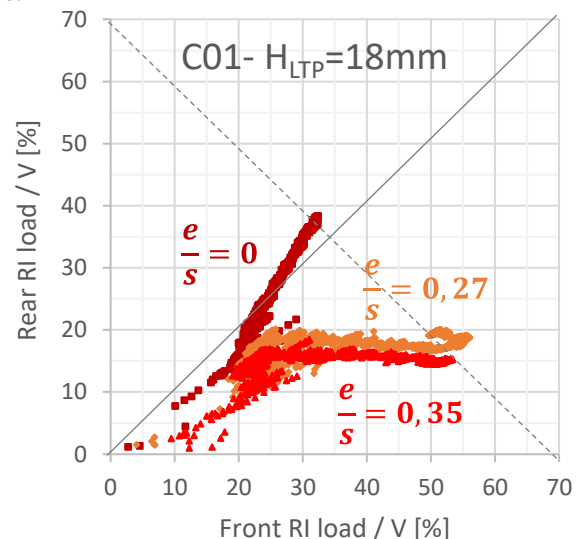

Figure 9. Ratio of the load supported by the two rear RI (③ & ④) by the total load versus the ratio of the load supported by the two front RI (① & ②) by the total load.

## 5 CONCLUSIONS

A series of centrifuge tests have been developed to investigate the eccentricity effect on complex foundation system made of a shallow square foundation resting on four rigid inclusions.

The first results show that for a settlement of 10% of the width of the foundation, the rotation reaches a value of about 2 degrees, and that the front RIs catch three times more load than the rear RIs.

During the loading of each foundation, two mechanisms seem to appear: 1) load transfer mainly in the LTP; 2) a load transfer more active towards the RIs.

Additional investigation is under process for other test configuration such as the LTP height.



## ACKNOWLEDGEMENTS

The authors are grateful for the financial support provided by the French National Project ASIRI+.

## REFERENCES

- Briaçon, L., Bohn, C. and Szymkiewicz, F. (2020). Semelles sur inclusions rigides – Plan d’auscultation. Rapport PN ASIRI+, tâche 4, T4-04, ASI+/R/001, 15p.
- Baudouin, G., (2010). Modélisation Physique en centrifugeuse des sols renforcés par Inclusions rigides, Ph.D. Univ. Nantes.  
<https://www.theses.fr/2010NANT2046>
- Baudouin G., Rosquoët F., Canou J., Dupla J.C., Thorel L., Rault G. and Andria-Ntoanina I. (2008). Caractérisation mécanique d’un mélange de sables d’Hostun. J. Nat. Géotech. Géol. Ing., Nantes 18-19 juin JNGG08. ISBN 9782720825204. pp 491-498.  
<https://www.geotech-fr.org/download.php?type=pdf&doc=jngg-2008>
- Garnier, J., Gaudin, C., Springman, S.M., Culligan, P.J., Goodings, D., König, D., Kutter, B., Phillips, R., Randolph, M.F. and Thorel, L. (2007). Catalogue of scaling laws and similitude questions in geotechnical centrifuge modelling. *Int. J. Phys. Mod. Geotechnics* 7(3), 1-24. [doi.org/10.1680/ijpmg.2007.070301](https://doi.org/10.1680/ijpmg.2007.070301)
- Gaudicheau, P., Thorel, L., Néel, A., Audrain, Ph., Lozada, C. and Monroy, J. (2014). Improvement of the IFSTTAR robot control system, 8<sup>th</sup> ICPMG Int. Conf. Phys. Mod. Geotech., Perth 14-17 jan., pp.221-226.

# INTERNATIONAL SOCIETY FOR SOIL MECHANICS AND GEOTECHNICAL ENGINEERING



*This paper was downloaded from the Online Library of the International Society for Soil Mechanics and Geotechnical Engineering (ISSMGE). The library is available here:*

<https://www.issmge.org/publications/online-library>

*This is an open-access database that archives thousands of papers published under the Auspices of the ISSMGE and maintained by the Innovation and Development Committee of ISSMGE.*

*The paper was published in the proceedings of the 5th European Conference on Physical Modelling in Geotechnics and was edited by Miguel Angel Cabrera. The conference was held from October 2<sup>nd</sup> to October 4<sup>th</sup> 2024 at Delft, the Netherlands.*

*To see the prologue of the proceedings visit the link below:*

<https://issmge.org/files/ECPMG2024-Prologue.pdf>