



HAL
open science

Fibre Optic-Based Patch Sensor for Crack Monitoring in Concrete Structures

Yago De Souza Gomes, Mohamed Saidi, Anna Lushnikova, Olivier Plé

► **To cite this version:**

Yago De Souza Gomes, Mohamed Saidi, Anna Lushnikova, Olivier Plé. Fibre Optic-Based Patch Sensor for Crack Monitoring in Concrete Structures. *Strain*, 2024, 60 (6). hal-04734100

HAL Id: hal-04734100

<https://hal.science/hal-04734100v1>

Submitted on 13 Oct 2024

HAL is a multi-disciplinary open access archive for the deposit and dissemination of scientific research documents, whether they are published or not. The documents may come from teaching and research institutions in France or abroad, or from public or private research centers.

L'archive ouverte pluridisciplinaire **HAL**, est destinée au dépôt et à la diffusion de documents scientifiques de niveau recherche, publiés ou non, émanant des établissements d'enseignement et de recherche français ou étrangers, des laboratoires publics ou privés.

Public Domain

Fibre Optic-Based Patch Sensor for Crack Monitoring in Concrete Structures

Yago de Souza Gomes, Université Savoie Mont Blanc, LOCIE, CNRS UMR 5271, INES, Le Bourget du Lac, France, yago.de-souza-gomes@univ-smb.fr

Mohamed Saidi, Université Savoie Mont Blanc, LOCIE, CNRS UMR 5271, INES, Le Bourget du Lac, France, mohamed.saidi@univ-smb.fr

Anna Lushnikova, Université Savoie Mont Blanc, LOCIE, CNRS UMR 5271, INES, Le Bourget du Lac, France, anna.lushnikova@univ-smb.fr

Olivier Plé, Université Savoie Mont Blanc, LOCIE, CNRS UMR 5271, INES, Le Bourget du Lac, France, olivier.ple@univ-smb.fr

Abstract: In the context of the **necessity** to monitor civil engineering structures for accident prevention, this paper presents the performance of an innovative optical fibre patch sensor that can be embedded or glued on the concrete's surface. **The sensor is composed** of a fabric **comprising** an optical fibre network. When **employed** in concrete structures, **it is capable of** detecting opening cracks in the order of 0.01 mm, thereby satisfying the regulatory standards **for** limit states (Eurocode2). **This sensor is capable of** accurately tracking the evolution of crack, including cyclic changes, by sensing both **the** increase and decrease **in crack width**. The procedure outlined in this paper includes a preliminary investigation into the influence of fibre diameter and density within the patch, **which has revealed that fibres of 750 μm in diameter exhibit optimal performance**, as well as the attachment method to concrete surfaces. Subsequently, the process of calibration is detailed, followed by numerous laboratory tests that were conducted on reinforced concrete samples of varying sizes. Comparisons and validations of optical fibre patch sensor measurements were performed using Digital Image Correlation, **resulting in a sensitivity of the sensors reaching 0.01 mm/K, and an accuracy ranging between 0.1% and 1%**. The discussion within this paper considers the installation of this new sensor both externally and internally within real reinforced concrete structures.

Keywords: embedded sensors; structural health monitoring (SHM); optical fibre sensors; crack detection; sensing technologies.

33 Introduction

34 The monitoring of reinforced concrete structures is becoming an increasingly crucial aspect
35 of structural engineering. A variety of techniques for structural health monitoring, including
36 fibre optic, piezoelectric, electrochemical, wireless and self-sensing technologies, with the aim
37 of enhancing the reliability and the safety of concrete infrastructures as well as extending their
38 operating lifespan [1]. Although reinforced concrete structures offer numerous advantages,
39 including strength and durability, they frequently encounter a range of events that accelerate
40 deterioration. These include earthquakes, heavy rainfall, hurricanes, freezing and heating,
41 erosion, abrasion, chemical attacks, changes in the use of the structure that results in unexpected
42 loads, and other factors. These events can collectively reduce the service lifespan of concrete
43 structures and can induce significant safety risks on the structure. The real-time assessment of
44 structural performance, considering both the ultimate and serviceability limit states, facilitates
45 the early detection of anomalies such as defects or damage. This information aids in decision-
46 making process concerning the rehabilitation, reinforcement, and/or destruction/reconstruction
47 of the structure. [2].

48 A concrete structure is considered durable if it is able to provide the desired service life in
49 its environment without incurring excessive maintenance and repair costs due to degradation.
50 When engineers specify concrete for a project, they must consider the potential for deterioration
51 that could affect the concrete in the specific environment over its intended service life. It is
52 essential that the specifications encompass both the generic requirements for the desired class
53 of concrete and specific measures to mitigate or prevent the effects of deteriorative influences
54 at the project site [3].

55 The aging and deterioration of concrete structures is frequently evidenced by the
56 emergence of cracks. These cracks frequently characterise damage to concrete structures in
57 addition to other structural materials [4]. They can have a considerable impact on the structural
58 integrity of the affected structures. In addition to compromising the overall strength and load-
59 bearing capacity of the structure, such cracks also heighten the vulnerability to moisture and
60 chemical penetration, particularly in the case of steel bars. In order to assess the risk associated
61 with cracks in concrete structures, a commonly used diagnostic criterion is the crack width
62 threshold. This threshold serves as an indicator of the severity of the crack and aids in
63 determining the appropriate course of action. The specific crack width threshold varies
64 depending on the type of structure and its intended purpose. In certain instances, Eurocode 2
65 considers a crack width threshold of approximately 0.2 mm as acceptable. However, in
66 scenarios such as liquid retaining structures, this recommended crack width limit can be as low

67 as 0.05 mm [5,6]. This indicates that cracks below this threshold are typically categorised as
68 hairline cracks and are deemed to have minimal impact on the performance and durability of
69 the structure. However, cracks exceeding this threshold have the potential to impair the proper
70 functioning or durability of the structure or cause its appearance to be unacceptable, requiring
71 a more detailed examination.

72 The term “Structural Health Monitoring” (SHM) was defined by Villalba S and Casas J
73 (2013) [7] as a set of strategies for the continuous or regular measurement and analysis of key
74 structural and environmental parameters under operating conditions, for warning of abnormal
75 states or accidents at early stages. Historically, the assessment of civil engineering
76 infrastructures relied on periodic visual inspections conducted by trained professionals and
77 sometimes completed with measurements [8]. However, this method could result in diagnostic
78 errors due to imprecise interpretations by engineers leading to direct or indirect conclusions
79 about factors such as displacement, strain, humidity, temperature, and other technical data taken
80 punctually and not continuously. Currently, there are different ways to determine the stress state
81 of a concrete structure [9], and for detecting cracks on concrete surfaces or within concrete
82 structures [10–12]. There is a growing tendency towards the adoption of more intelligent
83 surveillance techniques, characterised by remote monitoring in real time and the generation of
84 automatic reports and alert systems. Deformation sensors play a crucial role in this context [9].

85 Fibre Optic-based strain sensors have emerged as a highly promising solution, significantly
86 advancing the field of structural health monitoring. Despite the existence of traditional and well-
87 established deformation sensors, such as strain gauges, linear variable differential transducers
88 (LVTD) or vibrating wire strain gauges, the fibre optic (FO) sensors offer several advantageous
89 properties. These include their light weight, electromagnetic passiveness and flexible
90 installation. Over the past few decades, these sensors have been increasingly employed in civil
91 engineering structures, enabling measurements over extensive lengths, exclusively along the
92 optical fibres’ direction. Depending on the installation setup, they can also access a 2D strain
93 field [13,14]. Furthermore, some FO-based technologies are capable of measuring
94 displacements with unparalleled precision [15–17].

95 Among the technologies that are based on fibre optics, some can be highlighted. One such
96 example is the Fabry-Pérot interferometer sensor, which is a discrete sensor in which the
97 measurement principle relies on a cavity, also called the Fabry-Pérot cavity, that separates two
98 segments of uniaxial optical fibres. The configuration of a single mirror on either side of the
99 cavity enables the differentiation of the rays emanating from the initial mirror and the
100 subsequent mirror, thus facilitating the calculation of the distance between the two mirrors. This

101 distance can be a function of different phenomena [18,19]; The fibre Bragg grating sensor is a
102 spot sensor that can be multiplexed to transform into a quasi-distributed sensor. It has been
103 employed as a very effective tool for the monitoring of structures' health. The operational
104 principle is based on the reflection of a specific wavelength spectrum by a grating situated in
105 the core of the fibre. This consists of invisible periodic refractive index alterations which will
106 result in a shift of the wavelength when subjected to deformation [20–25]. Another notable
107 technology is the distributed optical fibre sensor (DOFS), which predominantly employs
108 Rayleigh, Brillouin or Raman backscattering for the detection of vibration, strain and
109 temperature variations. One of the most effective technologies is optical time-domain
110 reflectometry (OTDR), which functions by transmitting highly coherent probe pulses and
111 collecting Rayleigh backscattered (RBS) light to detect dynamic perturbation along the sensing
112 fibre. These sensors are capable of continuous monitoring along the entire length of the fibre,
113 over distances of up to several kilometres [26–28].

114 While each technique has its own set of advantages, it is important to acknowledge the
115 limitations associated with each. Some of these limitations include cost, vulnerability to signal
116 attenuation, a complex calibration process, a limited strain measurement range, and a complex
117 fabrication process [29]. It is for these reasons that this project can be considered a valid and
118 promising solution in the field of innovative sensors.

119 This work presents a novel fibre optic-based sensor, which can be embedded in concrete
120 or attached to its surface, and analysis its performance. The sensor is comprised of a textile
121 where fibres are woven parallel to each other, intercalating fibres connected to a light source
122 and fibres connected to a photosensitive dispositive that provides accurate Correlated Colour
123 Temperature (CCT), expressed in Kelvin (K). The signal is then obtained by the rays which
124 escaped from the emitting fibres and entered the receiving fibres due to intentional creation of
125 surface irregularities. The detailed attributes of this optical patch sensor are outlined in French
126 Patent No. 3067806, officially registered under No. 1755382 [30].

127 The embedded and on-surface patch sensors will be discussed in turn. The sensor is capable
128 of detecting opening cracks as small as 0.01 mm, within the regulatory limits. The sensor is
129 capable of tracking the progression of the crack, detecting both widening and narrowing. The
130 capacity to sense crack closure is crucial, especially given recent advancements in crack
131 repairing techniques.

132 **Methods**

133 **Components description**

134 **Light detector**

135 **The** SENTMI (SENsor Textile Monitoring Infrastructures) project **utilises**, in its first version,
136 a white LED OSOLON SSL 150 “GW CSHPM1” (

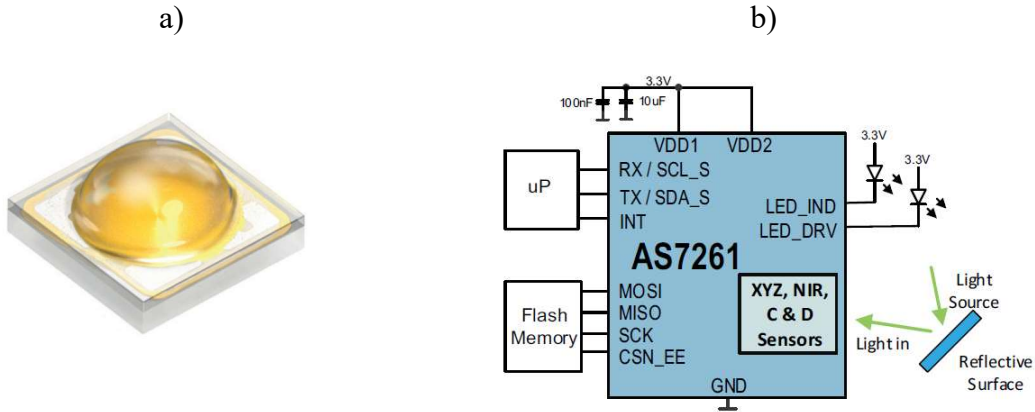

137
138 Fig 1-a) and the AS7261 sensor from ams OSRAM, which is a chromatic white colour sensor
139 that provides XYZ colour coordinates consistent with the CIE ("*Commission Internationale de*
140 *l'éclairage*") colour space as well as the Near Infra-Red (NIR) spectrum (

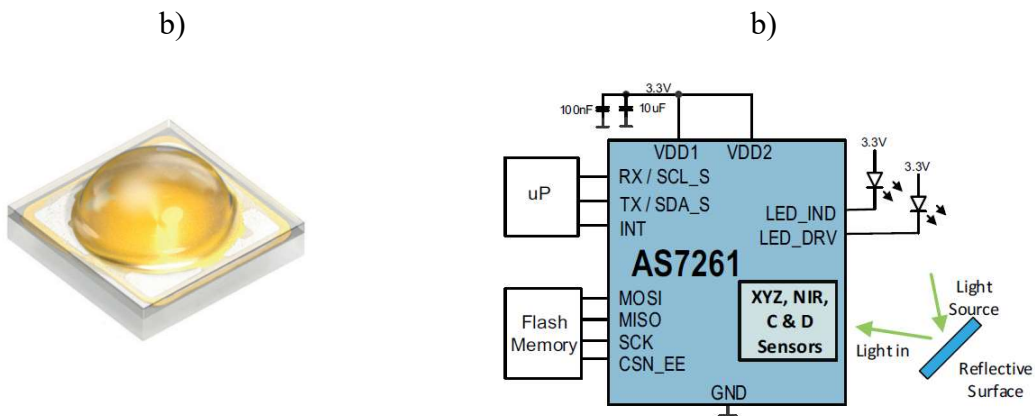

141
142 Fig 1-b). The spectral conversion is applied via two photodiode banks. Bank 1 converts data
143 from the X, Y, Z and NIR photodiodes. Bank 2 **processes** data from the same X and Y
144 photodiodes as well as the D (dark) and C (clear) photodiodes [31].

145
c) b)

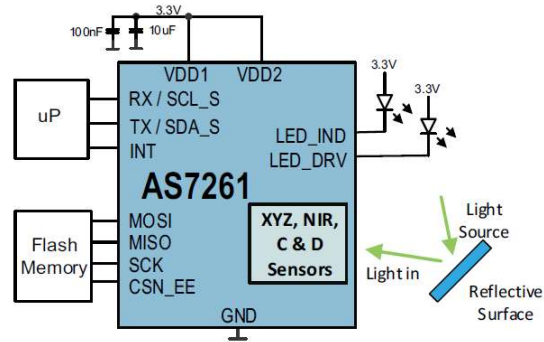

146

147

Fig 1. a) sensor's LED; b) AS7261 Chromatic White Color System

148

149 **Textile sensor**

150

An elastane fabric incorporates **PMMA-based** optical fibres that are woven in a parallel configuration. In the active zone (Fig 2), a technique of damage is employed to create intentional flaws on the surface of the FO cladding and on the interface between the FO core and cladding. This **allows the passage of light to adjacent fibres**. There are two groups of optical fibers. Emitting fibers are the ones connected to the white LED, while the receiving fibers are the ones connected to the AS7261. Those two groups of fibers are arranged **in an intercalated configuration**. **The portion** of the fibers that **is not situated within** the active **zone is not subjected to the** damaging technique. **Consequently**, in this portion of the fibers, the light travels **in accordance with** the principle of total internal reflection. This design ensures that the photodiodes **exclusively detect fluctuations in** the correlated colour temperature **resulting from modifications** in the active zone [30]. The diameter of the fibres and the density of fibres **are significant factors influencing the sensitivity of the textile sensor**. The density is defined as the number of fibres per centimetre in the direction denoted as "a" in Fig 2.

162

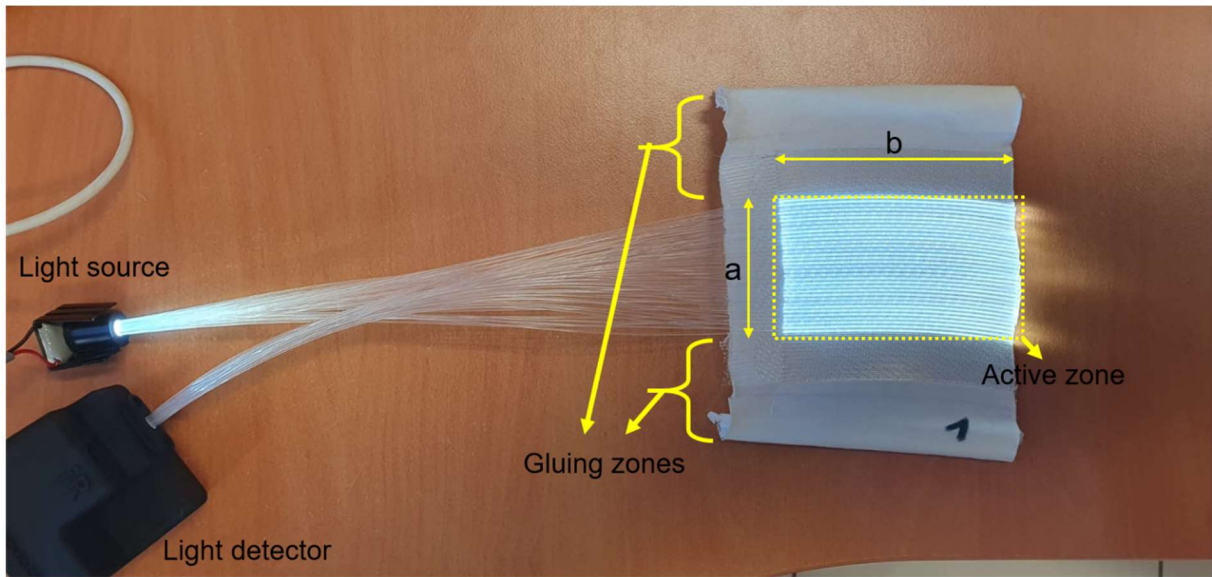
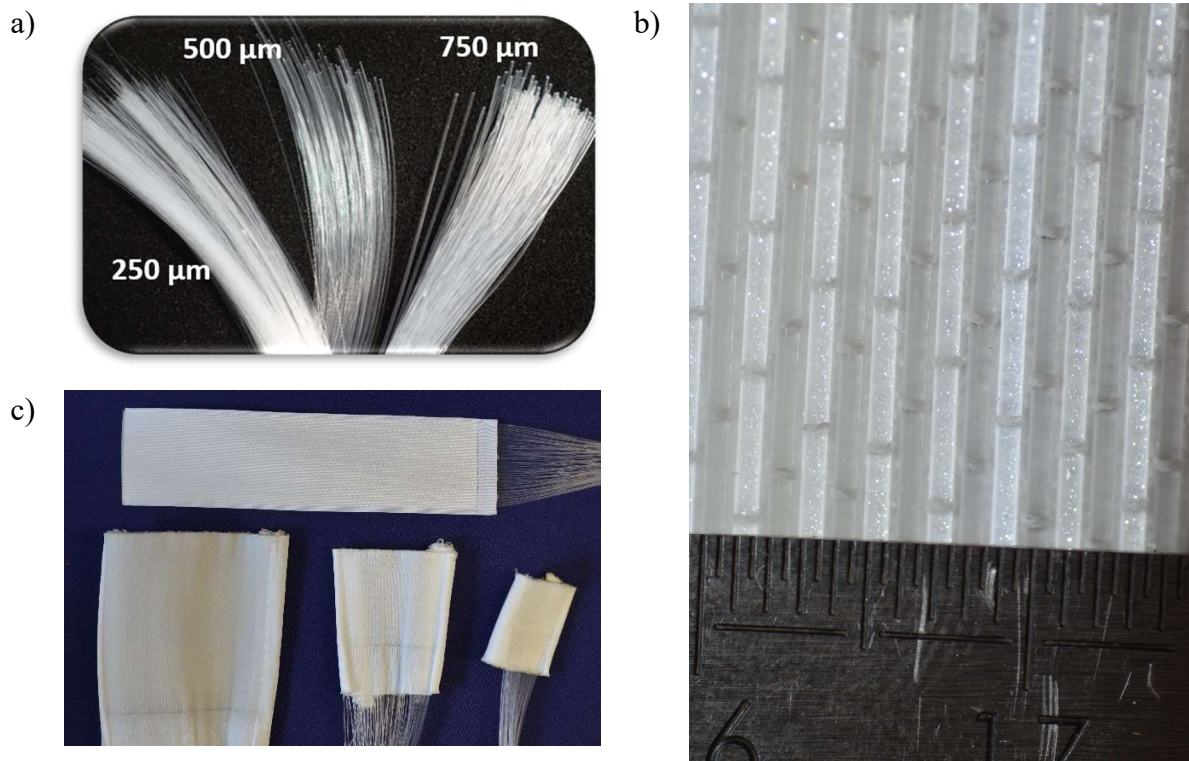

Fig 2. SENTMI fibre optic patch sensor

Parameters of sensor configuration

The optimal configuration for the optical patch sensors was determined by examining a range of parameters, including fibre diameter, fibre density, fabric size, and light power. Fiber diameters ranging from 250 to 750 μm (Fig 3-a) and densities between 7 and 26 optical fibres per cm were utilised for experimentation. Fabric of dimensions $30 \times 30 \text{ mm}^2$, $50 \times 50 \text{ mm}^2$, $50 \times 150 \text{ mm}^2$, and $100 \times 100 \text{ mm}^2$ were employed on different types of concrete samples (Table 1). The findings from assessing the patch's effectiveness in detecting and measuring deformation are presented in this paper.



180 Fig 3. a) diameters used in the study; b) patch featuring 750 fibres connected to the LED; c)
 181 different patch sizes
 182

183 **Table 1.** Configurations of patches preliminary studied

Dimensions a × b (mm ²)	FO	Density (FO/cm)
		7
	250	11.5
		18.5
		26 (max)
100 × 100		7
	500	11.5
		18.5 (max)
	750	7
		11.5 (max)
50 × 150	500	7
		11.5
		18.5 (max)
50 × 50	750	11.5 (max)
	500	18.5 (max)
30 × 30		7
	500	11.5
		18.5 (max)

184
185
186
187
188
189
190
191
192
193
194
195
196
197
198
199
200
201
202
203

The objective was to enhance the sensor configuration, aiming to improve sensitivity. In this context, sensitivity is defined as the amount of displacement between the two edges of the sensor required to alter spectral coordinates by one unit or, equivalently, the amount of global strain needed to change spectral coordinates by one unit.

It was observed that an increase in the selected diameter resulted in a higher light spectrum coordinate and enhanced sensor sensitivity. Following initial observations, the 250 μm diameter was discarded due to its inferior performance in comparison to the other two diameters. A 650% increase in sensor sensitivity was observed between the 250 μm and 500 μm diameter ranges.

The number of fibres per cm also exerts an influence on the signal strength, with denser patches yielding stronger and more sensitive signals (Fig 4). For instance, a 750 μm diameter fiber presented a 16% enhancement in sensor sensitivity when the number of fibres per cm was increased from 7 to 11.5. However, it should be noted that there are limitations to the density of fibres of a given diameter. For example, fibres with a diameter of 750 μm are unable to reach the maximum density achievable with the other two types of fibre.

Considering these parameters, the initial configurations selected for further investigation were fibres with a diameter of 500 μm and a density of 18.5 fibres per cm and fibres with a diameter of 750 μm and a density of 11.5 fibres per cm, representing the maximum density for their respective diameters.

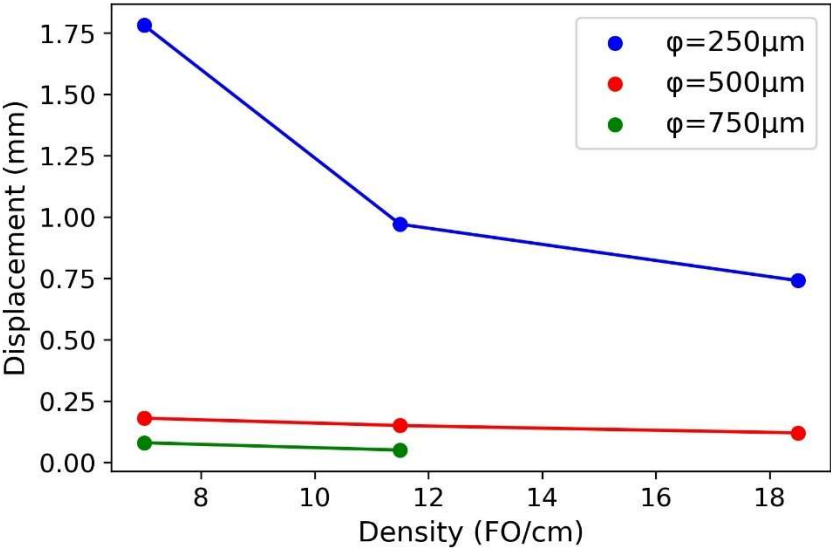

204
205
206
207

Fig 4. Comparison of the displacement needed for varying light signal, depending on the quantity of fibres per cm, for fibres in three different diameters.

208 The dimensions were selected on the basis of their suitability for use in the testing and
209 calibration process. Given the dimensions of the specimens and the clamps employed in the
210 calibration cycles, the 30 × 30 mm and 50 × 50 mm patches were deemed appropriate.

211 *Patch calibration*

212 In order to gain a deeper insight into the manner in which the patch responds to the
213 displacement of its two edges, a calibration procedure was developed using digital image
214 correlation as a means of comparison and validation. The calibration procedure is under the
215 french patent number B256-B-69739 “Décteur de déformation à base de fibres optiques, et
216 procédé de calibration d’un tel détecteur” [32]. A series of patch configurations were subjected
217 to uniaxial tensile tests, utilising a fabric tensile apparatus equipped with textile clamps. The
218 procedure involved testing the patch individually by gripping its edges in a tensile machine
219 (Step 1 from Fig 5), connecting the patch both to the light source and the detector (Step 2 from
220 Fig 5) and subjecting it to cycles of stretching and releasing at a rate of 0.5 mm/min (Step 3
221 from Fig 5) to compute the equation of correlation (Step 4 from Fig 5). Prior to establishing a
222 standard calibration procedure, the tests were conducted to verify the consistency of the patch's
223 response when subjected to repeated stretching. The machine employs an electromechanical
224 system, comprising a movable crossbar connected to the top clamp, which is guided in an up-
225 and-down motion. At first, the movable crossbar (i.e., the clamp) was fixed at a distance from
226 each other that allowed the textile sensor to remain flat but unstretched, thus representing a
227 relaxed configuration. That was regarded as the initial position, defined as zero displacement.
228 Subsequently, the crossbar was displaced by 2 mm in an upward direction, then by 2 mm in a
229 downward direction (returning to the initial position) four times (blue plot in Fig 6-b). The
230 sensor demonstrated excellent reproducibility, producing identical light signal outputs when
231 decreasing CCT during stretching and recovering it upon returning to its initial tension state.
232 This response appeared to follow a linear pattern, until a subsequent test involving a 3 mm
233 displacement (red plot in Fig 6-b) revealed that the decrease CCT for a 3 mm stretch (20 K)
234 was not directly proportional (150%) to the decrease observed during a 2 mm stretch (15 K).
235 Therefore, the response is not strictly linear.

236

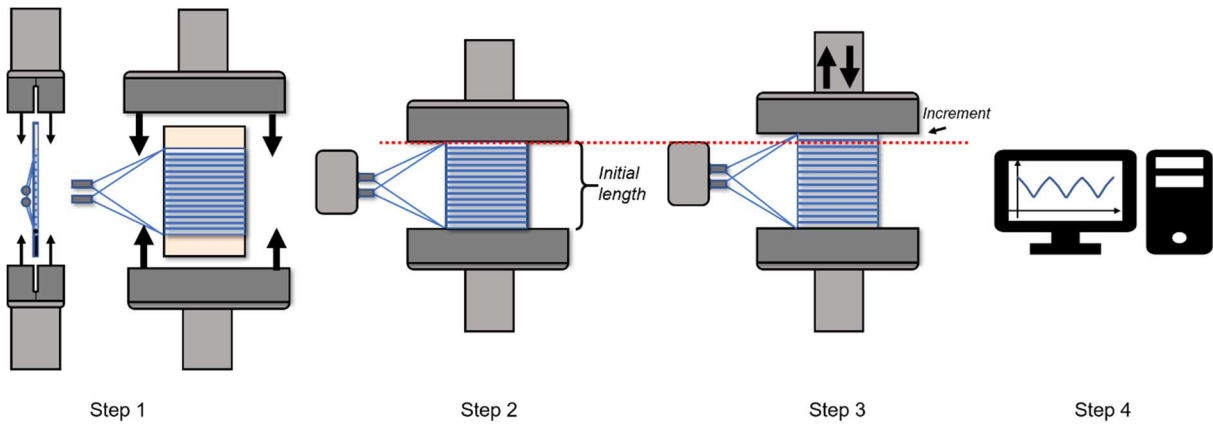

237
238
239
240

Fig 5. Steps for calibrating the SENTMI sensor for measuring cracks

a)

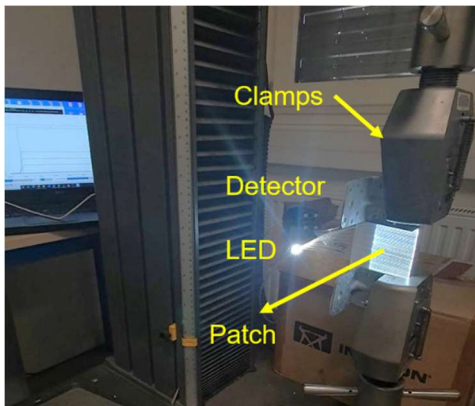

b)

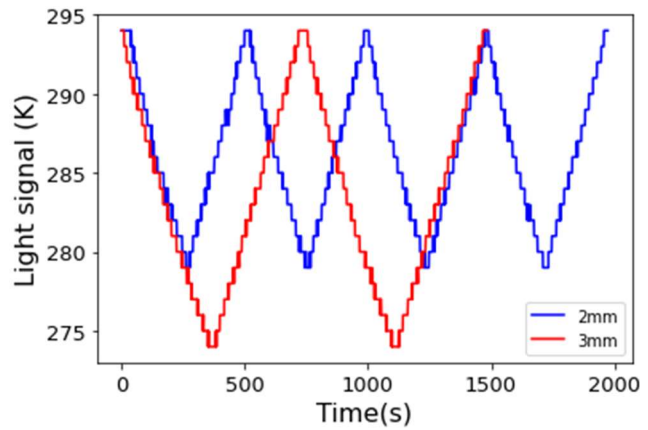

241
242
243
244

Fig 6. Calibration campaign of the SENTMI fibre optic textile sensor: a) SENTMI textile sensor being calibrated; b) Sensor's response to cycles of 2 mm and 3 mm extension and contraction

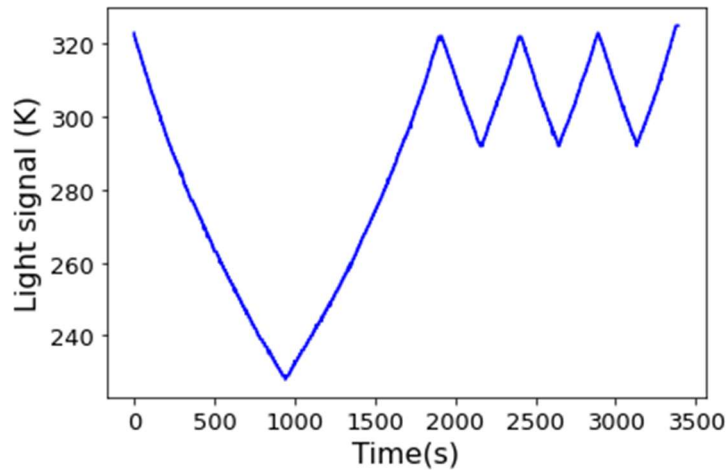

Fig 7. Full cycle of calibration

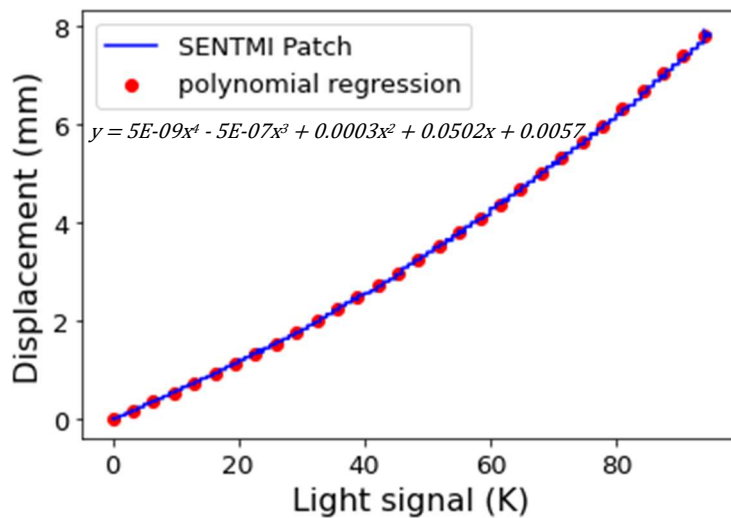

Fig 8. Equation of calibration through polynomial regression.

245
246
247

248
249
250

251 The adopted calibration procedure, which is to be applied to all the patches, consists in
 252 performing one extended stretch of 8 mm, during which the movable crossbar is displaced 8
 253 mm upwards from its initial position. This is followed by a return to the initial position, a further
 254 2 mm stretch, and a return to the initial position, three times (Fig 7). This procedure is
 255 undertaken in order to derive the correlation equation through polynomial regression (Fig 8)
 256 [32]. The post-treatment of the patch signal includes considering the initial value of light signal
 257 as the reference, indicating zero deformation, from which incremental changes can be
 258 calculated. The correlation coefficient, which scales the increment in light signal, represents the
 259 sensitivity of the sensor. For instance, a coefficient of 0.05 mm/K would be applied if each 0.05
 260 mm of stretch corresponds to a variation of 1 unit in light spectrum coordinates. Therefore, this
 261 coefficient can be characterized as:

$$K = \frac{\partial d}{\partial l} \quad (1)$$

262

263 Where K is the coefficient of correlation, d is the displacement of one edge of the patch
 264 with respect to the other edge, and l is the correlated colour temperature.

265 ***Surface attachment method***

266 The patches **have been modified to include additional fabric borders surrounding the area**
 267 **where the glue is applied. In the initial stages of the project**, the glue was applied directly to the
 268 surface of the patch's active zone (Fig 9-a). However, this method was **modified** due to concerns
 269 about potential reinforcement effects on the crack and sliding movements **resulting from** the
 270 interaction of the glue with the patch in the fracture zone.

271 **Consequently**, the adhesive is now applied to the non-active zone of the patch, which is
 272 distant from the crack. This region **is not subjected to** deformation, **thereby** ensuring that the
 273 two zones **remain** independent and **are able to move** with respect to each other.

274

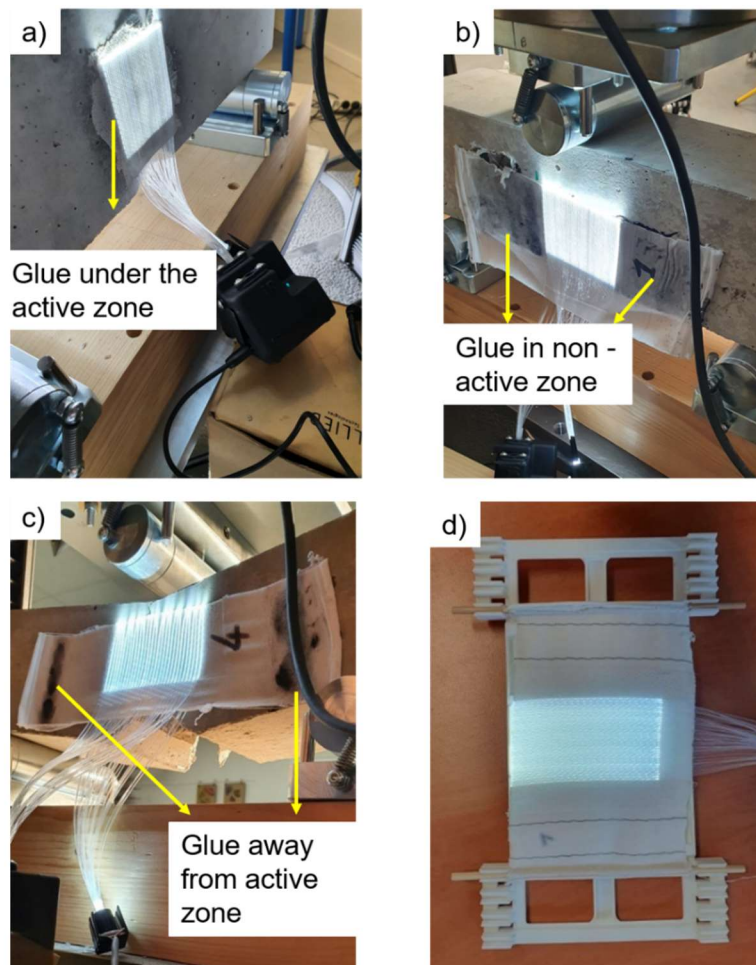

275

276

Fig 9. Methods of gluing the patch to the concrete's surface.

277

278 As the active zone reacts to the displacement between the two glued areas, it's not
279 imperative for the adhesive zone to begin directly from the boundary of the active zone (Fig 9-
280 b), referred to as method 1. Alternatively, the adhesive can be applied at a distance from the
281 active zone, which is called method 2 (Fig 9-c). However, due to the highly deformable nature
282 of the tissue material, the non-active zone between the fibres and the adhesive zones (in Fig
283 10) will absorb a portion of the overall deformation, resulting in an underestimation of the crack
284 width.

285

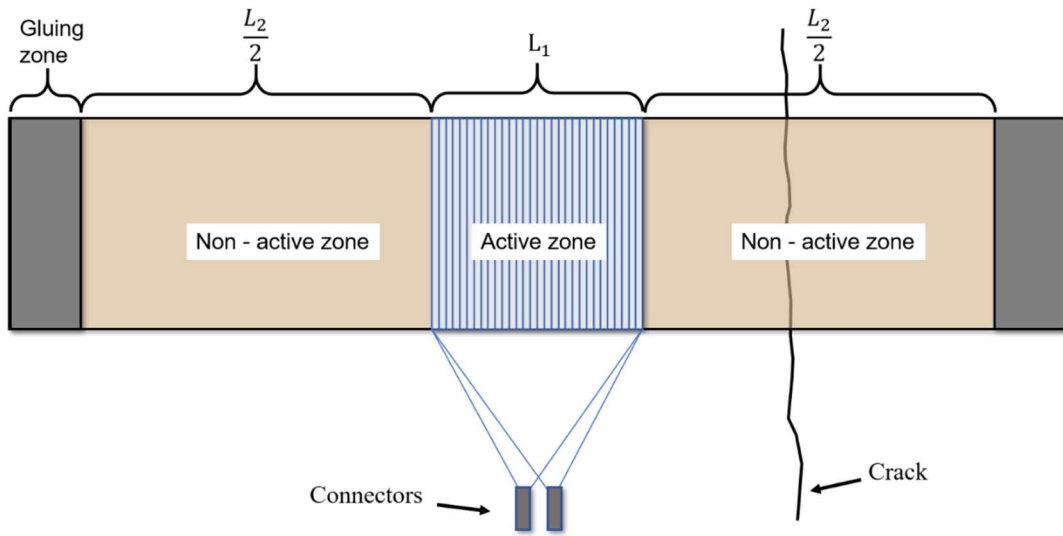

286

287

Fig 10. SENTMI sensor sketch of **method 2**.

288

289 For elastic materials, the ratio between the deformation ΔL and the initial length L_0 ($L_1 +$
290 L_2) is expressed as strain ε as follow:

$$\varepsilon = \frac{\Delta L}{L_0} \quad (2)$$

291

292

293

When an object consists of two materials, a deformation applied to it will result in the deformation of both materials based on their respective moduli of elasticity. The overall deformation ΔL can be expressed in terms of strains and lengths as follows:

$$\Delta L = \varepsilon_1 \cdot L_1 + \varepsilon_2 \cdot L_2 \quad (3)$$

294

295

296

If the modulus of elasticity for and is equal, the increase in length in will be directly proportional to its length in relation to the total length between the two glued zones. This relationship can be presented as:

$$\Delta L_1 = \Delta L \cdot \frac{L_1}{L_1 + L_2} \quad (4)$$

297 This suggests that for a 1 mm crack, it represents 90% of the total length, the active zone
298 will experience a tensile strain of 0.1 mm. Consequently, the sensor exhibits a sensitivity that
299 is ten times lower. However, assuming the non-active zone is completely rigid (experiencing
300 zero strain), this would result in a total stretch of 1 mm in the active zone.

301 The patch illustrated in Fig 9-c was subjected to both gluing methods. The resulting
302 sensitivity was 0.05 mm/K for method 1 and 0.09 mm/K for Method 2. In Method 2, the glue
303 was applied at a distance of 2.5 cm from the edge of the active zone, which has a surface area
304 of $5 \times 5 \text{ cm}^2$. Consequently, in this case, is equal to.

305 The Method 2 offers the advantage that, when the aim is to detect the onset of a crack, it
306 allows for an extension of the sensor's coverage length without requiring additional optical
307 fibres. Conversely, if the objective is to monitor an existing crack, method 1 is preferable.

308 The current gluing method employs an installation device, serving as a frame to ensure
309 standardized patch application (Fig 9-d). As the patch is flexible, manual application without
310 assistance can lead to varying levels of tension. The utilisation of the device ensures a consistent
311 pre-tension. This aspect is crucial, particularly when considering the transition from the
312 laboratory to the construction site. Consequently, the implementation method must be
313 straightforward and systematic in order to minimise the risk of errors.

314 *Embedding method*

315 If the preceding technique is reserved for monitoring existing infrastructures, the patch can
316 also be incorporated into new reinforced concrete structures during construction. Initially, no
317 notches were made on concrete samples where SENTMI textile sensors were utilised (Fig 11-
318 a, Fig 11-b, and Fig 11-c). However, the absence of notches in the samples resulted in the
319 formation of significant crack openings, leading to excessively wide crack widths at the moment
320 of opening compared to the desired values in this study. Consequently, a method was employed
321 to insert the patch into the concrete specimens while still creating the necessary notch (Fig 11-
322 d). Concreting was done by first reaching the level of the bottom of the sensor, ensuring
323 standardized depth. The patch was then installed in conjunction with the prismatic wooden
324 piece that was divided into two parts, to accommodate the patch and secure it at a standard
325 distance from the lateral surface of the samples. The positioning was not centralised. The
326 patches were placed at a distance of 2 cm from one of the lateral surfaces in order to ensure
327 optimal positioning during testing in the flexural testing machine (Fig 12).

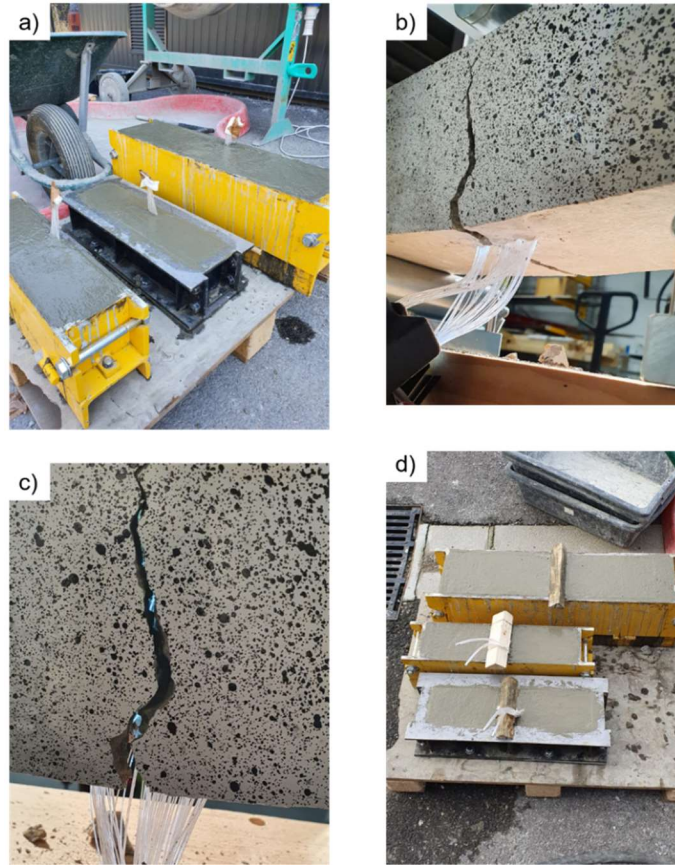

328
329
330

Fig 11. Concrete samples featuring embedded SENTMI textile sensors

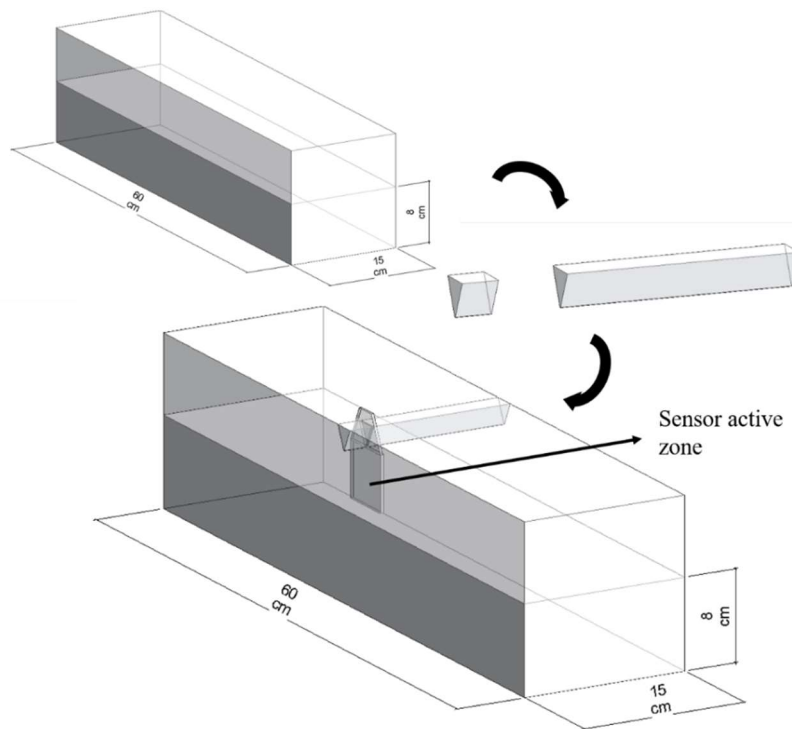

331

332

Fig 12. Method of embedding patch sensor in laboratory concrete samples

333 **Remarks on the difference between on surface and embedded**

334 An important difference between the operating principle of embedded patches and on-
335 surface patches is that, when embedded, only cracks that occur in the active zone will be
336 detected by the patch. The crack, as a discontinuity, occurring outside of the active zone will
337 not result in the deformation of this zone. Moreover, this discontinuity results in the
338 displacement of a limited number of fibres, one to the other, instead of a global strain throughout
339 the active zone.

340

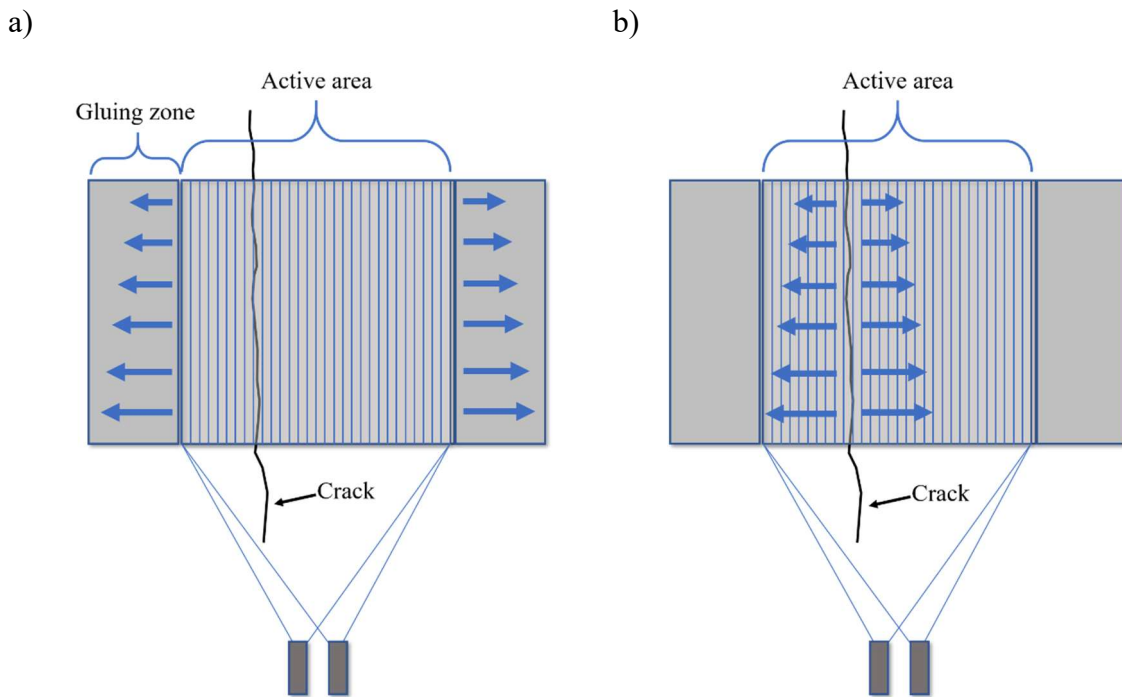

341 Fig 13. a) Sketch of on-surface patch crack behaviour; b) Sketch of embedded patch crack
342 behaviour

343

344 In patches glued on the surface of the sample (Fig 13-a), the active zone is not bonded to
345 the concrete. Consequently, any displacement between the two bonded zones results in a
346 uniform displacement among the fibres. Conversely, in patches embedded within the concrete
347 (Fig 13-b), the active zone adheres to the structure. Consequently, when a crack occurs, it
348 induces localized deformation of the patch, resulting in localized displacement among a small
349 number of fibres within the fracture zone.

350 **Performance assessment method**

351 A crack in a material is a discontinuity caused by the failure of atomic bonds to withstand
352 forces [33]. In concrete, crack opening is a complex mechanical process influenced by material
353 characteristics, loading conditions, and environmental factors. Cracks evolve from microcracks

354 into visible fissures. Initially, crack width is often microscopic and invisible to the naked eye,
355 but it can expand as the load increases. The initial crack width varies based on factors such as
356 the applied load, concrete's tensile strength, reinforcing elements, grain size, notches and
357 defects, confinement arrangement, aspect ratio, and other geometric attributes [33,34].

358 The evaluation methodology encompasses several steps, including the fabrication of
359 prismatic concrete samples of varying dimensions, the implementation of a calibration
360 procedure, the attachment of the calibrated patch to the concrete sample, the mechanical testing
361 of the sample to induce cracks, and an assessment of crack measurement accuracy through the
362 use of Digital Image Correlation. This study utilised 40 samples measuring $10\text{ cm} \times 10\text{ cm} \times$
363 40 cm , 8 samples measuring $15\text{ cm} \times 15\text{ cm} \times 60\text{ cm}$ (Fig 14-a), and 3 beams measuring 15 cm
364 $\times 25\text{ cm} \times 330\text{ cm}$ (Fig 14-b). For the sake of simplicity, these sample sizes will be referred to
365 as sample types 1, 2, and 3 (corresponding to dimensions $10 \times 10 \times 40\text{ cm}^3$, $15 \times 15 \times 60\text{ cm}^3$,
366 and $15 \times 25 \times 330\text{ cm}^3$, respectively). A mixture of sand (0-6 mm), gravel (4-10 mm for sample
367 type 1 and gravel 10 – 20 mm for the other two types), along with Vicat-Performat 52,5 N
368 cement and water, was used. The concrete is designed to meet the specifications of C30/37 for
369 severe exposure classes according to NF EN 1992-1-1 [5] regulations. To induce cracks in the
370 region of interest, notches with a height of 2 cm were created in the sample for specimen types
371 1 and 2. This was achieved by placing a wooden triangular prism at the midpoint of the sample's
372 length before pouring the concrete.

373

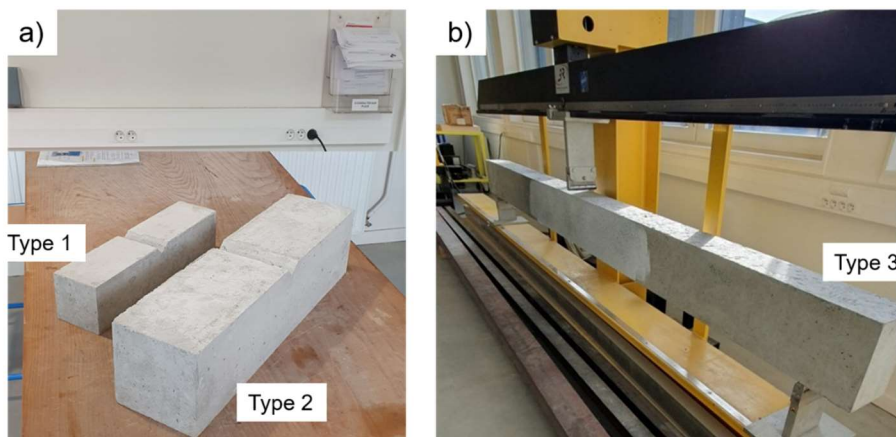

374

375 Fig 14. a) Sample sized $40 \times 10 \times 10\text{ cm}^3$ and $60 \times 15 \times 15\text{ cm}^3$; b) Beam of $330 \times 25 \times 15$
376 cm^3 placed at the 3-point bending test machine

377

378 In this investigation, both Type 1 and Type 2 samples exhibited identical aspect ratios and
379 notch sizes (Erreur ! Source du renvoi introuvable.). However, type 2 samples were

380 manufactured in two distinct configurations: with high-adhesion steel bars (reinforced) and
 381 without (non-reinforced). The reinforcement of type 2 specimens entailed the incorporation of
 382 two 8 mm diameter high-adhesion steel bars at the lower portion of the sample (Fig 15).
 383 Furthermore, three beams with no notches were reinforced (consisting of three 8 mm diameter
 384 high-adhesion steel bars at the lower section of the sample), with one of them additionally
 385 reinforced at the bottom surface with a layer of carbon-fibre-reinforced polymer (CFRP).
 386 CFRP, renowned for its exceptional properties, including lightweight, high strength, and
 387 resistance to high temperatures, holds significant promise for diverse applications across
 388 various fields, like structural repairs [35].

389

390 **Table 2.** Characteristics of specimens used in this study.

	Dimensions	Quantity	Reinforcement
Type 1	$10 \times 10 \times 40 \text{ cm}^3$	40	No
Type 2	$15 \times 15 \times 60 \text{ cm}^3$	5	No
Type 2	$15 \times 15 \times 60 \text{ cm}^3$	3	Bottom longitudinal reinforcement: $2 \times \varnothing 8 \text{ mm CA} - 50$
Type 3	$15 \times 25 \times 330 \text{ cm}^3$	2	Bottom longitudinal reinforcement: $3 \times \varnothing 8 \text{ mm CA} - 50$
Type 3	$15 \times 25 \times 330 \text{ cm}^3$	1	Bottom longitudinal reinforcement: $3 \times \varnothing 8 \text{ mm CA} - 50 +$ CFRP layer reinforcement

391

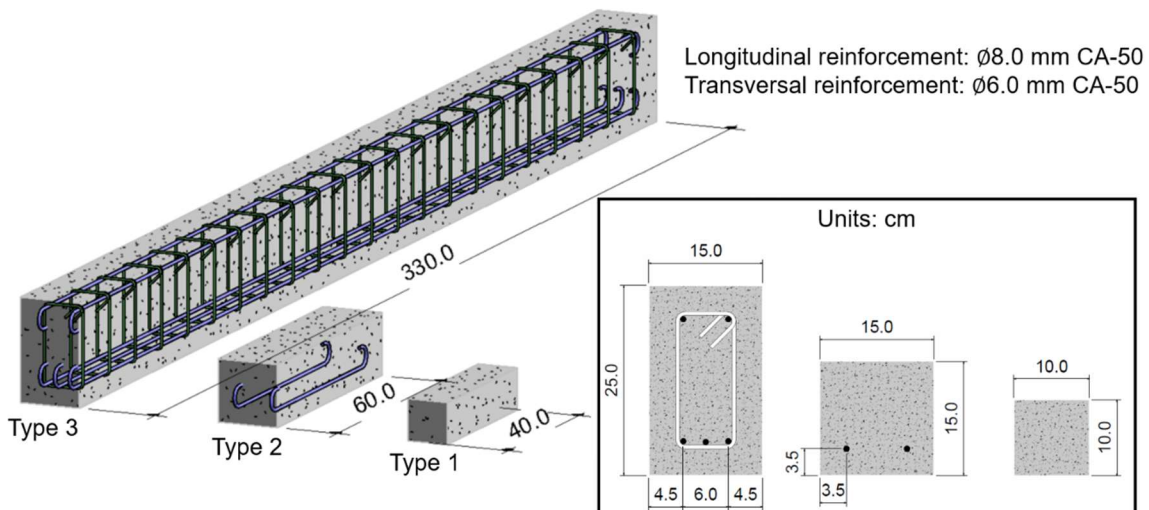

Fig 15. Sketch of the specimens used in this study.

392
393
394

395 Following calibration, the patches were attached to the surfaces of the specimens and
 396 subjected to a three-point bending test, a methodology similar to that employed by Gkantou M.
 397 et al. (2019) and Cimellaro G. P. et al. (2019) [36,37] in their investigation of crack detection
 398 in reinforced concrete structures. Specimens of types 1 and 2 were positioned symmetrically
 399 between two parallel supports and subjected to bending using a uniaxial displacement-
 400 controlled testing machine. The loading rate was 0.5 mm/min, and it was applied specifically
 401 to the central region of the sample adjacent to the upright section of the notch. In contrast,
 402 beams (type 3) underwent a stress-controlled three-point bending test at a rate of 0.05 kN/s.
 403 These modes dictate how the test is conducted and how data is gathered. In a displacement-
 404 controlled test, the testing machine applies a constant displacement rate to the specimen by
 405 moving the loading point at a predetermined speed. The resulting data is a function of the
 406 applied displacement and the force exerted. In a stress-controlled test, the testing machine
 407 is responsible for maintaining a specific force level or load on the specimen. One disadvantage of
 408 a displacement-controlled test is that the device controls the opening crack, which may not
 409 accurately reflect real-world conditions. In a force-controlled test, the behaviour of the
 410 specimen subsequent to the peak load is determined by the applied force, which is a more
 411 realistic representation of the conditions that would be encountered in a real-world scenario.

412 A 2D Digital Image Correlation (DIC) technique was applied to validate the performed
 413 calibration (Fig 16), utilising a NIKON D7000 camera with a 60 mm focal length. In
 414 mechanical testing, DIC can be applied through few different methods [38,39]. It is a non-
 415 destructive optical technique [40–42] that relies on a series of high-resolution images captured
 416 during deformation, at a specified frame rate. The process commences by applying a random

417 speckle pattern on the specimen's surface, which serves as unique identification marker. As the
418 material undergoes deformation, the camera captures images of the speckle pattern at various
419 stages. The spatial shifts of pixels between the initial and deformed states are tracked by
420 correlating their array of neighbouring pixels [43]. This technique allows for the computation
421 of full-field displacement and strain maps, revealing localized deformations and strain
422 distributions with high spatial resolution. DIC measurements can detect changes as small as a
423 single pixel or even sub-pixel, in the order of 0.01 to 0.1 pixels. In ideal conditions, the accuracy
424 of DIC displacement measurements can be in the range of 1 to 5 micrometres, or 0.01% of the
425 field of view. Nevertheless, the precise physical length represented by this measurement will
426 vary depending on factors such as the resolution of the camera and its distance from the surface
427 being measured. Following the guidelines provided in the DIC Good Practices Guide by the
428 International Digital Image Correlation Society (2017) [44], this study adopted a 2D-DIC
429 approach. It is assumed that the sample maintains planar characteristics and a consistent stand-
430 off distance throughout the testing process. To generate an appropriate speckle pattern for
431 analysis, a white background colour was uniformly applied to the region of interest (ROI).
432 Subsequently, black circular speckles were randomly superimposed on the white background
433 in order to guarantee adequate contrast.

434 It is essential to ensure that the frame rate employed aligns with the anticipated rate of
435 variation of the quantity of interest (QOI) in order to guarantee accurate results. If the
436 displacement between frames is excessive, the DIC algorithms may encounter difficulties in
437 locating the subset position within the resulting images [44]. In this study, a frame rate of 0.2
438 fps and a exposure time of 1/500 seconds were selected. The captured images have a resolution
439 of 300 dpi and a size of 4928×3264 pixels. The images were subsequently processed using
440 GOM Correlate 2018 software [45].

441 In this scenario, the Region Of Interest (ROI) corresponds to the surface area adjacent to
442 the crack, and the height of the ROI is the height of the textile sensor. This height limitation
443 dictates the extent to which the fiber optic textile can sense and respond to deformation. The
444 dispositive will sense the overall deformation, which is the incremental distance from the left
445 edge to the right edge of the textile. In bending tests, such as the three-point bending test, the
446 crack width varies; it is wider at the bottom and narrower at the top, forming a triangular shape
447 (Fig 16-a). The patch yields a single measurement representing the average crack width, as the
448 variation in crack width relative to height is nearly linear. Consequently, the patch provides the
449 crack width value for the mid-height.

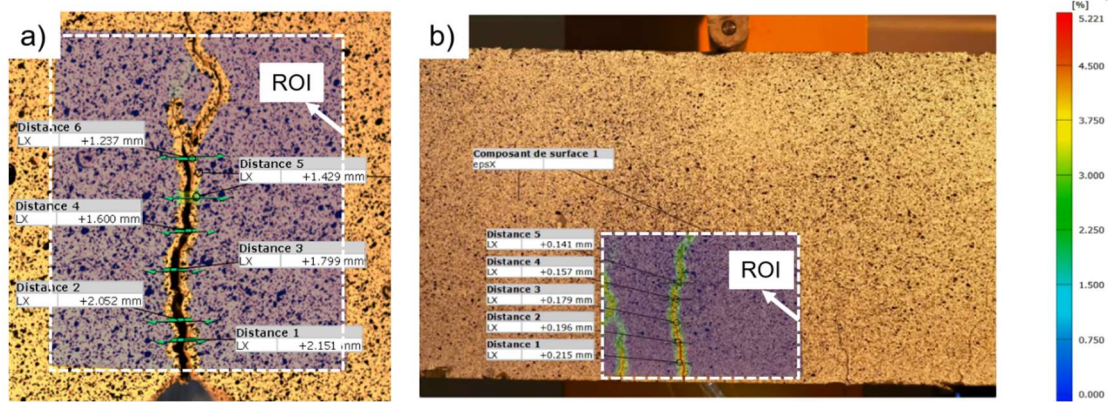

450

451 Fig 16. 2D Digital Image Correlation (DIC) performed at GOM Correlate 2018 Software: a)

452

sample size $10 \times 10 \times 40 \text{ cm}^3$; b) Reinforced beam.

453

454 Python modelling environment was utilised to transform the export files from the sensor

455 and from DIC analysis into a graphical comparison. This post processing includes reading both

456 csv files (from sensor and from DIC exports), fixing the initial absolute value of light signal as

457 zero, applying the equation of calibration on the values of increment in light signal in order to

458 obtain an output in millimetres, and plotting both lines in a single graphic.

459 Results

460 Crack detection

461 The diverse characteristics of the samples result in distinct patterns of crack initiation and

462 propagation. One notable distinction lies in the width of the crack upon its initial opening. This

463 disparity in crack width is not only attributed to differences in sample characteristics but also

464 to the inherent heterogeneity of concrete as a material. It is of great importance in order to

465 examine such variations in crack width at the onset of opening, particularly given the crucial

466 role of the sensor in detecting sudden crack openings or rapid crack developments, in addition

467 to gradual and smooth crack propagation.

468 It is observed that these sudden crack openings are observed predominantly present in

469 specimens lacking reinforcement, which constitute the majority of samples utilised in this study.

470 Fig 17- illustrates the results of a three-point bending test conducted on a Type 1 sample. The

471 image on the left depicts the final photograph taken prior to the emergence of the crack, while

472 the image on the right captures the subsequent moment. In contrast, Fig 17-a, depicts a type 3

473 sample, a steel-reinforced concrete beam (unreinforced by CFRP). In this instance, the crack

474 progresses from a microscopic to a macroscopic manifestation. The image on the left depicts

475 the moment preceding the appearance of the crack, while the image on the right illustrates the

476 subsequent moment. In both scenarios (Fig 17), the photos are captured at a 5-second interval,

477 consistent with the **selected** frame rate. Measurements conducted via digital image correlation
478 reveal that the type 3 sample in Fig 17-a exhibited an initial crack width of 3.5 μm , whereas the
479 type 1 sample in Fig 17-b displayed an initial crack width of 1.078 mm. As previously **stated**,
480 the heterogeneous nature of concrete results in varying crack opening values even among
481 specimens of the same type, as the results in the coming section will **demonstrate**.

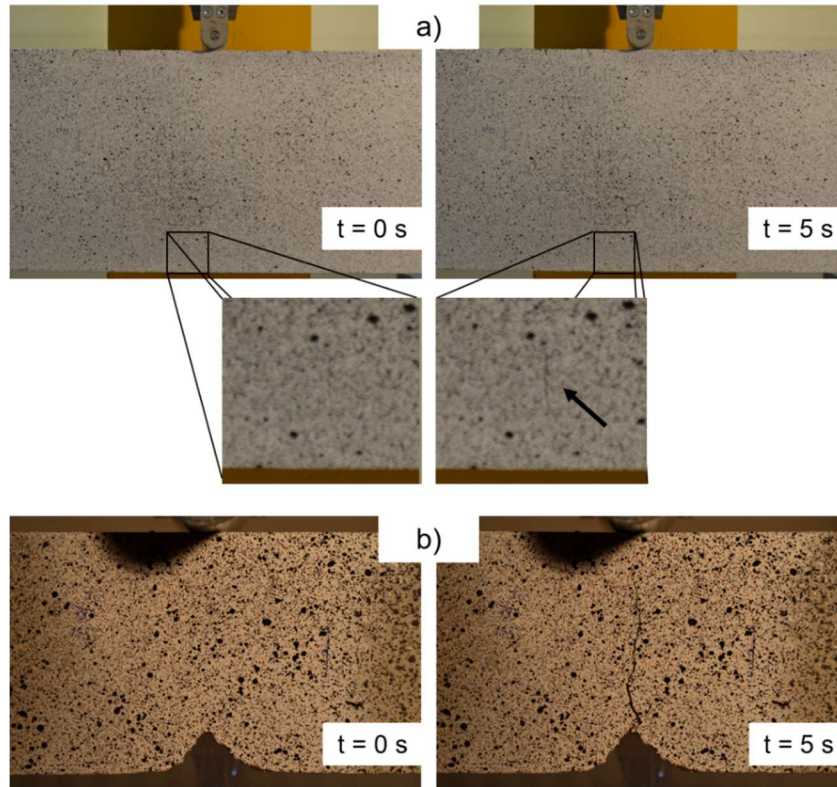

482
483 Fig 17. Crack opening onset a) Sample type 3; b) Sample type 1.
484

485 **In consideration of** the sensor's demonstrated sensitivity, when installed on the beam, the
486 patch **is capable of detecting** a gradual increase in crack width from the onset. With a sensitivity
487 of 0.004 mm/K for the patch affixed to the beam and a force rate of 0.05 kN/s, an average
488 increment of 1 unit of light spectral coordinates occurs approximately every 14 seconds (Fig
489 18-a). Conversely, for specimen type 1, the patch registers crack opening as an almost
490 instantaneous displacement of **approximately** 1 mm. In this instance, a sensitivity of 0.07 mm/K
491 is obtained for the patch in use, resulting in an increment of 15 units of CCT within 1.09
492 seconds, which represents the sensor's acquisition time (Fig 18-b).

a)

b)

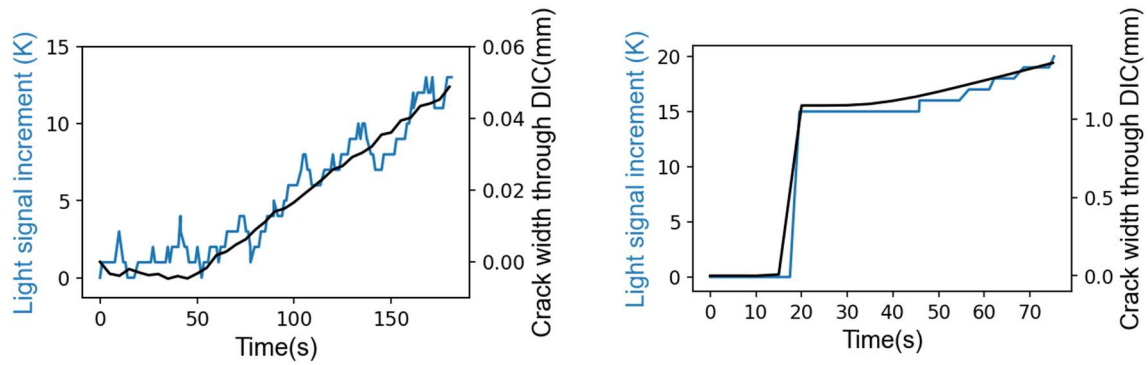

Fig 18. Crack detection a) Type 3; b) Type 1.

493

494

495 *Crack width evolution track*

496 The light signal measurements collected over time by the patch, along with the crack width
 497 measurements at mid-height of the patch position, obtained via Digital Image Correlation,
 498 underwent processing using Python, allowing for the application of correlation equations.
 499 Enhancements in patch configurations have significantly improved the sensor's **sensitivity**.
 500 Through refinement of these configurations, a sensor sensitivity of 0.004 mm/K **and an**
 501 **accuracy of 0.1% to 1%** has been achieved, as shown in Fig 19. **This figure presents 14 graphs,**
 502 **where each of them corresponds to the result one flexural test in a specimen, comparing the**
 503 **sensor measurement (blue line) of crack width to the Digital Image Correlation corresponding**
 504 **measurement of crack width (red line). Measurements were conducted on samples of different**
 505 **types and sizes, as indicated in each image.** Here, sensor sensitivity denotes the minimum
 506 increase in crack width (in mm) necessary to result in one unit change in CCT.

507 Upon examination of the **lines**, it **becomes** evident that the patch signal closely mirrors the
 508 onset and advancement of the crack. The **lines** exhibit a high degree of alignment. Initially, the
 509 crack width **line** experiences a rapid surge as the crack initiates in specimens of types 1 and 2,
 510 followed by a more gradual and consistent progression. Periodic abrupt increases occur
 511 **sometimes** (Fig 19-a) Fig 19. SENTMI sensor performance in following crack width due to
 512 material heterogeneity, such as aggregate rupture, introducing non-linearities.

513 The patch efficiently tracks both the gradual evolution and sudden spikes in crack width,
 514 demonstrating its capability to accurately capture these fluctuations and providing valuable
 515 insights into crack behaviour.

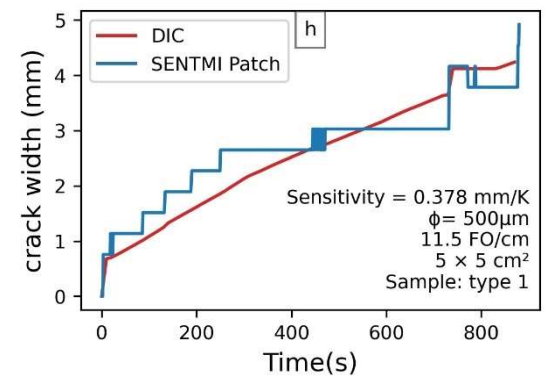
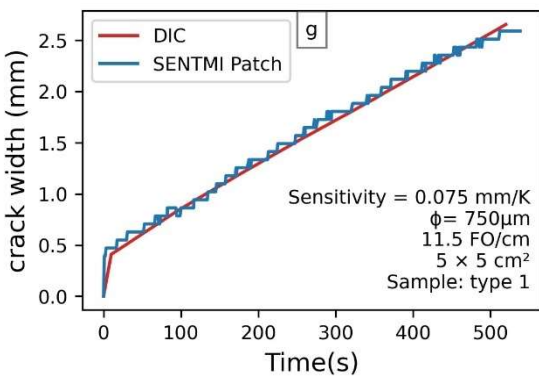
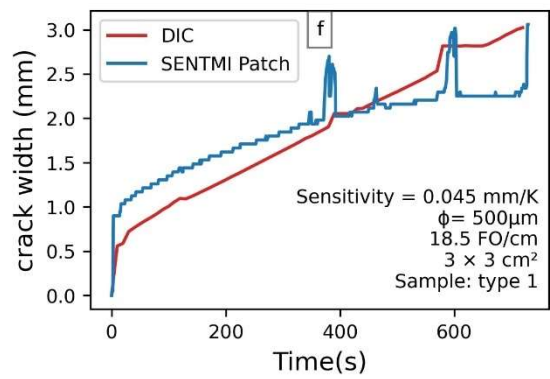
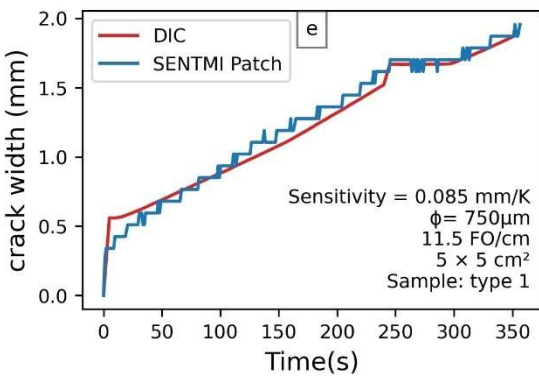
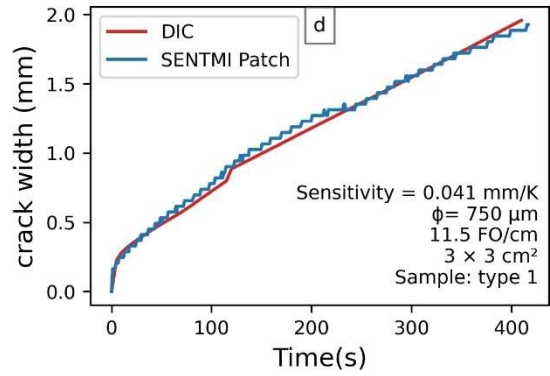
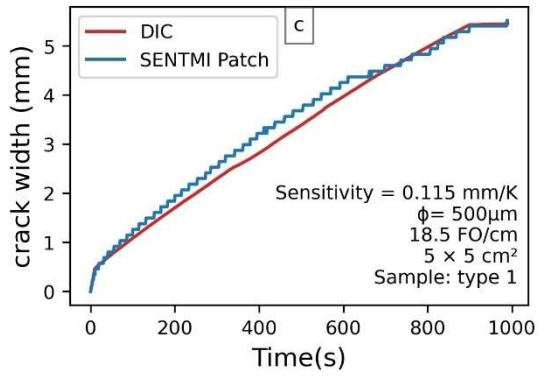
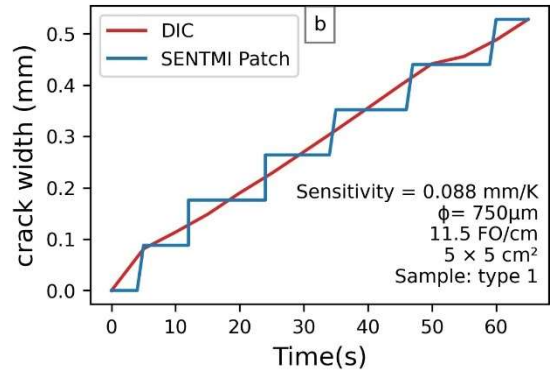
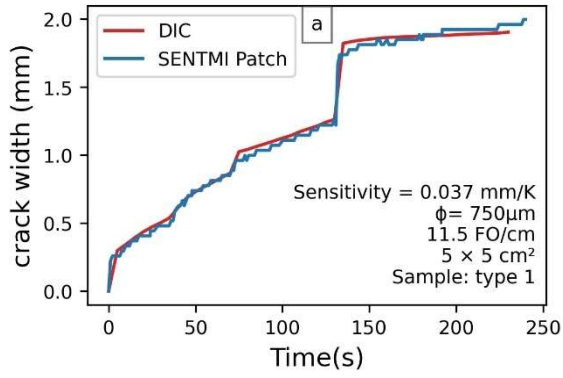

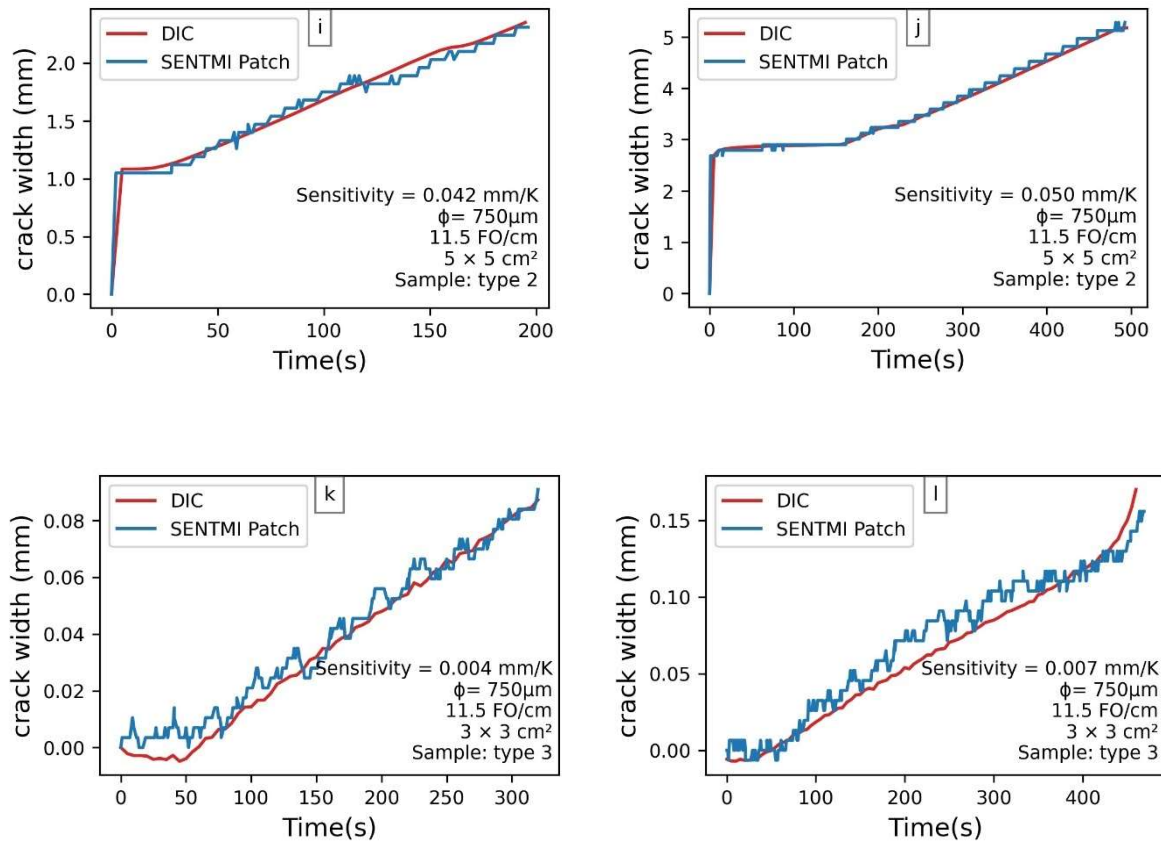

516 Fig 19. SENTMI sensor performance in following crack width

517 **Cyclic test**

518 It is crucial not only to monitor the evolution of crack openings, i.e., the increase in crack
 519 width, but also its converse, the decrease in crack width. The capacity of these sensors to
 520 measure displacements in both tension and compression modes is indispensable for a thorough
 521 understanding of structural integrity. In the field of civil engineering, where structures are
 522 subjected to a multitude of loads, including thermal gradients, wind, seismic forces, and traffic
 523 vibrations, deformation sensors ensure precise and reliable monitoring of structural responses.
 524 This bidirectional capability enables engineers to identify potential vulnerabilities, anticipate
 525 structural failures, and implement timely maintenance or corrective measures to
 526 comprehensively assess a material's mechanical properties.

527 Furthermore, measuring the variation of crack width in both directions assists engineers in
 528 monitoring the process of structural repair. Various methods exist to repair cracks in concrete,
 529 including the injection of fibres, epoxy resin, or the application of a carbon-fibre-reinforced
 530 layer [46].

531 For this test, a carbon-fiber-reinforced polymer (CFRP) layer was appropriately utilized to
 532 reinforce the bottom (tensile area) of the beam. Apart from its utility in repair applications, this
 533 beam has an advantage: due to the presence of the carbon layer, it could withstand higher loads

534 across numerous load and unload cycles, facilitating cyclic testing. The elastic properties of
535 CFRP enable the cracks to nearly close during unloading. The **high strength of this material**
536 **enables it to deform elastically under stress and revert to its original shape upon stress removal,**
537 **given the applied loads**[47].

538 **In order to** evaluate the beam reinforced with a layer of CFRP, a force-controlled three-
539 point bending test was conducted. Initially, a pre-charge of 3.2 KN was established. From this
540 point, the load progressively increased to 10 KN, then returned to 3.2 KN, repeating this cycle
541 three times. Subsequently, three additional cycles were performed, with the load reaching 18
542 KN before reverting to 3.2 KN. Finally, three **additional** cycles were **conducted**, elevating the
543 load to 26 KN before returning to 3.2 KN. The results are presented in Fig 20.

544 The sensor exhibited reliable performance, accurately tracking the crack's progression
545 during both opening and closing phases, although limited by the patch's sensitivity, set at 0.05
546 mm/K for this test. Therefore, when the force reached 18 KN, **for instance**, resulting in a crack
547 width of 0.19 mm, the sensor would display either 0.15 mm or 0.2 mm.
548

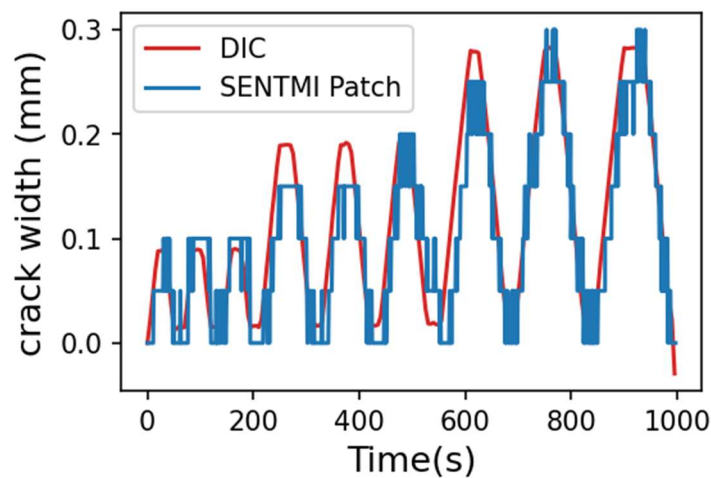

549
550
551

Fig 20. Sensor's performance in a cyclic test

552 ***Embedded patches***

553 **The capacity to function within the internal** structure of concrete is a critical attribute for a
554 displacement-measuring sensor. This **is** particularly significant in various construction
555 scenarios such as bridges or dams, where the installation of the sensor during concrete pouring
556 will be more practical, because re-accessing certain areas of the structures afterwards can be
557 challenging. Additionally, the internal behaviour of the structure may differ from its surface
558 behaviour, or cracks may arise first internally and propagate towards the exterior of the

559 structure. **Consequently**, internal fracture zones may be important for the professionals in
560 charge to keep track of [48,49].

561 The embedded SENTMI patches demonstrated consistent performance comparable to their
562 on-surface approach version, effectively monitoring the progression of cracks with a similar
563 **Mean Relative Error (MRE)** that the best on-surface patches presented, ranging between 0.1%
564 and 1%. Results are presented in Fig 21 on four samples tested under two different
565 configurations for density and diameter of optic fibres.

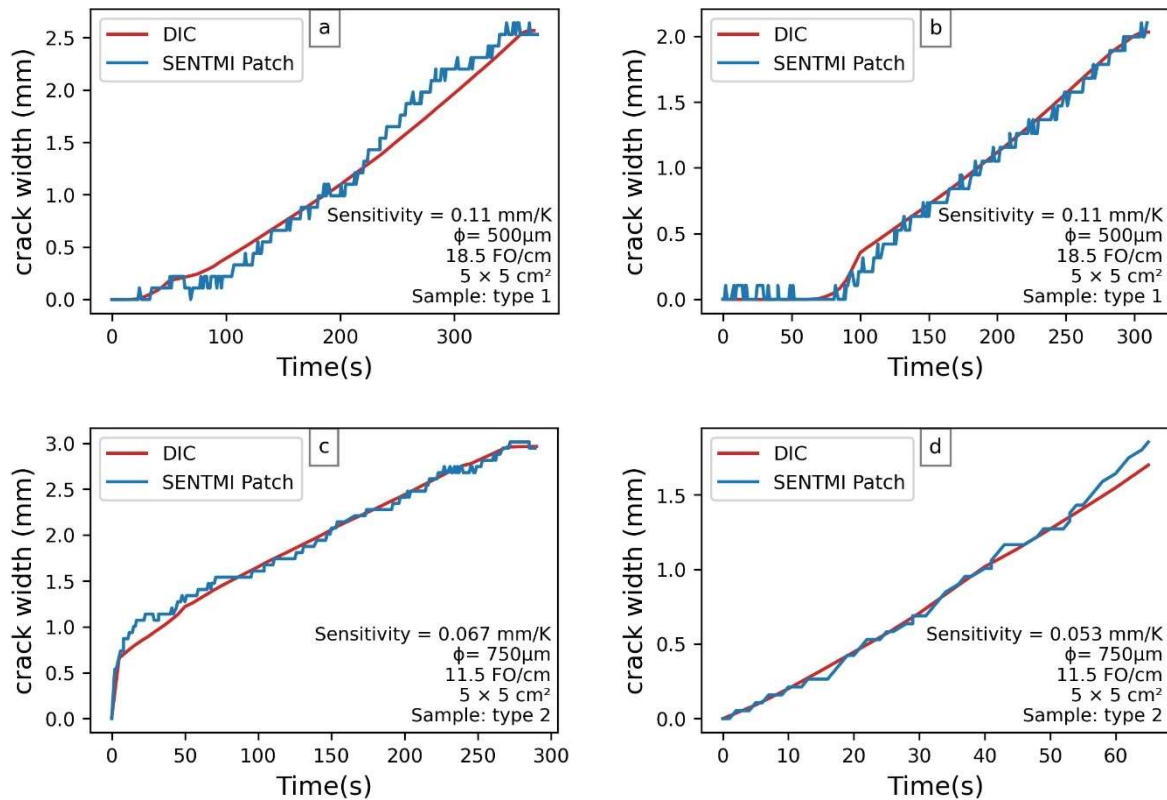

566 Fig 21. Results of crack width evolution for embedded patches

567

568 Conclusion

569 This work **presents** the initial key discoveries of a new fibre optic-based sensor developed
570 for **the purpose** of structural health monitoring. The sensor patch, which can be embedded or
571 **affixed** on a concrete structure surface, **comprises** a textile component containing two sets of
572 optical fibres: one set linked to a light source (emitting fibres) and the other to a light sensor
573 (receiving fibres). The deformation of the textile causes spectral coordinate variations,
574 measured in correlated colour temperature, providing crucial data for structural assessment.
575 Initially, the study concentrated on identifying configurations capable of **achieving a sensitivity**
576 **under the limits of recommended crack width limits, thus enabling the detection of minor**

577 displacement. Sensitivity is defined as the amount of displacement between the two edges of
578 the sensor required to result in the variation of the spectral coordinates by one unit. Therefore,
579 the most sensitive sensors present a lower amount of displacement needed for measurement
580 variation. The parameters under analysis included the diameter of the optical fibres, the density
581 of optical fibres per centimetre, and the dimensions of the fabric.

582 It was observed that larger diameters and higher densities of optical fibres were associated
583 with stronger light signals and enhanced sensor sensitivity. As a result, the optimal
584 configuration was determined to be optical fibres with a diameter of 750 μm and a density of
585 11.5 fibres per cm. This density represents the maximum number of fibres of this diameter that
586 can be accommodated within a width of 1 cm.

587 The installation methods for textile sensors on concrete surfaces were investigated. The
588 distinction between methods 1 and 2 lies in the proximity between the adhesive zone and the
589 sensitive region of the fabric. In method 1, the adhesive zone begins from the edge of the active
590 region, causing the active zone to absorb all the deformation resulting from the discontinuity
591 (crack) between the two adhesive zones. As a result, method 1 offers higher sensor sensitivity,
592 up to 0.004 mm/K. Conversely, in method 2, the adhesive is applied at a distance from the
593 active zone, reducing sensor sensitivity but expanding the measurement field, which is
594 described as the gap between the two adhesive zones. A similar patch was tested using both
595 methods and it attained a sensitivity of 0.05 mm/K in method 1, while for method 2 it attained
596 a sensitivity of 0.09 mm/K. In method 2, the glue was applied 2.5 cm from the edge of the active
597 zone, which is $5 \times 5 \text{ cm}^2$. Patches were also embedded into the concrete specimens, using a
598 prismatic piece of wood to create the notch and fix the position of the textile sensor.

599 Once the optimal sensor configuration and its installation system has been identified,
600 calibration was carried out. A series of stretching and releasing cycles was conducted in order
601 to compute the equation of correlation via polynomial regression. The calibration was followed
602 by the application of the textiles to concrete specimens of varying dimensions. These samples
603 underwent a three-point bending test to induce cracking, after which the performance of the
604 sensors was evaluated using digital image correlation. The mean relative error for the embedded
605 and glued patches across all sample types was found to be between 0.1% and 1%.

606 The diverse geometry and reinforcement of the specimens enabled the sensor to
607 demonstrate its capacity to detect both gradual and abrupt crack initiations. The progression of
608 the cracks, including both opening and closing phases, was analysed. The preliminary results
609 are promising, with a sensitivity of up to 0.004 mm/K and a mean relative error for the
610 embedded and glued patches across all sample types was found to be between 0.1% and 1%.

611 In the context of large structures, cracks may emerge as a consequence of mechanical and
612 thermal stresses. It would be beneficial to investigate the impact of temperature on the optical
613 patch sensor in both damaged and undamaged structures in the subsequent phase of this study.

614 **Data availability**

615 Some or all data of this study are available from the corresponding author upon reasonable
616 request.

617 **Acknowledgement**

618 The realization of this project, known as SENTMI, has been made possible through
619 financial support from La Région AURA (PSPC 2020) and BPI France. The success of this
620 study owes much to the dedication and collaborative efforts of various entities, including Leon
621 Grosse, Inouid, Brochier Technologies, and the LOCIE laboratory at the University of Savoie
622 Mont Blanc. The authors extend their gratitude to Pellier Francois and Marie Allain from Léon
623 Grosse company, Brochier Cedric and Richaud Martin from Brochier Technologies company,
624 and Briand Didier from Inouid firm for their valuable insights and discussions.

625 **References**

- 626 [1] S. Taheri, A review on five key sensors for monitoring of concrete structures, *Constr*
627 *Build Mater* 204 (2019) 492–509. <https://doi.org/10.1016/j.conbuildmat.2019.01.172>.
- 628 [2] W.H. Duan, Q. Wang, S.T. Quek, Applications of piezoelectric materials in structural
629 health monitoring and repair: Selected research examples, *Materials* 3 (2010) 5169–
630 5194. <https://doi.org/10.3390/ma3125169>.
- 631 [3] B. Mather, Concrete durability, *Cem Concr Compos* 26 (2004) 3–4.
632 [https://doi.org/10.1016/S0958-9465\(02\)00122-1](https://doi.org/10.1016/S0958-9465(02)00122-1).
- 633 [4] H. Al-Karawi, R.U.F. von Bock und Polach, M. Al-Emrani, Crack detection via strain
634 measurements in fatigue testing, *Strain* 57 (2021). <https://doi.org/10.1111/str.12384>.
- 635 [5] CEN (European Committee for Standardization), EN 1992-1-1 (2004): Eurocode 2:
636 Design of concrete structures - Part 1-1: General rules and rules for buildings, Brussels,
637 Belgium: CEN., (2004).
- 638 [6] CEN (European Committee for Standardization), EN 1992-3 (2006): Eurocode 2: Design
639 of concrete structures - Part 3: Liquid retaining and containment structures, 2006.
- 640 [7] S. Villalba, J.R. Casas, Application of optical fiber distributed sensing to health
641 monitoring of concrete structures, *Mech Syst Signal Process* 39 (2013) 441–451.
642 <https://doi.org/10.1016/j.ymsp.2012.01.027>.

- 643 [8] A. Barrias, G. Rodriguez, J.R. Casas, S. Villalba, Application of distributed optical fiber
644 sensors for the health monitoring of two real structures in Barcelona, *Structure and*
645 *Infrastructure Engineering* 14 (2018) 967–985.
646 <https://doi.org/10.1080/15732479.2018.1438479>.
- 647 [9] M. Allain, O. Ple, N. Prime, E. Roux, P. Vacher, In situ DIC method to determine stress
648 state in reinforced concrete structures, *Measurement (Lond)* 210 (2023).
649 <https://doi.org/10.1016/j.measurement.2023.112483>.
- 650 [10] J. Chakraborty, A. Katunin, P. Klikowicz, M. Salamak, Early crack detection of
651 reinforced concrete structure using embedded sensors, *Sensors (Switzerland)* 19 (2019).
652 <https://doi.org/10.3390/s19183879>.
- 653 [11] P. Prasanna, K.J. Dana, N. Gucunski, B.B. Basily, H.M. La, R.S. Lim, H. Parvardeh,
654 Automated Crack Detection on Concrete Bridges, *IEEE Transactions on Automation*
655 *Science and Engineering* 13 (2016) 591–599.
656 <https://doi.org/10.1109/TASE.2014.2354314>.
- 657 [12] T. Yamaguchi, S. Nakamura, R. Saegusa, S. Hashimoto, Image-based crack detection
658 for real concrete surfaces, *IEEJ Transactions on Electrical and Electronic Engineering* 3
659 (2008) 128–135. <https://doi.org/10.1002/tee.20244>.
- 660 [13] G. Rodriguez, J.R. Casas, S. Villalba, Shear crack pattern identification in concrete
661 elements via distributed optical fibre grid., *Structure and Infrastructure Engineering* 15
662 (2019) 1630–1648.
- 663 [14] I. Fernandez, C.G. Berrocal, R. Rempling, Two-dimensional strain field analysis of
664 reinforced concrete D-regions based on distributed optical fibre sensors, *Eng Struct* 278
665 (2023). <https://doi.org/10.1016/j.engstruct.2022.115562>.
- 666 [15] M.F. Bado, J.R. Casas, A review of recent distributed optical fiber sensors applications
667 for civil engineering structural health monitoring, *Sensors* 21 (2021) 1–83.
668 <https://doi.org/10.3390/s21051818>.
- 669 [16] K. Zdanowicz, D. Gebauer, M. Koschemann, K. Speck, O. Steinbock, B. Beckmann, S.
670 Marx, Distributed fiber optic sensors for measuring strains of concrete, steel, and textile
671 reinforcement: Possible fields of application, *Structural Concrete* 23 (2022) 3367–3382.
672 <https://doi.org/10.1002/suco.202100689>.
- 673 [17] T. Janiak, H. Becks, B. Camps, M. Classen, J. Hegger, Evaluation of distributed fibre
674 optic sensors in structural concrete, *Materials and Structures/Materiaux et Constructions*
675 56 (2023). <https://doi.org/10.1617/s11527-023-02222-9>.

- 676 [18] C. Zhu, H. Zheng, L. Ma, Z. Yao, B. Liu, J. Huang, Y. Rao, Advances in Fiber-Optic
677 Extrinsic Fabry-Perot Interferometric Physical and Mechanical Sensors: A Review,
678 IEEE Sens J 23 (2023) 6406–6426. <https://doi.org/10.1109/JSEN.2023.3244820>.
- 679 [19] F.I.H. Sakiyama, F. Lehmann, H. Garrecht, Structural health monitoring of concrete
680 structures using fibre-optic-based sensors: A review, Magazine of Concrete Research 73
681 (2021) 174–194. <https://doi.org/10.1680/jmacr.19.00185>.
- 682 [20] P.K.S. Manish Mishra, Fiber Bragg Gratings in Healthcare Applications: A Review.
683 IETE Technical Review, IETE Technical Review 40 (2023).
- 684 [21] J.K. Sahota, N. Gupta, D. Dhawan, Fiber Bragg grating sensors for monitoring of
685 physical parameters: a comprehensive review, Optical Engineering 59 (2020) 1.
686 <https://doi.org/10.1117/1.oe.59.6.060901>.
- 687 [22] H.Y. Qin, Q.X. Shen, W.X. Zhu, H.L. Zhang, Range-expansion technology and fatigue
688 performance study on the self-sensing steel strand with an embedded fibre Bragg grating
689 sensor, Strain 56 (2020). <https://doi.org/10.1111/str.12354>.
- 690 [23] C.Y. Wei, S.W. James, C.C. Ye, R.P. Tatam, P.E. Irving, Application issues using fibre
691 Bragg gratings as strain sensors in fibre composites, Strain 36 (2000) 143–150.
692 <https://doi.org/10.1111/j.1475-1305.2000.tb01190.x>.
- 693 [24] B. Torres Górriz, P. Rinaudo, P.A. Calderón García, Comparison between point and
694 long-gage FBG-based strain sensors during a railway bridge load test, Strain 53 (2017).
695 <https://doi.org/10.1111/str.12230>.
- 696 [25] J. Waldbjørn, J. Høgh, J. Wittrup-Schmidt, M.W. Nielsen, K. Branner, H. Stang, C.
697 Berggreen, Strain and displacement controls by fibre bragg grating and digital image
698 correlation, Strain 50 (2014) 262–273. <https://doi.org/10.1111/str.12089>.
- 699 [26] S. Liu, F. Yu, R. Hong, W. Xu, L. Shao, F. Wang, Advances in phase-sensitive optical
700 time-domain reflectometry, Opto-Electronic Advances 5 (2022).
701 <https://doi.org/10.29026/oea.2022.200078>.
- 702 [27] S.Z. et al. Qinlin Cai, Optical frequency domain reflectometry sensing for damage
703 detection in long-span bridges using influence surface, Struct Health Monit 22 (2023).
- 704 [28] P. Lu, N. Lalam, M. Badar, B. Liu, B.T. Chorpening, M.P. Buric, P.R. Ohodnicki,
705 Distributed optical fiber sensing: Review and perspective, Appl Phys Rev 6 (2019).
706 <https://doi.org/10.1063/1.5113955>.
- 707 [29] M. Elsherif, A.E. Salih, M.G. Muñoz, F. Alam, B. AlQattan, D.S. Antonysamy, M.F.
708 Zaki, A.K. Yetisen, S. Park, T.D. Wilkinson, H. Butt, Optical Fiber Sensors: Working

- 709 Principle, Applications, and Limitations, *Adv Photonics Res* 3 (2022).
710 <https://doi.org/10.1002/adpr.202100371>.
- 711 [30] C., C.D., D.E., M.J., M.C., P.-C.J. Brochier, Système de détection apte à générer un
712 signal électrique représentatif d'une variation d'intensité lumineuse et capteur de
713 pression intégrant un tel système de détection, 2017.
- 714 [31] ams OSRAM, AS7261 XYZ Chromatic White Color Sensor + NIR with Electronic
715 Shutter and Smart Interface, (2016).
- 716 [32] M. Richaud, C. Brochier, M. Allain, F. Pellier, D. Briand, N. Briand, O. Plé, Y. De Souza
717 Gomes, M. Saidi, A. Lushnikova, Détecteur de déformation à base de fibres optiques, et
718 procédé de calibration d'un tel détecteur, B256-B-69739, 2024.
- 719 [33] G.L. Golewski, The Phenomenon of Cracking in Cement Concretes and Reinforced
720 Concrete Structures: The Mechanism of Cracks Formation, Causes of Their Initiation,
721 Types and Places of Occurrence, and Methods of Detection—A Review, *Buildings* 13
722 (2023). <https://doi.org/10.3390/buildings13030765>.
- 723 [34] G. Tiberti, F. Minelli, G.A. Plizzari, F.J. Vecchio, Influence of concrete strength on crack
724 development in SFRC members, *Cem Concr Compos* 45 (2014) 176–185.
725 <https://doi.org/10.1016/j.cemconcomp.2013.10.004>.
- 726 [35] H. Zheng, W. Zhang, B. Li, J. Zhu, C. Wang, G. Song, G. Wu, X. Yang, Y. Huang, L.
727 Ma, Recent advances of interphases in carbon fiber-reinforced polymer composites: A
728 review, *Compos B Eng* 233 (2022). <https://doi.org/10.1016/j.compositesb.2022.109639>.
- 729 [36] G. Paolo Cimellaro, M. Domaneschi, A. Cardoni, D. Inaudi, I. Cottone, F. Ansari, Crack
730 Detection Using Embedded Fiber-Optic Sensors in Reinforced Concrete Beams, n.d.
- 731 [37] M. Gkantou, M. Muradov, G.S. Kamaris, K. Hashim, W. Atherton, P. Kot, Novel
732 electromagnetic sensors embedded in reinforced concrete beams for crack detection,
733 *Sensors (Switzerland)* 19 (2019). <https://doi.org/10.3390/s19235175>.
- 734 [38] S. Hedan, V. Valle, P. Cosenza, Subpixel precision of crack lip movements by
735 Heaviside-based digital image correlation for a mixed-mode fracture, *Strain* 56 (2020).
736 <https://doi.org/10.1111/str.12346>.
- 737 [39] A. Blug, F. Conrad, A. Bertz, C. Kontermann, D. Carl, M. Oechsner, Application of
738 high-performance DIC for a comprehensive evaluation of biaxial fatigue crack growth
739 experiments, *Strain* 59 (2023). <https://doi.org/10.1111/str.12455>.
- 740 [40] M. Saidi, A. Gabor, Adaptation of the strain measurement in textile reinforced
741 cementitious matrix composites by distributed optical fibre and 2D digital image
742 correlation, *Strain* 56 (2020). <https://doi.org/10.1111/str.12335>.

- 743 [41] A. Armonico, M. Saidi, L. Michel, S. Bel, E. Ferrier, Inverse analysis based on DFOS
744 technology for the study of the bonding behaviour of FRP to concrete beams, *Mater*
745 *Today Commun* 35 (2023). <https://doi.org/10.1016/j.mtcomm.2023.105655>.
- 746 [42] T.H. Becker, Extracting fracture properties from digital image and volume correlation
747 displacement data: A review, *Strain* (2023). <https://doi.org/10.1111/str.12469>.
- 748 [43] N. Gehri, J. Mata-Falcón, W. Kaufmann, Automated crack detection and measurement
749 based on digital image correlation, *Constr Build Mater* 256 (2020).
750 <https://doi.org/10.1016/j.conbuildmat.2020.119383>.
- 751 [44] J.E.M.C. and I.M.A. (Eds.) International Digital Image Correlation Society, *A Good*
752 *Practices Guide for Digital Image Correlation*, (2018).
- 753 [45] Gom correlate, 3D displacements and strains in motion pictures, (2018).
754 <https://www.gom.com/en/products/metrology-software/gom-correlate-pro> (accessed
755 January 15, 2024).
- 756 [46] M.A. Abed, J. Fořt, A. Naoulo, A. Essa, Influence of polypropylene and steel fibers on
757 the performance and crack repair of self-compacting concrete, *Materials* 14 (2021).
758 <https://doi.org/10.3390/ma14195506>.
- 759 [47] C. Chen, Y. Yang, Y. Zhou, C. Xue, X. Chen, H. Wu, L. Sui, X. Li, Comparative analysis
760 of natural fiber reinforced polymer and carbon fiber reinforced polymer in strengthening
761 of reinforced concrete beams, *J Clean Prod* 263 (2020).
762 <https://doi.org/10.1016/j.jclepro.2020.121572>.
- 763 [48] J. Luo, Y. Wang, S. Asamoto, K. Nagai, Mesoscopic simulation of crack propagation
764 and bond behavior in ASR damaged concrete with internal/external restraint by 3D
765 RBSM, *Cem Concr Compos* 129 (2022).
766 <https://doi.org/10.1016/j.cemconcomp.2022.104488>.
- 767 [49] P.M. Ferreira, M.A. Machado, M.S. Carvalho, C. Vidal, Embedded Sensors for
768 Structural Health Monitoring: Methodologies and Applications Review, *Sensors* 22
769 (2022). <https://doi.org/10.3390/s22218320>.

770