

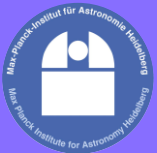

Open loop calibration and closed loop non perturbative estimation of the lateral errors of an adaptive optics system



Examples with GRAVITY+ and CHARA experimental data



Anthony Berdeu, Henri Bonnet, Jean-Baptiste Le Bouquin, Guillaume Bourdarot, Johann Kolb, Philippe Berio, Thibaut Paumard, Frank Eisenhauer, Christian Straubmeier, Paulo Garcia, Sebastian Hömig, Florentin Millour, Denis Defrère, Ferréol Soulez, Denis Mourard, Gail Schaefer, Narsireddy Anugu and **GRAVITY+ COLLABORATION**



Contact:
anthony.berdeu@obspm.fr



Open loop preset: modal perturbation

1. Open loop / shifted pupil
2. Measuring a partial modal IM
3. Shift estimation via a lateral fit with a reference (synthetic or measured)

Reference KL-mode
(slopes)

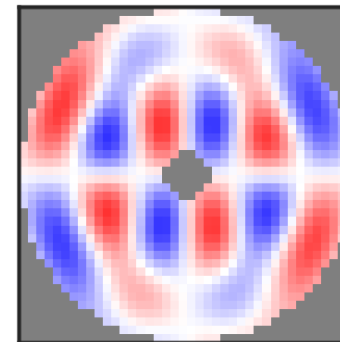

Shifted measure

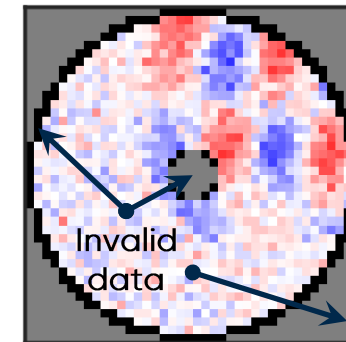

2D correlation?

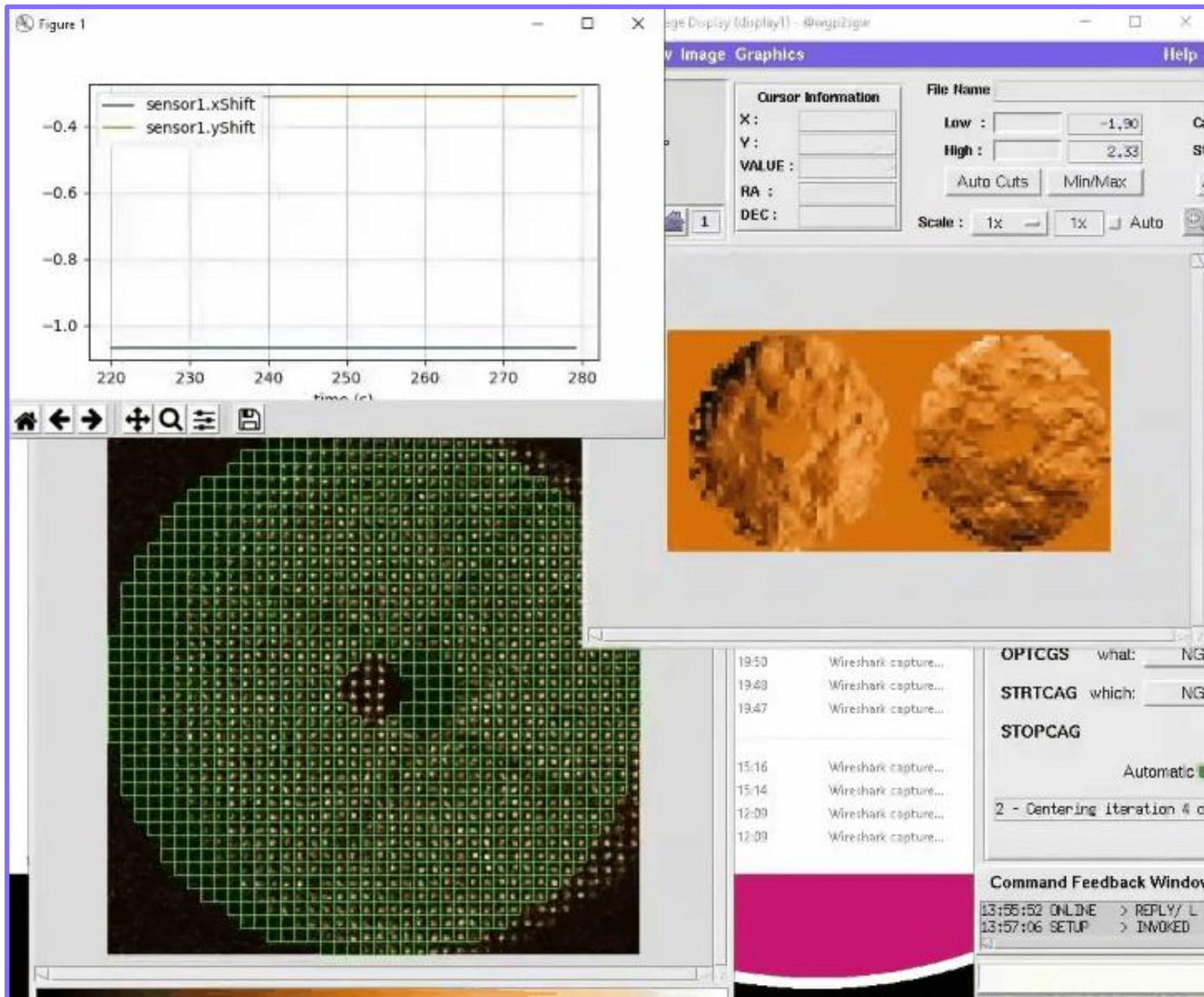
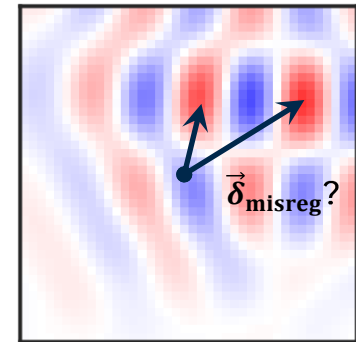

Open loop preset: modal perturbation

1. Open loop / shifted pupil
2. Measuring a partial modal IM
3. Shift estimation via a lateral fit with a reference (synthetic or measured)

Reference KL-mode
(slopes)

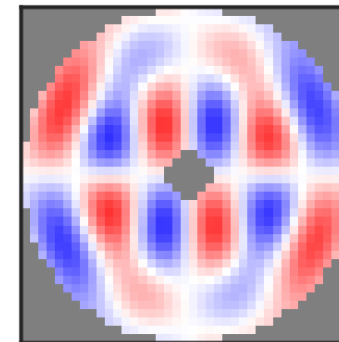

Shifted measure

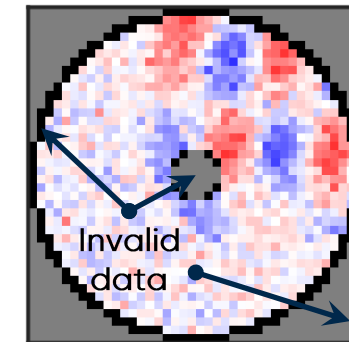

Inverse problem

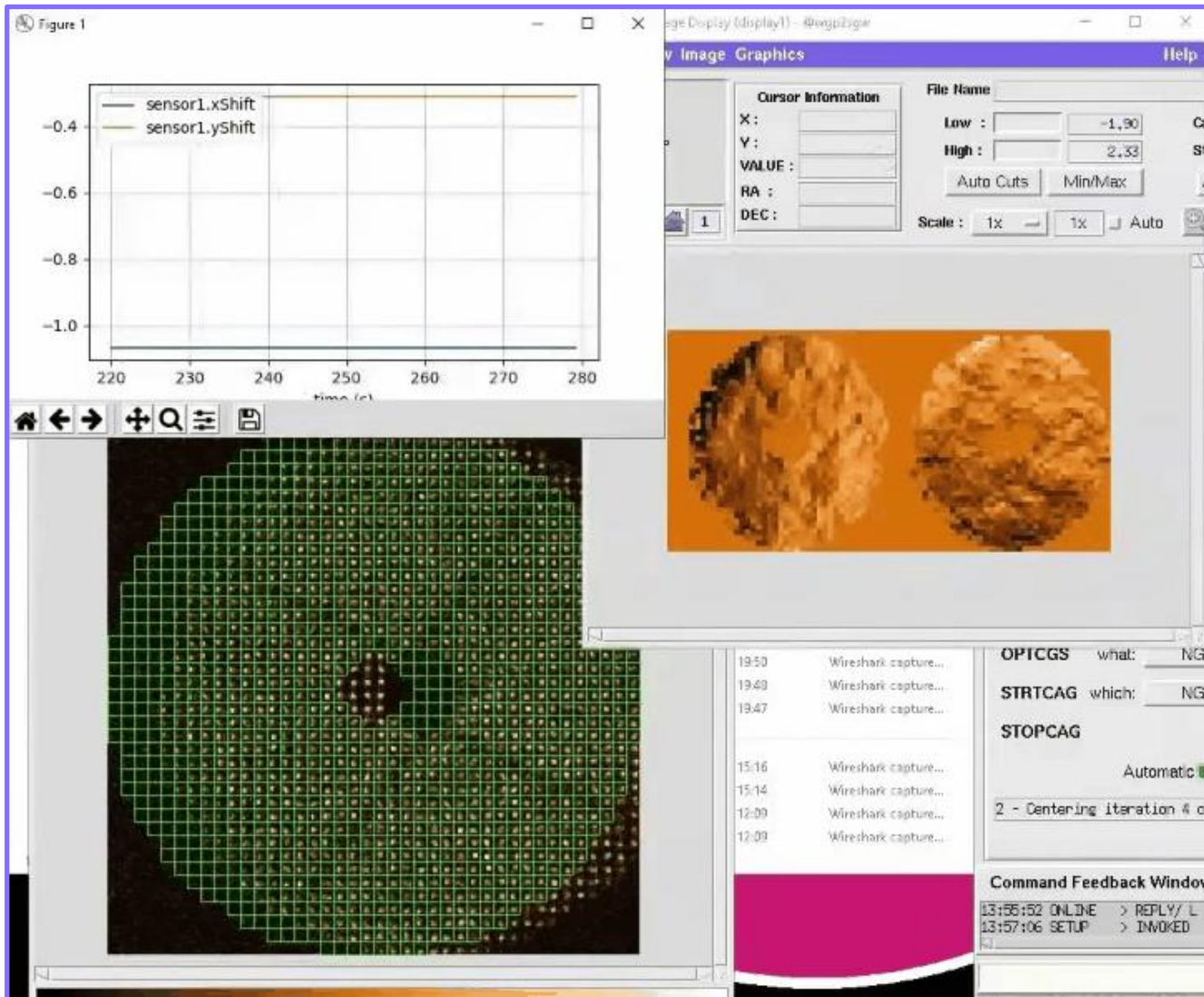
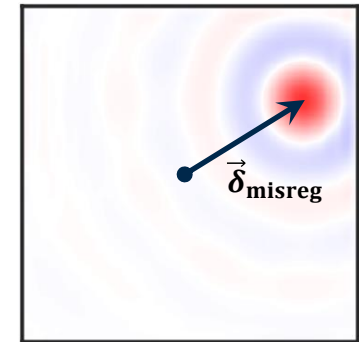

Open loop preset: modal perturbation

1. Open loop / shifted pupil
2. Measuring a partial modal IM
3. Shift estimation via a lateral fit with a reference (synthetic or measured)

Reference KL-mode
(slopes)

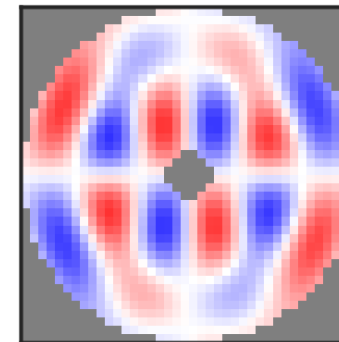

Shifted measure

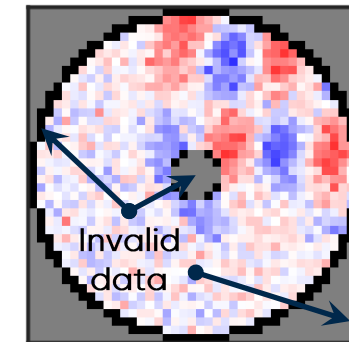

Inverse problem

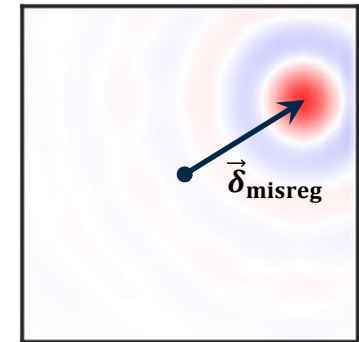

- Take home messages:
 - Fast and robust **open loop mis-registration estimator**
 - Super-resolved centering with **large capture range**
 - No slow PSIM fitting needed
- More in the **proceeding + A&A paper**

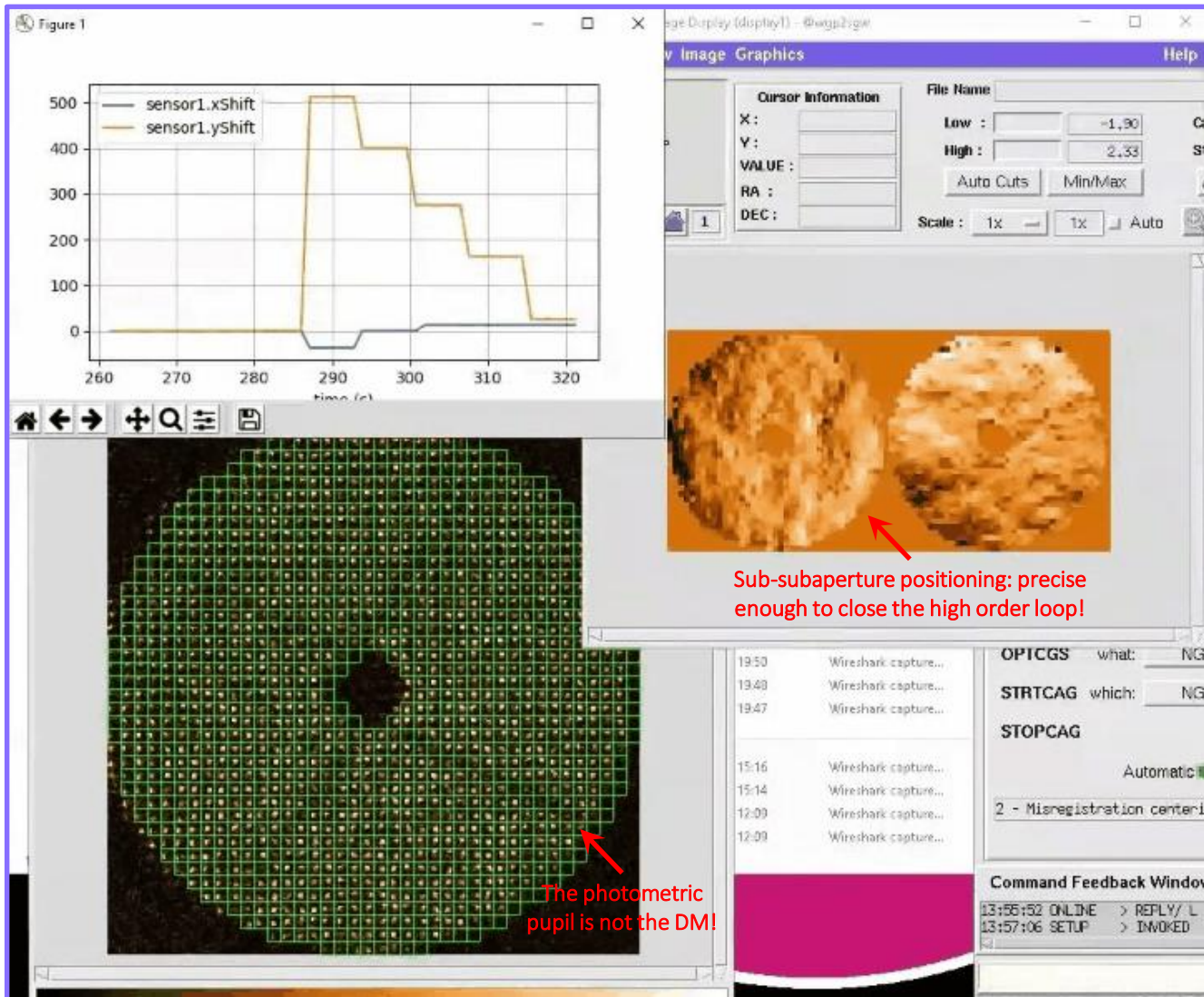

Closed loop – Lesson 101

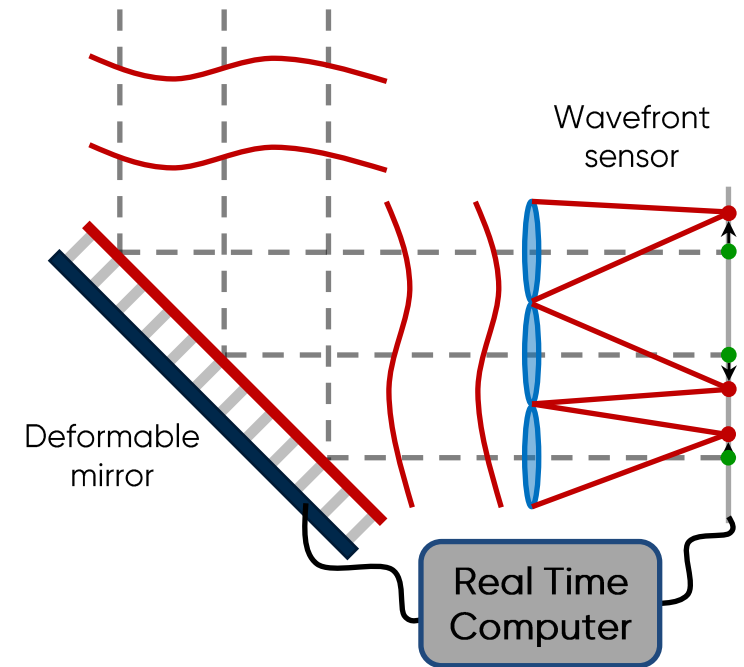
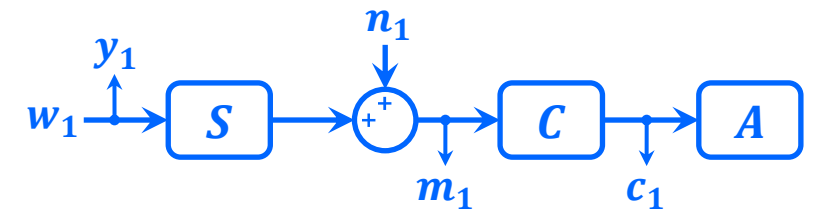
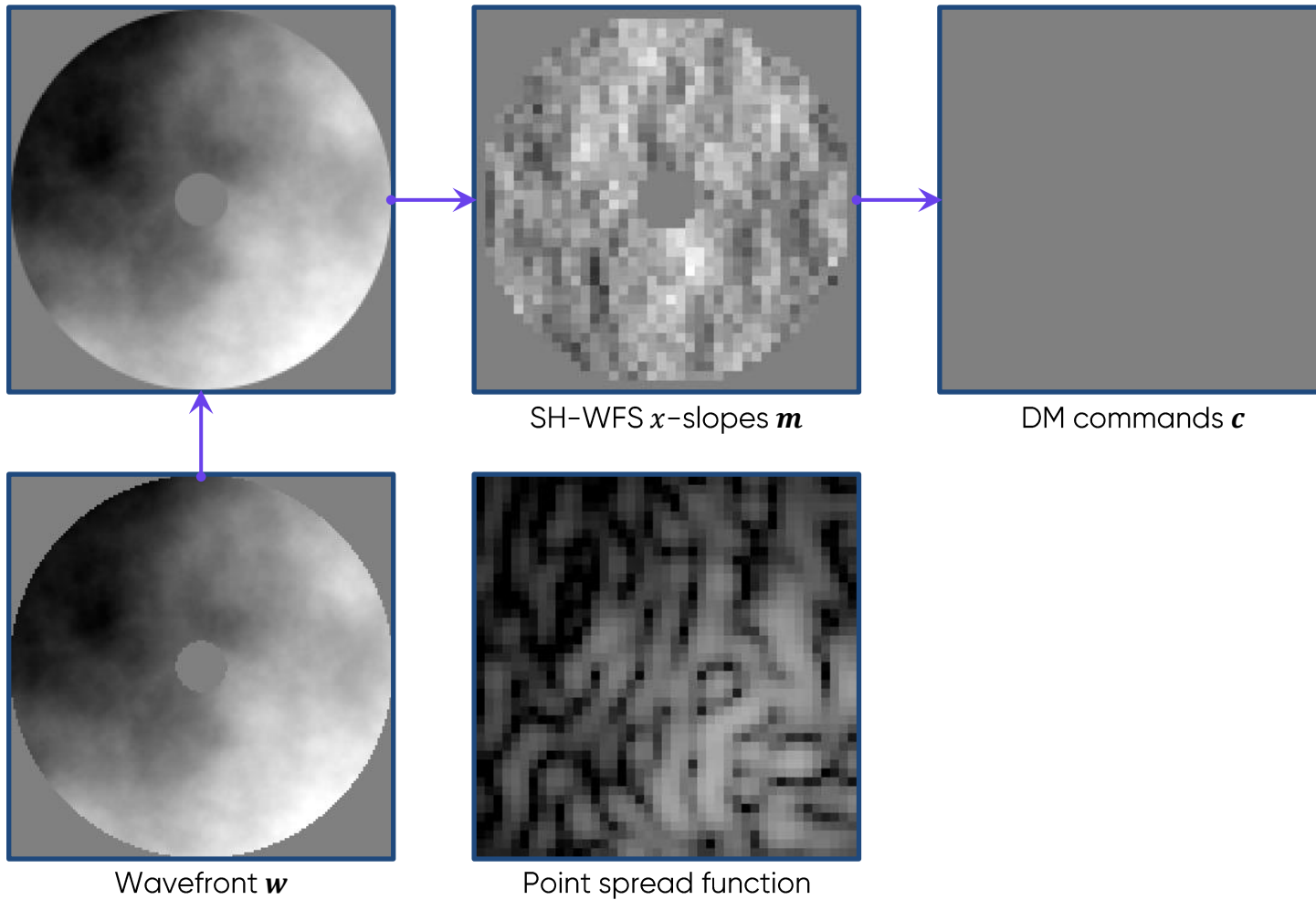

Closed loop – Lesson 101

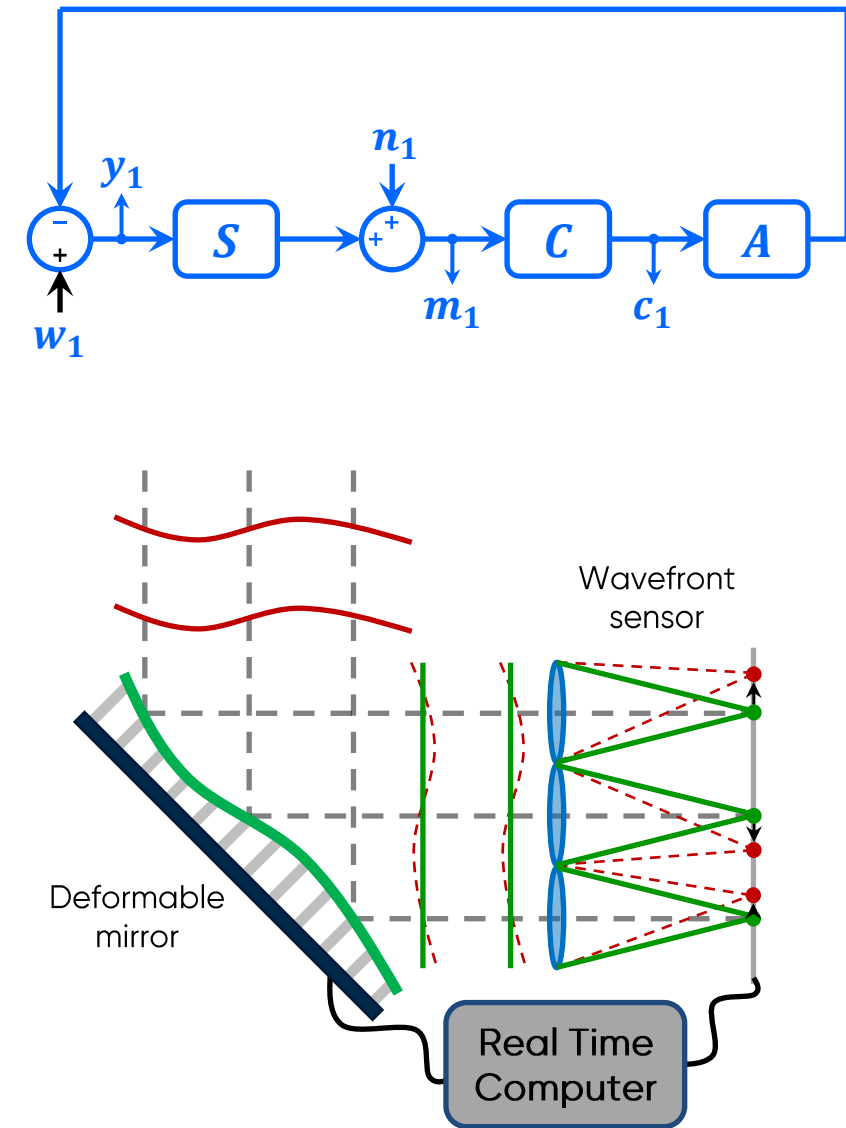
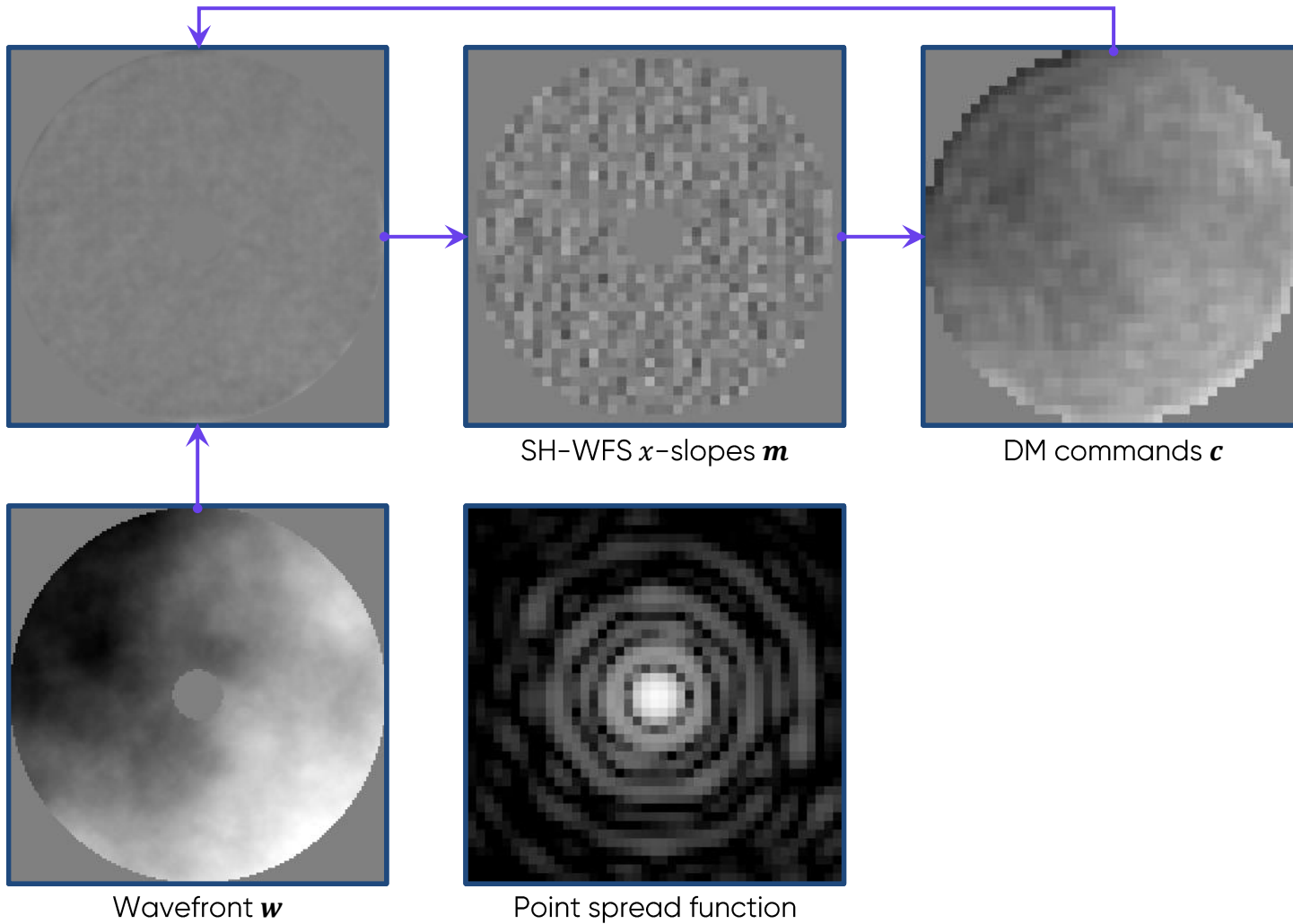

Closed loop – Mis-registration?

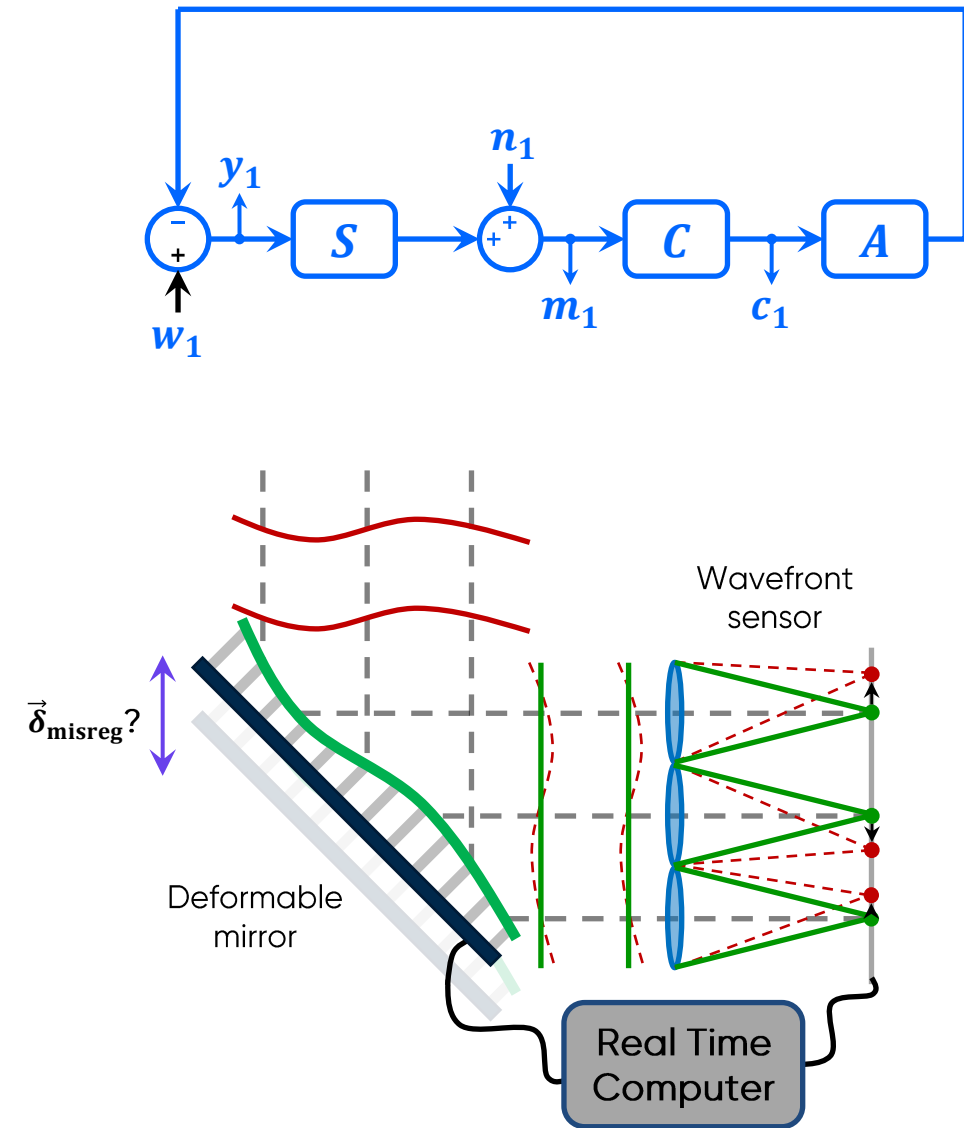
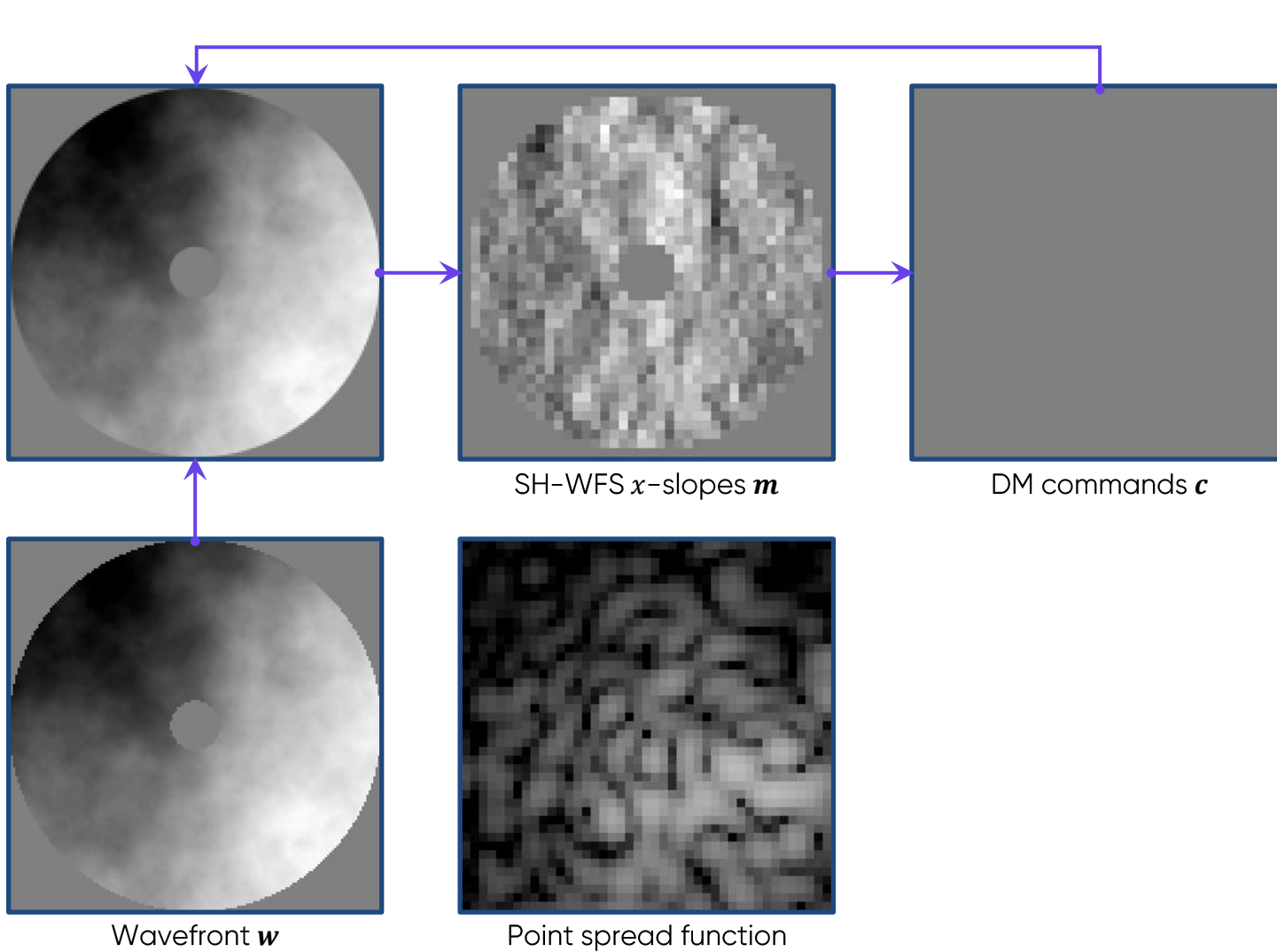

Closed loop – Mis-registration?

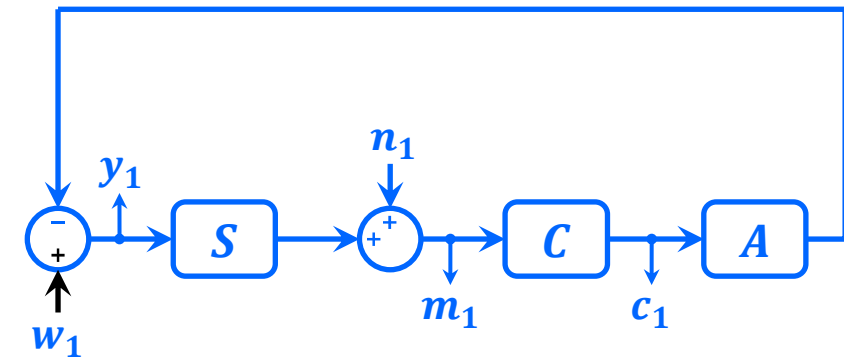
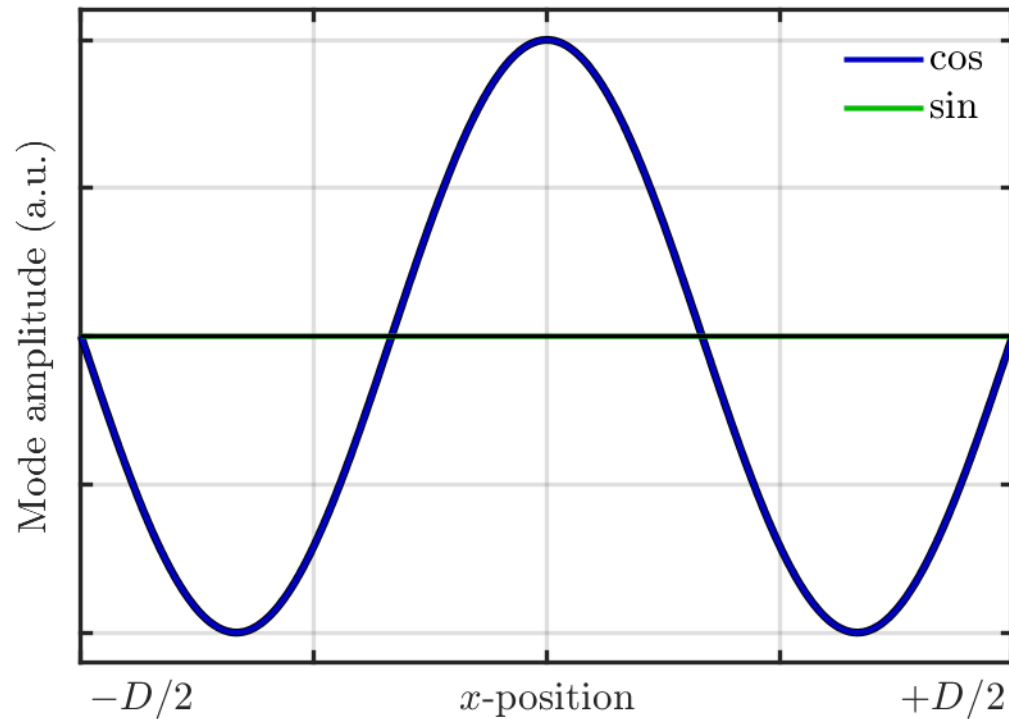

Closed loop – Mis-registration?

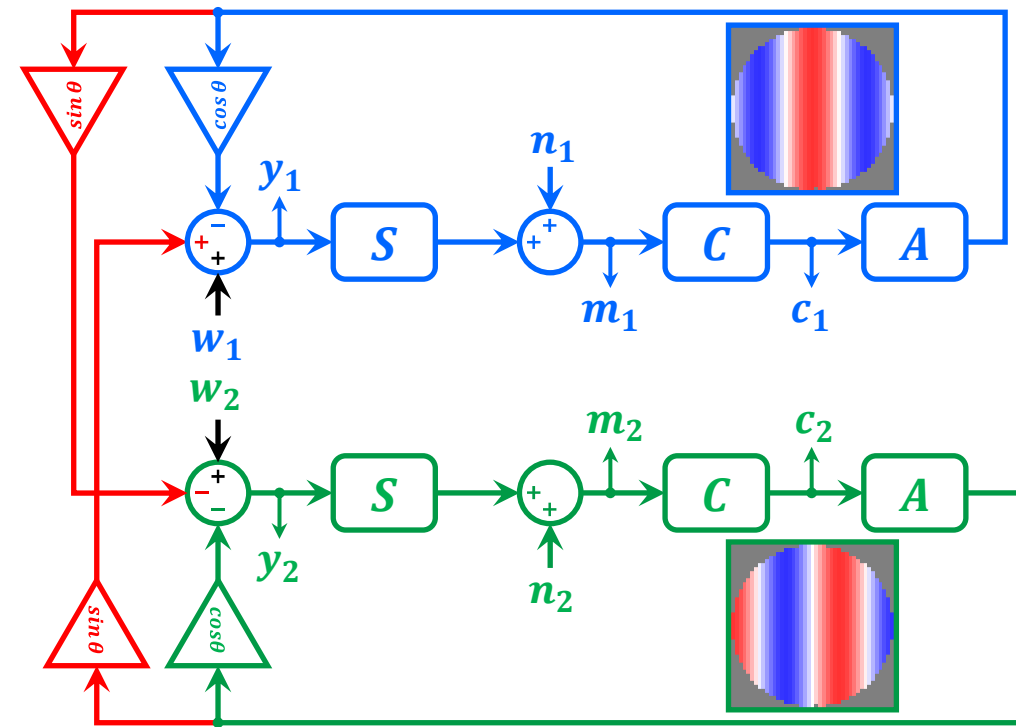
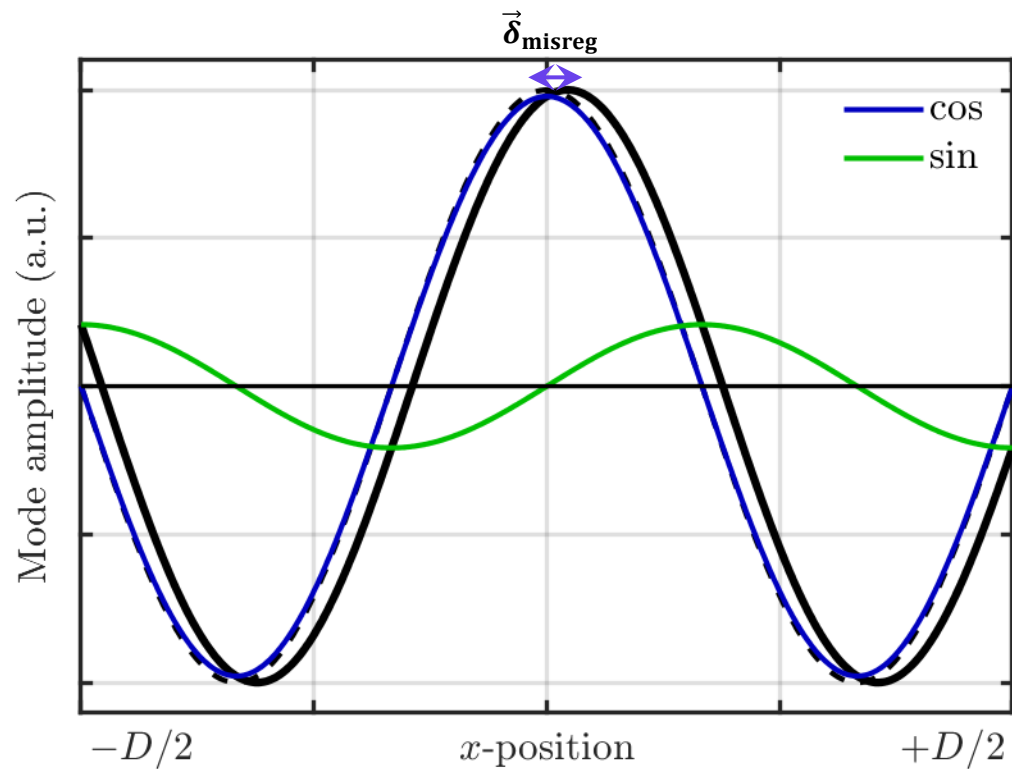

Closed loop – Mis-registration?

➤ Coupling coefficient θ between symmetric and anti-symmetric signal

- $\theta \propto \vec{\delta}_{\text{misreg}}$
- $\theta \propto \vec{k}_{2D}$

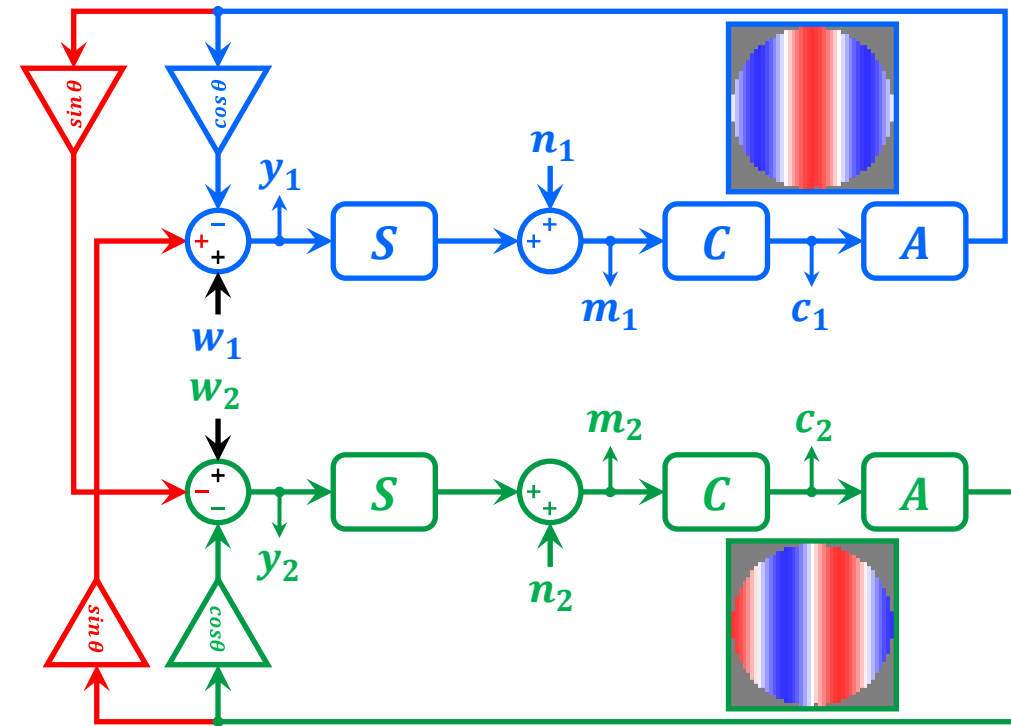
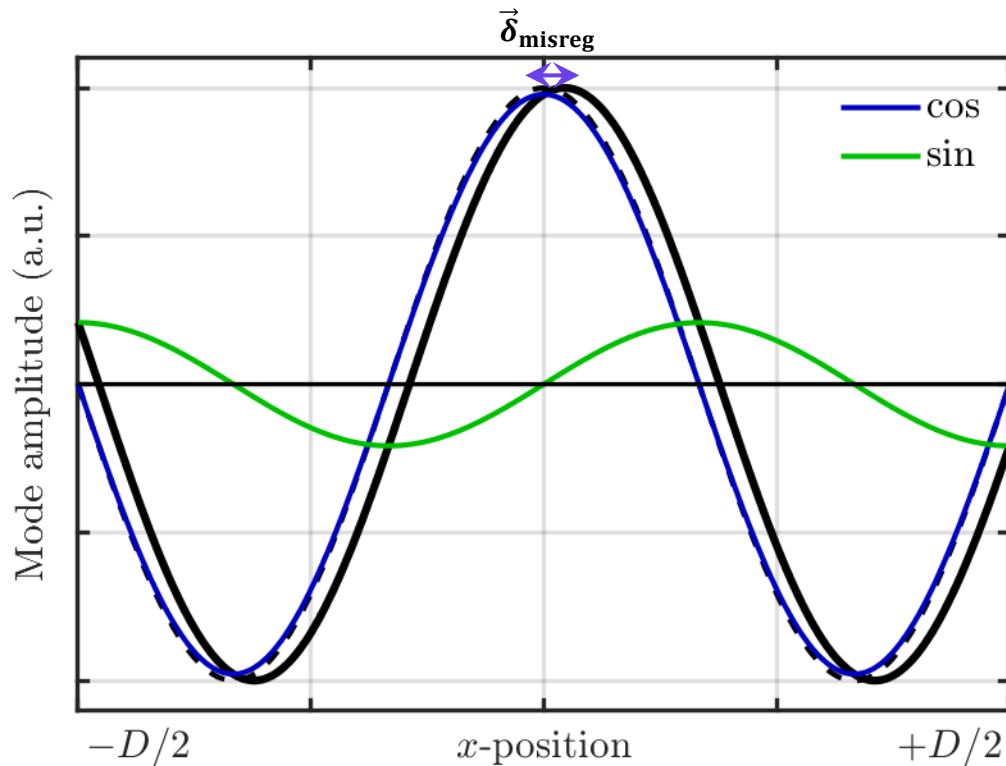

$$\theta = 2\pi \vec{k}_{2D} \cdot \vec{\delta}_{\text{misreg}}$$

Closed loop – Mis-registration?

➤ Coupling coefficient θ between symmetric and anti-symmetric signal

- $\theta \propto \vec{\delta}_{\text{misreg}}$
- $\theta \propto \vec{k}_{2D}$

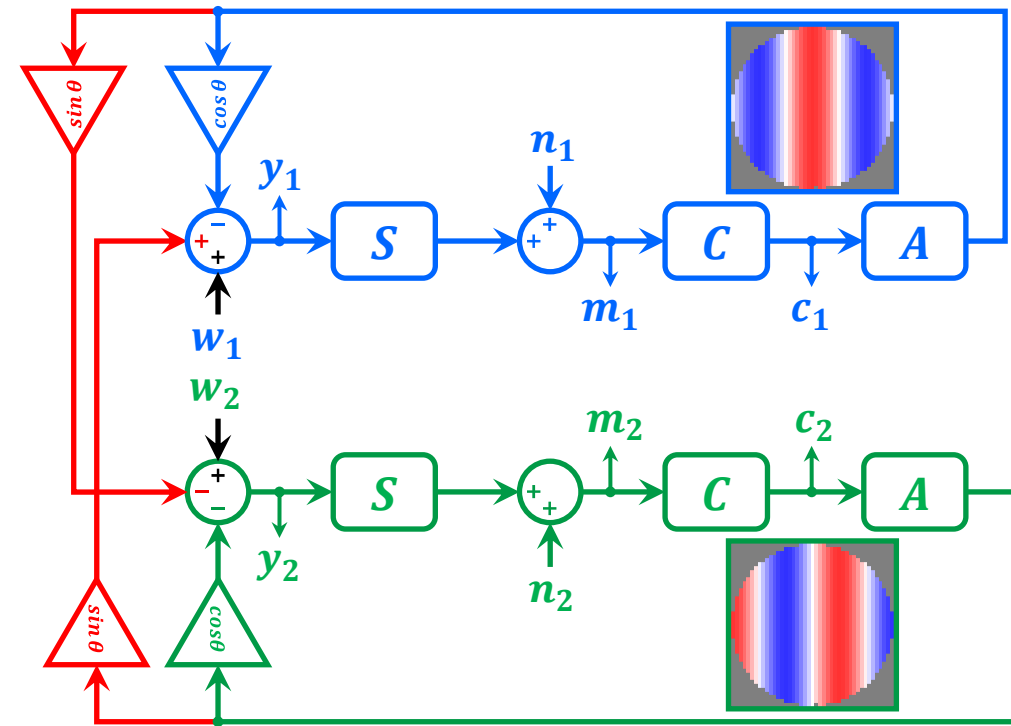
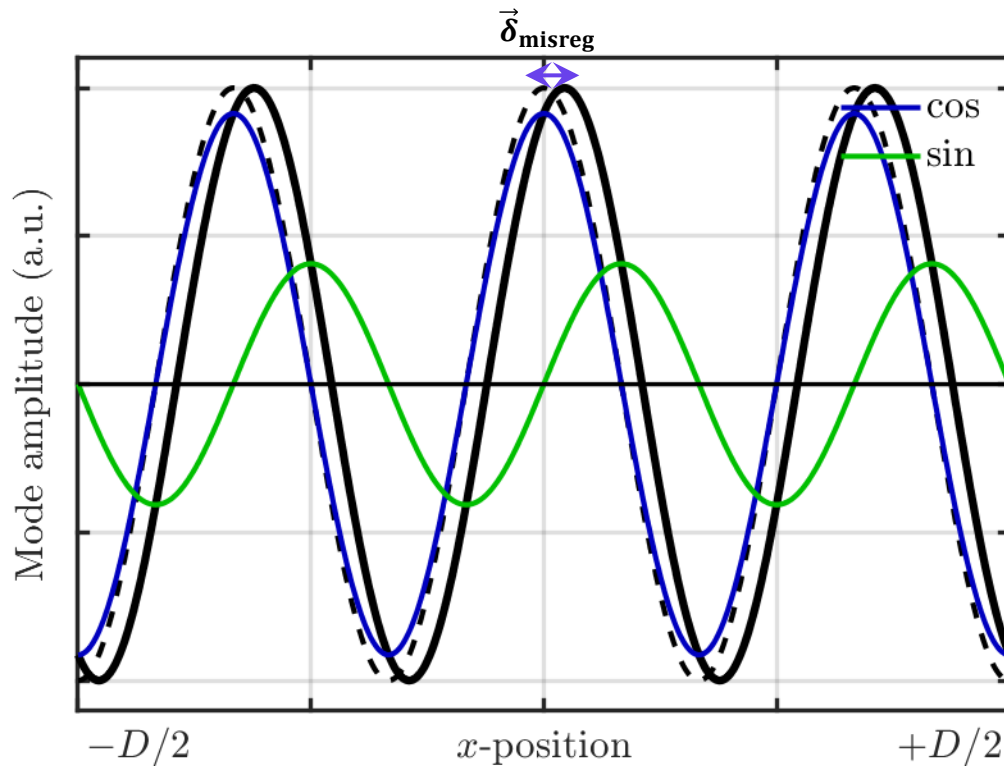

$$\theta = 2\pi \vec{k}_{2D} \cdot \vec{\delta}_{\text{misreg}}$$

Closed loop – Mis-registration?

➤ Coupling coefficient θ between symmetric and anti-symmetric signal

- $\theta \propto \vec{\delta}_{\text{misreg}}$
- $\theta \propto \vec{k}_{2D}$

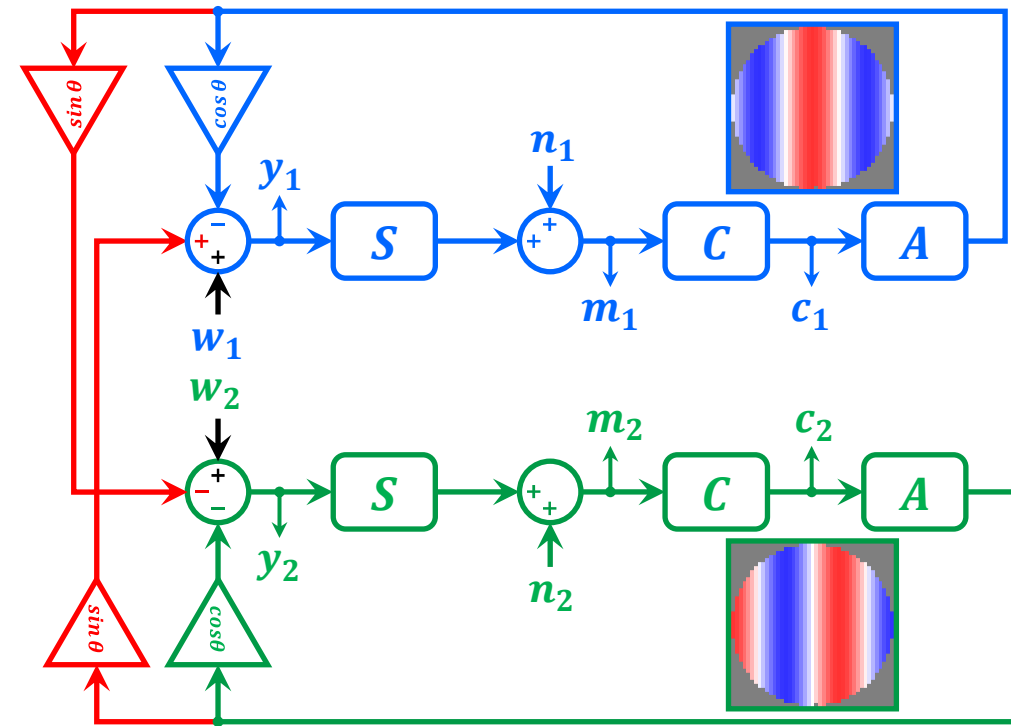
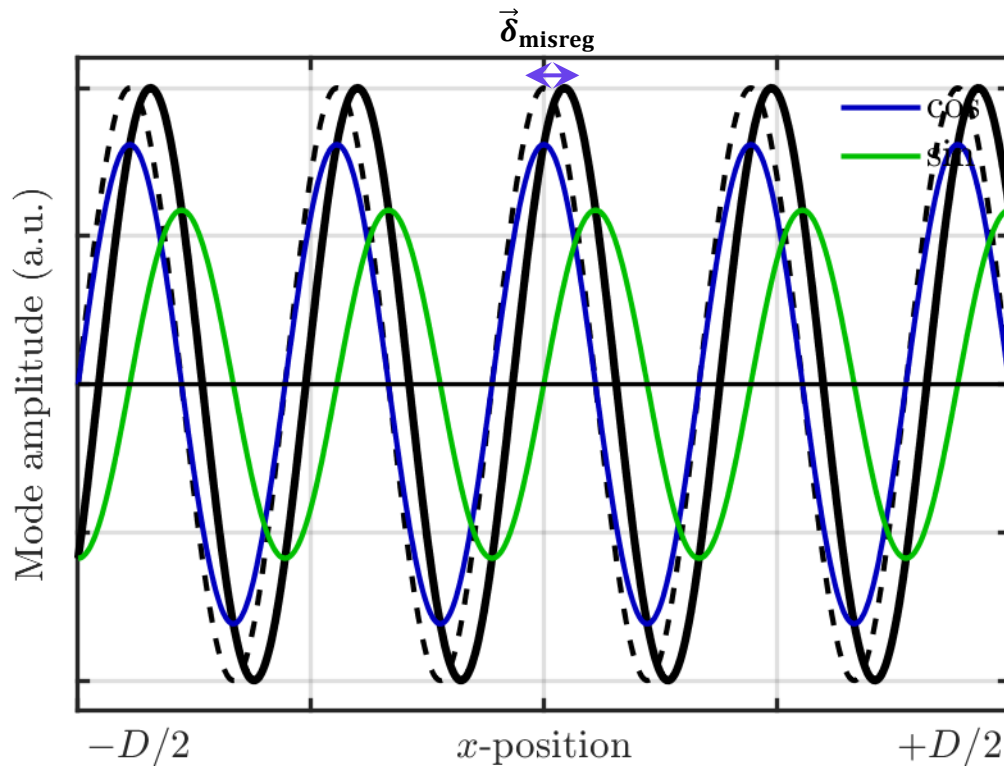

$$\theta = 2\pi \vec{k}_{2D} \cdot \vec{\delta}_{\text{misreg}}$$

Closed loop – Mis-registration?

➤ Coupling coefficient θ between symmetric and anti-symmetric signal

- $\theta \propto \vec{\delta}_{\text{misreg}}$
- $\theta \propto \vec{k}_{2D}$

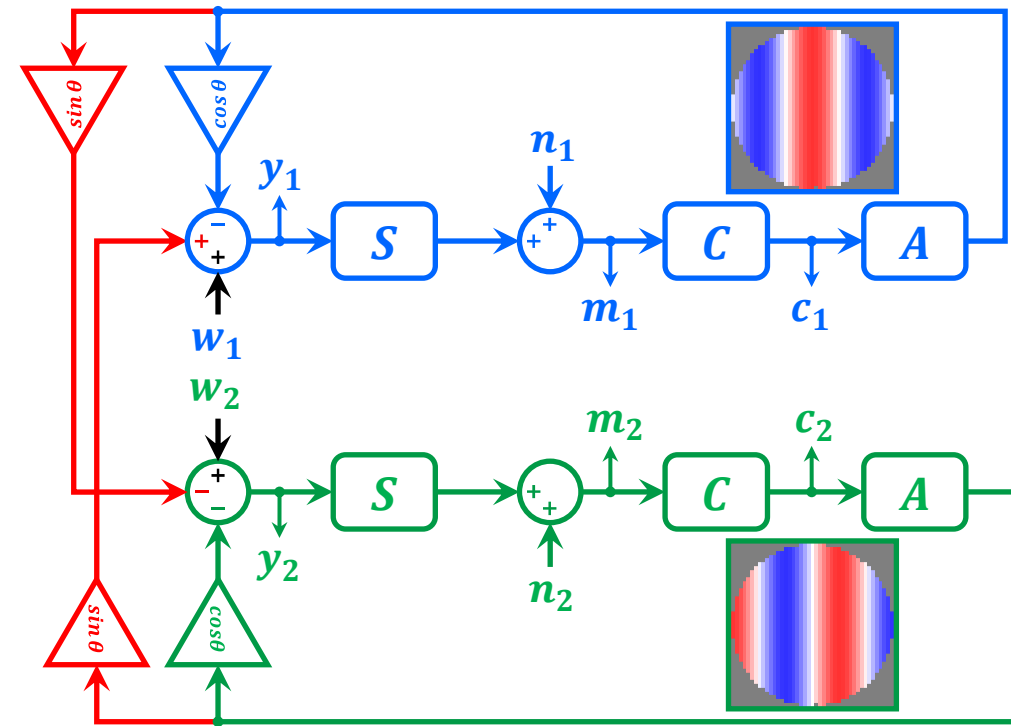
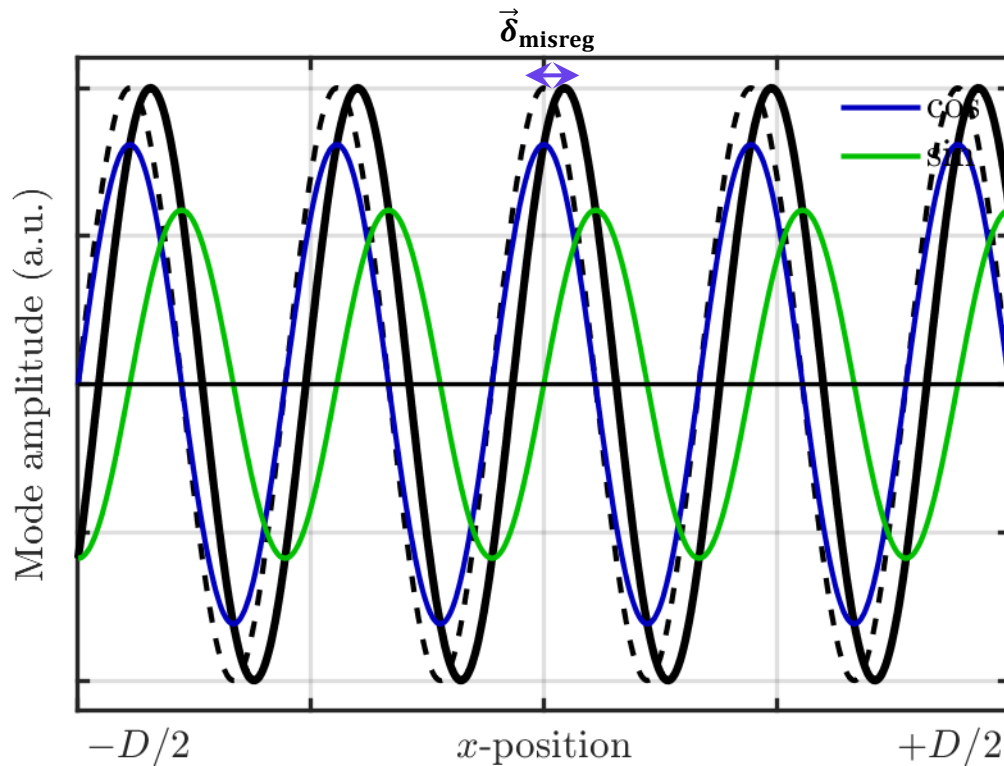

$$\theta = 2\pi \vec{k}_{2D} \cdot \vec{\delta}_{\text{misreg}} \implies 2D$$

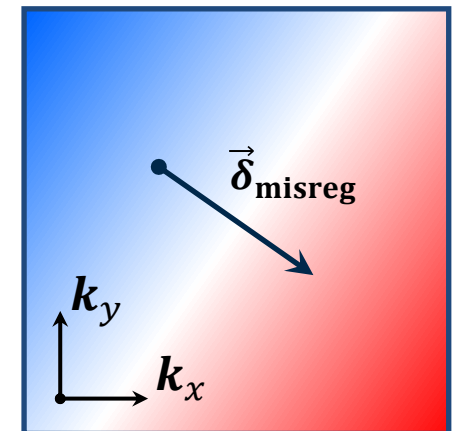

Closed loop – Mis-registration?

- Coupling coefficient θ between symmetric and anti-symmetric signal
 - $\theta \propto \vec{\delta}_{\text{misreg}}$
 - $\theta \propto \vec{k}_{2D}$
- How to find θ ? \Rightarrow Noise limited regime: command temporal correlation
 - $C_{c_1, c_2} = \frac{\langle c_1 \bar{c}_2 \rangle}{\sqrt{\langle |c_1|^2 \rangle \langle |c_2|^2 \rangle}}$
 - In Fourier space: $C_{c_1, c_2}(f) \xrightarrow{\theta \rightarrow 0} \theta C_0(f)$

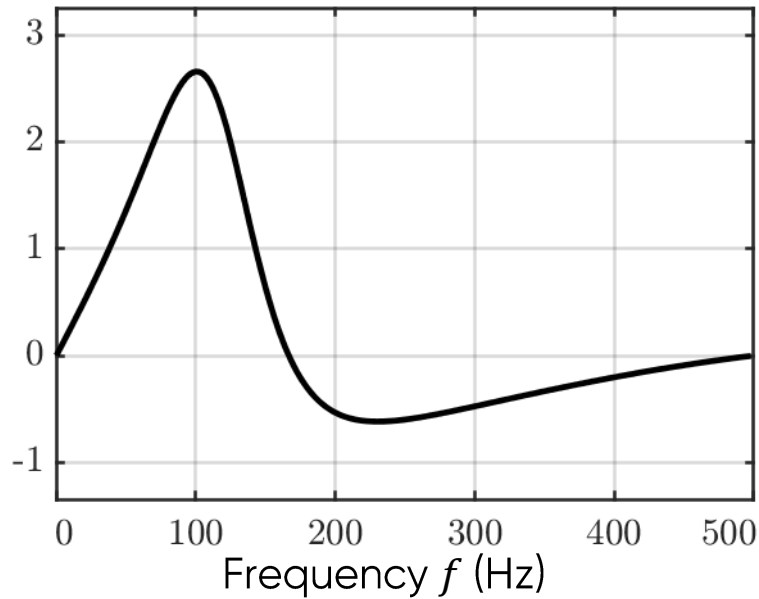

- With $C_0(f) = 2 i \text{Imag} \left(\frac{\bar{\mu}(f)}{1+\bar{\mu}(f)} \right)$ with $\mu(f) = S(f)C(f)A(f)$
- $C_0(f)$ only depends on τ^{loop} , τ^{latency} and g^{loop}

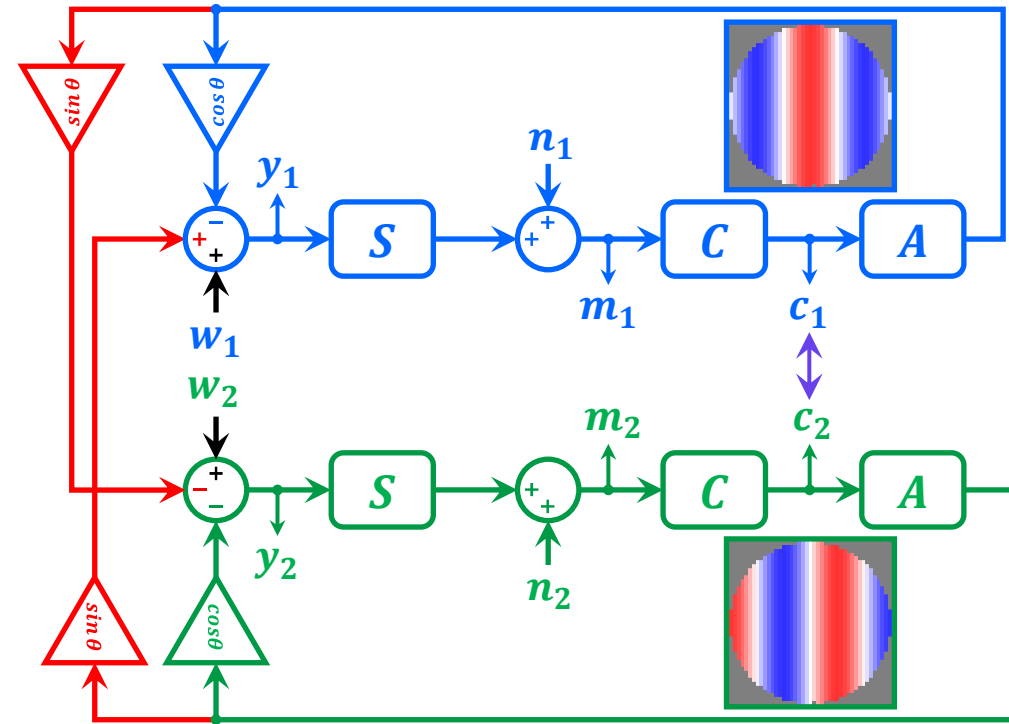

$$\theta = 2\pi \vec{k}_{2D} \cdot \vec{\delta}_{\text{misreg}} \Rightarrow 2D$$

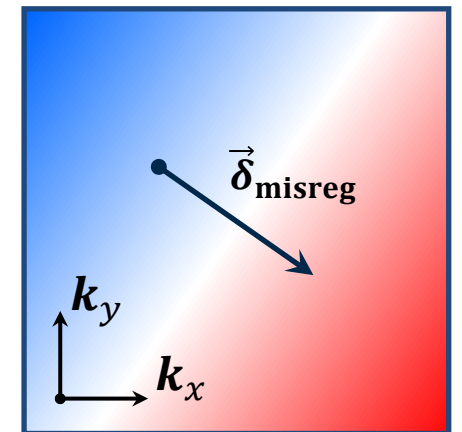

Closed loop – Mis-registration?

- Coupling coefficient θ between symmetric and anti-symmetric signal
 - $\theta \propto \vec{\delta}_{\text{misreg}}$
 - $\theta \propto \vec{k}_{2D}$
- How to find θ ? \Rightarrow Noise limited regime: command temporal correlation
 - $C_{c_1, c_2} = \frac{\langle c_1 \bar{c}_2 \rangle}{\sqrt{\langle |c_1|^2 \rangle \langle |c_2|^2 \rangle}}$
 - In Fourier space: $C_{c_1, c_2}(f) \xrightarrow{\theta \rightarrow 0} \theta C_0(f)$

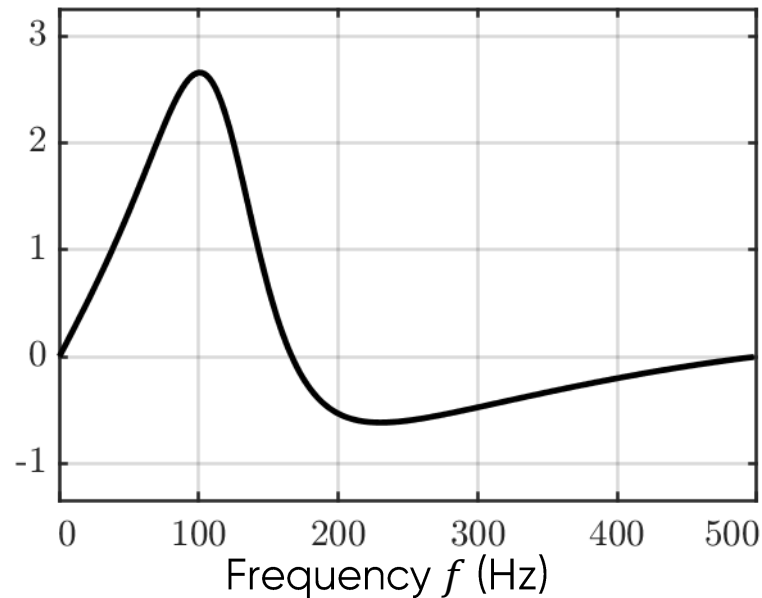

- With $C_0(f) = 2 i \text{Imag} \left(\frac{\bar{\mu}(f)}{1+\bar{\mu}(f)} \right)$ with $\mu(f) = S(f)C(f)A(f)$
- $C_0(f)$ only depends on τ^{loop} , τ^{latency} and g^{loop}

- Take home messages:
 - Mis-registration \Rightarrow coupling of the symmetric and anti-symmetric parts of the commands
 - Signal in the telemetry temporal correlation
 - No interaction matrix model needed
 - Sparse in the Fourier domain
 - Theoretical negligible bias by the wind.
- More in the proceeding + A&A paper

$$\theta = 2\pi \vec{k}_{2D} \cdot \vec{\delta}_{\text{misreg}} \quad \Rightarrow \quad 2D$$

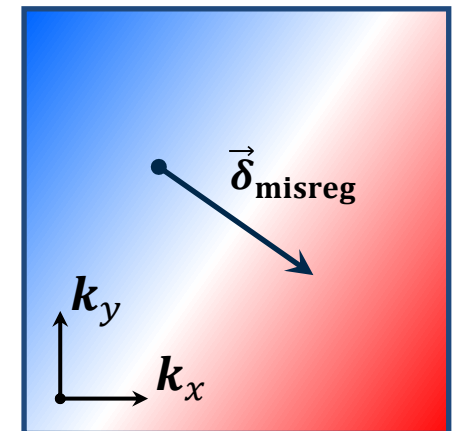

Bench results – In the GPAO bench

1. Closed loop / lateral mis-registration
2. Corrective loop is active
3. A few screenshots from the bench

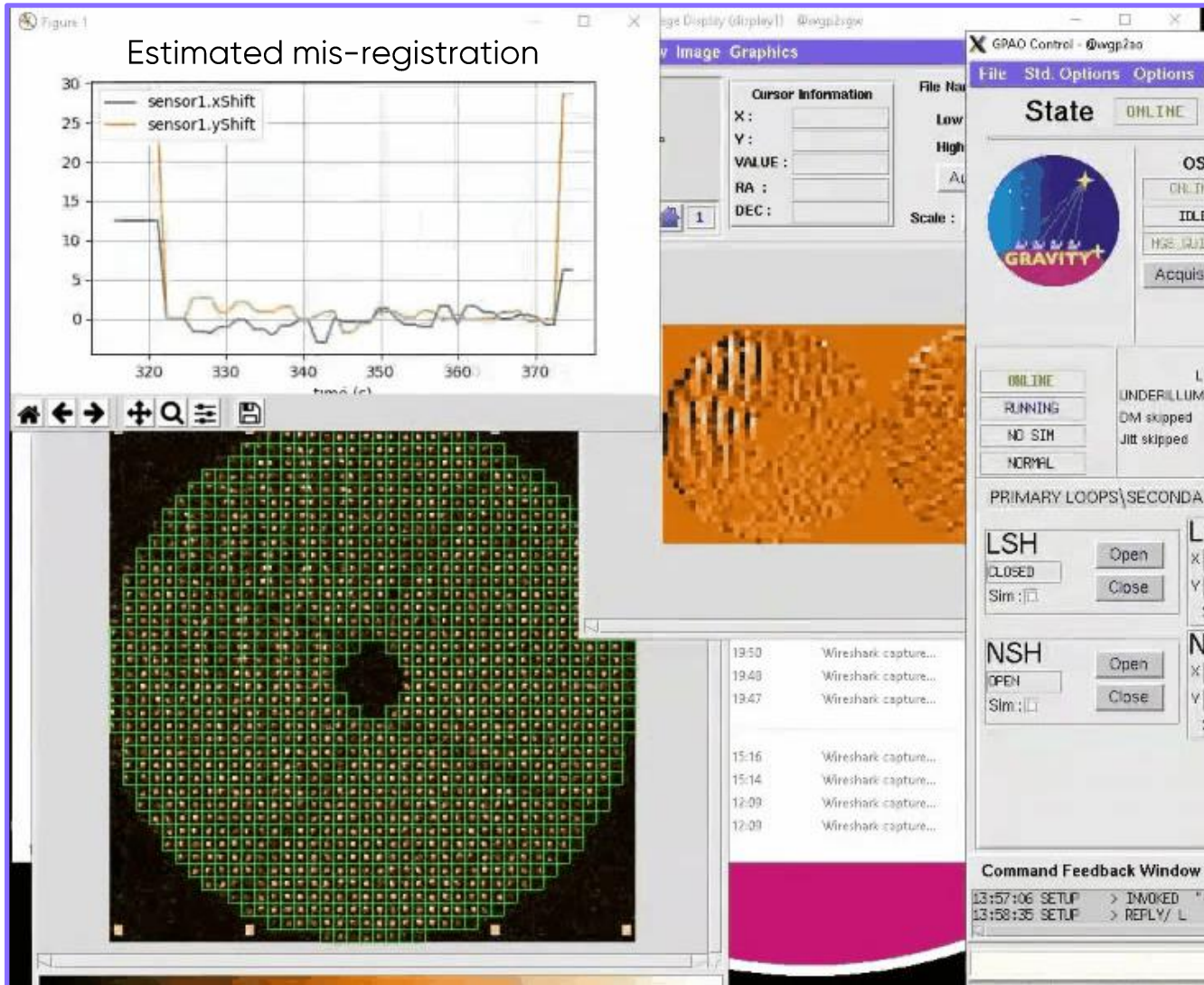

WFS motor stage
(% of subaperture)

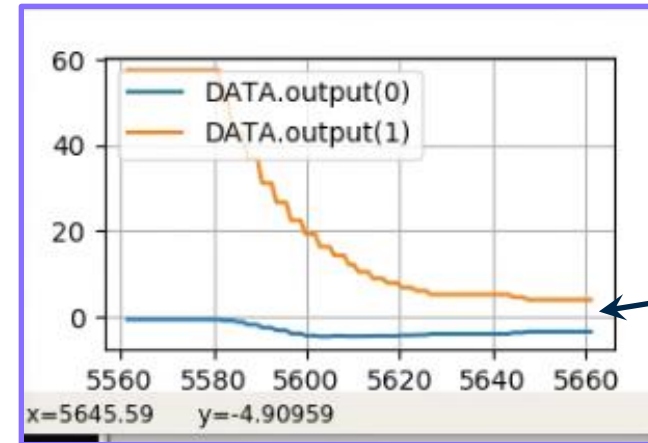

Mis-registration update

Bench results – In the GPAO bench

1. Closed loop / lateral mis-registration
2. Corrective loop is active
3. A few screenshots from the bench

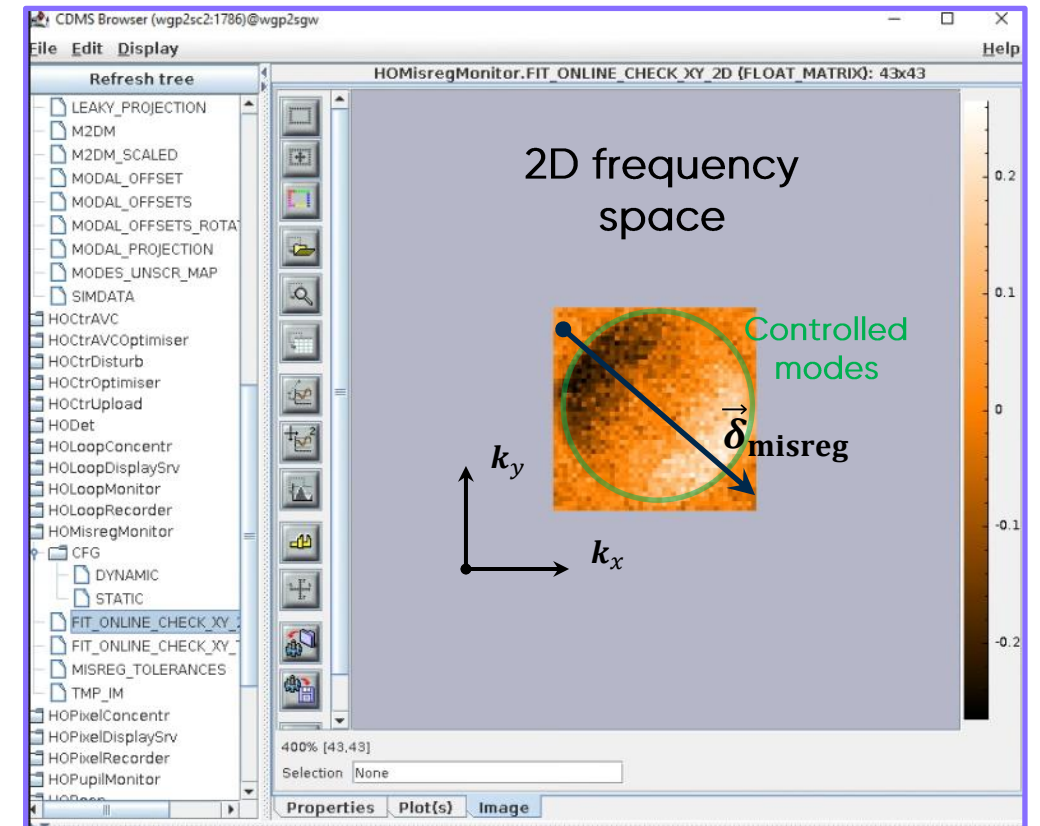
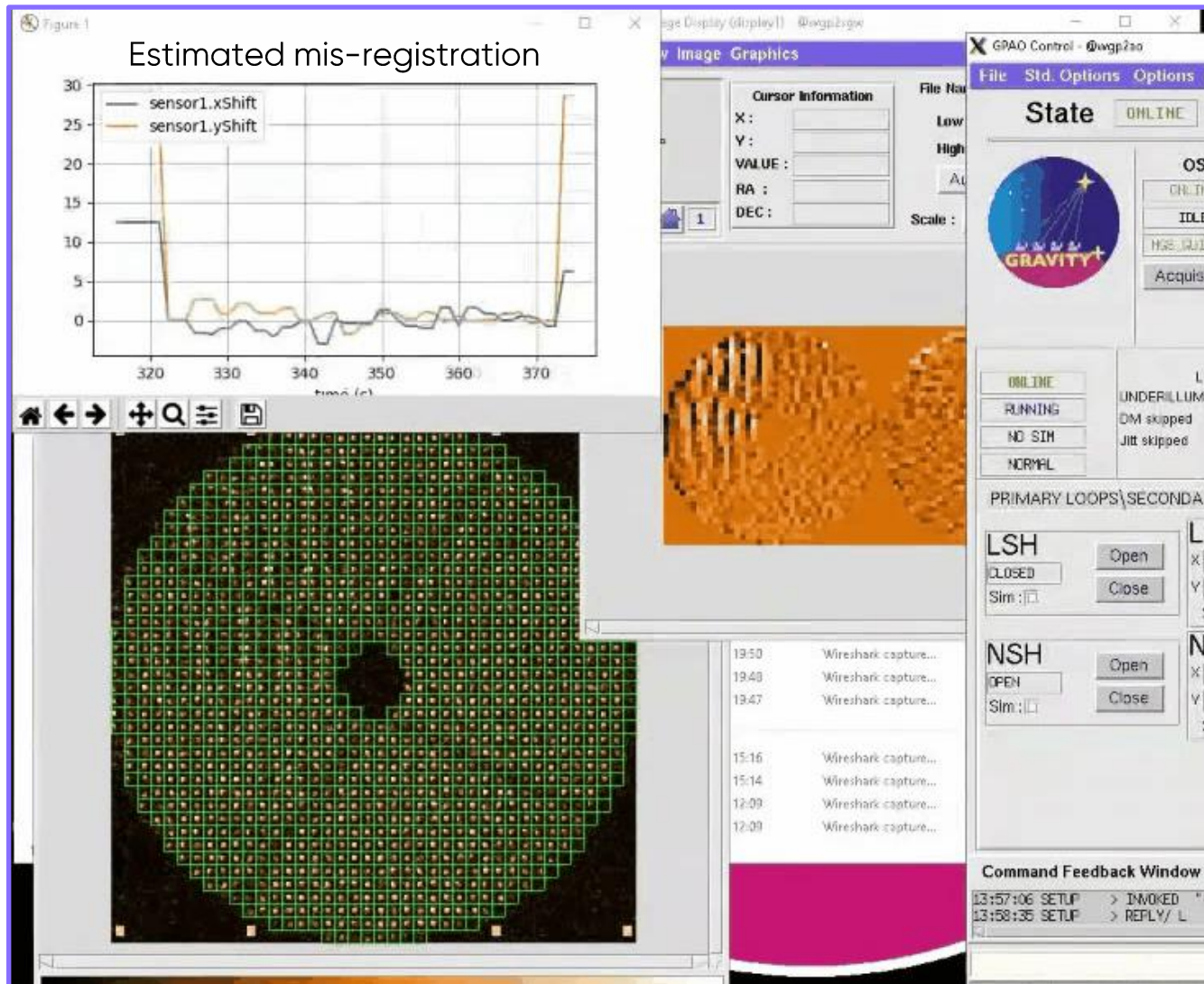

The infamous SPARTA CDMS browser

Bench results – In the GPAO bench

1. Closed loop / lateral mis-registration
2. Corrective loop is active
3. A few screenshots from the bench

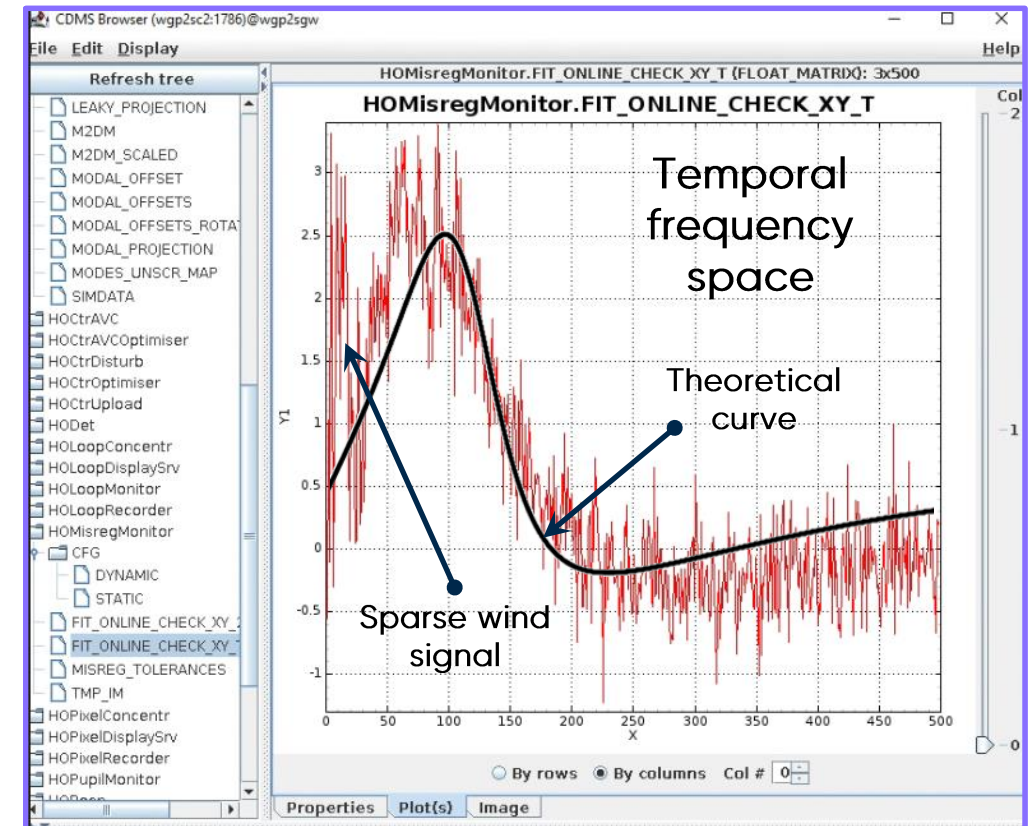
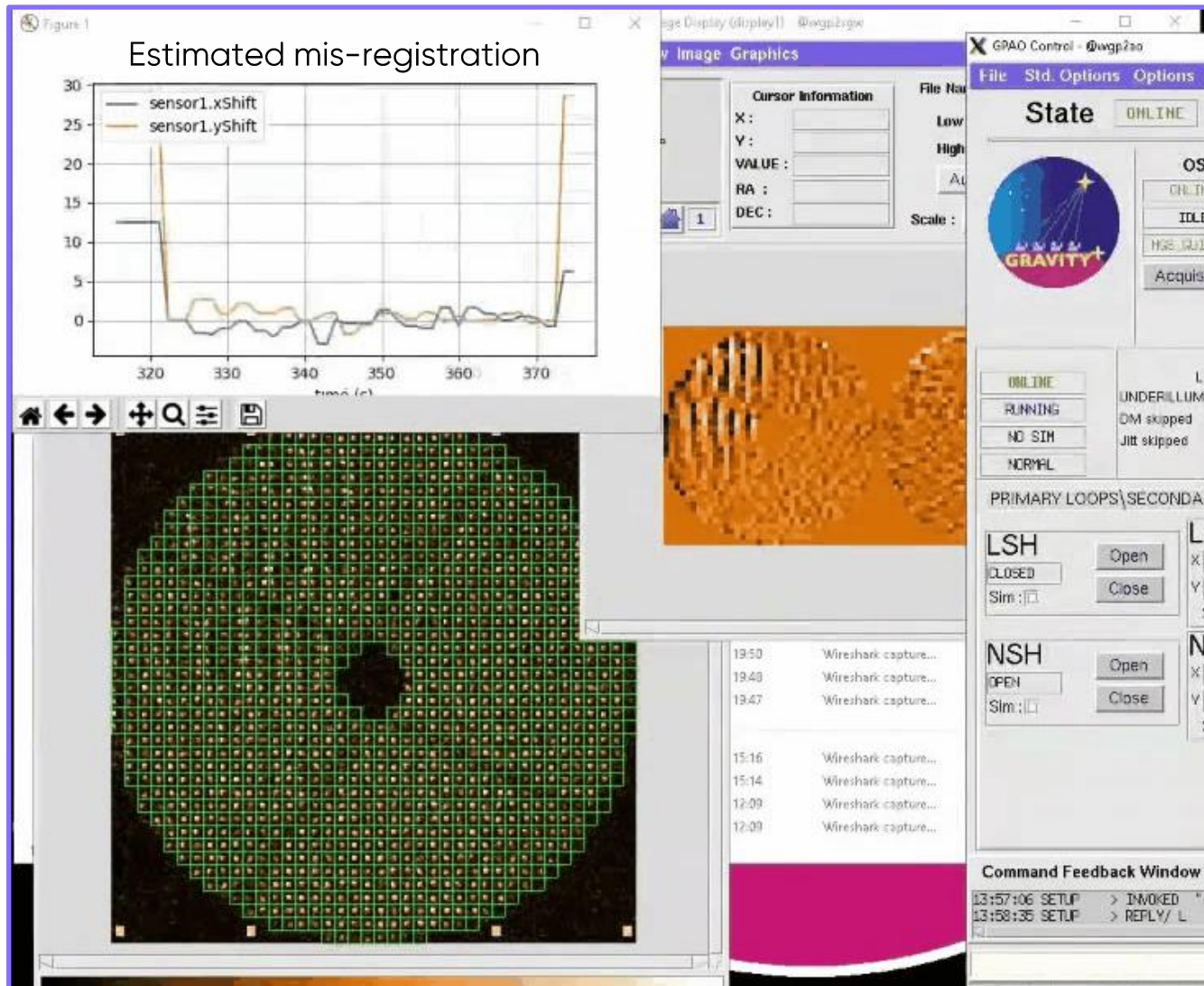

The infamous SPARTA CDMS browser

On-sky results – CHARA

Influence function of a single actuator

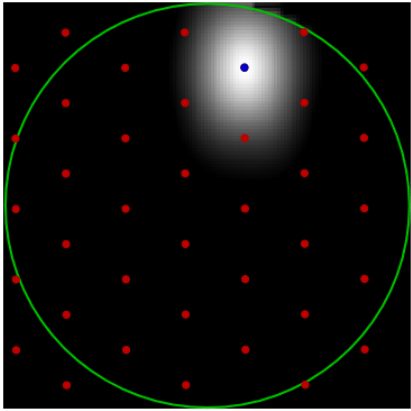

Maximal projection of all influence functions

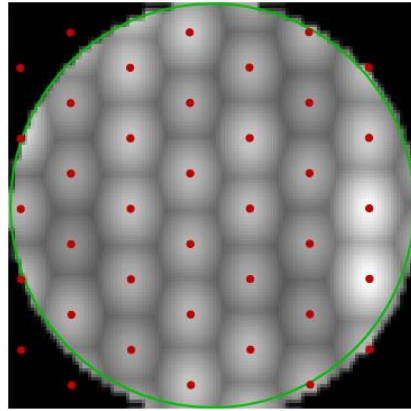

⇒ Problem: non-Cartesian grid for the commands

Low resolution model

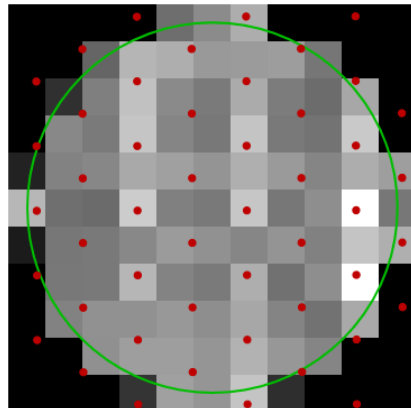
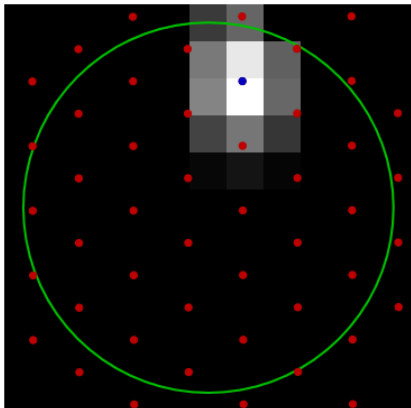

⇒ Solution: low resolution grid (~ 1.5 pix / actuator)

On-sky results – CHARA

Influence function of a single actuator

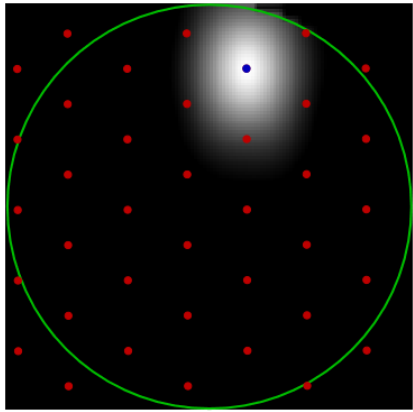

Maximal projection of all influence functions

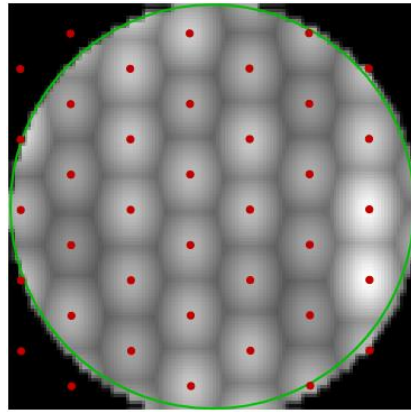

⇒ Problem: non-Cartesian grid for the commands

Low resolution model

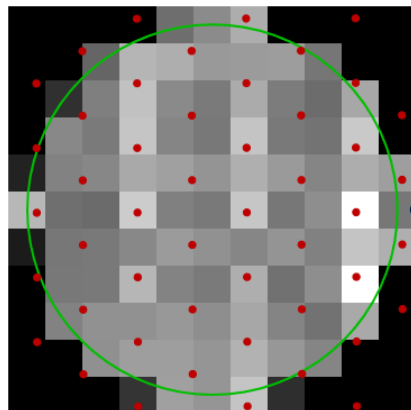
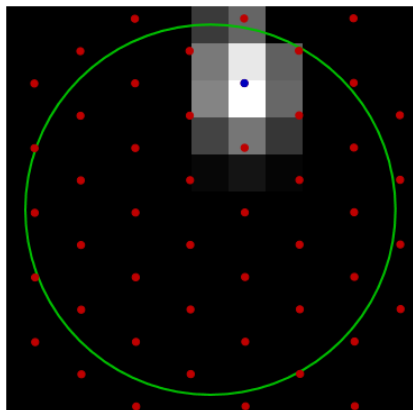

⇒ Solution: low resolution grid (~1.5 pix / actuator)

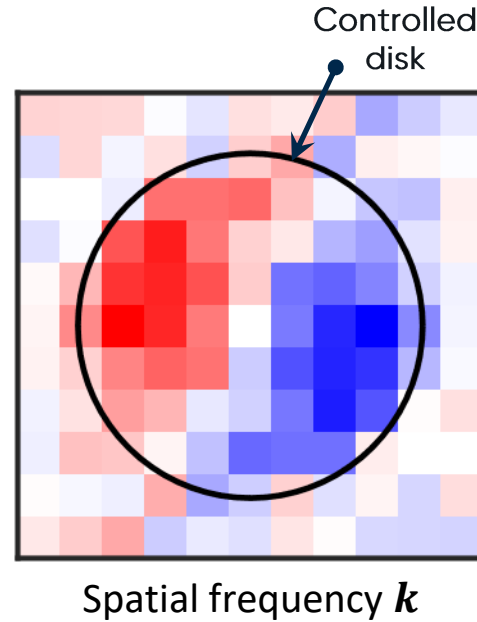

Spatial frequency k

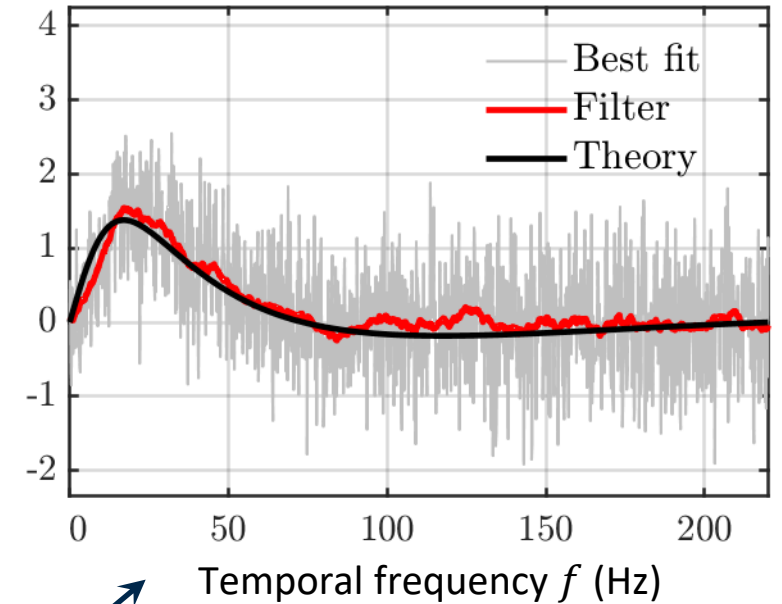

Loop frequency: 441 Hz
 Loop gain: 0.19
 Number of controlled modes: 41

Command telemetry

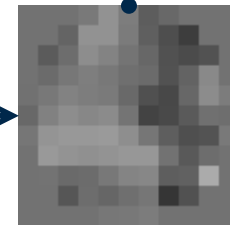

On-sky results – CHARA

Influence function of a single actuator

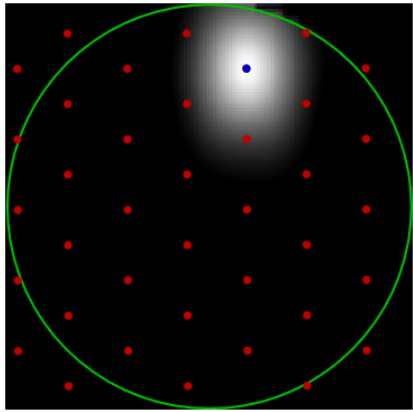

Maximal projection of all influence functions

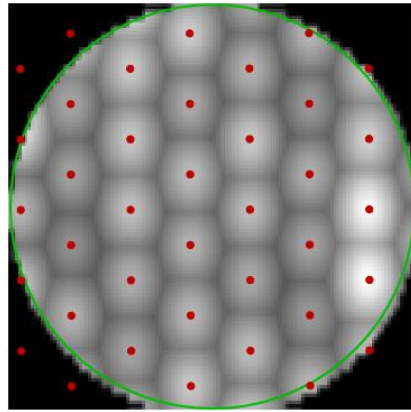

⇒ Problem: non-Cartesian grid for the commands

Low resolution model

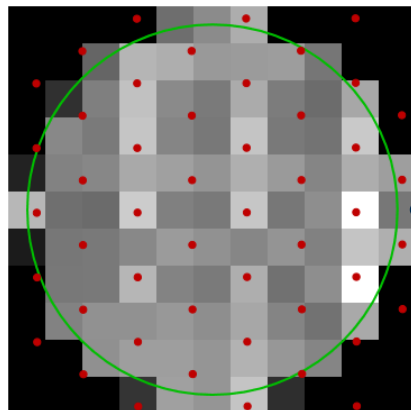
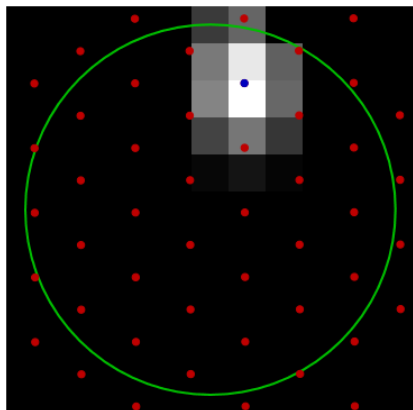

⇒ Solution: low resolution grid (~1.5 pix / actuator)

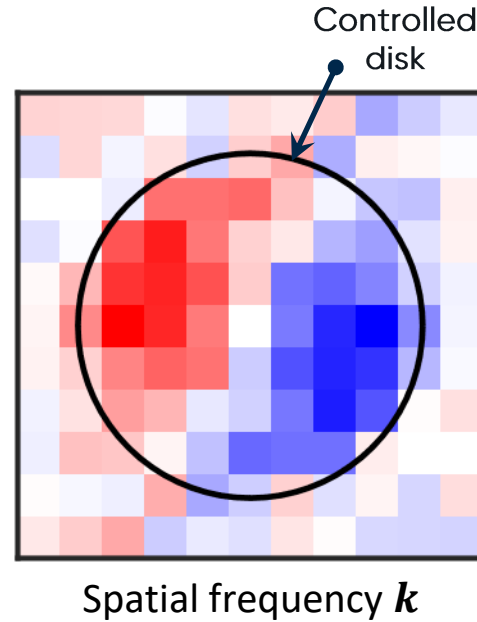

Spatial frequency k

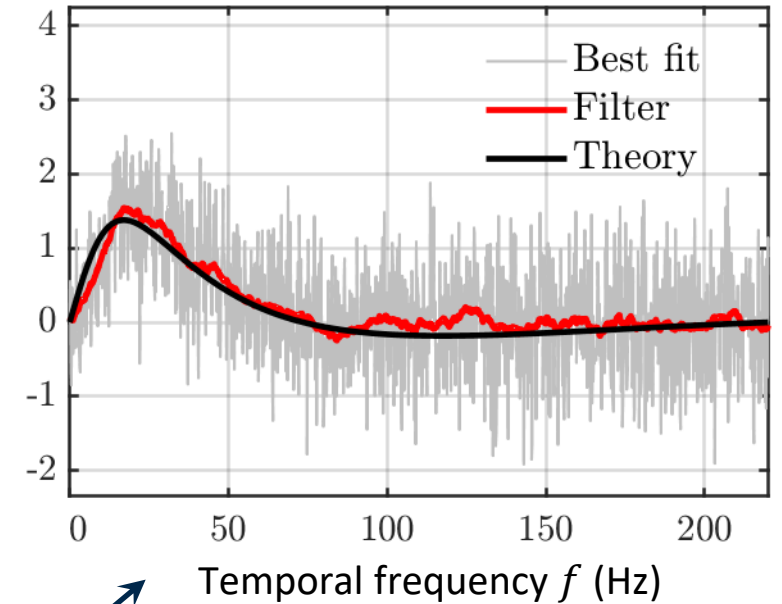

Temporal frequency f (Hz)

Loop frequency: 441 Hz
 Loop gain: 0.19
 Number of controlled modes: 41

- Take home messages:
 - 2D map of the spatial frequency correlation coefficient ⇒ OK!
 - Temporal correlation curve ⇒ OK!

On-sky results – CIAO (GRAVITY)

Influence function of a single actuator

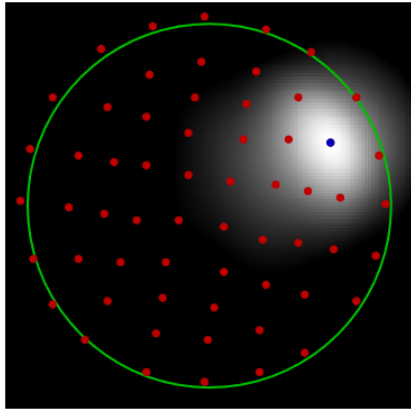

Maximal projection of all influence functions

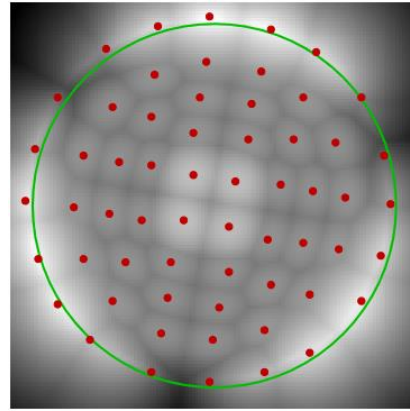

⇒ Problem: non-Cartesian grid for the commands

Low resolution model

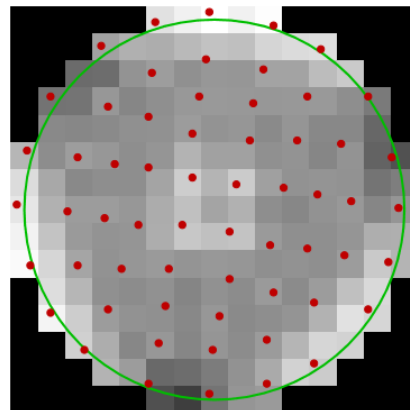
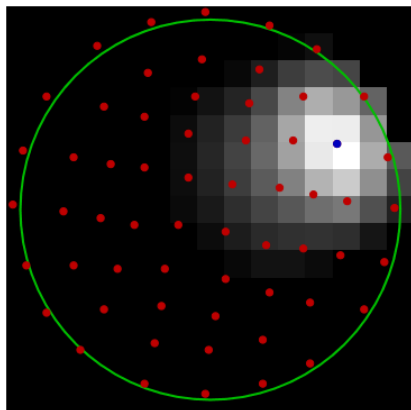

⇒ Solution: low resolution grid (~1.5 pix / actuator)

Command telemetry

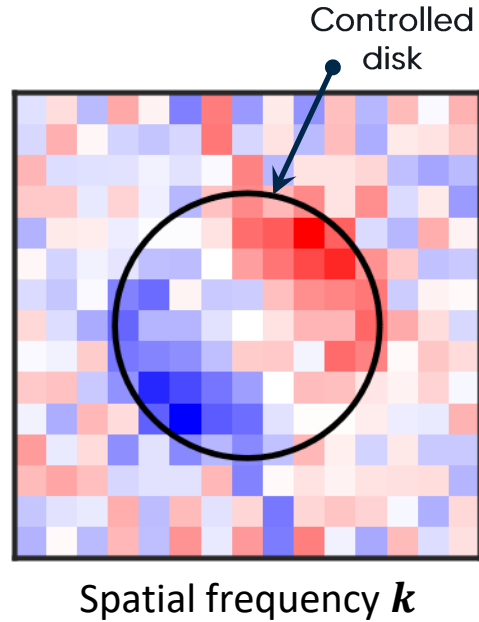

Spatial frequency k

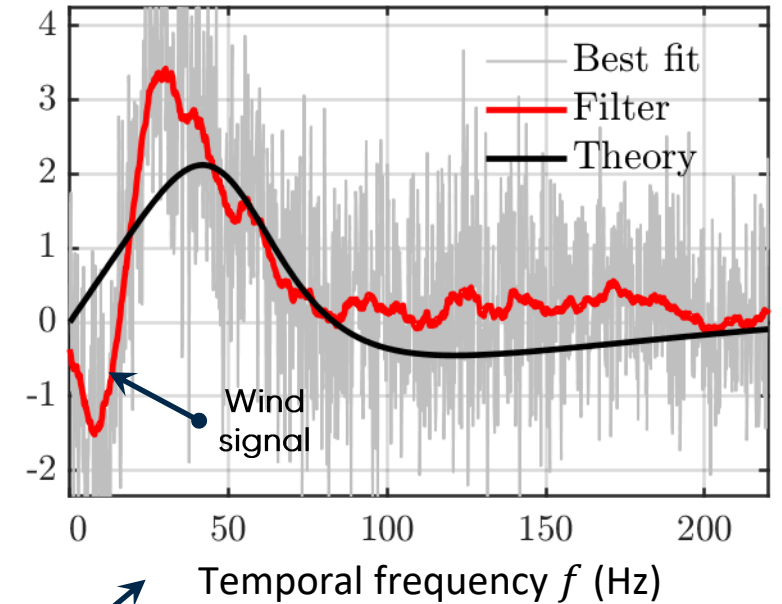

Loop frequency: 500 Hz
 Loop gain: 0.4
 Number of controlled modes: 45

- Take home messages:
 - 2D map of the spatial frequency correlation coefficient ⇒ OK!
 - Temporal correlation curve ⇒ OK!
- Any turbulence bias?

On-sky results – CIAO (GRAVITY)

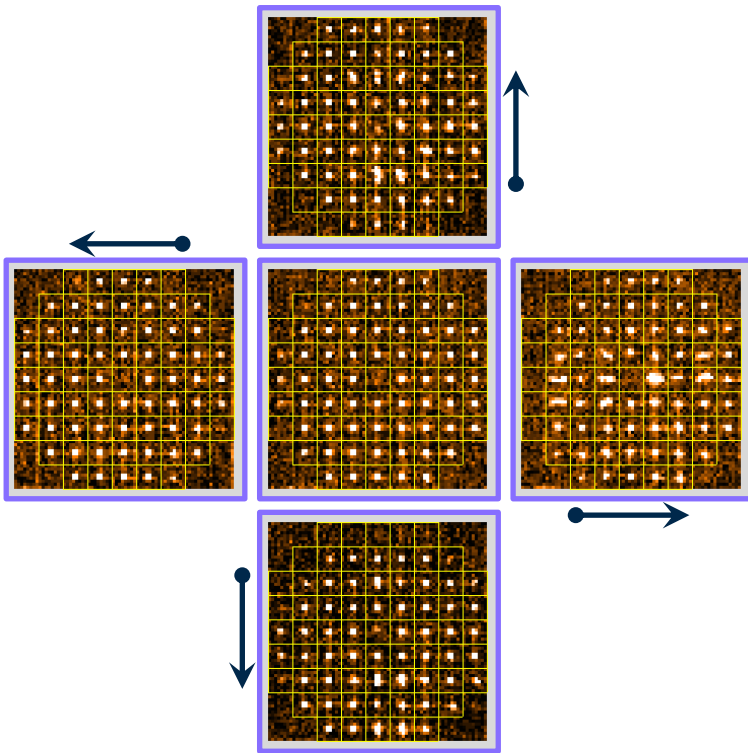

⇒ Applying known offsets
on each axis

On-sky results – CIAO (GRAVITY)

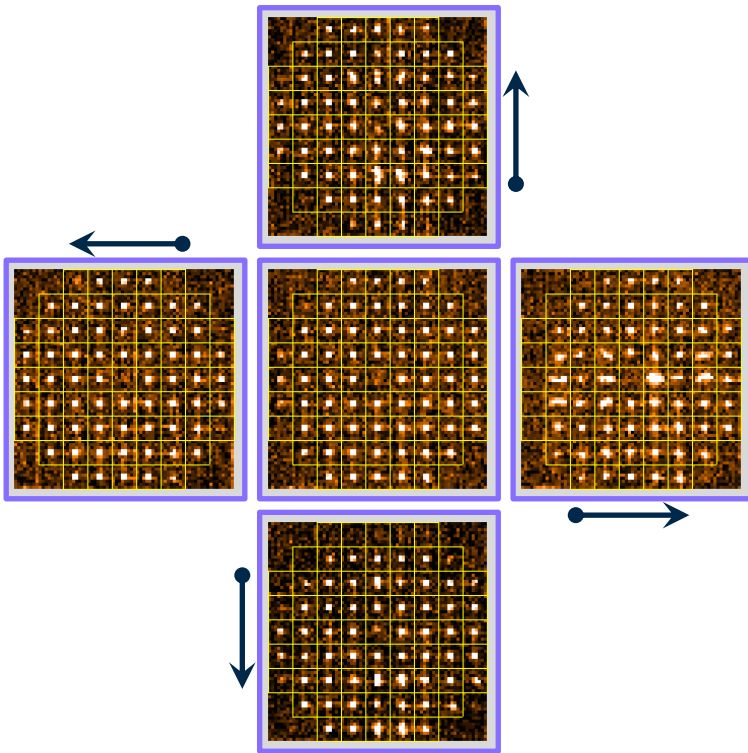

⇒ Applying known offsets on each axis

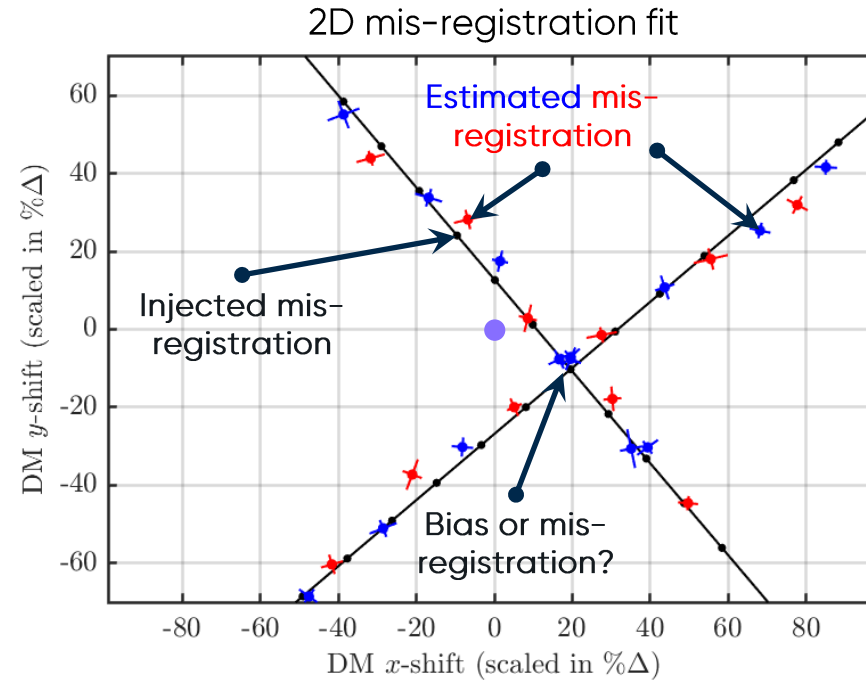

On the VLT beacon
(no turbulence)

On-sky results – CIAO (GRAVITY)

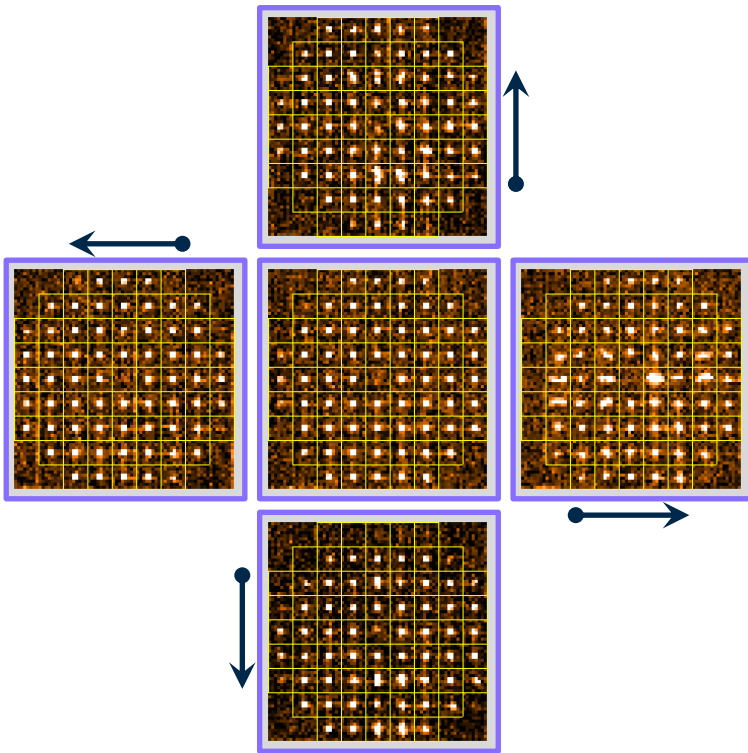

⇒ Applying known offsets on each axis

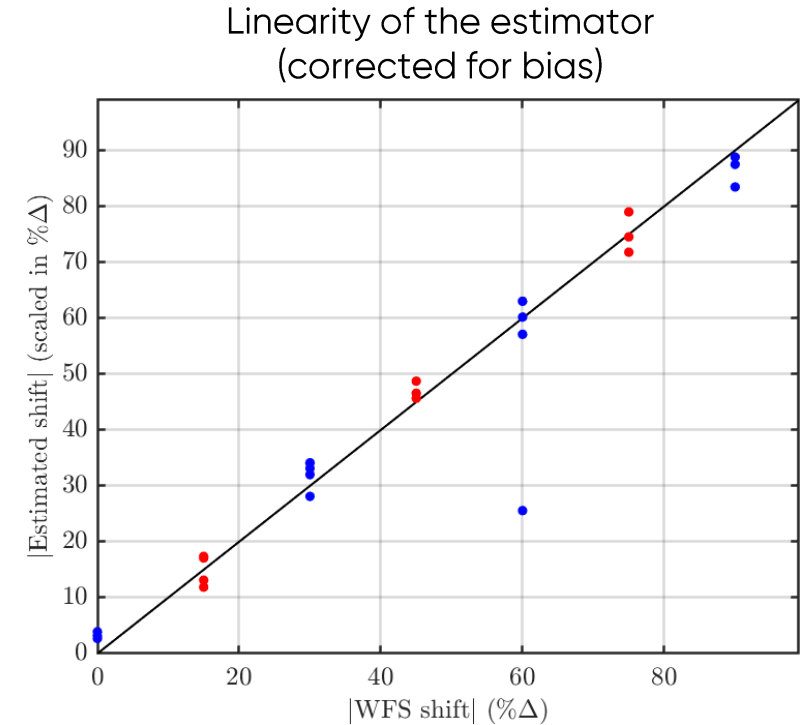
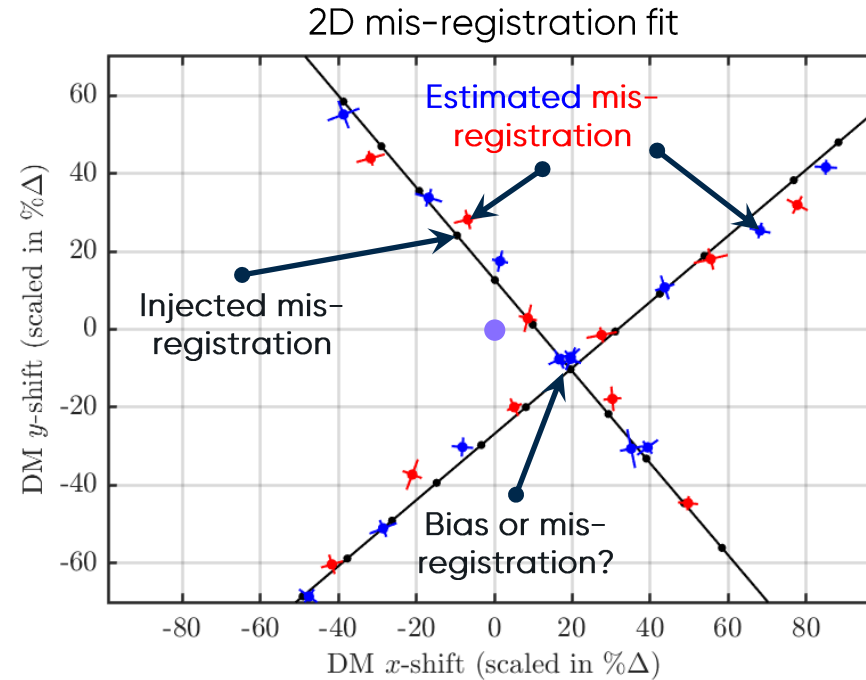

On the VLT beacon
(no turbulence)

On-sky results – CIAO (GRAVITY)

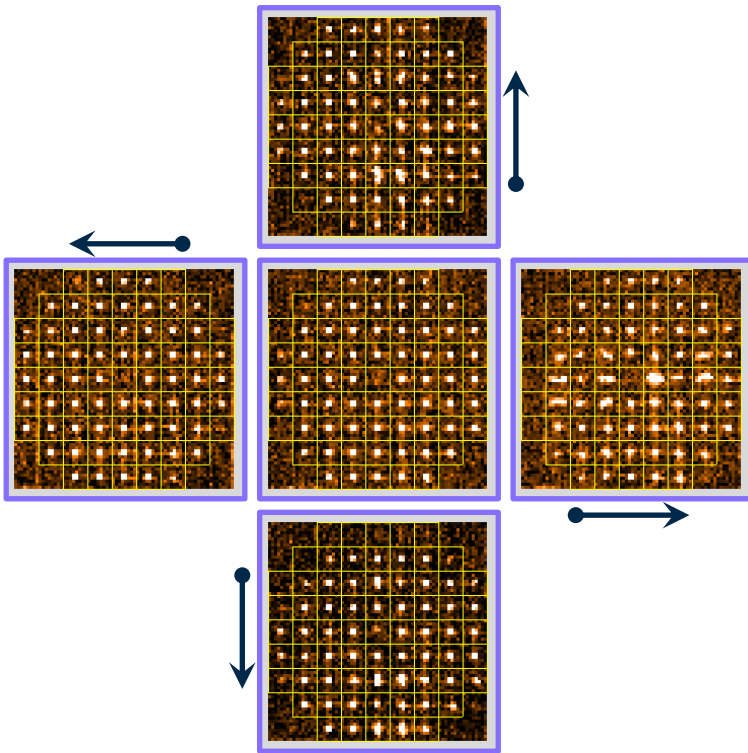

⇒ Applying known offsets on each axis

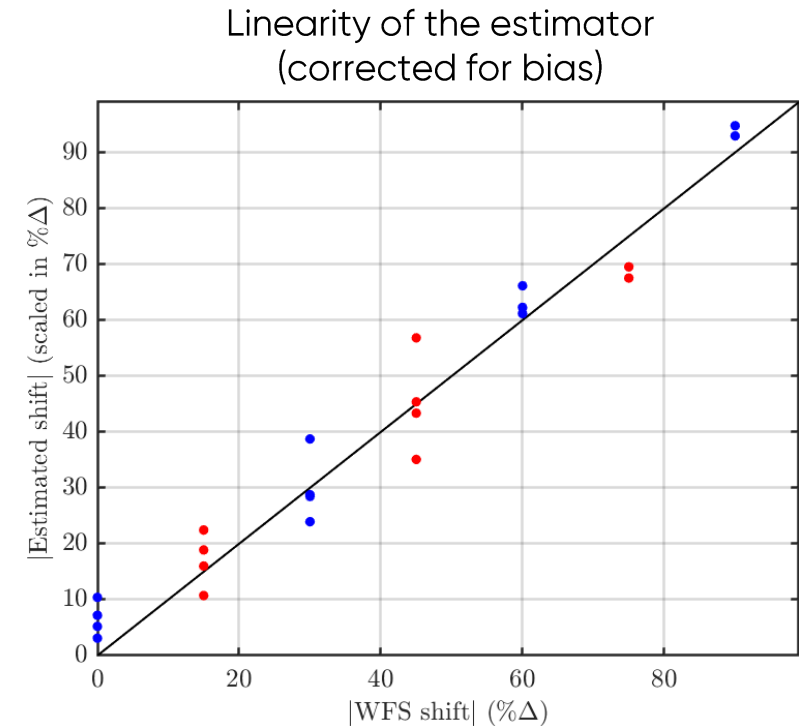
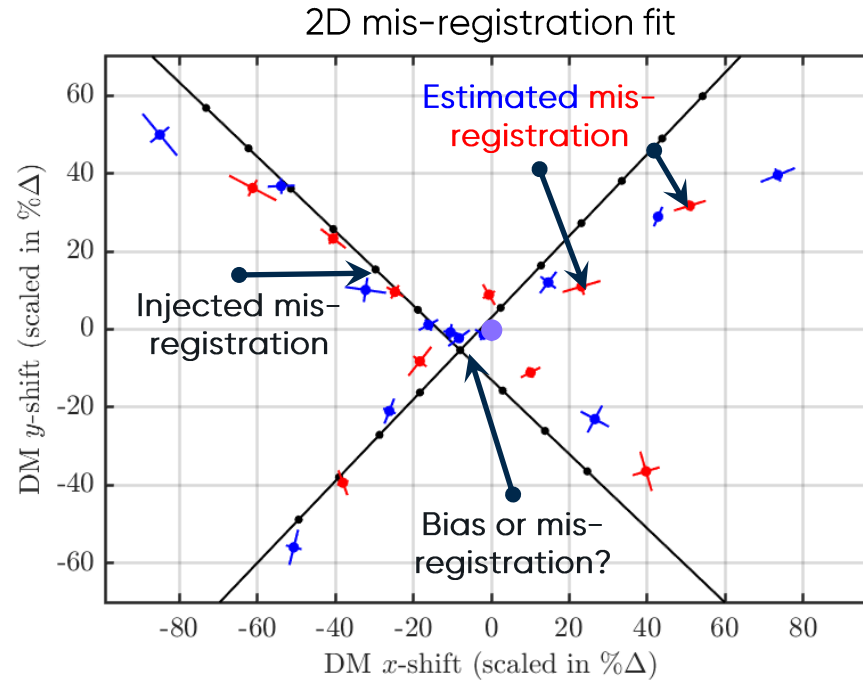

On the a 7 magnitude star (seeing $\approx 0.6''$)

⇒ Noisier (normal)
 ⇒ No visible bias (amplitude is consistent with the beacon)



- An open loop **perturbative 2D modal method**:
 - Fast and robust
 - Large capture range
 - IM model free

- An closed loop **non-perturbative method from telemetry**:
 - Based on the temporal correlation of spatial frequencies
 - IM model free (⇒ ELTs!)
 - Fast and sparse in the Fourier domain (⇒ ELTs!)
 - But:
 - relative (not absolute)
 - potentially biased by the wind

- What is next?
 - Stay tuned, **GRAVITY+ commissioning is coming!**
 - Debias the non-perturbative approach?
 - Experimental results on other WFSs (Pyramid?)



Estimation of the lateral mis-registrations of the GRAVITY+ adaptive optics system.

[Doi: 10.1051/0004-6361/202449311](https://doi.org/10.1051/0004-6361/202449311)



Contact: anthony.berdeu@obspm.fr

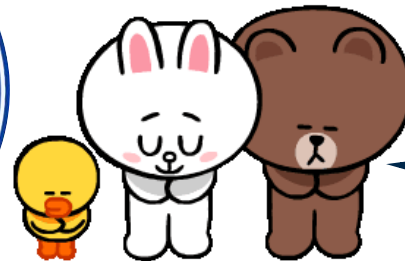

Thanks for your attention! Any question?

