



**HAL**  
open science

# The complexity of the perfect matching-cut problem

Valentin Bouquet, Christophe Picouleau

► **To cite this version:**

Valentin Bouquet, Christophe Picouleau. The complexity of the perfect matching-cut problem. Journal of Graph Theory, 2024, 10.1002/jgt.23167 . hal-04723408

**HAL Id: hal-04723408**

**<https://hal.science/hal-04723408v1>**

Submitted on 8 Oct 2024

**HAL** is a multi-disciplinary open access archive for the deposit and dissemination of scientific research documents, whether they are published or not. The documents may come from teaching and research institutions in France or abroad, or from public or private research centers.

L'archive ouverte pluridisciplinaire **HAL**, est destinée au dépôt et à la diffusion de documents scientifiques de niveau recherche, publiés ou non, émanant des établissements d'enseignement et de recherche français ou étrangers, des laboratoires publics ou privés.



Distributed under a Creative Commons Attribution - NonCommercial 4.0 International License

# The complexity of the perfect matching-cut problem

Valentin Bouquet  | Christophe Picouleau

Conservatoire National des Arts et Métiers, CEDRIC Laboratory, Paris, France

## Correspondence

Valentin Bouquet and Christophe Picouleau, Conservatoire National des Arts et Métiers, CEDRIC Laboratory, Paris, France.

Email: [valentin.bouquet@lip6.fr](mailto:valentin.bouquet@lip6.fr) and [christophe.picouleau@cnam.fr](mailto:christophe.picouleau@cnam.fr)

## Abstract

PERFECT MATCHING-CUT is the problem of deciding whether a graph has a perfect matching that contains an edge-cut. We show that this problem is NP-complete for planar graphs with maximum degree four, for planar graphs with girth five, for bipartite five-regular graphs, for graphs of diameter three, and for bipartite graphs of diameter four. We show that there exist polynomial-time algorithms for the following classes of graphs: claw-free,  $P_5$ -free, diameter two, bipartite with diameter three, and graphs with bounded treewidth.

## KEYWORDS

claw-free, edge-cut, matching, NP-complete, perfect matching, planar graph, polynomial, treewidth

## 1 | INTRODUCTION

The problem MATCHING-CUT consists of finding a matching that is an edge-cut. This problem has been extensively studied. Chvátal [6] proved that the problem is NP-complete for graphs with maximum degree four and polynomially solvable for graphs with maximum degree three. Bonsma [3] showed that this problem remains NP-complete for planar graphs with maximum degree four and for planar graphs of girth five. Bonsma et al. [4] showed that planar graphs with girth at least six have a matching-cut. They also gave polynomial algorithms for some subclasses of graphs including claw-free graphs, cographs, and graphs with fixed bounded treewidth or cliquewidth. Le and Randerath [14] showed that MATCHING-CUT is NP-complete for bipartite graphs in which the vertices of one side of the bipartition have degree three and the other vertices have degree four.

---

This is an open access article under the terms of the [Creative Commons Attribution-NonCommercial](https://creativecommons.org/licenses/by-nc/4.0/) License, which permits use, distribution and reproduction in any medium, provided the original work is properly cited and is not used for commercial purposes.

© 2024 The Author(s). *Journal of Graph Theory* published by Wiley Periodicals LLC.

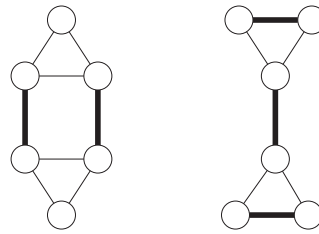

FIGURE 1 On the left a matching-cut, on the right a perfect matching-cut.

We address the problem **PERFECT MATCHING-CUT** where the matching involved in the matching-cut is contained in a perfect matching. Figure 1 shows on the left a graph having a perfect matching and a matching-cut but no perfect matching-cut (the matching-cut is outlined by the bold edges), on the right a graph having a perfect matching-cut. To our knowledge, the only reference to this problem is from Diwan [8] which he called *Disconnected 2-Factors*. The graphs he studied are cubic, so finding a disconnected 2-factor is the same as finding a perfect matching-cut. It is shown that all planar cubic bridgeless graphs have a disconnected 2-factor except  $K_4$ . Note that this is an enhancement, for planar graphs, of the famous Petersen's theorem that every cubic bridgeless graph has a perfect matching.

A variant of **PERFECT MATCHING-CUT** is studied in [9] where it is shown that it is NP-complete to recognize a graph having a partition of the vertices into  $(X, Y)$  such that the edges between  $X$  and  $Y$  form a perfect matching. In Figure 1, the graph on the right has a perfect matching-cut that is outlined by the bold edges, but it has no partition  $(X, Y)$  of the vertices such that the edges between  $X$  and  $Y$  are a perfect matching. Recently, this variant has also been studied by [10, 11].

In the same spirit of previous work on **MATCHING-CUT**, we explore the complexity of **PERFECT MATCHING-CUT**. After some observations in Section 2, we prove the following. In Section 3, **PERFECT MATCHING-CUT** is shown to be NP-complete for 5-regular bipartite graphs, for graphs with diameter three and for bipartite graphs with diameter  $d$ , for any fixed  $d \geq 4$ , and the problem is shown to be polynomial for bipartite graphs with diameter three and for graphs of diameter two. In Section 4, **PERFECT MATCHING-CUT** is shown to be NP-complete for planar graphs with degrees three or four, and for planar graphs with girth five. In Sections 5, 6, and 7, **PERFECT MATCHING-CUT** is shown to be polynomial-time solvable for the classes of  $P_5$ -free graphs (which includes cographs, split graphs, and cobipartite graphs), claw-free graphs, and graphs with bounded treewidth. Section 8 is devoted to our conclusions and some open questions.

## 2 | NOTATIONS AND PRELIMINARIES

All graphs considered in this paper are finite, undirected, simple, and loopless. For a graph  $G = (V, E)$ , let  $\delta(G)$ ,  $\Delta(G)$  denote its minimum degree, its maximum degree, respectively. The degree of a vertex  $x$  is denoted by  $d_G(x)$  or simply  $d(x)$  when the context is unambiguous. A graph is *even* when  $|V|$  is even, otherwise it is *odd*. A graph  $G$  is  $k$ -regular whenever all its vertices have the same degree  $d(x) = k$ . For  $v \in V$ ,  $N(v)$  is its neighborhood,  $N[v] = N(v) \cup \{v\}$  its closed neighborhood. For  $X \subseteq V$ , let  $N(X) = \bigcup_{x \in X} N(x)$  and  $N[X] = \bigcup_{x \in X} N[x]$ . The length of a shortest path between two vertices  $u, v$  of  $G$  is  $dist_G(u, v)$  (as usual if  $G$  is not connected, then  $dist_G(u, v) = \infty$ ). For two sets  $X, Y \subseteq V$ , the maximum length of a shortest path between a vertex of  $X$  and  $Y$  is  $dist_G(X, Y)$ . The diameter  $diam(G)$  is

$dist_G(V, V)$ . Let  $g(G)$  denote the girth of  $G$ , that is, the minimum length of a cycle. The graph  $H$  is a subgraph of  $G$ ,  $H \subset G$ , if its vertex set  $V(H) \subset V$  and its edge set  $E(H) \subset E$  is such that every  $uv \in E(H)$  is an edge of  $E$ . For  $M \subseteq E$  we write  $G - M$  the partial graph  $G = (V, E \setminus M)$ . A set  $M \subseteq E$  is a *matching* if no edges of  $M$  share a vertex. A matching  $M$  is *perfect* if every vertex is incident to one edge of  $M$ .

Given  $X \subseteq V$ , the subgraph of  $G$  induced by  $X$ , that is, the graph with the vertex set  $X$  and all the edges  $xy \in E$  with  $x \in X, y \in X$ , is denoted by  $G[X]$ . We write  $G - v = G[V \setminus \{v\}]$  and for a subset  $V' \subseteq V$  we write  $G - V' = G[V \setminus V']$ . The *contraction* of an edge  $uv \in E$  removes the vertices  $u$  and  $v$  from  $G$ , and replaces them by a new vertex denoted  $uv$  made adjacent to precisely those vertices that were adjacent to  $u$  or  $v$  in  $G$  (neither introducing self-loops nor multiple edges). This operation is denoted  $G/uv$ .

The complete graph with  $n$  vertices is  $K_n$ , also called the *clique* on  $n$  vertices. The clique  $C_3 = K_3$  is a *triangle*. Let  $K_{m,n}$  be the *bipartite clique* with  $m$  vertices on one side of the partition and  $n$  vertices on the opposite side. The *claw* is denoted  $K_{1,3}$ . Let  $C_n$  be the chordless cycle on  $n$  vertices. For a fixed graph  $H$ , the graph  $G$  is *H-free* if  $G$  has no induced subgraph isomorphic to  $H$ . For two vertex disjoint induced subgraphs  $G[A], G[B]$  of  $G$ ,  $G[A]$  is *complete* to  $G[B]$  if  $ab \in E$  for any  $a \in A, b \in B$ . Other notations or definitions of graphs that are not given here can be found in [2].

A *cut* in  $G$  is a partition  $V = X \cup (V \setminus X)$  with  $X, V \setminus X \neq \emptyset$ . The set of all edges in  $G$  having an endvertex in  $X$  and the other endvertex in  $V \setminus X$ , also written  $E(X, V \setminus X)$ , is called the *edge-cut* of the cut. When the context is unambiguous we can use the term cut for edge-cut. A *bridge* is an edge-cut with exactly one edge. Note that when  $G$  is connected every edge-cut  $C = E(X, V \setminus X)$  is such that  $G - C$  is disconnected; we say that  $C$  disconnects  $G$ . A *matching-cut* is an edge-cut that is a matching. A *perfect matching-cut* is a perfect matching that contains a matching-cut. When a connected graph or subgraph cannot be disconnected by a matching it is called *immune*, when it cannot be disconnected by a perfect matching it is called *perfectly immune*.

The decision problem associated with PERFECT MATCHING-CUT is defined as:

PERFECT MATCHING-CUT

*Instance:* a connected graph  $G = (V, E)$ .

*Question:* is there  $M \subset E$  such that  $M$  is a perfect matching and  $G - M$  is not connected?

Note that PERFECT MATCHING-CUT is in NP.

Here we give some observations.

**Fact 2.1.** For every  $2 \leq i < j$ ,  $K_j$  and  $K_{i,j}$  are immune.

**Fact 2.2.** Let  $G = (V \cup \{u\}, E)$  be a graph where  $G[V]$  is immune. If  $u$  has at least two neighbors in  $V$ , then  $G$  is also immune.

**Fact 2.3.** Assume that  $G$  has a perfect matching-cut  $M$  with  $E(X, V \setminus X) \subset M$  and let  $H$  be an immune subgraph of  $G$ . Then either  $V(H) \subset X$  or  $V(H) \subset V \setminus X$ .

**Fact 2.4.** Assume that  $G$  has a perfect matching-cut  $M$  with  $E(X, V \setminus X) \subset M$ . If  $v$  has two neighbors in  $X$ , then  $v \in X$ .

*Proof.* Let  $M$  be a perfect matching. There is a unique vertex  $u$  such that  $uv \in M$ . So in  $G - M$ ,  $v$  has a neighbor in  $X$ . Hence  $v \in X$ .  $\square$

**Fact 2.5.** If  $M$  is a perfect matching that contains a bridge, then  $M$  is a perfect matching-cut.

**Fact 2.6.** If a graph  $G$  with  $\delta(G) = 1$  has a perfect matching, then  $G$  has a perfect matching-cut.

### 3 | BIPARTITE GRAPHS AND BOUNDED DIAMETER

We give our results for bipartite graphs, regular graphs, and for graphs with fixed diameter. First, we show the cases where PERFECT MATCHING-CUT remains NP-complete. Second, some positive cases where PERFECT MATCHING-CUT can be solved in polynomial-time.

#### 3.1 | NP-complete classes

**Theorem 3.1.** *PERFECT MATCHING-CUT is NP-complete for 5-regular connected graphs.*

*Proof.* By Le and Randerath [14] we know the following: deciding if a bipartite graph  $G = (V = S \cup T, E)$ , such that all the vertices of  $T$  have degree three and all the vertices of  $S$  have degree four, has a matching-cut is NP-complete.

From  $G$  we build (in polynomial-time) a connected graph  $G' = (V', E')$  as follows. We take two copies  $G_1 = (V_1 = S_1 \cup T_1, E_1)$ ,  $G_2 = (V_2 = S_2 \cup T_2, E_2)$  of  $G$ . For each  $v \in T$ , let  $v_1 \in T_1, v_2 \in T_2$ , be its two copies in  $G_1, G_2$ , respectively. We link  $v_1$  to  $v_2$  with the graph depicted in Figure 2. Let us call  $G_g$  this graph. For each  $v \in S$ , let  $v_1 \in S_1, v_2 \in S_2$  be its two copies in  $G_1, G_2$ , respectively. We add the edge  $v_1 v_2$ . One can see that  $G'$  is bipartite and 5-regular.

The graph  $G_t$  induced by the 10 vertices situated on the top of  $G_g$  is the graph  $K_{5,5} - M$ , the balanced bipartite complete graph minus a perfect matching, that is, the 4-regular bipartite graph on 10 vertices. It contains  $K_{2,3}$  as an induced subgraph which is immune from

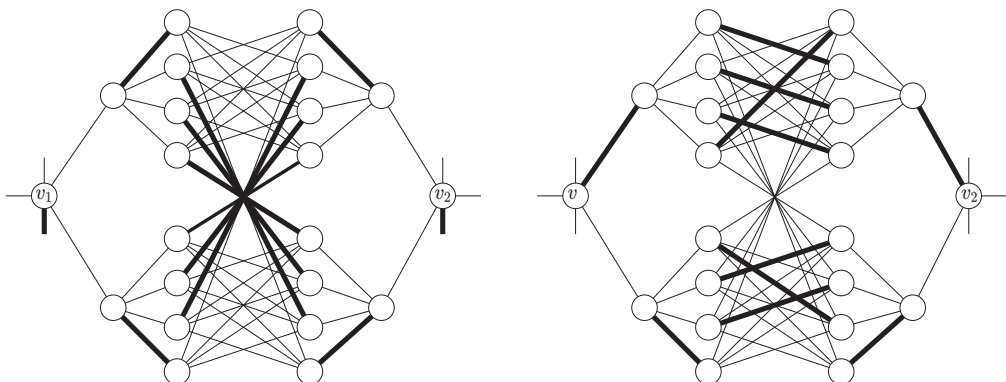

FIGURE 2 On the left  $v$  is covered by  $M$ , on the right  $v$  is not covered by  $M$ .

Fact 2.1. Then from Fact 2.2,  $G_t$  is immune. Since  $G_b$ , the graph induced by the 10 vertices situated on the bottom of  $G_g$ , is isomorphic to  $G_t$ , it follows that  $G_b$  is immune. We will show that  $G_g$  is perfectly immune. In any perfect matching  $M_g$  of  $G_g$  one of the two incident edges of  $v_1$  is not in  $M_g$ . We suppose that this edge is, as in the right of Figure 2, that is, the one connecting  $v_1$  to  $G_b$ . Since  $G_b$  is immune there is a path from  $v_1$  to any vertex of  $G_b$  in  $G_b - M_g$ . Among the four independent vertices situated on the left of  $G_b$  exactly one is covered with the edge of  $M_g$  that covers the neighbor of  $v_1$ . Thus there exists an edge between this vertex and a vertex of  $G_t$ . It follows that  $G_g$  is perfectly immune.

Given a matching-cut  $M$  of  $G$ , we build a perfect matching-cut  $M'$  as follows. For each  $uv \in M$ ,  $u \in S$ ,  $v \in T$ , we take  $u_1v_1, u_2v_2$  and the edges represented by the bold lines on the left of Figure 2. For each vertex  $w$  which is not covered by  $M$ : if  $w \in T$ , then we take the edges represented by the bold lines on the right of Figure 2; if  $w \in S$ , then we take the edge  $w_1w_2$ . Hence  $M'$  is a perfect matching of  $G'$ . There are two vertices  $u, v$  in  $G - M$  with no path between them, so there is no path linking  $u_i$  with  $v_j$ ,  $i, j \in \{1, 2\}$  in  $G' - M'$ . So  $M'$  is a perfect matching-cut of  $G'$ .

Reciprocally, let  $M'$  be a perfect matching-cut of  $G'$ . Let  $M'_i = M' \cap E_i$ ,  $i \in \{1, 2\}$ , and  $M'_g = M' \setminus (M'_1 \cup M'_2)$ . We show that  $G_1 - M'_1$  or  $G_2 - M'_2$  is disconnected. For contradiction, we assume that  $G_1 - M'_1$  and  $G_2 - M'_2$  are connected. Therefore  $G' - M'_g$  is disconnected. Since the subgraph depicted in Figure 2 is perfectly immune each  $G_g - M'_g$  is connected. Thus there is a path in  $G' - M'_g$  from any vertex  $v_1 \in T_1$  to any vertex  $v_2 \in T_2$ . Yet  $G_t - M'$  is connected, and so there is a path in  $G' - M'_g$  from any vertex of  $v_1 \in V_1$  to any vertex of  $v_2 \in V_2$ , a contradiction. So  $M'_1$  or  $M'_2$  is a matching-cut of  $G_1$  or  $G_2$  which are copies of  $G$ .  $\square$

**Theorem 3.2.** *PERFECT MATCHING-CUT is NP-complete for graphs of diameter 3.*

*Proof.* By Le and Le [13], we know that deciding if a graph  $G = (V, E)$  with  $\text{diam}(G) = 3$  has a matching-cut is NP-complete. Their proof inspired ours.

Given  $G = (V, E)$ , we build (in polynomial-time) a connected graph  $G' = (V', E')$  as follows. We take two copies  $G_1 = (V_1, E_1)$ ,  $G_2 = (V_2, E_2)$  of  $G$ . We denote  $V = \{v_1, v_2, \dots, v_n\}$ ,  $V_1 = \{v_1^1, v_2^1, \dots, v_n^1\}$ ,  $V_2 = \{v_1^2, v_2^2, \dots, v_n^2\}$ . For each  $1 \leq i \leq n$ , let  $K_{v_i^1}$  be a complete graph of  $n$  vertices. We add an edge between  $v_i^1$  and every vertex of  $K_{v_i^1}$ . So  $K_{v_i^1} \cup \{v_i^1\}$  is a clique of size  $n + 1$ . We say that  $K_{v_i^1}$  is the clique associated with  $v_i^1$ . Let  $K^1 = \bigcup_{i=1, \dots, n} V(K_{v_i^1})$  be the set of vertices of the associated cliques of vertices of  $V_1$ . For each pair of cliques  $K_{v_i^1}, K_{v_j^1}$ ,  $i < j$ , we add exactly one edge  $q_i q_j$ ,  $q_i \in K_{v_i^1}$ ,  $q_j \in K_{v_j^1}$ , in such a way that  $q_i, q_j$  has exactly one neighbor in  $K^1 \setminus K_{v_i^1}, K^1 \setminus K_{v_j^1}$ , respectively. So  $E(K_{v_i^1}, K^1 \setminus K_{v_i^1})$  is a matching covering all vertices, except one, of  $K_{v_i^1}$ . We do the same for the vertices  $v_i^2$  of  $V_2$ . For each  $1 \leq i \leq n$ , we make  $K_{v_i^1} \cup \{v_i^1\}$  complete to  $K_{v_i^2}$ , and  $K_{v_i^2} \cup \{v_i^2\}$  complete to  $K_{v_i^1}$ . Note that  $v_i^1 v_i^2$  is not an edge. Also,  $K_{v_i^1, v_i^2} = K_{v_i^1} \cup K_{v_i^2}$  is a clique with  $2n$  vertices, and  $K_{v_i^1, v_i^2} \cup \{v_i^1\}, K_{v_i^1, v_i^2} \cup \{v_i^2\}$  are two cliques with  $2n + 1$  vertices. Therefore  $K_{v_i^1, v_i^2} \cup \{v_i^1, v_i^2\}$  is immune. We are finished with the construction of  $G'$ . Note that  $V_1, V_2, K^1, K^2$  is a partition of the vertices of  $G'$ .

We show that  $\text{diam}(G') = 3$ . For every  $i, j$ , since there is an edge between  $K_{v_i^1}$  and  $K_{v_j^1}$ ;  $K_{v_i^2}$  and  $K_{v_j^2}$ , it follows that there is a path of length at most two between any vertex of  $K_{v_i^1, v_i^2}$  to a vertex of  $K_{v_j^1, v_j^2}$ . Therefore for any pair  $q, q' \in K^1 \cup K^2$ ,  $\text{dist}_{G'}(q, q') \leq 3$ . For the same

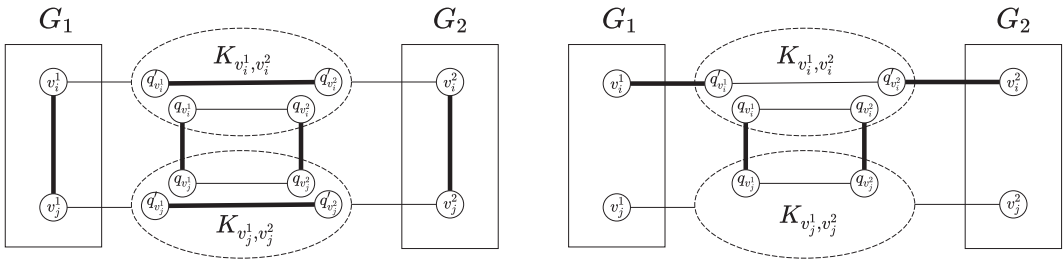

FIGURE 3 On the left  $v_i, v_j$  are covered by  $M$ , on the right  $v_i$  is not covered by  $M$ .

reason and since every vertex  $v_i^j \in V_j$  is complete to  $K_{v_i^1, v_i^2}$ , it follows that: for any pair  $v \in V_1 \cup V_2, q \in K^1 \cup K^2, dist_{G'}(q, v) \leq 3$ ; for any pair  $v, v' \in V_1 \cup V_2, dist_{G'}(v, v') \leq 3$ . So  $diam(G') = 3$ .

Given a matching-cut  $M$  of  $G$ , we build a perfect matching-cut  $M'$  of  $G'$  as follows. For each pair  $v_i, v_j \in V, i < j$ , let  $v_i^1, v_j^1 \in V_1$  and  $v_i^2, v_j^2 \in V_2$  be their corresponding vertices in  $G'$ . We take  $q_{v_i^1} q_{v_j^1}$  and  $q_{v_i^2} q_{v_j^2}$  in  $M'$ , where  $q_{v_i^1} \in K_{v_i^1, v_i^2}, q_{v_i^2} \in K_{v_i^1, v_i^2}, q_{v_j^1} \in K_{v_j^1, v_j^2}$  and  $q_{v_j^2} \in K_{v_j^1, v_j^2}$  (see Figure 3). Recall that for each pair  $K_{v_i^1, v_i^2}, K_{v_j^1, v_j^2}, i \neq j$ , there are exactly two edges between the two cliques, and these edges are in  $M'$ . Therefore  $K_{v_i^1, v_i^2}, K_{v_j^1, v_j^2}$  are two connected components in  $G'[K^1 \cup K^2] - M'$ . For each  $v_i v_j \in M$ , we take  $v_i^1 v_j^1, v_i^2 v_j^2$  in  $M'$ . We show that  $G' - M'$  is disconnected. Let  $(X, Y)$  be a partition of  $G$  induced by the matching-cut  $M$ . Let  $X_i, Y_i$  be the associated vertices of  $X, Y$  in  $G_i$ , respectively. Note that there is no path from  $X_i$  to  $Y_i$  in  $G_i - M', i = 1, 2$ . So, since for every  $v_i^1 \in X_1, v_i^2 \in X_2, v_j^1 \in Y_1, v_j^2 \in Y_2$ , there is no path from  $K_{v_i^1, v_i^2}$  to  $K_{v_j^1, v_j^2}$  in  $G'[K^1 \cup K^2] - M'$ , it follows that there is no path from  $X_1 \cup X_2$  to  $Y_1 \cup Y_2$  in  $G' - M'$ . Therefore  $G' - M'$  is disconnected. Since  $M'$  is a matching-cut of  $G'$ , it remains to add some edges so that every vertex of  $G'$  will be covered by  $M'$ . In  $V_1, V_2$ , it remains to cover the vertices  $v_i^1, v_i^2$  where  $v_i \in V$  is not covered by  $M$  in  $G$ . In  $K^1, K^2$ , for each  $K_{v_i^1, v_i^2}$  it remains to cover only two vertices. Let  $v_i \in V$  and  $q'_{v_i^1}, q'_{v_i^2} \in K_{v_i^1, v_i^2}$  be the two vertices not yet covered by  $M'$ . If  $v_i$  is not covered by  $M$  in  $G$ , then we take  $q'_{v_i^1} v_i^1, q'_{v_i^2} v_i^2$  in  $M'$  (see Figure 3 on the right). Otherwise,  $v_i$  is covered by  $M$  in  $G$ , and we take  $q'_{v_i^1} q'_{v_i^2}$  in  $M'$  (see Figure 3 on the left). So  $M'$  is a perfect matching-cut.

Reciprocally, let  $M'$  be a perfect matching-cut of  $G'$ . Let  $M'_i = M' \cap E_i, i \in \{1, 2\}$ , and  $M'_K = M' \setminus (M'_1 \cup M'_2)$ . We show that  $G_1 - M'_1$  or  $G_2 - M'_2$  is disconnected. For contradiction, we assume that  $G_1 - M'_1$  and  $G_2 - M'_2$  are connected. Therefore  $G' - M'_K$  is disconnected. Yet, since for each pair  $v_i^1, v_i^2$ , the clique  $K_{v_i^1, v_i^2} \cup \{v_i^1, v_i^2\}$  is immune, it follows that there is a path in  $G' - M'_K$  from  $v_i^1 \in V_1$  to  $v_j^2 \in V_2$ , for  $1 \leq i \leq j \leq n$ , a contradiction. So  $M'_1$  or  $M'_2$  is a matching-cut of  $G_1$  or  $G_2$  which are copies of  $G$ .  $\square$

**Theorem 3.3.** PERFECT MATCHING-CUT is NP-complete for bipartite graphs of diameter 4.

*Proof.* In Le and Le [13] it is shown that deciding whether a bipartite graph  $G$  with  $diam(G) = 4$  has a matching-cut is NP-complete. Their proof inspired ours.

Given a bipartite graph  $G = (V = A \cup B, E)$  with  $diam(G) = 4$ , we build (in polynomial-time) a connected graph  $G' = (V', E')$  as follows. We take two copies  $G_1 = (V_1 = A_1 \cup B_1, E_1), G_2 = (V_2 = A_2 \cup B_2, E_2)$  of  $G$ . We denote  $V = \{v_1, v_2, \dots, v_n\}, V_1 = \{v_1^1, v_2^1, \dots, v_n^1\}, V_2 = \{v_1^2, v_2^2, \dots, v_n^2\}$ . For each  $1 \leq i \leq n$ , let  $Q_{v_i^1}$  be an independent set of  $n$



vertices. We add an edge between  $v_i^1$  and every vertex of  $Q_{v_i^1}$ . So  $Q_{v_i^1} \cup \{v_i^1\}$  is a complete bipartite graph of order  $n + 1$ . We say that  $Q_{v_i^1}$  is the associated independent set of  $v_i^1$ . We do the same for the vertices  $v_i^2$  of  $G_2$ . Then, for each pair  $v_i^1 \in V_1, v_i^2 \in V_2$  we make  $Q_{v_i^1}$  complete to  $Q_{v_i^2}$ . So  $Q_{v_i^1} \cup Q_{v_i^2}$  is isomorphic to  $K_{n,n}$ . Let us denote  $Q_{v_i^1, v_i^2} = Q_{v_i^1} \cup Q_{v_i^2}$ ,  $Q_{A_k} = \bigcup_{v \in A_k} Q_v$ ,  $Q_{B_k} = \bigcup_{v \in B_k} Q_v$ ,  $Q_k = Q_{A_k} \cup Q_{B_k}$ ,  $k = 1, 2$ , and  $Q = Q_1 \cup Q_2$ . Note that  $Q_{v_i^1, v_i^2} \cup \{v_i^1, v_i^2\}$  is immune.

For each pair  $v_i, v_j \in A, i < j$ , we add exactly one edge between  $Q_{v_i^1}$  and  $Q_{v_j^2}$  and exactly one edge between  $Q_{v_i^2}$  and  $Q_{v_j^1}$ . We proceed similarly with the pairs  $v_i, v_j \in B, i < j$ . For each pair  $v_i \in A, v_j \in B$ , we add exactly one edge between  $Q_{v_i^1}$  and  $Q_{v_j^1}$  and exactly one edge between  $Q_{v_i^2}$  and  $Q_{v_j^2}$ . We perform all the above operations such that every vertex  $q \in Q_{v_i^1, v_i^2}$  has at most one neighbor in  $Q \setminus Q_{v_i^1, v_i^2}$ . Therefore  $E(Q_{v_i^1, v_i^2}, Q \setminus Q_{v_i^1, v_i^2})$  is a matching of  $G'$ . Note that this is possible because  $|Q_{v_i^1, v_i^2}| = 2n$ . Thus for each  $i = 1, \dots, n$ , there are exactly two vertices of  $Q_{v_i^1, v_i^2}$  that are not covered by one edge of the matching  $E(Q_{v_i^1, v_i^2}, Q \setminus Q_{v_i^1, v_i^2})$ . Now we are finished with the construction of  $G'$ .

We observe that  $A_1 \cup Q_{B_1} \cup Q_{A_2} \cup B_2$  and  $B_1 \cup Q_{A_1} \cup Q_{B_2} \cup A_2$  are two disjoint independent sets that form a partition of  $V'$  the vertex set of  $G'$ . So  $G'$  is bipartite.

We show that  $diam(G') = 4$ . For each pair  $v_i, v_j \in A$  or  $v_i, v_j \in B$ , there is an edge between  $Q_{v_i^1}$  and  $Q_{v_j^2}$ ;  $Q_{v_i^2}$  and  $Q_{v_j^1}$ . For each pair  $v_i \in A, v_j \in B$ , there is an edge between  $Q_{v_i^1}$  and  $Q_{v_j^1}$ ;  $Q_{v_i^2}$  and  $Q_{v_j^2}$ . So, for every pair  $v_i, v_j \in V$ , since  $Q_{v_i^1, v_i^2}$  is a complete bipartite subgraph, it follows that there is a path of length at most two from any vertex of  $Q_{v_i^1, v_i^2}$  to a vertex of  $Q_{v_j^1, v_j^2}$ . Therefore, for any pair  $q, q' \in Q, dist_{G'}(q, q') \leq 4$ . For the same reason, since every vertex  $v_i^j \in V_j$  is complete to  $Q_{v_i^j}$ , it follows that for any pair  $v_i^j \in V_j, q \in Q, dist_{G'}(q, v_i^j) \leq 4$ . With the same argument, for every pair  $v_i^1, v_j^2, dist_{G'}(v_i^1, v_j^2) \leq 4$ . Since  $diam(G) = 4$ , it follows that for any pair  $v, v' \in V_1$  or  $v, v' \in V_2, dist_{G'}(v, v') = 4$ . So  $diam(G') = 4$ .

Given a matching-cut  $M$  of  $G$ , we build a perfect matching-cut  $M'$  of  $G'$  as follows. For each  $Q_{v_i^1, v_i^2}$ , we add all edges of  $E(Q_{v_i^1, v_i^2}, Q \setminus Q_{v_i^1, v_i^2})$  (which is a matching) to  $M'$ . Recall that for each pair  $Q_{v_i^1, v_i^2}, Q_{v_j^1, v_j^2}, i < j$ , there are exactly two edges between the two sets, and these edges are in  $M'$  (see Figures 4 and 5). Therefore  $Q_{v_i^1, v_i^2}, Q_{v_j^1, v_j^2}$  are two connected components in  $G'[Q] - M'$ . For each  $v_i v_j \in M$ , we take  $v_i^1 v_j^1, v_i^2 v_j^2$  in  $M'$ . We show that  $G' - M'$  is disconnected. Let  $(X, Y)$  be a partition of  $G$  induced by the matching-cut  $M$ . Let  $X_i, Y_i$  be the associated vertices of  $X, Y$  in  $G_i$ , respectively. Note that there is no path from  $X_i$  to  $Y_i$  in

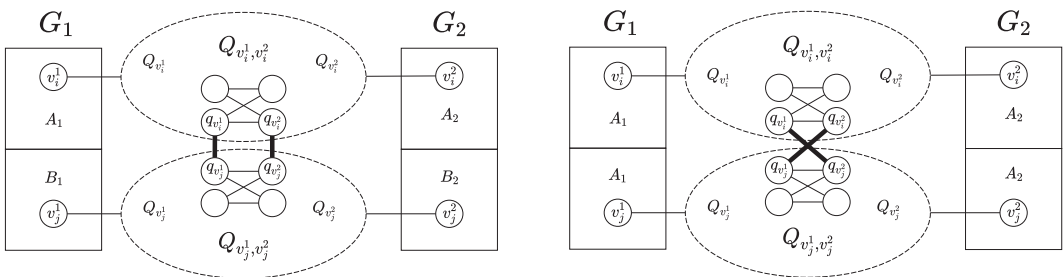

FIGURE 4 On the left,  $v_i^1 \in A_1, v_i^2 \in A_2, v_j^1 \in B_1, v_j^2 \in B_2$  and  $q_{v_i^1} q_{v_j^1}, q_{v_i^2} q_{v_j^2}$  are in the perfect matching-cut of  $G'$ . On the right,  $v_i^1, v_j^1 \in A_1$  (resp.,  $v_i^1, v_j^1 \in B_1$ ),  $v_i^2, v_j^2 \in A_2$  (resp.,  $v_i^2, v_j^2 \in B_2$ ) and  $q_{v_i^1} q_{v_j^2}, q_{v_i^2} q_{v_j^1}$  are in the perfect matching-cut of  $G'$ .



$G_i - M', i = 1, 2$ . So, since for every  $v_i^1 \in X_1, v_i^2 \in X_2, v_j^1 \in Y_1, v_j^2 \in Y_2, i < j$ , there is no path from  $Q_{v_i^1, v_i^2}$  to  $Q_{v_j^1, v_j^2}$  in  $G'[Q] - M'$ , it follows that there is no path from  $X_1 \cup X_2$  to  $Y_1 \cup Y_2$  in  $G' - M'$ . Therefore  $G' - M'$  is disconnected. Since  $M'$  is a matching-cut of  $G'$ , it remains to add some edges so that every vertex of  $G'$  will be covered by  $M'$ . In  $V_1 \cup V_2$ , it remains to cover the vertices  $v_i^1, v_i^2$  where  $v_i \in V$  is not covered by  $M$  in  $G$ . In  $Q$ , it remains to cover exactly two vertices for each  $Q_{v_i^1, v_i^2}$ . Let  $v_i \in V$ , and let  $q'_{v_i^1}, q'_{v_i^2} \in Q_{v_i^1, v_i^2}$  be the two vertices not yet covered by  $M'$ . If  $v_i$  is not covered by  $M$  in  $G$ , then we take  $q'_{v_i^1}v_i^1, q'_{v_i^2}v_i^2$  in  $M'$  (see Figure 5 on the right). Otherwise,  $v_i$  is covered by  $M$  in  $G$ , and we take  $q'_{v_i^1}q'_{v_i^2}$  in  $M'$  (see Figure 5 on the left). So  $M'$  is a perfect matching-cut.

Reciprocally, let  $M'$  be a perfect matching-cut of  $G'$ . Let  $M'_i = M' \cap E_i, i \in \{1, 2\}$ , and  $M'_Q = M' \setminus (M'_1 \cup M'_2)$ . We show that  $G_1 - M'_1$  or  $G_2 - M'_2$  is disconnected. For contradiction, we assume that  $G_1 - M'_1$  and  $G_2 - M'_2$  are connected. Therefore  $G' - M'_Q$  is disconnected. Yet, since for each pair  $v_i^1, v_i^2$ , the set  $Q_{v_i^1, v_i^2} \cup \{v_i^1, v_i^2\}$  is immune, it follows that there is a path in  $G' - M'_Q$  from  $v_i^1 \in V_1$  to  $v_j^2 \in V_2$ , for  $1 \leq i < j \leq n$ , a contradiction. So  $M'_1$  or  $M'_2$  is a matching-cut of  $G_1$  or  $G_2$  which are copies of  $G$ .  $\square$

Using the preceding arguments but adding the bipartite graph  $H$  of Figure 6 such that  $u_i, u'_i \in V(H)$  are complete to  $Q_{w_i^1}$  and  $v_1, v'_1 \in V(H)$  are complete to  $Q_{w_i^2}$  where  $w_i^1, w_i^2$  correspond to the two copies of a vertex  $w_i$  of  $G$ , we obtain a bipartite graph  $G'$  with  $diam(G') = d, d \geq 4$ . Note that  $G[V(H) \cup Q_{w_i^1} \cup Q_{w_i^2}]$  is immune and that  $H$  has a perfect matching  $u_1v_1, u'_1v'_1, \dots, u_{d-2}v_{d-2}, u'_{d-2}v'_{d-2}$ . The following theorem follows.

**Theorem 3.4.** For every fixed  $d \geq 4$ , PERFECT MATCHING-CUT is NP-complete for bipartite graphs of diameter  $d$ .

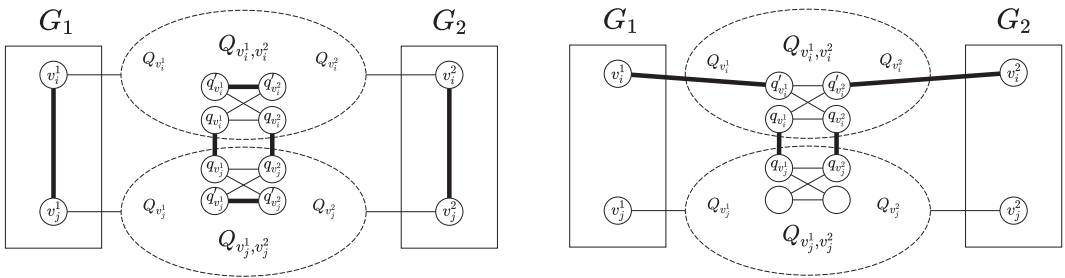

FIGURE 5 On the left,  $v_i, v_j$  are covered by the matching-cut of  $G$ , and so we take  $v_i^1v_i^1, v_i^2v_i^2$  in the perfect matching-cut of  $G'$ . On the right,  $v_i$  is not covered by the matching-cut of  $G$ , and so we take  $v_i^1q'_{v_i^1}, v_i^2q'_{v_i^2}$  in the perfect matching-cut of  $G'$ .

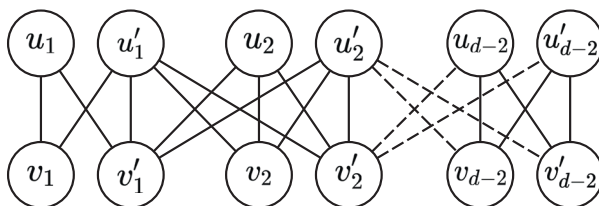

FIGURE 6 The bipartite chain composed of  $K_{3,3}$ .

### 3.2 | Polynomial classes

Whereas PERFECT MATCHING-CUT is NP-complete for bipartite graphs with diameter four, here we prove that PERFECT MATCHING-CUT is polynomial for bipartite graphs with diameter three. Afterward, we prove that PERFECT MATCHING-CUT is polynomial for the graphs with diameter two.

For our proof we use the following characterization given in [13] (see Fact 2).

**Fact 3.5.** Let  $G = (V_1 \cup V_2, E)$  be a bipartite graph. Then  $\text{diam}(G) \leq 3$  if and only if  $N(a) \cap N(b) \neq \emptyset$  for any pair of distinct vertices  $a, b$  in the same side of the bipartition.

We use the following observations. Let  $G = (V_1 \cup V_2, E)$  be a bipartite graph and two subsets of vertices  $X, Y \subseteq V$ . We say that  $(X, Y)$  is extensible to a (perfect) matching-cut  $(X', Y')$  if  $E(X', Y')$  is a matching-cut (i.e., contained in a perfect matching), and  $X \subseteq X', Y \subseteq Y'$ .

**Fact 3.6.** If  $E(X, Y)$  is not a matching or  $X \cap Y \neq \emptyset$ , then  $(X, Y)$  is not extensible to a (perfect) matching-cut.

**Fact 3.7.** Let  $uv \in E(X, Y)$  with  $u \in X, v \in Y$ . If  $(X, Y)$  is extensible to a (perfect) matching-cut  $(X', Y')$ , then  $N(u) \setminus \{v\} \subseteq X'$  and  $N(v) \setminus \{u\} \subseteq Y'$ .

**Fact 3.8.** If a vertex  $v$  has two neighbors in  $X$ , respectively, in  $Y$ , then for every extensible (perfect) matching-cut  $(X', Y')$ ,  $v \in X'$ , respectively,  $v \in Y'$ .

**Fact 3.9.** If a vertex  $v$  has neighbors  $x \in X$  and  $y \in Y$ , such that  $x, y$  are covered by  $E(X, Y)$ , then  $(X, Y)$  is not extensible to a (perfect) matching-cut.

We are ready to show the following.

**Theorem 3.10.** PERFECT MATCHING-CUT is polynomial-time solvable for bipartite graphs with diameter at most 3.

*Proof.* Let  $G = (V_1 \cup V_2, E)$  be a bipartite graph with  $\text{diam}(G) \leq 3$ . We can assume that  $G$  has a perfect matching, and therefore  $|V_1| = |V_2|$ . If  $uv$  is a bridge, then we can check if  $G \setminus \{u, v\}$  has a perfect matching  $M$ . So either  $M \cup \{uv\}$  is a perfect matching-cut or there is no perfect matching containing the cut  $uv$ . Now there is no bridge that is extensible to a perfect matching-cut. Therefore  $\delta(G) \geq 2$ , and if there is  $E(X, Y)$  a matching-cut of  $G$  that is extensible to a perfect matching-cut, then  $|X|, |Y| \geq 2$ . Moreover, since  $G$  is bipartite, it follows that  $X \not\subseteq V_1, Y \not\subseteq V_2$ . Therefore there are two edges  $ab, cd$  of  $G$  such that  $a, c \in X, b, d \in Y$ , and  $a, d \in V_1, b, c \in V_2$ . So for every pair  $ab, cd \in E$  such that  $a, d \in V_1, b, c \in V_2$ , we either try to derive a matching-cut from  $(X = \{a, c\}, Y = \{b, d\})$ , or we show that  $(X, Y)$  is not extensible to a matching-cut. Last, we either derive a perfect matching-cut from it, or we show  $(X, Y)$  is not extensible to a perfect matching-cut.

Let  $ab, cd \in E$  such that  $a, d \in V_1, b, c \in V_2$ . We set  $X = \{a, c\}$  and  $Y = \{b, d\}$ . At any point, the algorithm stops if  $E(X, Y)$  is not a matching or that  $X \cap Y \neq \emptyset$ , because of Fact 3.6. Since  $G$  is bipartite, it follows that  $N(a) \cap N(b) = N(a) \cap N(c) = N(b) \cap N(d) = N(c) \cap N(d) = \emptyset$ . From Fact 3.9, since  $ab, cd \in E(X, Y)$ , it follows

that if  $N(a) \cap N(d) \setminus \{b, c\} \neq \emptyset$  or  $N(b) \cap N(c) \setminus \{a, d\} \neq \emptyset$ , then  $E(X, Y)$  is not extensible to a matching-cut. So we stop. Now  $N(a) \cap N(d) \setminus \{b, c\} = \emptyset$  and  $N(b) \cap N(c) \setminus \{a, d\} = \emptyset$ .

We define the following sets of vertices:

- $A = N(a) \setminus \{b, c\}$ ,  $B = N(b) \setminus \{a, d\}$ ,  $C = N(c) \setminus \{a, d\}$ ,  $D = N(d) \setminus \{b, c\}$ ;
- $S = \{v \in V_1 \mid v \notin N(b) \cup N(c), N(v) \cap A \neq \emptyset, N(v) \cap D \neq \emptyset\}$ ;
- $T = \{v \in V_2 \mid v \notin N(a) \cup N(d), N(v) \cap B \neq \emptyset, N(v) \cap C \neq \emptyset\}$ .

We show that  $A, B, C, D, S, T, \{a, b, c, d\}$  is a partition of  $V_1 \cup V_2$ . The subsets are pairwise disjoint. By contradiction, we assume that there exists  $v \in V_1$  that is not in one of the previous subsets. By Fact 3.5, it follows that  $N(v) \cap N(a) \neq \emptyset$  and  $N(v) \cap N(d) \neq \emptyset$ . Since  $N(a) \subseteq A \cup \{b, c\}$ ,  $N(d) \subseteq D \cup \{b, c\}$ , it follows that either  $v \in B \cup C$  or  $v \in S$ , a contradiction. The case  $v \in V_2$  is symmetric.

Since  $ab, cd \in E(X, Y)$ , it follows from Fact 3.7 that we must set  $X \leftarrow X \cup A \cup C$ ,  $Y \leftarrow Y \cup B \cup D$ . If  $E(X, Y)$  is not a matching, then we stop. Now  $E(X, Y)$  is a matching. For every edge  $xy \in E(X, Y)$  with  $x \in X, y \in Y$ ,  $N(x) \setminus \{y\}$  and  $N(y) \setminus \{x\}$  must be added to  $X, Y$ , respectively, because of Fact 3.7. Notice that these neighbors are in  $S \cup T$ . So we set  $X \leftarrow X \cup (N(x) \setminus \{y\})$  and  $Y \leftarrow Y \cup (N(y) \setminus \{x\})$ . Then from Fact 3.8, if there is a vertex  $v \in S \cup T$  that has at least two neighbors in  $X$  (resp.,  $Y$ ), then we set  $X \leftarrow X \cup \{v\}$  (resp.,  $Y \leftarrow Y \cup \{v\}$ ). Afterward, if  $X \cap Y \neq \emptyset$  or if  $E(X, Y)$  is not a matching, then we stop. Note that if there are vertices in  $V \setminus (X \cup Y)$ , then those vertices belong to  $S \cup T$ . Also, for each vertex  $x \in A \cup C$  (resp.,  $y \in B \cup D$ ) that is covered by  $E(X, Y)$ , we have  $N(x) \cap (S \cup T) \subseteq X$  (resp.,  $N(y) \cap (S \cup T) \subseteq Y$ ).

Let  $S' = \{v \in S \mid v \notin X \cup Y\}$  and  $T' = \{v \in T \mid v \notin X \cup Y\}$ . From the above operations and since  $\delta(G) \geq 2$ , it follows that each vertex of  $S'$  (resp.,  $T'$ ) has exactly one neighbor in  $A$  (resp.,  $B$ ) and exactly one neighbor in  $D$  (resp.,  $C$ ). Also those two neighbors are not covered by  $E(X, Y)$ . Let  $A' = \{v_a \in A \mid vv_a \in E, v \in S'\}$ ,  $D' = \{v_d \in D \mid vv_d \in E, v \in S'\}$ ,  $B' = \{v_b \in B \mid vv_b \in E, v \in T'\}$ ,  $C' = \{v_c \in C \mid vv_c \in E, v \in T'\}$ .

Let  $v_a \in A', v_d \in D'$ . From Fact 3.5  $N(v_a) \cap N(v_d) \neq \emptyset$ . Recall that  $N(v_a) \cap Y = \emptyset$  (resp.,  $N(v_d) \cap X = \emptyset$ ), and thus  $N(v_a) \cap B = \emptyset$  (resp.,  $N(v_d) \cap C = \emptyset$ ). Therefore  $N(v_a) \cap N(v_d) \subseteq S'$ . By symmetry, for every pair  $v_b \in B', v_c \in C'$ , we have  $N(v_b) \cap N(v_c) \neq \emptyset$  and  $N(v_b) \cap N(v_c) \subseteq T'$ .

In the following, we focus solely on  $S'$  (the arguments are the same for  $T'$ ). Suppose that  $(X, Y)$  is extensible to a matching-cut  $(X', Y')$ . Recall that  $A' \subseteq X$  and  $D' \subseteq Y$ . Since each vertex of  $v \in S'$  has a neighbor in  $X$  and  $Y$ , it follows that either  $v \in X'$  or  $v \in Y'$ . Therefore there is either  $vv_a \in E(X', Y')$  or  $vv_d \in E(X', Y')$  where  $v_a \in N(v) \cap A'$  and  $v_d \in N(v) \cap D'$ . So for every  $s \in S'$ , we could test if one of  $(X \cup \{s\}, Y)$  or  $(X, Y \cup \{v\})$  is extensible to a matching-cut of  $G$ . Yet, we show that we do not need to test all configurations. For that, we show that it suffices to consider the matching-cuts of  $G' = G[A' \cup D' \cup S']$ . Note that  $G'$  is connected, since from Fact 3.5, for every  $v_a \in A', v_d \in D'$ , we have  $N(v_a) \cap N(v_d) \cap S' \neq \emptyset$ . Since there is no path from  $X'$  to  $Y'$  in  $G - E(X', Y')$ , it follows that there is no path from  $A'$  to  $D'$  in  $G' - E(X', Y')$ . Let  $M'$  be the edges of  $E(X', Y')$  in  $G'$ . Thus  $M'$  is a matching-cut that disconnects  $A'$  from  $D'$ . Note that for each vertex  $s \in S'$ : if  $sa \in M'$  with  $a \in A'$ , then  $s \in Y'$ ; else  $sd \in M'$  with  $d \in D'$ , then  $s \in X'$ . So by testing every matching-cut  $M'$  of  $G'$  that disconnects  $A'$  from

$D'$ , we can conclude if  $(X, Y)$  is indeed extensible to a matching-cut of  $G$ . We will prove that  $G'$  has at most  $|V|$  matching-cuts.

First, we give some upper bounds on the number of vertices in  $A', D', S'$ . Let  $|S'| = \mu, |A'| = \alpha, |D'| = \delta$ . W.l.o.g. we assume that  $\alpha \geq \delta$  (the case  $\alpha \leq \delta$  is symmetric). Recall that for each vertex  $v_a \in A', v_d \in D'$ , we have  $N(v_a) \cap N(v_d) \subseteq S'$ . Therefore since each vertex of  $S'$  has exactly one neighbor in  $A'$  and one neighbor in  $D'$ , it follows that  $\mu \geq \alpha\delta$ . From the above properties, if  $\mu > \alpha + \delta$ , then there is a vertex  $v \in S'$  that cannot be matched with a vertex of  $A'$  or  $D'$ . So  $G'$  has no matching-cut. Now  $\mu \leq \alpha + \delta$ . Therefore  $\alpha + \delta \geq \alpha\delta$ , and so  $\alpha = \delta = 2$  or  $\delta = 1, \alpha \geq 1$ .

Let  $\alpha = \delta = 2$ . We denote  $A' = \{v_a^1, v_a^2\}, D' = \{v_d^1, v_d^2\}, S' = \{v_1, v_2, v_3, v_4\}$ . Then  $G'$  consists of the four paths  $v_a^1 - v_1 - v_d^1, v_a^1 - v_2 - v_d^2, v_a^2 - v_3 - v_d^1, v_a^2 - v_4 - v_d^2$ . There exist two perfect matchings of  $G'$ , that are,  $M_a = \{v_a^1 v_1, v_d^2 v_2, v_d^1 v_3, v_a^2 v_4\}, M_d = \{v_a^1 v_2, v_d^2 v_4, v_d^1 v_1, v_a^2 v_3\}$ .

Let  $\delta = 1$ . We have  $\alpha \leq \mu \leq \alpha + 1$ . We denote  $A' = \{v_a^1, \dots, v_a^\alpha\}, D' = \{v_d\}, S' = \{v_1, \dots, v_\mu\}$ , and we assume that  $v_a^i v_i \in E, 1 \leq i \leq \mu$ . First  $\mu = \alpha$ . Then  $G'$  consists of  $\alpha$  paths  $v_a^1 - v_1 - v_d, \dots, v_a^\alpha - v_\alpha - v_d$ . So in  $G'$  there exist  $\alpha + 1$  matchings that disconnect  $A'$  from  $D'$ . Those matchings are  $M_0 = \{v_a^1 v_1, \dots, v_a^\alpha v_\alpha\}$  and  $M_i = \{v_i v_d\} \cup \{v_a^j v_j, 1 \leq j \leq \alpha, j \neq i\}$ . Second  $\mu = \alpha + 1$ . Then  $G'$  consists of the two paths  $v_a^1 - v_1 - v_d, v_a^1 - v_2 - v_d$  and the  $\alpha - 1$  paths  $v_a^2 - v_3 - v_d, \dots, v_a^\alpha - v_{\alpha+1} - v_d$ . There exist exactly two matchings of  $G'$  that disconnect  $A'$  from  $D'$ , that are  $\bar{M}_1 = \{v_a^1 v_1, v_d v_2, v_a^2 v_3, \dots, v_a^\alpha v_{\alpha+1}\}$  and  $\bar{M}_2 = \{v_a^1 v_2, v_d v_1, v_a^2 v_3, \dots, v_a^\alpha v_{\alpha+1}\}$ .

By symmetry, to  $G'' = G[B' \cup C' \cup T']$  correspond the following matchings: either  $M'_0 = \{v'_a v'_1, \dots, v'^{\alpha'} v'_{\alpha'}\}$  and  $M'_i = \{v'_i v'_d\} \cup \{v'^j v'_j, 1 \leq j \leq \alpha', j \neq i\}$  or  $\bar{M}'_1 = \{v'_a v'_1, v'_d v'_2, v'^2 v'_3, \dots, v'^{\alpha'} v'_{\alpha'+1}\}$  and  $\bar{M}'_2 = \{v'_a v'_2, v'_d v'_1, v'^2 v'_3, \dots, v'^{\alpha'} v'_{\alpha'+1}\}$ .

So there are at most  $\mathcal{O}(|V|^2)$  combinations between the matchings of  $G'$  and  $G''$ . Recall that for each combination  $M', M''$ , each vertex  $u \in S' \cup T'$  is covered by an edge  $uv \in M' \cup M''$  where  $v \in A' \cup B' \cup C' \cup D'$ . Also, there is an edge  $uv' \notin M$  where  $v \in A' \cup B' \cup C' \cup D'$ . Moreover either  $v \in X$  and  $v' \in Y$ , or  $v \in Y$  and  $v' \in X$ . So if  $v \in X$ , then we set  $Y \leftarrow Y \cup \{v\}$ . Otherwise we set  $X \leftarrow X \cup \{v\}$ . Afterward  $X \cup Y$  is a partition of  $V$ . So it remains to check if  $E(X, Y)$  is a matching of  $G$ . If not, then we stop. Otherwise  $E(X, Y)$  is a matching-cut of  $G$ . Let  $Z_X \subseteq X, Z_Y \subseteq Y$  be the vertices not covered by an edge of  $E(X, Y)$ . We check if  $G[Z_X \cup Z_Y]$  has a perfect matching. If not, then  $(X, Y)$  is not extensible to a perfect matching-cut of  $G$ . So we stop. Otherwise  $M$  is a perfect matching of  $G[Z_X \cup Z_Y]$ , and so  $E(X, Y) \cup M$  is a perfect matching-cut of  $G$ .

We estimate the running time of our algorithm as follows. From [12], we know that computing a perfect matching in a bipartite graph takes  $\mathcal{O}(|V|^{\frac{5}{2}})$ . To check if there exists a perfect matching that contains a bridge can be done in time  $\mathcal{O}(|V|^{\frac{5}{2}})$ . Now, there are  $\mathcal{O}(|V|^2)$  pairs of edges  $ab, cd$ . Given a pair  $ab, cd$ , one can verify that the running time until the next pair is  $\mathcal{O}(|V|^{\frac{5}{2}})$ . Hence the complexity of the algorithm is  $\mathcal{O}(|V|^{\frac{9}{2}})$ .  $\square$

Now we give our result for the graphs with a diameter two.

**Theorem 3.11.** *PERFECT MATCHING-CUT is polynomial-time solvable for graphs of diameter at most 2.*

*Proof.* Let  $G = (V, E)$  be a graph such that  $\text{diam}(G) \leq 2$ . We can assume that  $G$  has a perfect matching. Let  $xy$  be an edge. We check if there exists a matching-cut  $E(X, Y)$  such that  $x \in X$  and  $y \in Y$ . From Fact 3.7, we set  $X \leftarrow X \cup N(X) \setminus \{y\}$  and  $Y \leftarrow Y \cup N(Y) \setminus \{x\}$ . If  $X \cap Y \neq \emptyset$  or if  $E(X, Y)$  is not a matching, then there is no matching-cut  $E(X, Y)$  with  $x \in A, y \in B$ . Else, since  $\text{diam}(G) \leq 2$ , it follows that  $X, Y$  is a partition of  $V$ . Let  $W$  be the set of vertices with no endpoint in  $M = E(X, Y)$ . If there is a perfect matching  $M'$  in  $G[W]$ , then  $M \cup M'$  is a perfect matching-cut of  $G$ . Otherwise, there is no perfect matching-cut that contains the cut  $M$ .  $\square$

*Remark 3.12.* The cliques are the graphs with diameter one. Hence  $K_2$  is the sole graph of diameter one that has a perfect matching-cut.

## 4 | PLANAR GRAPHS

We show the NP-completeness of PERFECT MATCHING-CUT for two subclasses of planar graphs. The first is when the degrees are restricted to be three or four, the second when the girth of the graph is five.

For our first proof we use the following decision problem.

### SEGMENT 3-COLORABILITY

*Instance:* A set of vertices  $V$  and three disjoint edge sets  $A, B, C$  such that  $G = (V, A \cup B \cup C)$  is a 3-regular planar multigraph with Hamiltonian cycle  $A \cup B$ .

*Question:* Is there a color function  $f: V \rightarrow \{1, 2, 3\}$  such that if  $uv \in A$ , then  $f(u) = f(v)$ , and if  $uv \in C$ , then  $f(u) \neq f(v)$ ?

**Theorem 4.1** (Bonsma [3]). *SEGMENT 3-COLORABILITY is NP-complete.*

The proof of the following theorem is inspired by the one of Bonsma for MATCHING-CUT for planar graphs in [3].

**Theorem 4.2.** *PERFECT MATCHING-CUT is NP-complete for planar graphs with vertex degrees  $\delta(v) \in \{3, 4\}$ .*

*Proof.* Given  $(V, A, B, C)$  an instance of SEGMENT 3-COLORABILITY with  $G = (V, A \cup B \cup C)$  we build, in polynomial-time, an instance  $G'$  of PERFECT MATCHING-CUT where  $G'$  is planar with maximum degree four. Afterward, from  $G'$  we build a planar graph  $G''$  with vertex degrees three or four such that  $G''$  has a perfect matching-cut if and only if  $G'$  has one.

We start by introducing the gadgets depicted in Figures 7 and 8 that are used to construct  $G'$ . Later, we describe how the gadgets connect in  $G'$ . For each of those gadgets, the six vertices on the left extremity are labeled  $l_i, l'_i$ , and the six vertices on the right extremity labeled  $r_i, r'_i$ , for  $i = 1, 2, 3$ . To every vertex  $v$  of  $G$  is associated a vertex-gadget  $g_v$  of  $G'$  as shown in Figure 7. Four orientations of the vertex-gadget are given in this figure. They will be used to maintain planarity in  $G'$  when we connect the gadgets. If two vertices  $u$  and  $v$  of  $G$  are connected by an  $A$ -edge  $e$ , then the vertex-gadgets  $g_u$  and  $g_v$  will

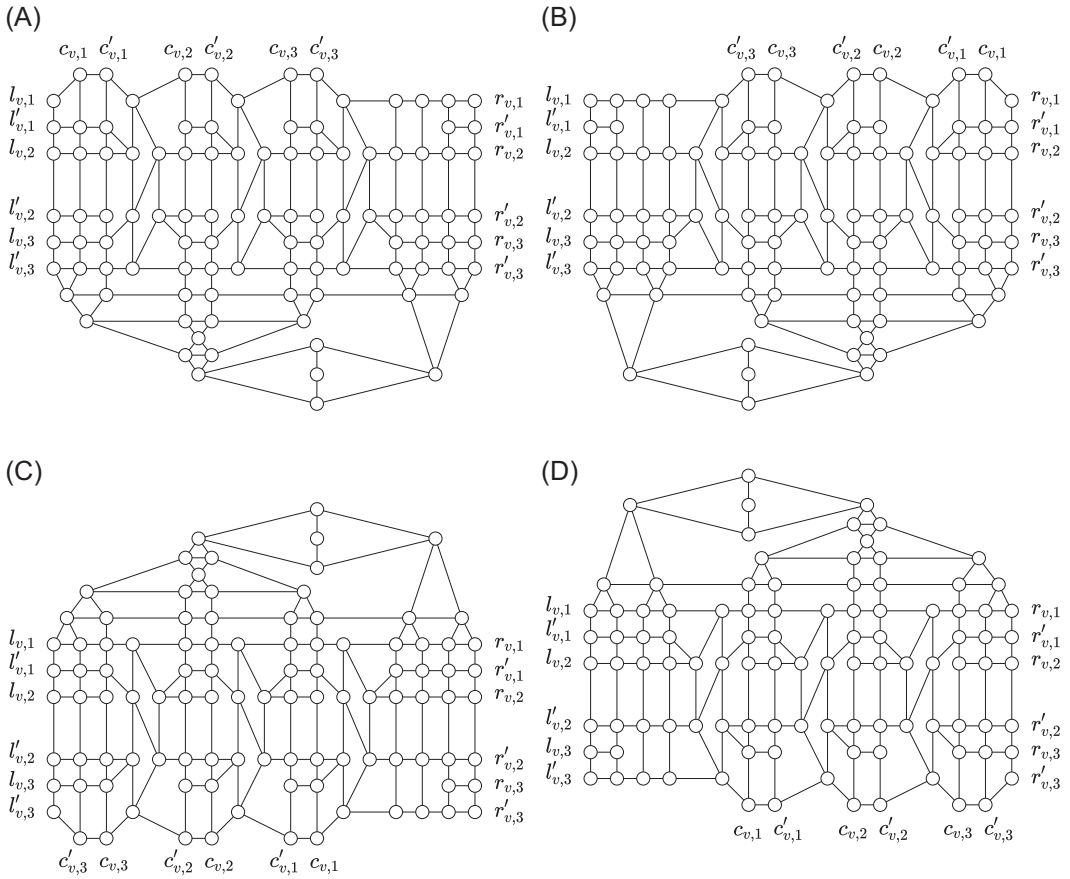

FIGURE 7 Four orientations of a vertex-gadget  $g_v$  (A) tail of inside edge-gadget, (B) head of inside edge-gadget, (C) tail of outside edge-gadget, and (D) head of outside edge-gadget.

be connected using the *A-edge-gadget*  $a_e$  (see Figure 8A). If two vertices  $u$  and  $v$  of  $G$  are connected by a *B-edge*  $e$ , then the vertex-gadgets  $g_u$  and  $g_v$  will be connected with the *B-edge-gadget*  $b_e$  (see Figure 8B). For two vertices  $u$  and  $v$  of  $G$  connected by a *C-edge*  $e$ , the vertex-gadgets  $g_u$  and  $g_v$  will be connected with a *C-edge-path*, that is, six disjoint 3-paths  $(c_{u,i} - d_i - c_{v,i}$  and  $c'_{u,i} - d'_i - c'_{v,i}, i = 1, 2, 3)$  as shown in Figure 8C. Since  $A \cup B$  is a Hamiltonian cycle and  $G$  is 3-regular, it follows that all vertices of  $G$  are incident to a *C-edge*. Therefore every vertex-gadget will be connected to another vertex-gadget by a *C-edge-path*.

Before connecting the gadgets together, we show how to orient the vertex-gadgets in  $G'$  so that we can connect two vertex-gadgets with a *C-edge-path* without destroying planarity. Consider a planar embedding of  $G$ . Orient all edges of the Hamiltonian cycle  $A \cup B$  counterclockwise with regard to the embedding. We say that a vertex  $u$  precedes  $v$  if there is an edge from  $u$  to  $v$  in the chosen embedding. Orient all edges of  $C$  arbitrarily. Since the edge set  $A \cup B$  gives a Hamiltonian cycle, it follows that this Hamiltonian cycle divides the plane into two regions in the embedding of  $G$ . Hence we can divide the edges of  $C$  into two categories using this Hamiltonian cycle: inside edges and outside edges. Recall that  $A \cup B$  is a Hamiltonian cycle of  $G$  and that  $G$  is 3-regular. Therefore every

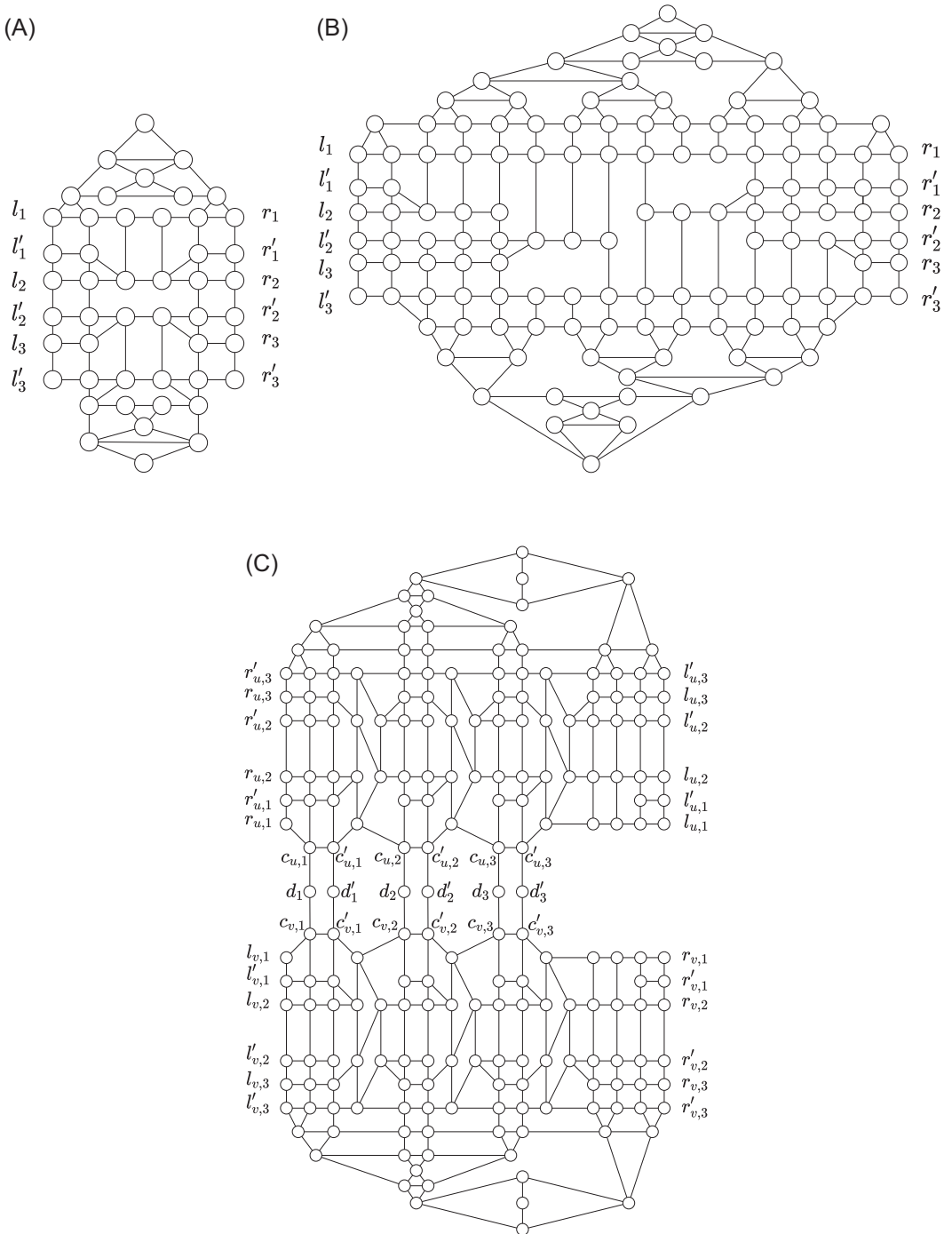

FIGURE 8 The three edge-gadgets in  $G'$ : (A) the  $A$ -edge-gadget, (B) the  $B$ -edge-gadget, and (C) two vertex-gadgets  $g_u, g_v$  connected by a  $C$ -edge-path where  $uv \in C$ .



vertex  $v$  of  $G$  is incident with exactly one edge  $e$  of  $C$ . We use this property to define four variants of a vertex-gadget  $g_v$ :

1. If  $e$  is an inside edge and  $v$  is incident with the tail of  $e$ , then orient  $g_v$  as shown in Figure 7A.
2. If  $e$  is an inside edge and  $v$  is incident with the head of  $e$ , then orient  $g_v$  as shown in Figure 7B.
3. If  $e$  is an outside edge and  $v$  is incident with the tail of  $e$ , then orient  $g_v$  as shown in Figure 7C.
4. If  $e$  is an outside edge and  $v$  is incident with the head of  $e$ , then orient  $g_v$  as shown in Figure 7D.

Note that the four variants of the vertex-gadget have different vertex labelings on their extremities.

We describe how two vertex-gadgets  $g_u$  and  $g_v$  are connected by an edge-gadget  $a_e$  or  $b_e$  in  $G'$ . We can suppose that  $u$  precedes  $v$ . The vertices  $r_{u,i}, r'_{u,i}$  of  $g_u$  are merged with the vertex  $l_i, l'_i$  of  $a_e$  (resp.,  $b_e$ ), respectively, for  $i = 1, 2, 3$ . We also merge the vertex  $l_{v,i}, l'_{v,i}$  of  $g_v$  with the vertex  $r_i, r'_i$  of  $a_e$  (resp.,  $b_e$ ), respectively, for  $i = 1, 2, 3$ .

It remains to describe how two vertex-gadgets  $g_u$  and  $g_v$  are connected by a  $C$ -edge-path. We can suppose that  $u$  precedes  $v$ . We link  $c_{u,i}$  to  $c_{v,i}$  and  $c'_{u,i}$  to  $c'_{v,i}$ , for  $i = 1, 2, 3$ , with two 3-paths  $c_{u,i} - d_i - c_{v,i}$  and  $c'_{u,i} - d'_i - c'_{v,i}$ . An example is shown in Figure 8C, where  $u$  and  $v$  are connected by an inside  $C$ -edge  $e$ ,  $v$  is the tail of  $e$ , and  $u$  is the head of  $e$ .

Since we have finished describing the gadgets and their connections, we show that  $G'$  is planar with maximum degree four.  $\square$

**Property 4.3.**  $G'$  is planar and  $\Delta(G') = 4$ .

*Proof.* All the gadgets associated with the vertices and the edges of  $G$  are planar with maximum degree four (see Figures 7 and 8). Moreover, the operations to connect the gadgets do not produce a vertex with degree more than four. Hence  $\Delta(G') = 4$ . From the planar embedding of  $G$ , and since  $A \cup B$  is a Hamiltonian cycle, it follows that we can place the vertex-gadgets, and the edge-gadgets on top of their corresponding vertex or edge without destroying planarity. For the  $C$ -edges, recall that they are either inside or outside the Hamiltonian cycle. Let  $g_u$  and  $g_v$  be two vertex-gadgets connected by a  $C$ -edge-path. If  $u$  and  $v$  are connected by an inside edge, then we can see from Figure 7A,B that the three paths connections between them do not overlap. Moreover, those paths can be placed on top of their corresponding  $C$ -edge in  $G$  without destroying planarity. If  $u$  and  $v$  are connected by an outside edge, then the same property can be checked by adding 3-paths between the vertex-gadgets of Figure 7C,D. So  $G'$  is planar and has maximum degree four.  $\square$

For each gadget of  $G'$ , we will show that the only possible matching-cuts are those depicted in Figures 9, 10, and 12.

Before that, we point out a few matching-cut properties of some induced subgraphs of  $G'$ . With these properties, given one edge of a gadget, one can either derive a matching-cut from it or conclude that no matching-cut contains this edge. Observe that most of the inner faces of the

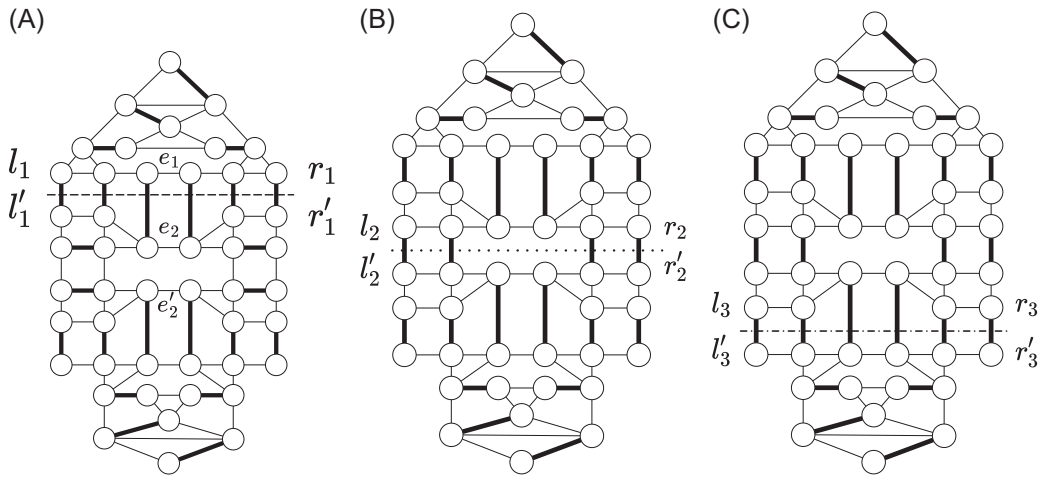

FIGURE 9 The three matching-cuts (A-C) through an  $A$ -edge-gadget  $a_e$  outlined by the dotted lines. The bold edges represent the corresponding perfect matching-cut.

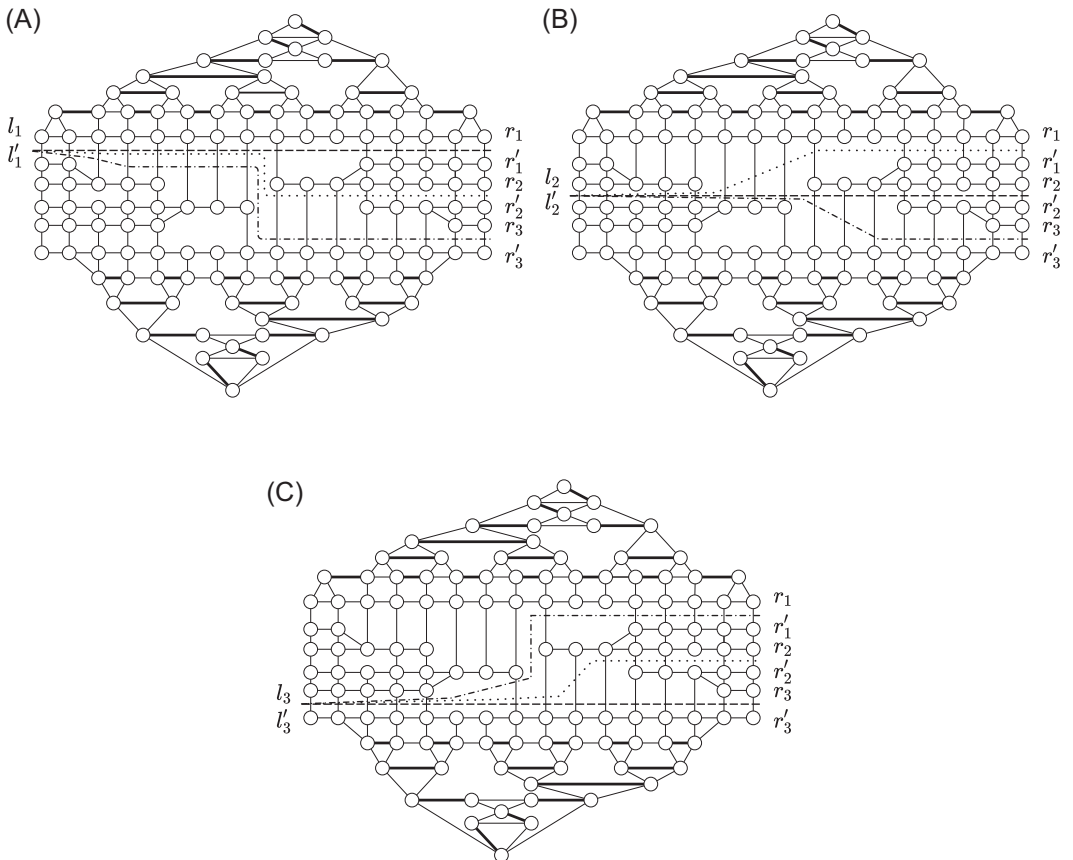

FIGURE 10 The nine matching-cuts (A-C) through a  $B$ -edge-gadget  $b_e$  outlined by the dotted lines. The bold edges represent a part of the corresponding perfect matching-cut.

gadgets have a length of at most four. The inner faces of length three are triangles which are immune. So no matching-cut of  $G'$  contains an edge of a triangle. Note that it is also the case for every immune subgraph of  $G'$  (such as  $K_{2,3}$ ). The inner faces of length four are  $C_4$ , and given a matching-cut  $M$ , either  $C_4$  has two edges in  $M$  or none. So given an edge of a  $C_4$ , one can check, with a little effort, that a derived matching-cut (if there is one) will be either from the left extremity to the right extremity, or from the top extremity to the bottom extremity of the gadgets drawings. Then, because of the immune subgraphs, we will see that every matching-cut is cutting the gadget “horizontally.”

We will show that the bold edges crossed by the dotted lines in Figures 9, 10, and 12 are mandatory to have a matching-cut in  $G'$ . Moreover, we show that each matching-cut is contained in a perfect matching, which is represented by all the other bold edges in the figures.

**Property 4.4.** Every  $A$ -edge-gadget has exactly three matching-cuts  $M_i$  ( $i = 1, 2, 3$ ) that are outlined in Figure 9. Also, each matching-cut is contained in a perfect matching.

*Proof.* Note that there is no matching-cut containing the edge  $l'_i l_{i+1}$  or  $r'_i r_{i+1}$  ( $i = 1, 2$ ) since this edge is induced in a  $C_4$  and that the remaining edge is in a triangle. Consider the horizontal edge  $e'_3$  with endpoint  $l'_3$ . Suppose  $e'_3$  is in a matching-cut. Because of the  $C_4$ , the horizontal edge with endpoint  $l_1$  is also in a matching-cut. Yet this edge belongs to a triangle. So  $e'_3$  belongs to no matching-cut and with similar arguments, we can conclude the same for the horizontal edge with endpoint  $r'_3$ .

Now consider the  $C_8$  at the center of the gadget. Because of the positions of the four triangles and the four squares that surround  $C_8$ , a matching-cut goes either horizontally or vertically through it. Suppose there is a vertical matching-cut  $M$ . Thus  $e_2 \in M$  or  $e'_2 \in M$  (see Figure 9A). Assume that  $e_2 \in M$ . So  $e_1 \in M$  because of the  $C_4$ . Then, because of the two triangles on the left and the right side,  $M$  must be cutting through the upper side of the gadget which is the graph induced by all eight vertices above  $l_1, r_1$ . Note that six vertices are in a triangle and every two triangles share a vertex. Therefore the six vertices form an immune subgraph. Take the two remaining vertices that are not in a triangle. Note that they both have two neighbors in the immune subgraph. Thus the eight vertices form an immune subgraph. So there is no vertical cut that is cutting through the top of the gadget. Therefore  $e_2 \notin M$ . With similar arguments, we can conclude that there is no matching-cut with  $e'_2 \in M$  that is cutting through the bottom of the gadget.

So, because of the triangles and the  $C_4$  it remains only the three matching-cuts of Figure 9. As shown in Figure 9 (as represented by the bold edges), each matching-cut is contained in a perfect matching.  $\square$

Note that the three matching-cuts  $M_i$  ( $i = 1, 2, 3$ ) of the  $A$ -edge-gadget contain the two edges  $l'_i l'_i, r'_i r'_i$ .

**Property 4.5.** Every  $B$ -edge-gadget has exactly nine matching-cuts  $M_{i,j}$  ( $i, j = 1, 2, 3$ ) that are outlined in Figure 10. Also, each matching-cut is contained in a perfect matching.

*Proof.* Note that there is no matching-cut containing the edge  $l'_i l_{i+1}$  or  $r'_i r_{i+1}$  ( $i = 1, 2$ ) because of the  $C_4$  and the triangle. First, we consider the subgraph  $B_H$  induced by the vertices not covered by a bold edge in Figure 10A. Since  $B_H$  can be partitioned into two isomorphic subgraphs  $B_L$  and  $B_R$  (left and right parts of the figure), we focus on the

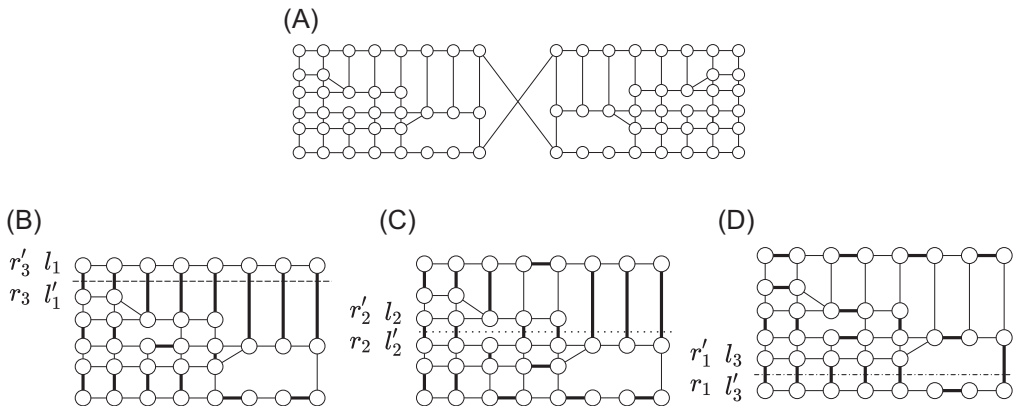

**FIGURE 11** (A) Another drawing of the subgraph  $B_H$  to reveal the symmetry between  $B_L$  and  $B_R$ . (B–D) The three matching-cuts of  $B_L$  outlined by the dotted lines. The bold edges represent the corresponding perfect matching-cut.

subgraph  $B_L$ , which is depicted in Figure 11. Suppose that there is no matching-cut cutting through the edges of the top border or of the lower border of  $B_L$ . With similar arguments used for the matching-cuts of  $a_e$ , one can check that only three horizontal matching-cuts are outlined in Figure 11B–D (because of the  $C_4$  and the triangles). Now we return to the entire  $B$ -edge-gadget. One can check that there is no matching-cut passing through the upper extremity or the lower extremity because of the triangles. Hence there is no matching-cut of  $b_e$  that is passing through the bottom or the top of  $B_L$  or  $B_R$ . Note that each of the three matching-cuts of  $B_L$  is compatible with the three cuts of  $B_R$  when they are connected in  $b_e$ . So there are exactly nine matching-cuts which are outlined in Figure 10. As shown in Figure 10 (as represented by the bold edges), each matching-cut is contained in a perfect matching.  $\square$

Note that for each  $i, j \in \{1, 2, 3\}$ , there is a matching-cut  $M_{i,j}$  containing the edges  $l_i l'_j, r_j r'_i$ .

**Property 4.6.** Every vertex-gadget  $g_v$  has at most three matching-cuts  $M_i$  ( $i = 1, 2, 3$ ) that are contained in the matching-cuts of  $G'$ . They are outlined in Figure 12. Also, each matching-cut is contained in a perfect matching.

*Proof.* Recall that in  $G'$ , for  $i = 1, 2, 3$ , the vertex  $l_{v,i}, l'_{v,i}$  of  $g_v$  is merged, respectively, with the vertex  $r_i, r'_i$  of an edge-gadget. It is the same for the vertex  $r_{v,i}, r'_{v,i}$  of  $g_v$  with the vertex  $l_i, l'_i$  of an edge-gadget. From Properties 4.4 and 4.5, there is no matching-cut of the edge-gadgets containing the edge  $l'_i l'_{i+1}$  or  $r'_i r'_{i+1}$ , for  $i = 1, 2$ . So there is no matching-cut of  $G'$  that contains the edge  $l'_{v,i} l_{v,i+1}$  or  $r'_{v,i} r_{v,i+1}$  ( $i = 1, 2$ ). So, with similar arguments used for the matching-cuts of  $a_e$ , one can check that the only three matching-cuts that do contain the edge  $l'_{v,i} l_{v,i+1}$  or  $r'_{v,i} r_{v,i+1}$ , for  $i = 1, 2$ , are outlined in Figure 12 (because of the  $C_4$ , the triangles, and the  $K_{2,3}$ ). As shown in Figure 12 (as represented by the bold edges), each matching-cut is contained in a perfect matching.  $\square$

Note that for  $i = 1, 2, 3$ , the edges  $l_{v,i} l'_{v,i}, r_{v,i} r'_{v,i}, c_{v,i} c'_{v,i}$  belong to the matching-cut  $M_j$  if and only if  $i = j$ . This is true for the four variants of the vertex-gadget, even though they have

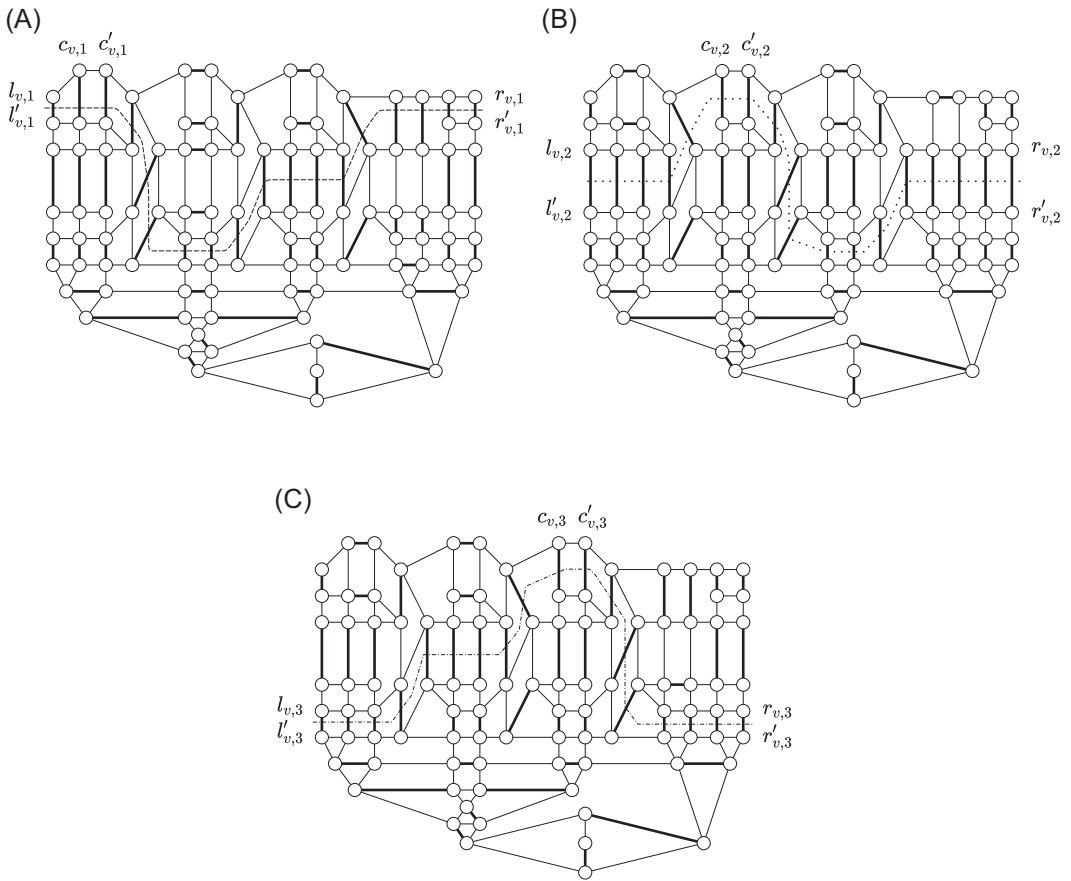

**FIGURE 12** The three matching-cuts (A–C) through a vertex-gadget  $g_v$ , outlined by the dotted lines. The bold edges represent the corresponding perfect matching-cut of  $g_v$ .

different labelings. So, for a vertex-gadget  $g_v$  of  $G'$ , if the edge  $l_i l'_i$  is in the matching-cut, we say that  $g_v$  is cut by  $i$  ( $i = 1, 2, 3$ ). Below, a cut  $i$  of  $g_v$  will correspond to a coloring of the vertex  $v$  in  $G$ .

We show how two vertex-gadgets  $g_u$  and  $g_v$  are cut if they are connected by an edge-gadget. We can suppose that  $u$  precedes  $v$ . Therefore, for  $i = 1, 2, 3$ , the two vertices  $r_{u,i}, r'_{u,i}$  and  $l_{v,i}, l'_{v,i}$  are merged, respectively, with the vertex  $l_i, l'_i$  and  $r_i, r'_i$  of an edge-gadget.

Suppose that  $g_u$  and  $g_v$  are connected by an  $A$ -edge-gadget  $a_e$ . From Property 4.4,  $a_e$  has exactly three matching-cuts. Those matching-cuts either contain the edges  $l_1 l'_1, r_1 r'_1$ , or  $l_2 l'_2, r_2 r'_2$ , or  $l_3 l'_3, r_3 r'_3$ . Therefore, for  $i = 1, 2, 3$ , if the edge  $r_{u,i} r'_{u,i}$  is in a matching-cut, then  $l_{v,i} l'_{v,i}$  is also in the matching-cut. Then from Property 4.6, this connection between  $g_u$  and  $g_v$  leads to the following property:

**Property 4.7.** If two vertex-gadgets  $g_u$  and  $g_v$  are connected by an  $A$ -edge-gadget  $a_e$ , then for any matching-cut,  $g_u$  is cut by  $i$  if and only if  $g_v$  is cut by  $i$  ( $i = 1, 2, 3$ ).

Suppose that  $g_u$  and  $g_v$  are connected by a  $B$ -edge-gadget  $b_e$ . From Property 4.5,  $b_e$  has exactly nine matching-cuts. Each of those matching-cuts either contains the edge  $l_1 l'_1$ , or  $l_2 l'_2$ , or

$l_3l'_3$ . Then, each matching-cut containing the edge  $l_i l'_i$  ( $i = 1, 2, 3$ ) either contains the edge  $r_1 r'_1$ , or  $r_2 r'_2$ , or  $r_3 r'_3$ . Therefore, if an edge  $r_{u,i} r'_{u,i}$  ( $i = 1, 2, 3$ ) is in a matching-cut, then  $l_{v,j} l'_{v,j}$  ( $j = 1, 2, 3$ ) is in the matching-cut. Then from Property 4.6, this connection between  $g_u$  and  $g_v$  leads to the following property:

**Property 4.8.** If two vertex-gadgets  $g_u$  and  $g_v$  are connected by a  $B$ -edge-gadget  $b_e$ , then for every matching-cut,  $g_u$  is cut if and only if  $g_v$  is cut. Every combination of cuts through  $g_u$  and  $g_v$  is possible.

So it remains to show how two vertex-gadgets  $g_u$  and  $g_v$  are cut if they are connected by a  $C$ -edge-path. Even though every combination of cuts between  $g_u$  and  $g_v$  is possible, we show that this is not the case when the cut is contained in a perfect matching.

**Property 4.9.** If two vertex-gadgets  $g_u$  and  $g_v$  are connected with a  $C$ -edge-path, then for every perfect matching-cut: if  $g_u$  is cut by  $i$ , then  $g_v$  is cut by  $j$ ,  $i \neq j$ .

*Proof.* If  $g_u$  is cut by  $i$ , then the vertex  $c_{u,i}$  (resp.,  $c'_{u,i}$ ) is covered by the matching (from an edge of  $g_u$ ). Suppose, for contradiction, that  $g_v$  is cut by  $i$ . Thus  $c_{v,i}$  (resp.,  $c'_{v,i}$ ) is also covered by the matching (from an edge of  $g_v$ ). Since  $c_{u,i}$  (resp.,  $c'_{u,i}$ ) is connected by a 3-path to  $c_{v,i}$  (resp.,  $c'_{v,i}$ ), there is  $d_i$  (resp.,  $d'_i$ ) with degree two that is not covered by the matching. Yet, this vertex has both neighbors already covered by the matching-cut. So there is no perfect matching-cut such that  $g_u$  and  $g_v$  are cut by  $i$ .  $\square$

We give some properties of the perfect matching-cuts of  $G'$ . Note that  $G - C$  is connected. Therefore, the removal of every edge of the  $C$ -edge-paths does not disconnect  $G'$ . Because  $A \cup B$  is a Hamiltonian cycle in  $G$ , and the gadgets of  $G'$  have no matching-cuts other than those indicated by Properties 4.4–4.6, it follows that if  $G'$  has a matching-cut, then this matching-cut disconnects every gadget “horizontally” into two connected components.

We are ready to show that  $G'$  has a perfect matching-cut if and only if  $G$  has a segment 3-coloring.

First, from a perfect matching-cut  $M$  of  $G'$ , we build a segment 3-coloring of  $G$ . Let  $f$  be a color function. From previous arguments, the intersection between every vertex-gadget  $g_v$  and the perfect matching-cut is a cut  $i$  ( $i = 1, 2, 3$ ). Thus for every vertex  $v$  of  $G$ , we set  $f(v) = i$ . Therefore, from Property 4.7, if  $uv \in A$ , then  $f(u) = f(v)$ . Moreover, from Property 4.9, if  $uv \in C$ , then  $f(u) \neq f(v)$ . So  $f$  is a segment 3-coloring function of  $G$ .

Reciprocally, from a segment 3-coloring of  $G$ , we build a perfect matching-cut  $M$  of  $G'$ . For every vertex  $v$  of  $G$  with color  $i$ , we add the edges corresponding to the cut  $i$  of  $g_v$  to  $M$ . Therefore, for every edge  $uv \in C$ , the vertex-gadgets  $g_u$  and  $g_v$  have different cuts  $i$  and  $j$ , respectively. So we add the edges  $c_{u,j} d'_j$ ,  $c'_{u,j} d_j$ ,  $c_{v,i} d_i$ ,  $c'_{v,i} d'_i$ ,  $c_{u,k} d_k$ ,  $c'_{u,k} d'_k$  ( $i \neq j \neq k$ ) to  $M$ . Thus every vertex of the  $C$ -edge-paths is covered by  $M$ . Also, note that there is no path from  $g_u$  to  $g_v$  in  $G' - M$  that goes through a  $C$ -edge-path. From Property 4.6, we can extend every cut  $i$  of a vertex-gadget to a perfect matching-cut. Thus we add the necessary edges to  $M$  so that we cover every vertex of the vertex-gadgets. Then, for each  $A$ -edge-gadget  $a_e$ , where  $e = uv \in A$ , the vertex-gadgets  $g_u$  and  $g_v$  are cut by  $i$ . So from Property 4.4, we can add the edges of the perfect matching-cut of  $a_e$  containing the edges  $l_i l'_i$  and  $r_i r'_i$ . For each  $B$ -edge-gadget  $b_e$ , where  $e = uv \in B$ , the vertex-gadgets  $g_u$  and  $g_v$  are cut by  $i, j$ , respectively, where  $i, j \in \{1, 2, 3\}$ . So

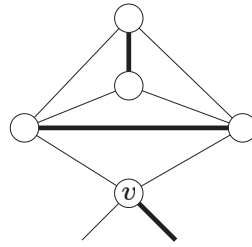

**FIGURE 13** How to replace  $v$  a vertex of degree two in  $G'$  by adding four new vertices of degree three or four.

from Property 4.5, we can add the edges of the perfect matching-cut of  $b_e$  containing the edges  $l_i l'_i$  and  $r_j r'_j$ . It follows that  $M$  is a perfect matching-cut of  $G'$ .

So for each perfect matching-cut of  $G'$  corresponds a segment 3-coloring, and to each segment 3-coloring of  $G$  correspond a perfect matching-cut of  $G'$ .

To complete this proof, we describe how to transform  $G'$  into a planar graph  $G''$  with vertex degrees  $d(v) \in \{3, 4\}$ , such that  $G'$  has a perfect matching-cut if and only if  $G''$  has a perfect matching-cut. Observe that for each vertex  $v$  of  $G'$ , we have  $d(v) \in \{2, 3, 4\}$ . For every vertex  $v$  of  $G'$  such that  $d(v) = 2$ , we add the gadget  $H$  that has four vertices as shown in Figure 13. The resulting graph  $G''$  is planar with  $\delta(G) = 3$  and  $\Delta(G) = 4$ . Since  $H = K_4$ , it follows that  $H$  is immune and has a perfect matching. Observe that there is no perfect matching of  $G''$  containing an edge  $uv$ , where  $u \in V(H)$ ,  $v \in V(G')$ . Therefore, any perfect matching-cut of  $G'$  can be extended to a perfect matching-cut of  $G''$ , and any perfect matching-cut of  $G''$  contains a perfect matching-cut of  $G'$ . The result follows and this completes the proof.

In the proof of Theorem 4.2, we remark that the triangles are of great importance since they are immune. Hence, the question arises whether PERFECT MATCHING-CUT is still NP-complete for planar graphs with large girth.

For MATCHING-CUT, Moshi [15] showed that every edge  $uv$  could be replaced by a cycle of length four ( $C_4 = u - u_1 - v - v_1 - u$ ), resulting in an equivalent bipartite graph instance. Hence MATCHING-CUT remains NP-complete for bipartite planar graphs with maximum degree eight. Unfortunately, this construction does not work for PERFECT MATCHING-CUT, and it does not seem feasible to achieve similar result by replacing edges with gadgets. Bonsma [3] also showed that MATCHING-CUT is NP-complete for planar graphs with girth five, while for planar graphs with girth at least six, Bonsma et al. [4] showed that every such graph has a matching-cut. We were not able to obtain similar results for bipartite graphs and graphs of girth six, but we prove below the NP-completeness of PERFECT MATCHING-CUT for planar graphs with girth five by replacing each edge with the subgraph shown in Figure 14.

**Theorem 4.10.** *PERFECT MATCHING-CUT is NP-complete for planar graphs with girth five.*

*Proof.* By Theorem 4.2 PERFECT MATCHING-CUT is NP-complete for planar graphs. Given  $G = (V, E)$  a planar graph, we build (in polynomial-time)  $G' = (V', E')$  a planar graph with girth five as follows. Replace every edge  $uv$  of  $G$  by the gadget  $H_{uv}$  as shown in Figure 14A. We observe that the resulting graph  $G'$  is planar. Since  $H_{uv}$  has girth five, and that the distance between  $u$  and  $v$  in  $H_{uv}$  is three, it follows that  $G'$  is planar with girth five.



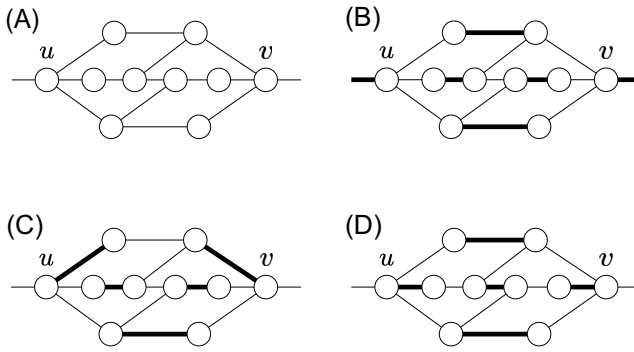

FIGURE 14 (A) The planar gadget  $H_{uv}$  with girth five, (B) the perfect matching  $M_3$  of  $H = H_{uv} \setminus \{u, v\}$ , and (C, D) the two perfect matching-cuts  $M_1, M_2$  of  $H$ .

We start by giving some properties of  $H_{uv}$  and  $H = H_{uv} \setminus \{u, v\}$ . Up to symmetry,  $H_{uv}$  has only two perfect matchings  $M_1, M_2$  that are represented by the bold edges in Figure 14C,D. Both perfect matchings  $M_1, M_2$  contain a cut, and  $H_{uv} - M_1, H_{uv} - M_2$  are composed of exactly two connected components  $C_u, C_v$ , where  $u \in C_u$  and  $v \in C_v$ . For  $H = H_{uv} \setminus \{u, v\}$ , it has a unique perfect matching  $M_3$  that is exposed in Figure 14B, and this perfect matching contains no cut. Therefore, given a matching  $M'$  of  $G'$ , we say that a gadget  $H_{uv}$  is cut if  $M' \cap E(H_{uv}) = M_i$  ( $i = 1, 2$ ).

From a perfect matching-cut  $M'$  of  $G'$ , we obtain  $M \subseteq E$  as follows. For each  $H_{uv}$  that is cut by  $M'$ , we add  $uv$  to  $M$ . From the above properties, if  $H_{uv}$  is cut by  $M'$ , then every  $H_{ux}, H_{vy}$ , where  $x \in N_G(u) \setminus \{v\}, y \in N_G(v) \setminus \{u\}$ , are not cut by  $M'$ . Also for every  $u \in V$ , there is exactly one  $H_{ux}$ , where  $x \in N(u)$ , that is cut by  $M'$ . Therefore  $M$  is a perfect matching of  $G$ . Since  $M'$  is cutting exactly the gadgets  $H_{uv}$  that correspond to the taken edges  $M$  of  $G$ , it follows that  $M$  is a perfect matching-cut of  $G$ .

Conversely, from a perfect matching-cut  $M$  of  $G$ , we obtain  $M' \subseteq E'$  as follows. For each  $uv \in M$ , we add the edges of  $M_1$  to  $M'$ . Since those  $H_{uv}$  are cut by  $M'$ , it follows that  $M'$  is a matching-cut of  $G$ . Then, for each  $uv \notin M$ , we add the edges of  $M_3$  to  $M'$ . So all the vertices of the gadgets  $H_{uv}$  are covered by  $M'$ , and thus  $M'$  is a perfect matching-cut. This completes the proof.  $\square$

We continue our study of some subclasses of planar graphs. We will see in Section 6 that PERFECT MATCHING-CUT can be solved in polynomial-time in claw-free graphs. Therefore, it is of interest to know if this problem is solvable in polynomial-time for some  $H$ -free graphs containing the claw. The graph  $K_{1,4}$  is the smallest star (in edges and vertices) containing the claw as an induced subgraph. Unfortunately, we show that PERFECT MATCHING-CUT is NP-complete for  $K_{1,4}$ -free graphs (and even if the graphs are planar with maximum degree four).

**Theorem 4.11.** *PERFECT MATCHING-CUT is NP-complete for planar  $K_{1,4}$ -free graphs with vertex degrees  $\delta(v) \in \{3, 4\}$ .*

*Proof.* From Theorem 4.2, PERFECT MATCHING-CUT is NP-complete for planar graphs with vertex degrees  $\delta(v) \in \{3, 4\}$ . Given such a graph  $G = (V, E)$ , we will build (in polynomial-time) a planar  $K_{1,4}$ -free graphs  $G'$  with vertex degrees  $\delta(v) \in \{3, 4\}$ . First, we

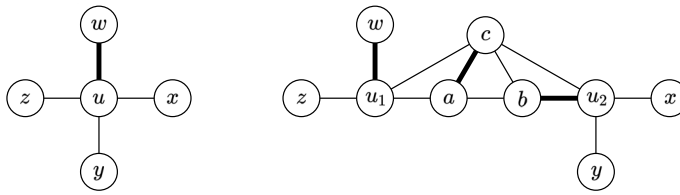

FIGURE 15 How to replace the vertex  $u$  by  $G_u$ .

show the operation to remove an induced  $K_{1,4}$  of  $G$  and give some properties of the resulting graph  $H$ . Then we prove that  $H$  has a perfect matching-cut if and only if  $G$  has a perfect matching-cut. Let  $u \in V$  be a vertex at the center of a  $K_{1,4} = G[\{u, w, x, y, z\}]$ . Let  $H$  be the graph obtained from  $G$  by replacing  $u$  with the subgraph  $G_u$  as shown in Figure 15. Observe that  $H$  is planar with vertex degrees  $\delta(v) \in \{3, 4\}$ , and that  $H$  has one less induced  $K_{1,4}$  than  $G$ . Since  $G_u$  is immune (every edge is in a triangle) and  $G_u \setminus \{u_1, u_2\}$  is odd, it follows that every perfect matching-cut of  $H$  contains exactly one edge in  $\{au_1, cu_1, bu_2, cu_2\}$ , and exactly one edge in  $\{u_1w, u_1z, u_2x, u_2y\}$ .

Let  $M$  be a perfect matching-cut of  $G$ . W.l.o.g.  $uw \in M$ . Then  $M \cup \{u_1w, ac, bu_2\} \setminus \{uw\}$  is a perfect matching-cut of  $H$ . Reciprocally, let  $M'$  be a perfect matching-cut of  $H$ . W.l.o.g.  $bc, u_1a, u_2x \in M'$ . Since  $G_u$  is immune, it follows that  $M' \setminus \{bc, u_1a\}$  is a matching-cut of  $H$ . Therefore  $M' \cup \{ux\} \setminus \{bc, u_1a, u_2x\}$  is a perfect matching-cut of  $G$ .

So by replacing each induced  $K_{1,4}$  from  $G$  as done above, we obtain a graph  $G'$  that is planar  $K_{1,4}$ -free with vertex degrees  $\delta(v) \in \{3, 4\}$  and such that  $G'$  has a perfect matching-cut if and only if  $G$  has one.  $\square$

The remainder of this section deals with cubic graphs. For cubic planar graphs, we know the following.

**Theorem 4.12** (Diwan). *Every planar cubic bridgeless graph except  $K_4$  has a perfect matching-cut.*

We deal with the cubic graphs that have a bridge.

**Property 4.13.** Let  $G = (V, E)$  be a cubic graph and  $W \subset E$  be its set of bridges. Then for every perfect matching  $M$  of  $G$ , we have  $W \subset M$ .

*Proof.* Let  $uv$  be a bridge of  $G$  and  $C$  be one of the two connected components of  $G - uv$ . Note that  $C$  is odd because it has an even number of vertices of degree 3 and exactly one vertex of degree 2. Therefore  $C$  has no perfect matching. So  $uv$  belongs to every perfect matching-cut of  $G$ .  $\square$

Hence every cubic graph that has a bridge and a perfect matching, also has a perfect matching-cut. So we have a complete overview for planar cubic graphs, that is:

**Corollary 4.14.** *Every planar cubic graph except  $K_4$  that has a perfect matching has a perfect matching-cut.*

Note that this does not hold for subcubic planar graph, see the graph on the left of Figure 1. Also, it does not hold for cubic (nonplanar) bridgeless graphs, because Diwan has shown in [8] that there exists an arbitrarily large class of cubic bridgeless graphs that have perfect matchings but no perfect matching-cut.

## 5 | $P_5$ -FREE GRAPHS

In this section we prove that PERFECT MATCHING-CUT is polynomial-time solvable for the class of  $P_5$ -free graphs. We use the two theorems below.

**Theorem 5.1** (Bacsó and Tuza [1]). *Let  $G$  be a connected  $P_5$ -free graph. Then  $G$  has a dominating clique or a dominating induced  $P_3$ .*

**Theorem 5.2** (Camby and Schaudt [5]). *Given a connected graph  $G$  on  $n$  vertices and  $m$  edges, one can compute in time  $O(n^5(n + m))$  a connected dominating set  $X$  with the following property: for the minimum  $k \geq 4$  such that  $G$  is  $P_k$ -free,  $G[X]$  is  $P_{k-2}$ -free or  $G[X]$  is isomorphic to  $P_{k-2}$ .*

This implies that for a connected  $P_5$ -free graph, we can compute a connected dominating set  $X$  such that  $G[X]$  is  $P_3$ -free or  $G[X] = P_3$  in polynomial-time. Note that a connected  $P_3$ -free graph is a clique. Hence it follows.

**Corollary 5.3.** *Given a connected  $P_5$ -free graph  $G$ , computing a connected dominating set that is either a  $P_3$  or a clique can be done in polynomial-time.*

We prove the following.

**Theorem 5.4.** *There is a polynomial-time algorithm with the following specifications:*

**Input:** *A connected  $P_5$ -free graph  $G$ .*

**Output:** *Either  $M$  a perfect matching-cut of  $G$ , or a determination that there is no perfect matching-cut.*

*Proof.* Let  $G = (V, E)$  be a connected  $P_5$ -free graph. If  $G$  has a leaf, then every perfect matching contains a cut. So we can assume that  $\delta(G) \geq 2$ . We give a description of the algorithm. First we compute  $D$  a dominating clique or a dominating  $P_3$  of  $G$ . If the graph induced by  $D$  is not immune, then we consider every  $X \subseteq D$ . Note that it can be done in polynomial-time because every nonimmune  $D$  is either  $P_2$  or  $P_3$ . Otherwise we only consider  $X = D$ . Then for each  $X$ , we either construct a matching-cut  $E(Z, V \setminus Z)$  such that  $X \subseteq Z$ , or we show that no such matching-cut exists. Last, if such a matching-cut exists, then we give either a perfect matching containing this cut, or we show that no perfect matching contains this cut.

For  $X \subseteq V$ , we define a procedure  $\mathcal{P}$  that identifies some vertices of  $V \setminus X$  that cannot be disconnected from  $X$  by a matching. The procedure  $\mathcal{P}$  works as follows. Do the following as long as possible: if there exists  $v \in V \setminus X$  with two neighbors in  $X$ , then  $X \leftarrow X \cup \{v\}$ ; if there exists  $x \in X$  with two neighbors  $u, v \in V \setminus X$  such that  $uv \in E$ , then

$X \leftarrow X \cup \{u, v\}$ . From Facts 2.1 and 2.4, the vertices added with the procedure  $\mathcal{P}$  cannot be disconnected from  $X$  by a matching-cut  $E(Z, V \setminus Z)$ ,  $X \subseteq Z$ . Therefore we can apply  $\mathcal{P}$  to  $X$ .

From 5.1,  $G$  has a dominating clique or a dominating  $P_3$ . Let  $D = \{d_1, \dots, d_p\}$  be one of those dominating sets. If  $p = 1$ , then every edge is in a triangle of  $G$ . So from Fact 2.1, it follows that there is no perfect matching-cut in  $G$ . If  $p = 2$ , then we consider  $X = \{v_1\}$  and then  $X = D$  (the other cases are symmetric). Below, this will be *Case 1* and *Case 3*, respectively. Now  $p \geq 3$ . If  $D$  is a clique, then from Fact 2.1,  $D$  is immune. So we can only construct a matching-cut with  $X = D$ . This will be *Case 3*. Otherwise  $D$  is a  $P_3 = d_1 - d_2 - d_3$ . We consider  $X = \{d_1, d_2\}$  and then  $X = D$  (the other cases are symmetric). This will be *Case 2* and *Case 3*, respectively. So we have three cases of  $X$  and for each case we apply  $\mathcal{P}$  to  $X$ . For each case, if there is no matching-cut  $E(X \subseteq X', V \setminus X')$  (i.e., contained in a perfect matching), then we say that  $X$  is not extensible to a (perfect) matching-cut of  $G$ .

Before dealing with each case separately, we show some properties of  $G[V \setminus X]$  when  $V \setminus X \neq \emptyset$ . For  $i = 1, \dots, p$ , let  $V_i = \{v \in V \setminus X : vd_i \in E\}$ . Because of  $\mathcal{P}$  and since  $D$  is a dominating set of  $G$ , it follows that for every  $v \in V \setminus X$ ,  $N(v) \cap X = \{d_i\}$  and  $N(v) \cap N(d_i) = \emptyset$ . Therefore  $V_1, \dots, V_p$  is a partition into independent sets of  $V \setminus X$ . We show that  $G[V \setminus X]$  is connected. Suppose not; since  $\delta(G) \geq 2$ , then there are two edges that belong to two distinct components of  $G[V \setminus X]$ . W.l.o.g. let  $u_1 u_2$  and  $v_j v_l$  ( $1 \leq j < l \leq p$ ) be those two edges. If  $j = 1$  or  $j = 2$ , then  $u_2 - u_1 - d_1 - v_1 - v_l = P_5$  or  $u_1 - u_2 - d_2 - v_2 - v_l = P_5$ , a contradiction. Otherwise  $j > 2$  and  $u_1 - u_2 - d_2 - d_j - v_j = P_5$  (if  $D = P_3$ , then  $j = 3$ ), a contradiction. So  $G[V \setminus X]$  is connected.

We are ready to deal with each case.

*Case 1.*  $X = \{d_1\}$  and  $D = \{d_1, d_2\}$ .

We try to construct a matching-cut that disconnects  $d_1$  from  $d_2$ . It follows that we must cut all edges between  $X_1 = N[d_1] \setminus \{d_2\}$  and  $X_2 = N[d_2] \setminus \{d_1\}$ . Hence if  $X_1 \cap X_2 \neq \emptyset$  or  $E(X_1, X_2)$  is not a matching, then  $(X_1, X_2)$  is not extensible to a matching-cut of  $G$ . So we go to *Case 3*. Otherwise, let  $W$  be the endpoints of  $E(X_1, X_2)$ . Then let  $M'$  be a maximum matching of  $G - W$ . If  $M'$  is a perfect matching of  $G - W$ , then  $M = E(X_1, X_2) \cup M'$  is a perfect matching-cut of  $G$ . Otherwise  $X$  is not extensible to a perfect matching-cut of  $G$ . So we go to *Case 3*.

*Case 2.*  $X = \{d_1, d_2\}$  and  $D = P_3 = d_1 - d_2 - d_3$ .

We try to construct a matching-cut that disconnects  $d_1, d_2$  from  $d_3$ . It follows that we must cut all edges between  $X_{1,2} = N[d_1] \cup N[d_2] \setminus \{d_3\}$  and  $X_3 = N[d_3] \setminus \{d_2\}$ . Hence if  $X_{1,2} \cap X_3 \neq \emptyset$  or  $E(X_{1,2}, X_3)$  is not a matching, then  $(X_1, X_2)$  is not extensible to a matching-cut of  $G$ . So we go to *Case 3*. Otherwise, let  $W$  be the endpoints of  $E(X_{1,2}, X_3)$ . Let  $M'$  be a maximum matching of  $G - W$ . If  $M'$  is a perfect matching, then  $M = E(X_{1,2}, X_3) \cup M'$  is a perfect matching-cut of  $G$ . Otherwise,  $X$  is not extensible to a perfect matching-cut of  $G$ . So we go to *Case 3*.

*Case 3.*  $X = D$  and  $D$  is either a clique of size at least two or a  $P_3$ .

We try to construct a matching-cut such that  $d_1$  is connected to  $d_2$ . So if  $V = X$  and  $p = 2$ , then  $X$  is not extensible to a matching-cut of  $G$ . Thus with *Case 1*, we can conclude that  $G$  has no perfect matching-cut. If  $V = X$  and  $D = P_3$ , then  $X$  is not

extensible to a matching-cut of  $G$ . Thus with *Case 2*, we can conclude that  $G$  has no perfect matching-cut. If  $V = X$ , and  $D$  is a clique of size at least three, then  $G$  is immune, and thus  $X$  is not extensible to a matching-cut of  $G$ . Otherwise  $V \neq X$ . We show that if  $X$  is extensible to a matching-cut, then this matching-cut is exactly  $E(X, V \setminus X)$ . Suppose not; then there is  $X' \supset X$  such that  $E(X', V \setminus X')$  is a matching-cut of  $G$ . Since  $G[V \setminus X]$  is connected, there is a path  $P = u - \dots - v$  in  $G[V \setminus X]$  that contains a vertex that is not in  $X'$ . Recall that all vertices of  $V \setminus X$  have a neighbor in  $D$ ,  $D \subseteq X'$ . So there is  $x \in P \setminus X'$  with two neighbors in  $X'$  (one in  $P \cap X'$  and one in  $D$ ), a contradiction. Thus, if  $E(X, V \setminus X)$  is not a matching, then  $G$  has no perfect matching-cut. Otherwise, let  $M_1 = E(X, V \setminus X)$ . Let  $W$  be the vertices that are covered by  $M_1$ . Let  $M_2$  be a maximum matching of  $G[V \setminus W]$ . If all vertices of  $V \setminus W$  are covered by  $M_2$ , then  $M = M_1 \cup M_2$  is a perfect matching-cut of  $G$ . Otherwise, there is no perfect matching-cut in  $G$ .

By Corollary 5.3 computing a  $P_3$  dominating set or a clique dominating set is polynomial. Computing a maximum matching is polynomial. Hence the previous algorithm is polynomial.  $\square$

**Corollary 5.5.** *PERFECT MATCHING-CUT is polynomial-time solvable for the classes of cographs, split graphs, and cobipartite graphs.*

*Proof.* These classes of graphs are subclasses of the class of  $P_5$ -free graphs.  $\square$

## 6 | CLAW-FREE GRAPHS

We show that PERFECT MATCHING-CUT is polynomial-time solvable for the class of claw-free graphs. To prove this, we will use the following theorem of Sumner [16] on claw-free graphs.

**Theorem 6.1.** *Every connected claw-free graph with an even number of vertices has a perfect matching.*

We are ready to establish our result.

**Theorem 6.2.** *PERFECT MATCHING-CUT is polynomial-time solvable for connected claw-free graphs.*

*Proof.* By Fact 2.6 we can assume that  $G$  has a perfect matching and  $\delta(G) \geq 2$ .

Assume that  $G$  has an induced path  $P = a - b - c - d$  with  $d(b) = d(c) = 2$ . Let  $G' = G - bc$ . If  $G'$  has a perfect matching  $M'$ , then  $ab, cd \in M'$  and  $M'$  is a perfect matching-cut of  $G$ . Otherwise  $G'$  has no perfect matching so from Theorem 6.1 it is not connected, and thus  $bc$  is bridge that belongs to every perfect matching of  $G$ . So now we suppose that  $G$  has no such induced path  $P$ .

If  $G$  is  $C_3$ -free, then  $G$  is an even induced cycle. Therefore every perfect matching of  $G$  is a perfect matching-cut. Now  $G$  contains a triangle  $C_3 = \{a, b, c\}$ . From Fact 2.1C is immune. Thus for every (perfect) matching-cut  $(X, V \setminus X)$ , there is  $C_3 \subseteq X$ . We show how to build  $C$  an immune cluster, with  $\{a, b, c\} \subseteq C \subseteq V$ . We initialize  $C = \{a, b, c\}$ . We do the following two operations, in the following order, and as long as possible.

**Rule 1.** *there exists  $v \notin C$  with two neighbors  $s, t \in C$ : then  $C \leftarrow C \cup \{v\}$ . We can apply this operation with  $C$ , since from Fact 2.4, every perfect matching-cut  $(C \subset X, V \setminus X)$  of  $G$  is such that  $v \in X$ .*

**Rule 2.** *there exists  $v \in C$  with two neighbors  $s, t \notin C$ : then  $C \leftarrow C \cup \{s, t\}$ . We show that we can apply this operation with  $C$ . Note that  $v$  has a neighbor  $w \in C$  which is not a neighbor of  $s, t$  (by Rule 1). Since  $G$  is claw-free, it follows that  $\{s, t, v\}$  induces a triangle in  $G$ , and a triangle is immune. Therefore every perfect matching-cut  $(C \subset X, V \setminus X)$  of  $G$  is such that  $s, t \in X$ .*

Let  $\mathcal{C} = \{C\}$ . We apply the two previous operations for each triangle of  $V$  that is not already in a cluster of  $\mathcal{C}$ , until every triangle belongs to a cluster. Now  $\mathcal{C}$  is the set of clusters of  $G$ . Let  $V \setminus \mathcal{C}$  be the vertices that are not in a cluster. We give some properties of  $V \setminus \mathcal{C}$ . Let  $v \in V \setminus \mathcal{C}$ . Since  $G$  is claw-free and  $\delta(G) \geq 2$ , it follows that  $d(v) = 2$ . From Rule 1,  $v$  has at most one neighbor in the same cluster  $C$ . Then, since we can suppose that  $G$  has no induced path  $P = a - b - c - d$  such that  $d(b) = d(c) = 2$ , it follows that  $v$  has no neighbor in  $V \setminus \mathcal{C}$ . Therefore all vertices of  $V \setminus \mathcal{C}$  have exactly two neighbors that are in two distinct clusters.

We say that two distinct clusters  $C, C'$  are *linked* if there exists a path  $P = u - \dots - v$  with  $u \in C, v \in C'$ , such that every vertex  $w$  of  $P, w \neq u, v$ , is not contained in a cluster. Note that from the previous paragraph, either  $P = u - v$  or  $P = u - w - v$ . Alternatively, we say that  $P$  is a *link* between  $C$  and  $C'$ . Notice that two clusters can have multiple links. Since  $G$  is claw-free and each cluster contains at least three vertices, it follows that two distinct links cannot have the same extremity. Hence, when there exists an edge between two links, the two endpoints of this edge are in the same cluster. Notice that every vertex of  $V \setminus \mathcal{C}$  belongs to a link.

Let  $C$  be a cluster. Its *core*  $K \subseteq C$  consists of all the vertices that are not an extremity of a link, that is,  $N[K] \subseteq C$ . Note that  $K$  is connected. The *corona* of  $C$  is  $Q = C \setminus K$ . Hence every  $v \in Q$  is the extremity of one link. We say that  $C$  is *even* when its core  $K$  is such that  $|K|$  is even, otherwise it is *odd*. Let  $H = (\mathcal{C}, \mathcal{E})$  be the graph where  $\mathcal{C}$  is the current set of clusters, and  $C_i C_j \in \mathcal{E}$  when there exists a link between  $C_i$  and  $C_j$ .

We consider the following cases numbered by the order they are performed in our algorithm (if *Case  $i$*  is not applicable, then we jump to *Case  $i + 1$* ):

*Case 1.* there exists exactly one cluster  $C \in \mathcal{C}$ , that is,  $C = V$ .

Since  $C$  is immune, it follows that  $G$  has no perfect matching-cut.

*Case 2.* there exists an even cluster  $C$  such that  $G[V \setminus C]$  is connected.

We will show that  $G$  has a perfect matching-cut. By Rule 1 and Rule 2, every vertex of the corona  $Q$  of  $C$  has exactly one neighbor in  $V \setminus C$ . Therefore  $M_Q = E(Q, N(Q) \setminus C)$  is a matching that cover all vertices of  $N[Q] \setminus K$ . Since vertices of  $Q$  are exactly the vertices of  $C$  with a neighbor in  $V \setminus C$ , it follows that  $M_Q$  is a matching-cut of  $G$ . We will show that there is always a perfect matching containing  $M_Q$ . By Theorem 6.1, the graph  $G[K]$  induced by the core  $K$  of  $C$  has a perfect matching  $M_K$  (because  $K$  is even and connected). So if  $G' = G[V \setminus N[C]]$  is connected and even, then  $G'$  has a perfect matching  $M_{G'}$ , and  $M_G \cup M_K \cup M_Q$  is a perfect matching-cut of  $G$ . Thus we show that  $G'$  is connected. By contradiction, we assume there exist two vertices  $s, t \in V \setminus N[C]$  that belong to two connected components of  $G'$ . Yet, there exists a path  $P$  between  $s$  and  $t$  in  $G[V \setminus C]$



because it is connected. We assume that  $P$  is a shortest path. Since  $G'$  is not connected, we can assume that  $P = s \cdots u - v - w \cdots t$  with  $v \in N(C) \setminus C$ . So  $v$  has a neighbor  $q \in Q$ . Recall that  $q$  has exactly one neighbor in  $V \setminus C$ . Thus  $qu, qw \notin E$ . Since  $P$  is a shortest path, it follows that  $uw \notin E$ . Then  $G[q, u, v, w]$  is a claw, a contradiction. So  $G'$  is connected. Therefore let  $M_G$  be a perfect matching of  $G'$ . Then  $M_G \cup M_Q \cup M_K$  is a perfect matching-cut of  $G$ .

*Case 3.* there exists an odd cluster  $C$  such that  $G[V \setminus C]$  is connected, and there is  $v \in N(C)$  that does not belong to any cluster.

We show that we can construct another cluster that satisfies the conditions of *Case 2*. By *Rule 1*, it follows that  $v$  has exactly one neighbor in the corona  $Q$  of  $C$ , say  $q$ . Note that  $v$  is the unique neighbor of  $q$  in  $V \setminus C$ , and that  $v$  belongs to a link. Thus  $d(v) = 2$ . Then we set  $C \leftarrow C \cup \{v\}$ . Now  $q$  belongs to the core of  $C$ , and  $v$  belongs to the corona of  $C$ . So  $C$  is an even cluster. Since  $v$  is a leaf in  $G[(V \setminus C) \cup \{v\}]$ , it follows that  $G[V \setminus C]$  is connected. Thus  $C$  is a cluster satisfying the conditions of *Case 2*, and so we return to this case. Recall that if *Case 2* is applicable, then  $G$  has a perfect matching-cut.

*Case 4.*  $H$  has a leaf  $C$ .

We show that there is no matching-cut of  $G$  that disconnects  $C$  from  $C'$ , where  $C'$  is the unique neighbor of  $C$  in  $H$ . Note that  $G[V \setminus C]$  is connected because  $C$  is a leaf in  $H$ . Since previous cases do not apply, it follows that the core  $K$  of  $C$  is odd, and that every  $v \in N(C)$  belongs to  $C'$ . Therefore  $G[K]$  has no perfect matching. So for every perfect matching  $M$  of  $G$ , there is an edge  $kq \in M$  where  $k \in K$  and  $q \in Q$  ( $Q$  is the corona of  $C$ ). Since there is  $qq' \in E$  where  $q' \in Q'$  ( $Q'$  is the corona of  $C'$ ), it follows that  $qq' \notin M$ . So  $C$  and  $C'$  cannot be disconnected by a perfect matching. Hence  $C$  and  $C'$  must be merged into a new cluster  $\bar{C} = C \cup C'$ . Thereby, the total number of clusters decreases by one unit, and we can recursively call the algorithm for the partition  $\mathcal{C}' = \{C \cup C'\} \cup (\mathcal{C} \setminus \{C, C'\})$ .

*Case 5.* there is a pair of odd clusters  $C, C'$  such that  $CC' \in \mathcal{E}$  and  $G[V \setminus (C \cup C')]$  is connected.

We show that we can construct another cluster that satisfies the conditions of *Case 2*. Note that  $G[V \setminus C]$  and  $G[V \setminus C']$  are connected. Thus, since *Case 3* is not applicable, it follows that the links between  $C$  and  $C'$  are edges, that is,  $E(C, C')$  is a matching of  $G$ . Let  $K, Q$  (resp.,  $K', Q'$ ) be the core and the corona of  $C$  (resp.,  $C'$ ). Let  $W$  be the endpoints of  $E(C, C')$  and let  $\bar{K} = K \cup K' \cup W$ . Note that  $\bar{K}$  is connected,  $|\bar{K}|$  is even, and that  $\bar{K}$  has no neighbor in  $V \setminus \bar{C}$  (where  $\bar{C} = C \cup C'$  is the new cluster containing  $\bar{K}$ ). Since  $G[V \setminus \bar{C}]$  is connected,  $\bar{C}$  is a cluster satisfying the conditions of *Case 2*. Therefore we remove the cluster  $C'$  from  $\mathcal{C}$ , and we set  $C \leftarrow \bar{C}$ . Then we return to *Case 2*. Recall that if *Case 2* is applicable, then  $G$  has a perfect matching-cut.

We will show that the algorithm covers all situations and that it terminates. If *Case 2* or *3* or *5* is applicable, then  $G$  has a perfect matching-cut. If *Case 4* is applicable, then there are two clusters  $C$  and  $C'$  that cannot be disconnected by a matching of  $G$ . So we merge them, and the number of clusters decrease by one. If *Case 1* is applicable, then all clusters have been merged (because of *Rule 1, 2* and *Case 4*), and so  $G$  has no perfect matching-cut. Therefore, we show that if *Cases 1–4* are not applicable, then *Case 5* is applicable. Suppose for contradiction that *Case 5* is not applicable. If there is  $CC' \in \mathcal{E}$



such that  $H \setminus \{C, C'\}$  is connected, then  $C$  or  $C'$  is even. Yet  $H \setminus \{C\}$  and  $H \setminus \{C'\}$  are connected, and so *Case 2* is applicable, a contradiction. So for every  $CC' \in \mathcal{E}$ , the graph  $H \setminus \{C, C'\}$  is disconnected. Let  $T$  be a spanning tree of  $H$ . Note that if  $T \setminus \{C, C'\}$  is connected, then  $H \setminus \{C, C'\}$  is also connected. From *Case 4*,  $H$  has no leaf, and so  $T$  has at least three vertices. Since  $T$  is a tree, there is a vertex  $C$  that is a neighbor of a leaf and such that  $T \setminus N[C]$  is connected. Let  $F$  be the set of leaves that are neighbors of  $C$  in  $T$ . If  $F = \{C'\}$ , then  $T - \{C, C'\}$  is connected, a contradiction. So  $|F| \geq 2$ . Since *Case 2* is not applicable, it follows that every vertex of  $F$  is odd. Then, since *Case 5* is not applicable, it follows that for every pair  $C', \bar{C} \in F$ ,  $C'\bar{C} \notin \mathcal{E}$ . Therefore  $F$  is an independent set of  $H$ . Therefore, since  $\delta(H) \geq 2$ , every  $C' \in F$  has a neighbor in  $\mathcal{C} \setminus (F \cup \{C\})$  in  $H$ . So for every  $C' \in F$ , it follows that  $H \setminus \{C, C'\}$  is connected, a contradiction. So there is  $CC' \in \mathcal{E}$  such that  $G[V \setminus (C \cup C')]$  is connected. Therefore, if *Cases 1–4* are not applicable, then *Case 5* is applicable.

It remains to show that the algorithm is polynomial. Recall that Edmonds' Algorithm computes a perfect matching in  $O(|E| \cdot |V|^2)$  (better algorithms are known). If  $\delta(G) = 1$ , then it suffices to compute a perfect matching. Checking if there exists an induced path  $P = a - b - c - d$ , with  $d_G(b) = d_G(c) = 2$  can be done in  $O(|V|^2)$ . Checking if  $G$  is an even induced cycle can be done in polynomial-time. At each step all the clusters are vertex-disjoint so there are at most  $O(|V|)$  clusters. Each cluster contains at least a triangle, so initializing the clusters takes at most  $O(|V|^3)$ . Applying *Rule 1* and *Rule 2* can be done in  $O(|V|^3)$ . Thus the initialization takes  $O(|V|^3)$ . Searching for two adjacent odd clusters in the same terminal biconnected component takes  $O(|E|)$ . *Case 4* is performed at most  $|V|$  times. Thus all the applications of *Case 1* and *Case 4* can be done in  $O(|V|^3)$ . *Case 2* or *Case 3* or *Case 5* is performed at most one time. For each of those three cases, we need to compute a perfect matching for some induced subgraphs of  $G$  (at most three subgraphs). Hence the overall complexity of our algorithm is  $O(|E| \cdot |V|^2)$ .  $\square$

## 7 | GRAPHS WITH FIXED BOUNDED TREEWIDTH

It is shown in [3] that the graph property of having a matching-cut can be expressed in MSOL. All graph properties definable in MSOL can be decided in linear time for the classes of graphs with bounded treewidth, when a tree-decomposition is given. Hence it can be decided in polynomial-time if a graph of bounded treewidth (given a tree-decomposition) has a matching-cut. We refer to [7] for definitions and an overview of the logical language MSOL.

**Theorem 7.1.** *PERFECT MATCHING-CUT is polynomial-time solvable for graphs of bounded treewidth.*

*Proof.* We show that the property of a graph  $G = (V, E)$  having a perfect matching-cut can be expressed in MSOL as follows:

$$\begin{aligned} & \exists V_1 \subseteq V : \exists V_2 \subseteq V : \exists M \subseteq E : (V_1 \cap V_2 = \emptyset) \wedge (V_1 \cup V_2 = V) \wedge \\ & \neg(V_1 = \emptyset) \wedge \neg(V_2 = \emptyset) \wedge \\ & (\forall u \in V : \exists v \in V : \forall w \in V : \neg(v = w) \wedge (uv \in M) \wedge \neg(uw \in M)) \wedge \\ & \neg(\exists u \in V_1 : \exists v \in V_2 : (uv \in E) \wedge \neg(uv \in M)). \end{aligned}$$

The first line defines a nontrivial partition  $(V_1, V_2)$  of the vertices of  $V$  and a set  $M$  of edges of  $E$ .

The second line expresses that every vertex must be an extremity of exactly one edge in  $M$ , that is,  $M$  must be a perfect matching.

The last line expresses that there is no vertex of  $u \in V_1$  with a neighbor in  $v \in V_2$  such that  $uv$  is not  $M$ , that is,  $E(V_1, V_2) \subseteq M$  and thus  $M$  contains a cut. So if such an  $M$  exists, then  $M$  is a perfect matching-cut.  $\square$

It is also shown in [3] that the graph property of having a matching-cut can be expressed in MSOL without *quantification over edge sets*. Any graph property expressible as MSOL without *quantification over edge sets* can be decided in linear time for classes of graphs with bounded cliquewidth (such as cographs), when a corresponding decomposition is given. We refer to [7] for additional details. Unfortunately, it has been proved in [7], Proposition 5.13, page 338, that the property of a graph having a perfect matching cannot be expressed in MSOL without quantification over edge sets. Hence we cannot conclude that it can be decided in polynomial-time if a graph of bounded cliquewidth (given a corresponding decomposition) has a perfect matching-cut using the associated MSOL definition.

## 8 | CONCLUSION AND OPEN PROBLEMS

With the same flavor as for MATCHING-CUT, we proved complexity results for PERFECT MATCHING-CUT under several parameter restrictions and for graph subclasses.

- *Regular graphs*: PERFECT MATCHING-CUT is NP-complete for 5-regular graphs even for bipartite graphs.
- *Diameter*: For  $d$  a fixed integer and  $G$  a graph with  $\text{diam}(G) = d$ , PERFECT MATCHING-CUT is polynomial-time solvable for  $d \leq 2$  and NP-complete for  $d \geq 3$ ; when  $G$  is bipartite PERFECT MATCHING-CUT is polynomial-time solvable for  $d \leq 3$  and NP-complete for  $d \geq 4$ .
- *Planar graphs*: PERFECT MATCHING-CUT is NP-complete for graphs with  $\delta(G) = 3$ ,  $\Delta(G) = 4$ , and for graphs with girth  $g(G) = 5$ , but is polynomial-time solvable for cubic planar graphs.
- PERFECT MATCHING-CUT is polynomial-time solvable for claw-free graphs and NP-complete for  $K_{1,4}$ -free planar graphs.
- PERFECT MATCHING-CUT is polynomial-time solvable for  $P_5$ -free graphs.
- *Bounded treewidth*: PERFECT MATCHING-CUT is polynomial.

We give a list of open problems that seem relevant after the results we proved above.

- cubic (nonplanar) graphs, subcubic graphs, 4-regular planar graphs;
- bipartite planar graphs;
- planar graphs with girth  $g(G) = d$  for fixed  $d \geq 6$ ;
- $P_k$ -free graphs for  $k \geq 6$ .

## ACKNOWLEDGMENTS

The authors express their gratitude to François Delbot and Stéphane Rovedakis for helpful discussions. The authors are grateful to the anonymous referees for their useful comments, corrections, and improvements.

## ORCID

Valentin Bouquet  <http://orcid.org/0000-0003-4681-5910>

## REFERENCES

1. G. Bacsó and Z. Tuza, *Dominating cliques in  $P_5$ -free graphs*, Period. Math. Hungar. **21** (1990), 303–308.
2. J. A. Bondy and U. S. R. Murty, *Graph theory*, Springer, London, 2008.
3. P. Bonsma, *The complexity of the matching-cut problem for planar graphs and other graphs classes*, J. Graph Theory. **62** (2009), 109–126.
4. P. Bonsma, A. M. Farley, and A. Proskurowski, *Extremal graphs having no matching cuts*, J. Graph Theory. **69** (2012), 206–222.
5. E. Camby and O. Schaudt, *A new characterization of  $P_k$ -free graphs*, Algorithmica. **75** (2016), 205–217.
6. V. Chvátal, *Recognizing decomposable graphs*, J. Graph Theory. **8** (1984), 51–53.
7. B. Courcelle and J. Engelfriet, *Graph structure and monadic second-order logic*, Cambridge University Press, Cambridge, 2012.
8. A. A. Diwan, *Disconnected 2-factors in planar cubic bridgeless graphs*, J. Combin. Theory Ser. B. **84** (2002), 249–259.
9. P. Heggernes and J. A. Telle, *Partitioning graphs into generalized dominating sets*, Nordic J. Comput. **5** (1998), no. 2, 128–142.
10. V. B. Le and J. A. Telle, *The perfect matching cut problem revisited*, Proc. WG. **12911** (2021), 182–194.
11. F. Lucke, D. Paulusma, and R. Bernard, *Finding matching cuts in  $H$ -free graphs*, 33rd International Symposium on Algorithms and Computation (ISAAC 2022), vol. **248**, no. 2, 2022, pp. 1–16.
12. J. E. Hopcroft and R. M. Karp, *An  $n^{5/2}$  algorithm for maximum matchings in bipartite graphs*, SIAM J. Comput. **2** (1973), 225–231.
13. H. Le and V. B. Le, *A complexity dichotomy for matching-cut in (bipartite) graphs of fixed diameter*, Theoret. Comput. Sci. **770** (2019), 69–78.
14. V. B. Le and B. Randerath, *On stable cutsets in line graphs*, Theoret. Comput. Sci. **301** (2003), 463–475.
15. A. Moshi, *Matching-cutsets in graphs*, J. Graph Theory. **13** (1989), 527–536.
16. D. P. Sumner, *Graphs with 1-factor*, Proc. Amer. Math. Soc. **42** (1974), 8–12.

**How to cite this article:** V. Bouquet, and C. Picouleau, *The complexity of the perfect matching-cut problem*, J. Graph Theory. (2024), 1–31. <https://doi.org/10.1002/jgt.23167>