



HAL
open science

Effect of the hysteretic response of elastomers on the fatigue life

Andri Andriyana, Erwan Verron

► **To cite this version:**

Andri Andriyana, Erwan Verron. Effect of the hysteretic response of elastomers on the fatigue life. Fourth European Conference on Constitutive Models for Rubber, ECCMR 2005, Jun 2005, Stockholm, Sweden. pp.31-36, 10.1201/9781315140216-6 . hal-04722680

HAL Id: hal-04722680

<https://hal.science/hal-04722680v1>

Submitted on 7 Oct 2024

HAL is a multi-disciplinary open access archive for the deposit and dissemination of scientific research documents, whether they are published or not. The documents may come from teaching and research institutions in France or abroad, or from public or private research centers.

L'archive ouverte pluridisciplinaire **HAL**, est destinée au dépôt et à la diffusion de documents scientifiques de niveau recherche, publiés ou non, émanant des établissements d'enseignement et de recherche français ou étrangers, des laboratoires publics ou privés.



Distributed under a Creative Commons Attribution - NonCommercial 4.0 International License

Effect of the hysteretic response of elastomers on the fatigue life

A. Andriyana & E. Verron

*Institut de Recherche en Génie Civil et Mécanique
Ecole Centrale de Nantes, France*

ABSTRACT: Elastomers are widely used in automotive Anti-Vibration Systems (AVS). In this application, elastomeric parts are subjected to cyclic loading condition which lead to fatigue failure. Number of experimental investigations show that elastomeric materials exhibit stress-softening and hysteresis in these conditions. Numerous models have been proposed to capture the corresponding mechanical response but few attempts focus on the relationship between cyclic behavior and fatigue life prediction maybe due to the complex nature of phenomena. In this study, the qualitative relationship between hysteretic response and fatigue life prediction of elastomers is considered. A simple non-linear phenomenological three-parameter model is adopted to simulate the long-term (stabilized) hysteretic response of the material under uniaxial cyclic loading. In order to estimate fatigue life, only crack initiation is considered and the concept of configurational stress is adopted to define the end of life. Different stretch-controlled loading conditions are considered, i.e. the influence of both mean stretch and stretch amplitude is investigated in order to build the Haigh diagram. Thus, the effect of hysteretic response of elastomers on the fatigue life is discussed. The emphasis is laid on the prediction of the well-known reinforcement phenomenon classically observed for tension-tension loading conditions.

1 INTRODUCTION

The last decade has experienced a major advance in the development of finite element based tools for the simulation of a wide range of industrial parts. This is mainly motivated by the need to improve time and cost efficiency in a highly competitive industry particularly in automotive AVS industry. While the basic concept of finite element method has been well established, the choice of material constitutive relations and the computer running time issues remain an ongoing study.

Elastomers are widely used in automotive AVS. Many studies regarding this material have been conducted. Among these studies, estimation of fatigue life seems fascinate many authors. Several fatigue criteria can easily be found in literature; see for example Mars & Fatemi (2002) or very recently Verron et al. (2004). It is well known that fatigue life of elastomers increases with mean stress for a given stress amplitude (Abraham et al. 2005 and André et al. 1999). This reinforcement phenomenon is often imputed to strain-induced crystallization (André et al. 1999 and Cadwell et al. 1940).

Under cyclic loading conditions, elastomers exhibit stress softening and hysteresis. It is believed that viscoelasticity and viscoplasticity are the main reason for the hysteretic response (Drozdov & Dorfmann 2001, Miehe & Keck 2000, Bergström & Boyce 1998, Spathis 1997 and Lion 1996). However, it is experimentally

shown by Chagnon (2003) that hysteresis of elastomers is quasi-rate independent. A very interesting result was obtained by Toki et al. (2000) and Trabelsi et al. (2003) who related hysteresis with strain-induced crystallization. Authors compared the hysteretic response of elastomers and the real time evolution of crystallization during stretching and retracting. It has opened a new horizon on the study of the relationship among hysteresis, strain-induced crystallization and fatigue life.

The purpose of this study is to show theoretically that the reinforcement phenomenon of elastomers can be predicted using a simple non linear three-parameter model and an appropriate fatigue life criterion. In Section 2, a general derivation of constitutive equations for a simple non-linear phenomenological three-parameter model is presented in order to simulate a stabilized hysteretic response. The fatigue life criterion proposed by Verron et al. (2004) is adopted and briefly recalled in Section 3. Here the end of life is defined by the initiation of a crack estimated using the so-called configurational stress concept. Results and discussion are given in Section 4.

2 CONSTITUTIVE EQUATIONS

In order to derive the constitutive relations, consider a stress-stretch curve of carbon black-filled natural

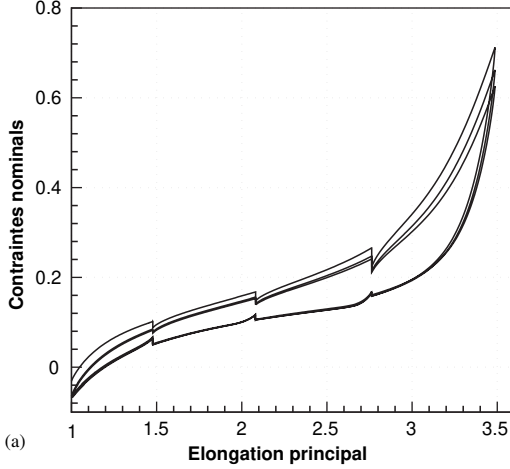

Figure 1. Uniaxial cyclic tension test interrupted by relaxation steps.

rubber as shown in Figure 1 (presented in the first Piola-Kirchoff stress against stretch). This curve was obtained from uniaxial cyclic test interrupted by relaxation steps at different stretching levels (Chagnon 2003).

It can be seen that natural rubber exhibits a significant hysteresis. During relaxation, the stress decreases in stretching and increases in retracting, approaching the so-called equilibrium configuration, i.e. a configuration that can virtually be reached by a sufficiently long-time stress relaxation test. Similar observations were also obtained by Bergström & Boyce (1998) and Lion (1996). This hysteretic response has been interpreted as a consequence of viscoelastic or viscoplastic nature of elastomers. Thus many models proposed in the literature were developed using this interpretation (Drozdov & Dorfmann 2001, Bergström & Boyce 2000, Lion 1996). However, several microscopic observations showed that hysteresis can also be imputed to strain-induced crystallization (Trabelsi et al. 2003 and Toki et al. 2000).

In this study hysteresis is modeled by a simple non-linear phenomenological viscoelastic three-parameter model. This model is obtained by combining the viscoelastic-generalized Maxwell element network (B) in parallel with a non-linear spring network (A) as presented in Figure 2.

A proper and complete derivation of constitutive relations for this model in the frame of visco-hyperelasticity has been conducted by Huber & Tsakmakis (2000). Elastomers are assumed to be isotropic and incompressible. The total deformation gradient tensor \mathbf{F} acts on both networks A and B, i.e.

$$\mathbf{F} = \mathbf{F}_A = \mathbf{F}_B \quad (1)$$

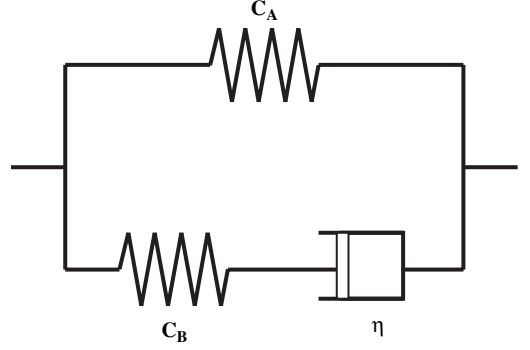

Figure 2. Three-parameter model.

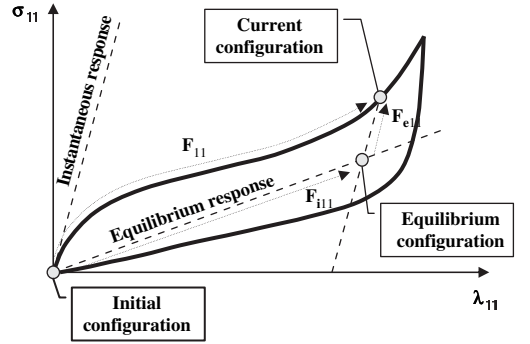

Figure 3. Equilibrium configuration.

The deformation gradient tensor on network B can further be decomposed into elastic and inelastic parts through a tensor product:

$$\mathbf{F}_B = \mathbf{F}_e \mathbf{F}_i \quad (2)$$

where \mathbf{F}_i represents a configuration obtained by a virtual elastic infinitely fast unloading of network B from the current configuration to an equilibrium configuration which is not a stress-free configuration (Huber & Tsakmakis 2000). See Figure 3 for the illustration. The left Cauchy-Green strain tensor \mathbf{B} and its elastic part \mathbf{B}_e are:

$$\mathbf{B} = \mathbf{F}\mathbf{F}^T \quad (3)$$

$$\mathbf{B}_e = \mathbf{F}_e \mathbf{F}_e^T \quad (4)$$

By considering an isothermal process, the second law of thermodynamics can be expressed in the form:

$$\boldsymbol{\sigma} : \mathbf{D} - \dot{W} = \mathbf{T}_E : \hat{\Gamma} - \dot{W} \geq 0 \quad (5)$$

where W is the strain energy density per unit volume of the reference configuration, \mathbf{D} is the Eulerian

deformation rate tensor, i.e. the symmetric part of the velocity gradient tensor \mathbf{L} . $\hat{\mathbf{\Gamma}}$ is the deformation rate tensor at the intermediate configuration, and \mathbf{T}_E is the extra part of the stress tensor at the intermediate configuration. These tensors are defined by:

$$\mathbf{D} = \frac{1}{2} (\mathbf{L} + \mathbf{L}^T) \quad (6)$$

$$\hat{\mathbf{\Gamma}} = \mathbf{F}_e^T \dot{\mathbf{D}} \mathbf{F}_e \quad (7)$$

$$\mathbf{T} = -p \mathbf{C}_e^{-1} + \mathbf{T}_E \quad (8)$$

where p is an arbitrary hydrostatic pressure which can be determined using equilibrium equations. \mathbf{C}_e is the elastic part of the right Cauchy-Green strain tensor. Furthermore, we assume that W can be written as a function of the first invariants of \mathbf{B} and \mathbf{B}_e :

$$W(I_1, I_1^e) = W_1(I_1) + W_2(I_1^e) \quad (9)$$

$$I_1 = \text{tr}[\mathbf{B}], \quad I_1^e = \text{tr}[\mathbf{B}_e] \quad (10)$$

It can be shown that expression of the second law of thermodynamics (5) becomes:

$$\begin{aligned} \mathbf{F}_e^{-1} \left(\boldsymbol{\sigma}_E - 2 \frac{\partial W_1}{\partial I_1} \mathbf{B} - 2 \frac{\partial W_2}{\partial I_1^e} \mathbf{B}_e \right) \mathbf{F}_e^{-T} : \hat{\mathbf{\Gamma}} \\ + \mathbf{F}_e^T \left(\boldsymbol{\sigma}_E - 2 \frac{\partial W_1}{\partial I_1} \mathbf{B} \right) \mathbf{F}_e^{-T} : \mathbf{D}_i \geq 0 \end{aligned} \quad (11)$$

where \mathbf{D}_i is the inelastic part of the Eulerian deformation rate tensor and $\boldsymbol{\sigma}_E$ is the deviatoric part of the Cauchy stress tensor defined by:

$$\mathbf{D}_i = \frac{1}{2} (\mathbf{L}_i + \mathbf{L}_i^T) \quad (12)$$

$$\boldsymbol{\sigma} = -p \mathbf{I} + \boldsymbol{\sigma}_E \quad (13)$$

in which p is an arbitrary hydrostatic pressure and \mathbf{I} is the identity tensor.

Following the argument of Coleman & Gurtin (1967), we have:

$$\boldsymbol{\sigma} = -p \mathbf{I} + 2 \left(\frac{\partial W_1}{\partial I_1} \mathbf{B} + \frac{\partial W_2}{\partial I_1^e} \mathbf{B}_e \right) \quad (14)$$

and the simplest sufficient condition to fulfill inequality (11) is:

$$\mathbf{D}_i = \frac{1}{\eta} \left[\mathbf{F}_e^T \left(\boldsymbol{\sigma}_E - 2 \frac{\partial W_1}{\partial I_1} \mathbf{B} \right) \mathbf{F}_e^{-T} \right]_{\text{dev}} \quad (15)$$

where the index dev represents the deviatoric part.

3 FATIGUE LIFE CRITERION

3.1 Brief literature study

In general, there are two approaches in estimating fatigue life of elastomers: crack initiation (nucleation) and crack growth approaches. For our purpose, we will only briefly recall the former. The latter which adopted the famous definition of the Griffith energy release rate is well documented in Mars & Fatemi (2002) and the references herein.

The crack initiation approach considers that fatigue life of rubber can be determined from the history of strain and stress at a point in the body. Two most widely used criteria are the maximum principal stretch and the strain energy density. However both fail to give satisfying predictions for multiaxial problems. Later on, it is considered that nucleation involves small intrinsic flaws which can be seen as small cracks that grow upon loading. This led to the definition of the cracking energy density by Mars (2001). This energy represents the part of total energy which contributes to the growth of these small cracks. The fatigue life is then defined by the number of cycles required to create a crack at a certain size.

Very recently, Verron et al. (2004) used the configurational stress concept to define end of life. This was motivated by the fact that crack nucleation criteria should be formulated in terms of continuum mechanics in order to be combined with the finite element modeling in engineering applications. The concept was firstly introduced by Eshelby (1951) through the energy momentum tensor (Eshelby tensor) which was used to study forces on elastic singularities and defects. This tensor was extended to large strain by Eshelby (1975) and Chadwick (1975). Further studies were then performed by several authors, see for example the works of Kienzler & Herrmann (2000), Gurtin (2000) and Maugin (1993). For our purpose, we will adopt the criterion developed by Verron et al. (2004). A brief formulation of this criterion is presented in the following.

3.2 Configurational stress concept

Consider a rubber body and a current particle M in the reference configuration of the physical space. In the material space, the body is subjected to a continuous distributed defect density. Enlarging vicinity of M leads to Figure 4. The defect is represented by a grey disk, \mathbf{N} is the outward normal vector of an unit surface and $\boldsymbol{\alpha}$ is an arbitrary given direction.

The Eshelby tensor in M relative to the reference configuration is defined by:

$$\boldsymbol{\Sigma} = W \mathbf{I} - \mathbf{F}^T \boldsymbol{\Pi} \quad (16)$$

where $\boldsymbol{\Pi}$ is the first Piola-Kirchoff stress tensor. The other quantities were introduced in Section 2. The unit

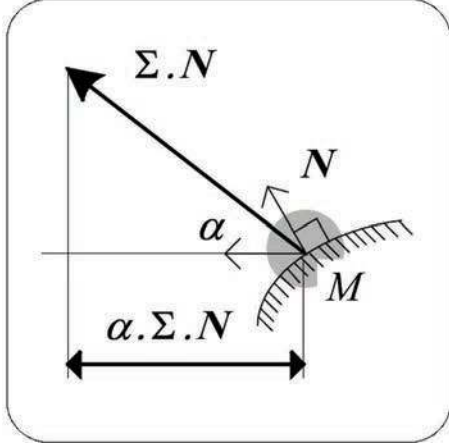

Figure 4. Material space.

surface on which the maximum energy is released is defined by its outward normal vector $\tilde{\mathbf{N}}$ such that:

$$\|\Sigma \cdot \mathbf{N}\| \text{ is maximum for } \mathbf{N} = \tilde{\mathbf{N}} \quad (17)$$

The Eshelby tensor is symmetric, thus it has three real eigenvalues, denoted by $(\Sigma_i)_{i=1,2,3}$ and three eigenvectors, denoted by $(\mathbf{V}_i)_{i=1,2,3}$:

$$\Sigma = \Sigma_i \mathbf{V}_i \otimes \mathbf{V}_i, \quad (18)$$

These three vectors correspond to the directions in which the energy release rates tend to open or close the void by material normal traction without material “shear” traction. Using the fact that the body tends to reduce its potential energy, Verron et al. (2004) showed that crack nucleation criterion for rubber can be written by:

$$\Sigma^* = \left| \min \left[(\Sigma_i)_{i=1,2,3}, 0 \right] \right| \quad (19)$$

Authors compared this criterion to three other criteria i.e. the maximum principal stretch, the strain energy density and the cracking energy density in the case of elasticity. Here we will enlarge the application of the criterion to the case of visco-hyperelasticity by considering only the effect of hysteretic response under cyclic loading.

One crucial problem to be solved in the case of visco-hyperelasticity is to separate the non-dissipative part of the Eshelby tensor which opens or closes the crack from its dissipative part. In this preliminary study, a procedure used for the case of plasticity by Cermelli et al. (2001) is adopted. In order to evaluate the non-dissipative part of the Eshelby tensor, it is

chosen to express the Eshelby tensor relative to the intermediate configuration associated with the elastic and inelastic decomposition in Eq. (2). Introducing the strain energy density relative to the intermediate configuration as:

$$W_{int} = J_i^{-1} W \quad (20)$$

and the relative first Piola-Kirchoff stress tensor as:

$$\Pi_{int} = J_i^{-1} \Pi F_i^T \quad (21)$$

it is considered that the non-dissipative part of the Eshelby tensor is given by:

$$\Sigma^{ND} = W_{int} \mathbf{I} - \mathbf{F}_e^T \Pi_{int} \quad (22)$$

where J_i is the determinant of the inelastic part of the deformation gradient tensor \mathbf{F}_i .

3.3 Hysteretic behavior

For the next calculation, we will adopt the Neo-Hookean constitutive equation. For our model it is given by:

$$W(I_1, I_1^e) = C_A(I_1 - 3) + C_B(I_1^e - 3) \quad (23)$$

where C_A and C_B are the model parameters.

For uniaxial cyclic loading, the only variable involved is the principal stretch in the stretching direction λ . The deformation tensors \mathbf{F} and \mathbf{F}_e have the form:

$$\mathbf{F} = \begin{pmatrix} \lambda & 0 & 0 \\ 0 & \frac{1}{\sqrt{\lambda}} & 0 \\ 0 & 0 & \frac{1}{\sqrt{\lambda}} \end{pmatrix} \quad \mathbf{F}_e = \begin{pmatrix} \lambda_e & 0 & 0 \\ 0 & \frac{1}{\sqrt{\lambda_e}} & 0 \\ 0 & 0 & \frac{1}{\sqrt{\lambda_e}} \end{pmatrix} \quad (24)$$

where λ_e is the elastic stretch.

During a cycle (stretching and retracting), we have to accumulate the increment of the non-dissipative part of the Eshelby tensor especially the contribution which tends to open the crack i.e. the negative part of Σ^{ND} . Using this argument, Eq. (19) can be changed to:

$$\Sigma^* = \left| \int_{\text{cycle}} \min(d\Sigma_{11}^{ND}, 0) \right|, \quad (25)$$

with:

$$\begin{aligned} d\Sigma_{11}^{ND} &= \frac{\partial \Sigma_{11}^{ND}}{\partial \lambda} d\lambda = 2C_A \left(-\lambda - \frac{2}{\lambda^2} \right) d\lambda \\ &+ 2C_B \left(-\lambda_e - \frac{2}{\lambda_e^2} \right) \frac{1}{\lambda_i} \left(1 - \frac{\lambda \lambda_i}{\lambda \lambda_i} \right) d\lambda \end{aligned} \quad (26)$$

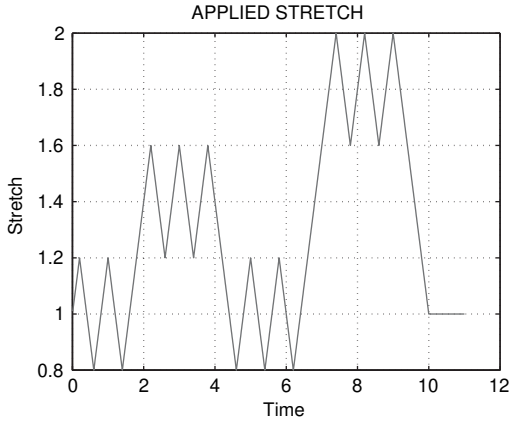

Figure 5. Applied stretch.

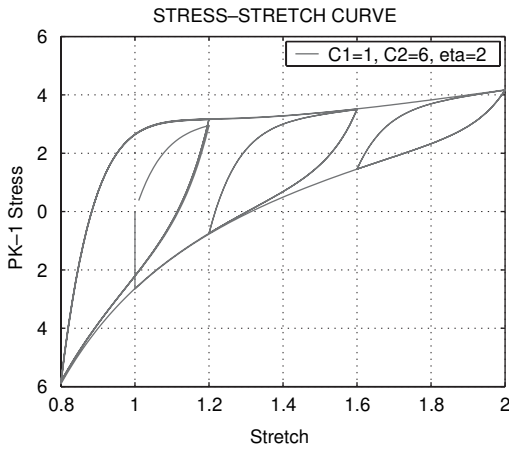

Figure 6. Model response.

4 RESULTS AND DISCUSSION

In order to build the Haigh diagram, different stretch-controlled loading conditions are considered i.e. different mean stretch and stretch amplitude. Let $C_A = 1$ MPa, $C_B = 6$ MPa, $\eta = 2$ MPa.s and $\lambda = 1$ s⁻¹. These values are chosen to obtain a stabilized hysteretic response and will be used for the rest of our calculation.

The cyclic loading is applied to the model as shown in Figure 5. The stretch amplitude is fixed at 0.2 while the mean stretch is varied; 1, 1.4 and 1.8. The model response is presented in Figure 6 in terms of the nominal stress (the first Piola-Kirchoff).

It can be seen that the hysteretic loop area decreases as the mean stretch increases for a given stretch amplitude. At the end of the loading sequence, a relaxation phenomenon of the model response is observed. Similar

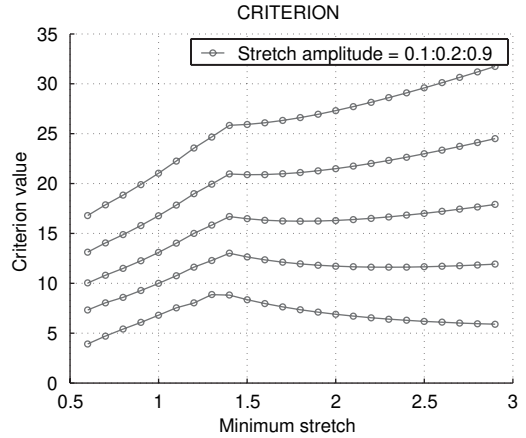

Figure 7. Criterion value.

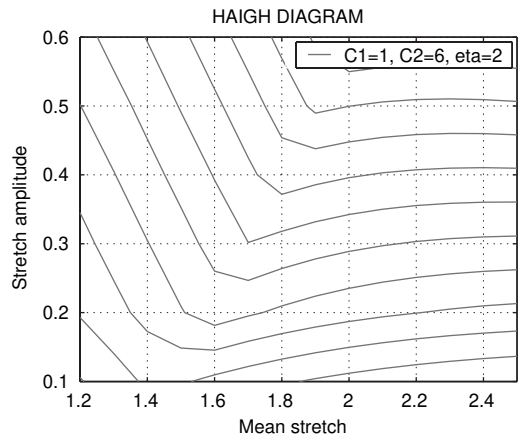

Figure 8. Haigh diagram.

results were experimentally observed by Abraham et al. (2005) and Lion (1996). Figure 7 shows variation of the criterion as a function of minimum stretch. The five curves from the bottom to the top represent stretch amplitudes equal to 0.1, 0.3, 0.5, 0.7 and 0.9. The minimum stretch equal to 1 represents the case where the applied stretching is followed by a complete retracting to the undeformed configuration. We observe that the model response exhibits reinforcement phenomenon. The criterion value increases until a certain limit of minimum stretch is reached before it decreases with the increase of minimum stretch. This limit (minimum stretch) is likely independent of the stretch amplitude. Note that if this limit is expressed in terms of the mean stretch, then this limit is highly dependent on the stretch amplitude.

Finally the Haigh diagram (in terms of stretch) of this model is presented in Figure 8. It is obvious that

the model can exhibit significant reinforcement phenomenon. However the curve slope in the reinforcement area is lower than that obtained experimentally (see for example André et al. 1999). This is probably due to the strain energy density considered here. One interesting observation is the fact that the end of life increases when the hysteretic loop decreases. As mentioned in Introduction, it will be interesting to study relationship among reinforcement, hysteresis and strain-induced crystallization.

To close this paper, it is to note that the choice of the formulation of the Eshelby tensor for a viscoelastic material is of major importance. Here we consider the Eshelby tensor defined in the intermediate configuration. Nevertheless, as the decomposition $\mathbf{F}_e \mathbf{F}_i$ is not unique, further investigations are necessary to determine the most relevant formulation.

REFERENCES

- Abraham, F., Alshuth, T. & Jerrams, S. (2005). The effect of minimum stress and stress amplitude on the fatigue life of non strain crystallising elastomers. *Mat. Design* 26, 239–245.
- André, N., Cailletaud, G. & Piques, R. (1999). Haigh diagram for fatigue crack initiation prediction of natural rubber components. *Kautsch. Gummi Kunstst.* 52, 120–123.
- Bergström, J. S. & Boyce, M. C. (1998). Constitutive modeling of the large strain time-dependent behavior of elastomers. *J. Mech. Phys. Solids* 46(5), 931–954.
- Bergström, J. S. & Boyce, M. C. (2000). Large strain time-dependent behavior of filled elastomers. *Mech. Mater.* 32, 627–644.
- Cadwell, M., Merrill, R., Sloman, C. & Yost, F. (1940). Dynamic fatigue life of rubber. *Industrial and Engineering Chemistry* 12(1), 19–23.
- Cermelli, P., Fried, E., & Sellers, S. (2001). Configurational stress, yield and flow in rate-independent plasticity. *Proc. R. Soc. Lond.* 457, 1447–1467.
- Chadwick, P. (1975). Applications of an energy-momentum tensor in non-linear elastostatics. *J. Elast.* 5(3–4), 249–258.
- Chagnon, G. (2003). *Modélisation de l'effet Mullins dans les élastomères* Ph. D. thesis, Ecole Centrale de Nantes, France.
- Coleman, B. & Gurtin, M. (1967). Thermodynamics with internal state variables. *Chemical Physics* 47(2), 597–613.
- Drozdo, A. D. & Dorfmann, A. I. (2001). Stress-strain relations in finite viscoelastoplasticity of rigid-rod networks: applications to the Mullins effect. *Continuum Mech. Thermodyn.* 13, 183–205.
- Eshelby, J. D. (1951). The force on an elastic singularity. *Phil. Trans. R. Soc. Lond. A.* 244, 87–112.
- Eshelby, J. D. (1975). The elastic energy-momentum tensor. *J. Elast.* 5(3–4), 321–335.
- Gurtin, M. E. (2000). *Configurational Forces as Basic Concept of Continuum Physics*. Berlin: Springer.
- Huber, N. & Tsakmakis, C. (2000). Finite deformation viscoelasticity laws. *Mech. Mat.* 32, 1–18.
- Kienzler, R. & Herrmann, G. (2000). *Mechanics in Material Space*. Berlin: Springer.
- Lion, A. (1996). A constitutive model for carbon black filled rubber: experimental investigations and mathematical representation. *Continuum Mech. Thermodyn.* 8, 153–169.
- Mars, W. V. (2001, August). *Multiaxial fatigue of rubber*. Ph.D. thesis, University of Toledo.
- Mars, W. V. & Fatemi, A. (2002). A literature survey on fatigue analysis approaches for rubber. *Int. J. Fatigue* 24, 949–961.
- Maugin, G. A. (1993). *Material Inhomogeneities in Elasticity*. London: Chapman and Hall.
- Miehe, C. & Keck, J. (2000). Superimposed finite elastic-viscoelastic-plastoelastic stress response with damage in filled rubbery polymers. Experiments, modelling and algorithmic implementation. *J. Mech. Phys. Solids* 48, 323–365.
- Spathis, G. (1997). Non-linear constitutive equations for viscoelastic behaviour of elastomers at large deformations. *Polym. Gels Networks* 5, 55–68.
- Toki, S., Fujimaki, T. & Okuyama, M. (2000). Strain-induced crystallization of natural rubber as detected real-time by wide-angle x-ray diffraction technique. *Polymer* 41, 5423–5429.
- Trabelsi, S., Albouy, P. & Rault, J. (2003). Crystallization and melting processes in vulcanized stretched natural rubber. *Macromolecules* 36(20), 7624–7639.
- Verron, E., Le-Cam, J. B. & Gornet, L. (2004). A multi-axial criterion for crack nucleation in rubber. *Mech. Res. Commun. (accepted)*.