



HAL
open science

A Long Range Fuel Cell/Soaring UAV System for Crossing the Atlantic Ocean

Nikola Gavrilovic, David Vincekovic, Jean-Marc Moschetta

► **To cite this version:**

Nikola Gavrilovic, David Vincekovic, Jean-Marc Moschetta. A Long Range Fuel Cell/Soaring UAV System for Crossing the Atlantic Ocean. 11th International Micro Air Vehicle Competition and Conference, Sep 2019, Madrid, Spain. <hal-04722393>

HAL Id: hal-04722393

<https://hal.science/hal-04722393v1>

Submitted on 22 Oct 2024

HAL is a multi-disciplinary open access archive for the deposit and dissemination of scientific research documents, whether they are published or not. The documents may come from teaching and research institutions in France or abroad, or from public or private research centers.

L'archive ouverte pluridisciplinaire HAL, est destinée au dépôt et à la diffusion de documents scientifiques de niveau recherche, publiés ou non, émanant des établissements d'enseignement et de recherche français ou étrangers, des laboratoires publics ou privés.



HAL Authorization

A Long Range Fuel Cell/Soaring UAV System for Crossing the Atlantic Ocean

N. Gavrilović*, D. Vinceković†, and J-M Moschetta‡
 ISAE-SUPAERO, Université de Toulouse, 31400 Toulouse, France

ABSTRACT

The design of a long-range unmanned aircraft system powered by fuel cells is investigated, with the study focusing on the feasibility of crossing the Atlantic Ocean. The motivation behind this aircraft is to demonstrate the capability of hydrogen fuel cells as an alternative fuel source and to create a case for future commercial and civilian aircraft. Existing hydrogen powered UAS are benchmarked and an in-depth analysis of the mission environment is conducted to ultimately determine reasonable requirements for the aircraft. The requirements of a 3000 km range, a maximum mass of 25 kg and being primarily powered by fuel cells, are used as inputs for the conceptual design phase. A classical design approach is conducted but modified appropriately for a fuel cell powered UAS. The aircraft mass, lift-to-drag ratio, wing loading and thrust-to-weight ratio are iterated until a baseline configuration that can feasibly cross the Atlantic Ocean is achieved. Some additional aspects oriented towards exploitation of atmospheric phenomena in the purpose of performance improvement will also be exposed.

1 INTRODUCTION

Unmanned aircraft systems (UAS) have become instrumental tools for missions in various military, civil and commercial fields. Current generation electrical powered unmanned aircraft systems are limited in terms of range and endurance due to the low energy density of their lithium-based batteries. However, many UAS applications require high range and endurance capabilities for intelligence, surveillance and reconnaissance. This demand for flights which last for considerable periods of time without the need to frequently land coupled with efforts to minimize environmental impact and the benefits of a low thermal and noise signature, make long range electrical aircraft desirable. An emerging source of electrical energy with the potential to solve the limitations of batteries is hydrogen fuel cells. They offer compelling

value for unmanned aircraft systems due to the ability to provide approximately five times more power per flight hour for the same weight as lithium based batteries, as well as offering improved reliability and reduced maintenance when compared to small internal combustion engines.

This project aims to analyze the feasibility of an unmanned aircraft system powered by hydrogen fuel cells that has the capability of crossing the Atlantic Ocean, as detailed in Figure 1. This route has been selected as it has historical significance; it was used by the French aviation company, "Aéropostale" in the 1930's and to date has only been crossed by UAS powered with internal combustion engines. The objectives of this project are to design a long range UAS featuring hydrogen fuel cell based propulsion, capable of flying from Dakar to Natal and being sufficiently light-weight to be within the certification category allowing beyond line of visual sight.



Figure 1: Route from Dakar to Natal 3000 km. Source: Google Maps, 2019.

2 STATE OF THE ART

Hydrogen fuel cells generate energy through catalysis; a process that separates the electrons and protons of the reactant fuel and forces the electrons to travel through a circuit which generates an electric current as explained by Gundlach [1]. Another catalytic process then takes the electrons and combines them back with protons and oxygen from the ambient air to form water as a waste product. It is seen that a fuel cell resembles a battery because it provides a direct electrical current, however, it uses a separate fuel and oxidant that are not stored together. According to Osenar et al. [2] this makes a

*Postdoctoral researcher, Department of Aerodynamics and Propulsion (Email address: nikola.gavrilovic@isae.fr)

†Graduate student

‡Full Professor, Department of Aerodynamics and Propulsion

fuel cell system inherently safer than other advanced high energy density battery technologies. The fuel cell itself is a way to convert the fuel and oxidant but does not store any energy. In general, because air is used as the oxidant and not stored with the fuel, the energy density of the fuel system is able to exceed traditional battery systems. Additionally, this allows of the system to be scaled up easier, as only larger hydrogen fuel tanks need to be installed and not a larger fuel cell. In comparison, to increase the range of a battery powered UAS, additional batteries will need to be added which significantly increases the mass. The high electrochemical conversion efficiency of fuel cells combined with the high specific energy of H₂ fuel makes them suited to extending the endurance of small UAS.

A state of the art evaluation of existing unmanned aircraft systems revealed several hydrogen fuel cell powered UAS which have been successfully designed and built. It also serves as a means to benchmark the project's objectives to a reasonable standard, ensuring a feasible project with worthwhile applications.

2.1 Sparkle Tech: Eagle Plus

The Eagle Plus is a small, VTOL, unmanned aircraft system built by Sparkle Tech based in Hong Kong and is shown in Figure 2. This UAS is a new generation hybrid fixed wing and multi-rotor configuration which allows it to be versatile due to not requiring a runway and also have high endurance as the cruise phase occurs with the fixed wing. The length of the UAS is approximately 2m with the airframe made from composite carbon fibre. The Eagle Plus has a 3.5 m wingspan, a wing area of 0.7 m² and its maximum take off mass is 21 kg. It utilizes a 500 W electric engine that is powered by a 9L liquid hydrogen fuel cell and also is equipped with a 10000mAh lithium polymer battery as a redundancy for flight safety. The total weight of the fuel tank, battery and equipment is 10 kg, which enables an endurance of 5 hours at a cruise speed of 28 m/s.

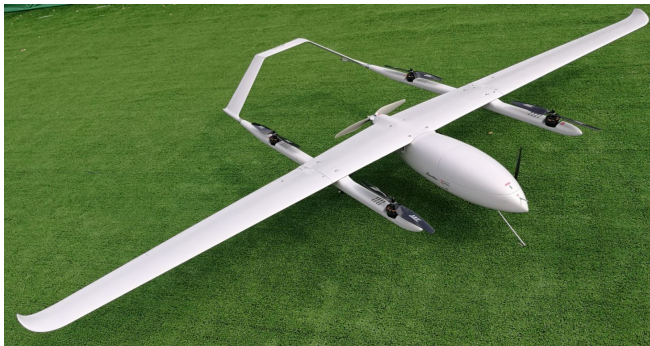

Figure 2: Eagle Plus VTOL UAS. Source: Sparkle Tech [3].

2.2 US Naval Research Laboratory: Ion Tiger

The United States Naval Research Laboratory's Ion Tiger features a conventional wing and stabilizer layout, as shown in Figure 3. The cruise velocity for the Ion Tiger is 13.9 m/s, features a wingspan of 5.2 m, a wing area of 1.57 m² and has a length of 2.4 m. The maximum take off mass of Ion Tiger is 16.1 kg, with a structural mass percentage of approximately 44% and cruise power of 300 W. The energy is provided by 550 W hydrogen fuel cells, stored at a pressure of 34.5 MPa. The Ion Tiger accomplished a 26 hour flight with a payload mass of 2.5 kg.



Figure 3: Ion Tiger UAS. Source: Swider-Lyons et al. [4].

2.3 H3 Dynamics: Hywings

The Hywings UAS, as shown in Figure 4, is developed by H3 Dynamics based in Singapore. It features a similar conventional wing and stabilizer layout to the Ion Tiger and has the same cruise velocity of 13.9 m/s. The maximum take off mass of Hywings is 7 kg and it features a 200 W hydrogen fuel cell system, pressurized between 30 and 35 MPa, that allows for quick hydrogen bottle refuelling. The UAS does not require a runway and can take-off via a hand launch and can achieve a range of up to 500 km and an endurance of up to 10 hours.

2.4 Insitu: Scan Eagle

Scan Eagle is developed by Insitu, a subsidiary of Boeing, and is a small, long-endurance, low-altitude UAS that is used for reconnaissance. The original variant as shown in Figure 5, is powered by a petrol engine, however, there are currently efforts to incorporate a hydrogen fuel cell power system to drive the UAS. As the 1200 W fuel cell module fits within the existing airframe without modification, the Scan Eagle fuel cell variant aims to be a technology demonstrator with a flight time of 9 hours. The UAS maximum take off mass is 22 kg, with a length of 1.55 m and a wingspan of 3.11 m. In addition, it takes off using a runway independent launcher and lands via a hook recovery system so it does not



Figure 4: Hywings UAS. Source: H3 Dynamics [5].



Figure 5: Scan Eagle UAS. Source: Insitu [7].

require landing gear.

The main characteristics of these platforms are outlined in Table 1. The analyzed platforms all feature hydrogen fuel cell propulsion but were not limited to a specific mission. The

UAS	M (kg)	V (m/s)	b (m)	E (hr)
Eagle Plus	21	28	3.5	5
Ion Tiger	16	14	5.2	26
Hywings	7	14	1.9	10
Scan Eagle	22	25	3.1	9

Table 1: Summary of existing fixed-wing UAS powered by fuel cells.

following conclusions may be drawn from the above benchmarking analysis:

- All benchmarked hydrogen fuel cell powered aircraft have a mass between 5 kg and 25 kg, which puts them within the open UAS category under EASA's [6] classification.
- It is important to note that the leading aircraft configuration for this platform is a conventional wing design. It is also noticed that the multi-rotor configurations used with hydrogen fuel cells had significantly less range and endurance than the fixed wing configurations which is why they were not included in the state of the art.
- The endurance time varies significantly between platforms, with the Ion Tiger featuring the highest endurance. This shows that weight is not the only parameter important for endurance; it is inferred that wingspan contributes significantly as the Ion Tiger has the largest wingspan which in turn minimizes the induced drag due to the large aspect ratio.

3 MISSION SPECIFICATION AND EQUIPMENT

3.1 Aircraft Requirements

The main design requirements for the unmanned aircraft system will be presented in this chapter. The first range requirement has been selected as this is the distance between the two cities, Dakar and Natal and the mass requirement is highly desirable to minimize the required certification for beyond visual line of sight flight. The third requirement has been selected because the motivation of the aircraft is to demonstrate the capability of enormous energy density of hydrogen fuel cells.

- Must be able to cross the distance of 3000 km.
- To have a total mass of less than 25 kg.
- Must use hydrogen fuel cells as primary energy source.

3.2 Feasibility Analysis

The initial feasibility study of basic aircraft parameters for completion of a defined mission has been performed to verify the requirements presented earlier. The iteration process has been set with basic parameters shown in Table 2. The objective of the iteration process is to achieve convergence in the total mass of the aircraft while satisfying the chosen parameters. According to a chosen speed of flight, lift to drag ratio and available energy density needed for cruise related to a fixed distance, the program will try to converge towards a total mass of the aircraft.

This analysis has been primarily performed for two sources of energy of which the lithium-polymer batteries and fuel cells. The sources of energy have been characterized through a value of specific energy density where the highly efficient lithium-polymer batteries provide around 250 Wh/kg, according to Gatti [8], which is 4 times less than for fuel cells. The analysis has revealed that the convergence process cannot be achieved with the usage of lithium batteries for such a required distance. On the other hand, the energy

Varying parameter	Value
V (m/s)	23
L/D	30
Energy Density (Wh/kg)	1015
Equipment mass (kg)	1
Structural mass (%)	40
Fixed parameter	Value
Distance (km)	3000
Propeller efficiency	0.8
Motor efficiency	0.8
Converter efficiency	0.9
Battery return rate	0.9
Ration motor mass/power (g/W)	0.3

Table 2: Parameters of feasibility study.

density of fuel cells achieves a steady convergence with a total mass of 20 kg for a relatively high required lift-to-drag ratio. This analysis has brought a conclusion that such a distance cannot be crossed with the usage of even most efficient lithium batters, while on the other side, the usage of fuel cells makes the journey possible.

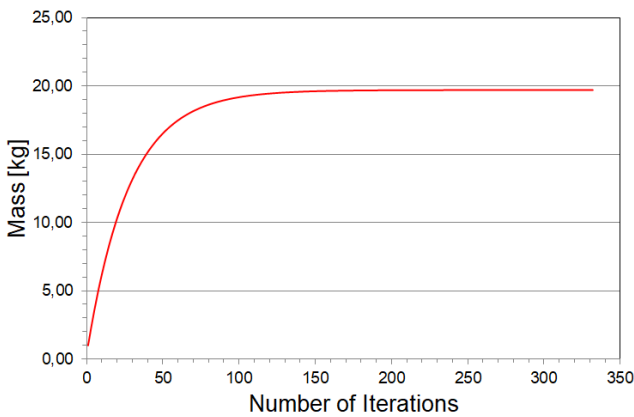

Figure 6: Mass convergence for chosen set of parameters presented in Table 2.

3.3 Fuel Cell Power System

Although there are nowadays several suppliers of modules and equipment related to the latest fuel cell technology, the present work is focused on products available from HES Energy Systems [9]. The specifications of the light weight commercially available Aerostak fuel cells (as an example shown in Figure 7) are summarized in Table 3, where the model number is the stack's rated power. Each fuel cell is cooled by an integrated fan and requires a hydrogen input pressure of 0.6 to 0.8 bar. Note that an additional 0.1 kg was considered for each fuel cell system specification for margin, as well as for the cylinder masses in Table 4.

Model	P (W)	Dimensions (mm)	M (kg)
Aerostak 250	300	110 x 120 x 124	0.83
Aerostak 500	600	194 x 105 x 166	1.4
Aerostak 1000 v1	1200	254 x 170 x 125	2.14
Aerostak 1000 v2	1300	194 x 127 x 193	1.9

Table 3: Summary of existing fixed-wing UAS powered by fuel cells.



Figure 7: Aerostak Fuel Cell. Source: HES Energy Systems [9].

The fuel cell model selected for the aircraft will be decided based on the conceptual design which will determine the required power. It is desirable to have the smallest possible fuel cell that can produce the required power as this will minimize the weight of the aircraft and improve the range capability. The hydrogen storage options are also to be provided by HES Energy Systems. The types of storage cylinders, shown in Figure 8, are summarized in Table 4, where their model number indicates the storage volume in liters.

Model	M (kg)	Energy (Wh)	D (mm)	L (mm)
A2	1.3	784	102	385
A2.5	1.35	980	132	288
A3.5	1.75	1372	132	375
A5	1.95	1960	152	395
A9	2.95	3528	173	528
A12	3.6	4704	196	532
A20	7.10	7840	230	655

Table 4: Summary of existing fixed-wing UAS powered by fuel cells.

3.4 Mission Environment

Due to the relatively low cruise speed and mass of the UAS, the wind's speed and direction can highly impact its performance. As the cruise phase will take place over the Atlantic Ocean, the wind conditions in this region have been examined using a tool called Windy. It compiles GFS and ECMWF wind models from the Swiss company Meteoblue



Figure 8: Hydrogen Cylinders. Source: HES Energy Systems [10].

and displays the wind conditions worldwide. Figure 9 shows the wind map for an average day in March at different altitudes, with the black line marking the mission route.

It is observed that the majority of the wind's direction over the aircraft's design route is favorable under an altitude of 1 km, with wind speeds varying between 3 and 10 m/s. While the wind has the potential to reduce the power requirements during cruise and increase the range of the aircraft, it is decided to not factor the benefits of the wind into the design. Despite the observed trend over this region of the Atlantic Ocean, the wind is still considered unreliable as its direction and speed will vary depending on the day. Therefore, the favorable wind will be considered as an external bonus but the aircraft will be designed such that it is capable of achieving its mission without assistance from the wind.

4 CONCEPTUAL DESIGN

The principal aim of the conceptual design phase is to determine the information required in order to decide whether the concept will be technically feasible and capable of meeting the design requirements. This process is primarily conducted using a classical conceptual design approach outlined by Raymer [11] and Roskam [12], but modified appropriately for a hydrogen fuel cell powered UAS. The expected outputs from this phase of the design are the aircraft mass, the required lift to drag ratio, the energy system requirements and a baseline geometric configuration.

4.1 Design Parameters

To determine the total aircraft mass, wing loading, thrust to weight ratio and aerodynamic requirements, an iterative procedure is used. The design flow, shown in Figure 10, illustrates the non-linear method, where the yellow icons rep-

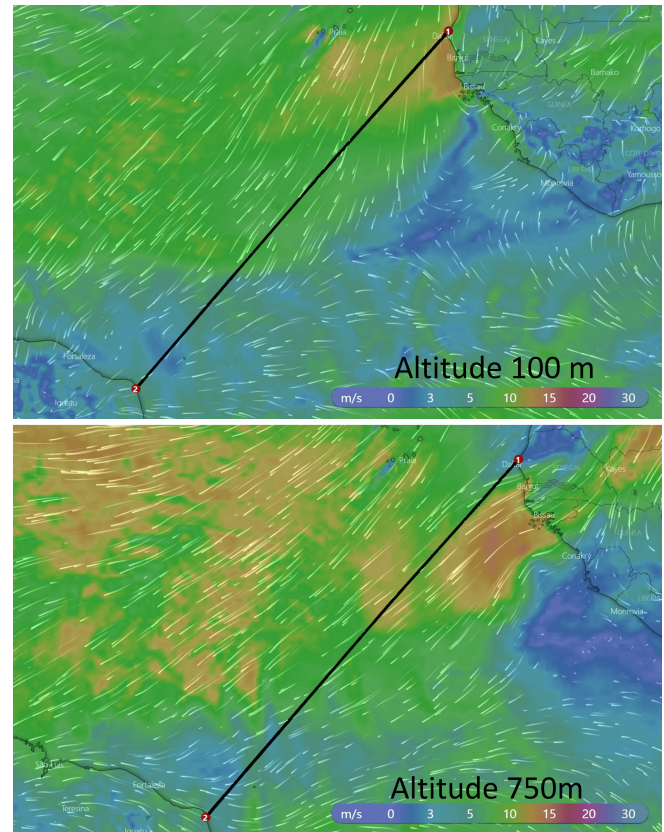

Figure 9: Wind direction at 100 and 750 m of altitude between Dakar in Senegal and Natal in Brazil.

resent inputs from the feasibility study of the aircraft and mission, the blue icons represent mass inputs that are iterable and the green icon represents the outputs which are the conceptual design parameters.

4.1.1 Geometric Parameter Summary

The Table 5 summarizes the geometric aircraft parameters which have been determined for the initial conceptual design. These parameters will be used throughout the conceptual design of the aircraft to establish a baseline configuration, however, will be adjusted appropriately to maximize the lift to drag ratio in the preliminary design. As an example, a slight dihedral angle has been applied for stability purposes. The parasite drag coefficient has been obtained through the ratio between the surface area of the aircraft that interacts with the flow and the planar area of the wings and equivalent skin friction drag coefficient. For a light aircraft, the equivalent skin friction drag is estimated to be $C_f = 0.004$ according to Raymer [11] and the wetted area ratio is estimated from initial models of the unmanned aircraft to be approximately 3.7. It is observed from Figure 11 that a lift to drag ratio of approximately 30 is common for powered sailplanes with as-

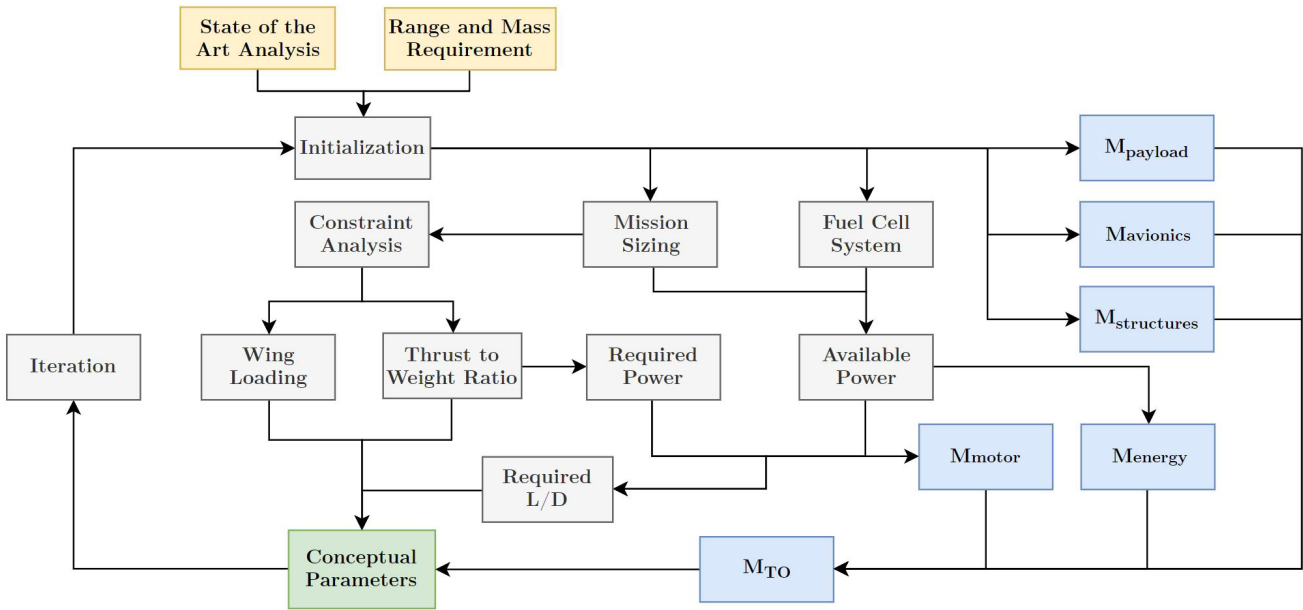

Figure 10: Conceptual Design Flow Chart.

pect ratios near 15. The Oswald efficiency factor is calculated for a trapezoidal wing with an aspect ratio of 15 without wing sweep.

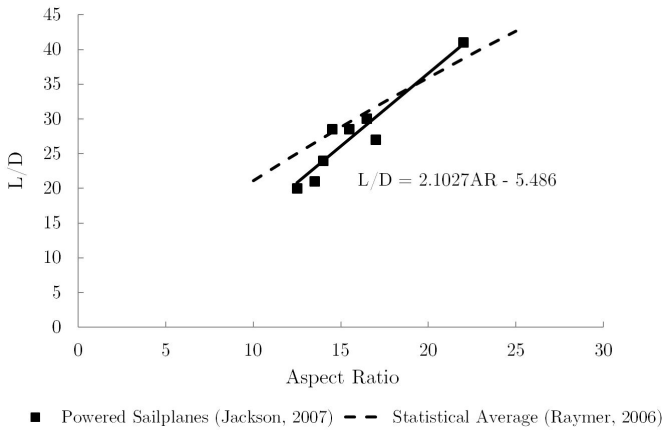

Figure 11: Statistical relationship between L/D and aspect ratio for sailplanes.

4.1.2 Initial Baseline Design Case

From the process of iterating the initialization variables, several feasible configurations are obtained. The cruise velocity of the aircraft is settled at 23 m/s at an operating altitude of 300 m and the maximum payload size is considered to be 1 kg as it results in an achievable L/D . Furthermore, from the state of the art and benchmarking hydrogen fuel cell

Parameter	Value
Aspect Ratio	15
Wing Sweep (°)	0
Dihedral Angle (°)	6
Taper Ratio	0.45
Parasite Drag Coefficient	0.0165
Oswald Efficiency Faactor	0.76

Table 5: Summary of Geometric Aircraft Parameters..

based UAS, a structural mass fraction of 0.38 has been set for the baseline aircraft and it is estimated that the in flight data transmission can be achieved with an avionics mass of 0.5 kg. However, a redundancy battery system will also be added to the avionics mass bringing the total to 1.22 kg. Gundlach [1] suggests that a depth of discharge, f_{DOD} , of 80% is the maximum allowable discharge before reducing the battery efficiency below 0.9. For a lithium-polymer battery, this efficiency is deemed reasonable from also consulting Gatti [8]. From Roskam [12], an energy reserve of 20% is considered sufficient to provide the extra power for the climb and descent segments as well as it serving as a reasonable safety margin to ensure that the mission’s design range is achieved. The following Tables 6 and 7 summarize the input and state of the art parameters used for the initial design configuration.

Most notably though from the process, it is determined that the 250 W fuel cell is unable to provide a sufficient output power, whereas the 500 W system (Aerostak 500 from Table 3) is adequate. Therefore, the 1000 W system will lead to an

Parameter	Value	Unit
R	3×10^6	m
M	≤ 25	kg
$M_{payload}$	1	kg
$M_{avionics}$	1.2	kg
V_{cruise}	23	m/s
Rate of climb	1	m/s
Climb angle	3	°

Table 6: Design Case Input Parameters.

Parameter	Value	Unit
MF_{struct}	0.38	—
M_{motor}/P_{shaft}	0.25	g/W
η_p	0.8	—
η_m	0.85	—
η_e	0.9	—
η_f	0.95	—
η_b	0.9	—
f_{DOD}	0.8	—

Table 7: State Of the Art Parameters.

unnecessary mass increase of the aircraft, resulting in the 500 W system being the most appropriate. With regards to the quantity of hydrogen cylinders (please note that we are considering the gas state of the hydrogen), only the two cylinder configuration is able to achieve the range requirement with a L/D below 30 while meeting the mass requirement, as shown in Table 8.

No. of Cylinders	MTOW (kg)	L/D_{req}
1	12.7	37.9
2	19.5	29.5
3	26.4	26.7

Table 8: Comparison between No. of Hydrogen Cylinder for a 500 W Fuel Cell System.

4.2 Configuration and Layout

The outputs of the configuration layout task are design drawings of the aircraft as well as geometric information required for further analysis in the preliminary design phase. For the aircraft, a T-tail configuration with a tractor propeller has been selected. The placement of the horizontal tail on top of the vertical fin provides increased leverage and assists with stability. Additionally, due to its higher placement, it will remain in undisturbed flow during a stall. As a consequence of the smaller required vertical tail, the T-tail can be lighter and due to the increased leverage, the horizontal tail can also be smaller. This reduces the friction drag, as well as there

being less interference drag as a result of raising the horizontal tail. Due to the short nature of the fuselage and the low structural support of the introduced boom, a tractor propeller will be employed. Propellers mounted on the wings were also investigated, however, the idea was ultimately dismissed due to the increased complexity and weight increase, as two sets of smaller motors and propellers will be heavier than a single motor and propeller system (Gatti [8]). Shown in Figure 12 is the initial internal layout of the aircraft. Two detail views, A and B, are shown for the front and rear fuselage sections respectively. Each labeled component from Figure 12 is detailed in Table 9. Note that it is not an exhaustive drawing of all internal components, with components such as the avionics and additional battery system not being included. This schematic serves as an initial internal layout and will be refined in the preliminary design. The key finding from this drawing is that the hydrogen cylinders occupy majority of the internal space and that the fuselage may need to be extended in the preliminary design phase to embed all required internal components.

Component Description
1 Forward Hydrogen Cylinder - A12
2 Rear Hydrogen Cylinder - A12
3 Fuel Cell - Aerostak 500
4 Motor
5 Propeller and Hub
6 Beginning of Boom

Table 9: Conceptual Schematic Description.

4.3 Summary of Conceptual Design

The conceptual design of the transatlantic hydrogen powered UAS resulted in a 19.5 kg aircraft that with a lift to drag ratio of approximately 29.5 can feasibly cross the Atlantic Ocean. The wing, fuselage, empennage and propulsion system were appropriately sized to meet the mission objectives. Major aircraft and mission parameters are detailed in Tables 10, with wing and fuselage parameters shown in 11.

Parameter	Value	Unit
M_{TO}	19.5	kg
$M_{payload}$	1	kg
L/D_{req}	29.5	—
Altitude	300	m
V_{cruise}	23	m/s

Table 10: Aircraft and Mission Parameters.

The fuel cell and power plant characteristics are summarized in Table 12 and the empennage is detailed in Table 13, with an isometric drawing of the aircraft shown in Figure 13.

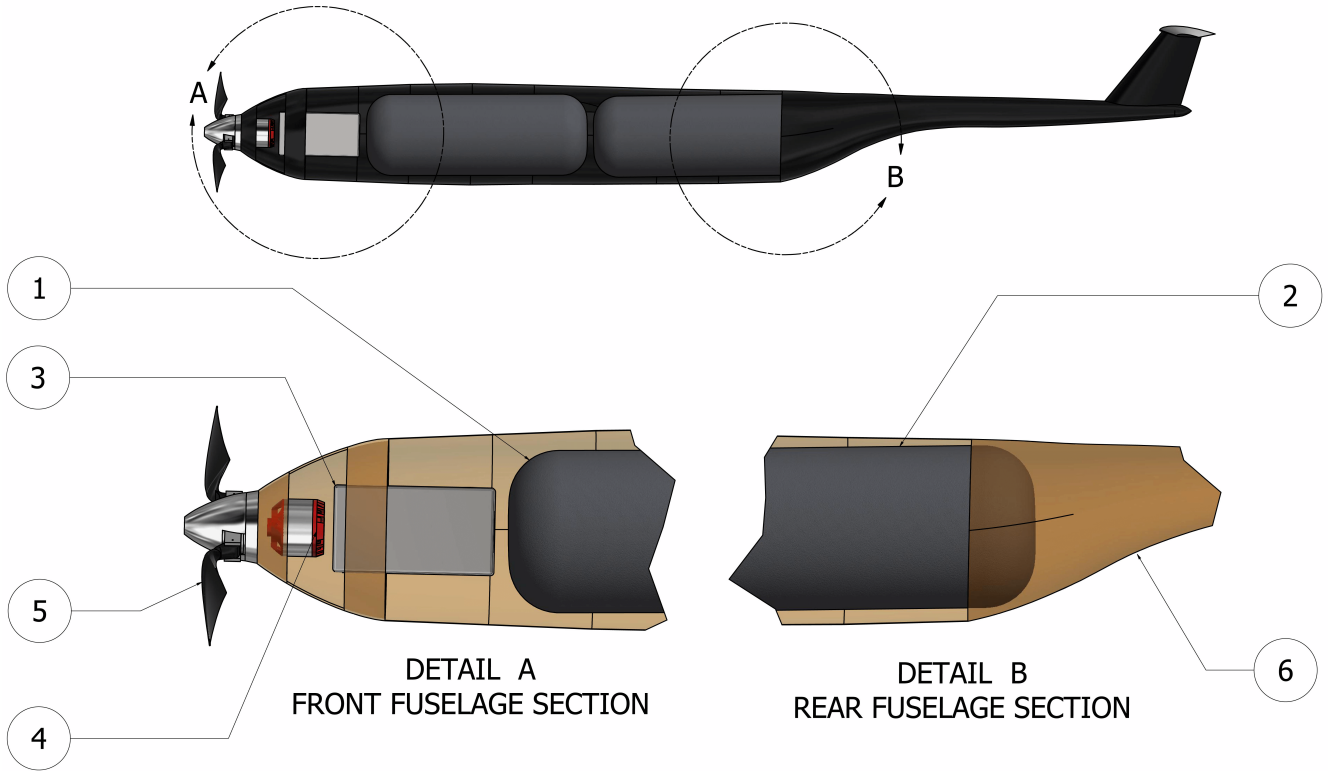

Figure 12: Internal Schematics of Conceptual Design.

Parameter	Value	Unit
S_{ref}	0.85	m ²
b_{ref}	3.6	m
AR	15	–
$L_{fuselage}$	2.3	m
$D_{fuselage}$	0.25	m

Table 11: Wing and Fuselage Design Parameters.

Parameter	Value	Unit
P_{fc}	500	W
E_{fc}	955	Wh/kg
T_O	9	N
$P_{inputcruise}$	274	W
$D_{propeller}$	0.375	m

Table 12: Fuel Cell and Power Plant Parameters.

5 ATMOSPHERIC ENERGY AS A POTENTIAL FOR PERFORMANCE IMPROVEMENT

Various styles of flight could be noticed while bird watching. According to Scott and McFarland [13] birds use several strategies of energy harvesting, which serve as an inspiration for all the current improvements in the field of UAV long endurance performance. Interaction of wind and obstacles such as buildings, hills, or waves generates an ascending component of air motion. Many birds with knowledge of soaring techniques use these updrafts to power their flight instead of wing flapping.

In case of unequal heating of Earth's surface provoked, for example, by punctured cloud layer, implies uplift of hot air, known as thermal. Eagles, condors, vultures, and many other large birds use these updrafts with a technique called

thermal soaring in order to extend their endurance while searching for a prey. Another example is sweeping flight within the gust pushed by the waves. Gulls and pelicans use these gusts to power their flight by flying along the wave cliffs. Gaining speed while wave slows down, they are able to pull up and glide to another wave where the process continues.

As there are many examples in nature, Albatrosses are particularly adept at exploiting wind gradients above sea level and can travel many thousands of kilometers using very little energy from flapping. Albatrosses and other birds that soar dynamically also have a skeletal structure that allows them to lock their wings when they are soaring, so the bird can continue flying almost indefinitely without having to put in much effort besides steering. In effect, it is harvesting energy

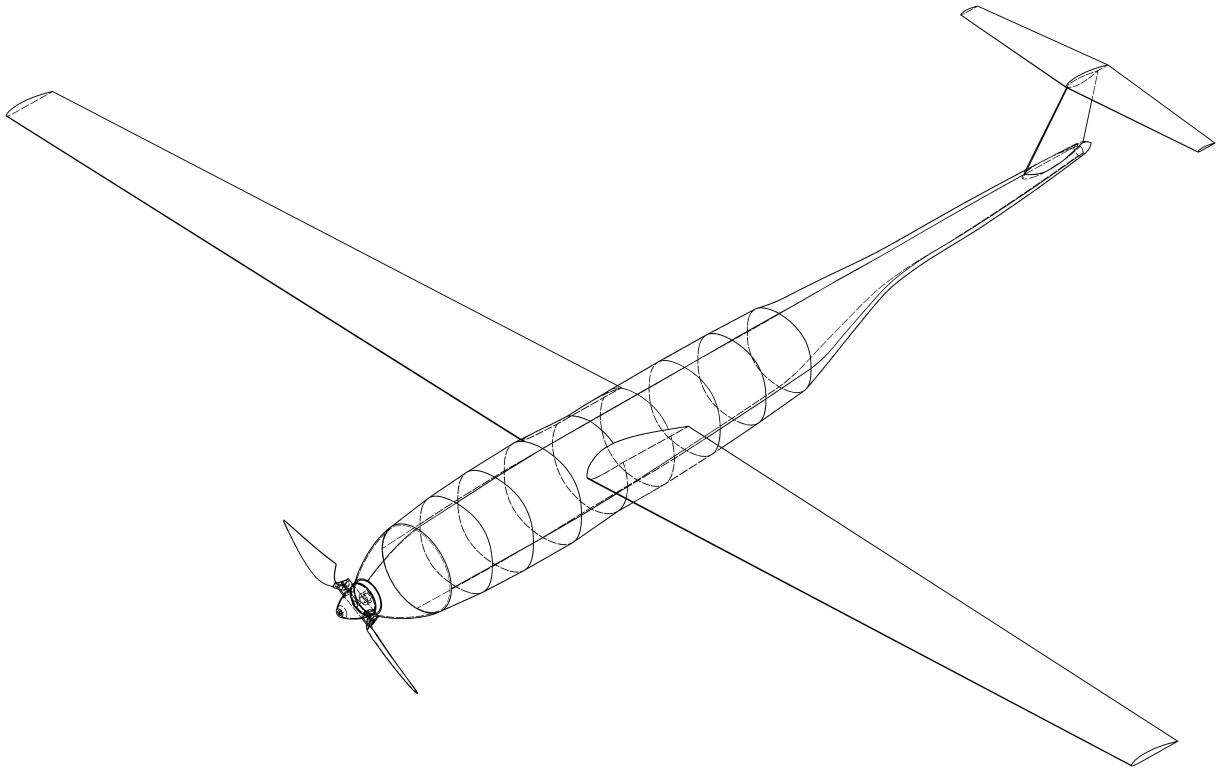

Figure 13: Isometric Drawing of Conceptual Transatlantic UAS.

Parameter	Value	Unit
S_{HT}	0.067	m^2
S_{VT}	0.039	m^2
AR_{HT}	8	—
AR_{VT}	1.6	—
$VT_{location}$	2.1	m

Table 13: Empennage Design Parameters.

from the wind gradient.

Those biologically inspired flight techniques would not be possible if the birds were not equipped with natural sensory systems for the detection of atmospheric phenomena. Severe turbulent flows will cause the feathers to vibrate and gyrate wildly. As the feathers are elevated by the air stream, mechanoreceptors increase their discharge frequency. However, it is clear that identical copies from nature to man-made technologies are still not feasible. It took millions of years for evolution to develop such extraordinary sensory systems and skills of natural fliers. On the other hand, an imaginative inspiration and transformation into technology are often based on various steps of abstraction. Finally, it should also be pointed out that besides biologically inspired flight techniques, birds also serve as an inspiration for an extensive amount of extraordinary aerodynamic structures that are in service of per-

formance improvement. An overview of aerodynamic structures for aircraft drag reduction inspired by wingtips of some natural fliers has been investigated by Gavrilovic et al [14].

5.1 Biologically Inspired Sensory Systems

5.1.1 Pressure Measurements on the Wing

The paper from Gavrilovic [15, 16] reveals a system for the local angle of attack estimation based on pressure measurements on the wing. The idea implies that a certain pair of pressure ports is located on the wing, as shown on Figure 8, where one port is on the upper surface of the chosen section, while the other is on the lower surface. Those points are recording a pressure difference with time which has to be normalized with dynamic pressure in order to enable the effectiveness of the system for various airspeeds. If a single location on the wing measures pressure difference then the estimation of the local angle of attack, including the influence of aileron deflection.

5.1.2 Multi-hole probes

These sensors consist of pressure-based multi-hole probes that can measure flow angles and airspeed in flight. A single tube provides real-time measurement of the local angle of attack and airspeed ahead of the wing. Therefore, several probes placed along wing-span can be used to determine the

gust length scale. This method of flow sensing has been previously demonstrated by Gavrilovic [17]. If gust length scales were equal to or larger than the wingspan, then flight through such a large gust structure would result in only pitching and heaving motion. However, gusts smaller than the wingspan would provoke unequal load distribution along wingspan implying additional roll and yaw moments on the wing. Using multiple probes would ensure that aircraft reacts only within sufficiently large wind field.

5.1.3 Aero booms

Aeroboams can be considered as custom-designed equipment for estimation of wind magnitude and direction, usually based on a single pitot tube which allows measurement of airspeed and a pair of wind vanes for the angle of attack and sideslip angle. The wind vanes are attached to magnetic encoders (acting as a potentiometer) which enable a digital signal to a controller. The advantage of using such equipment is the ease of manufacturing and relatively low cost when compared to sophisticated multi-hole probes or pressure surface systems. The comparison of the angle of attack estimated with Aero boom shown in Figure 14 and angle from pressure measurements on the wing is investigated in the work of Gavrilovic [15].

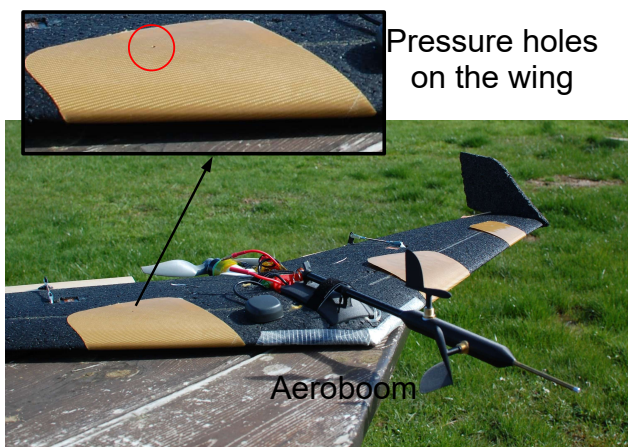

Figure 14: A small UAV equipped with wing pressure system and aeroboom.

5.2 Energy-Harvesting from Atmospheric Phenomena

The analysis that compared different flight strategies through a sinusoidal wind field showed that energy-harvesting flight represents the most favorable flight technique when compare to auto-stabilization or fixed-stick flight. It was also shown that energy-harvesting from wind fluctuations could potentially lead to a very significant savings in invested power that can even go up to 40 %, depending on

the magnitude of wind field. Those results have been presented in the work by Gavrilovic [17]. Another flight technique which utilizes the energy of rising air has been demonstrated by Stroman and Edwards [18]. The previous work has demonstrated more than 100 km flight with a 4 m glider, all without a motor. On the other hand, a shorter cycle of climb within strong wind updraft and significant benefits in reduced invested power has been recorded in the work of Gavrilovic et al. [16]. Another very promising flight technique related to the exploitation of spatial wind gradients is dynamic soaring. This flight technique is usually related to the flight of Wandering Albatross as shown in Figure 15, which can cross enormous distances while being fueled by only couple of grains of food. A dynamic soaring mechanism in the ocean boundary layer has been previously presented by Bonnin [19]. A demonstration of gain in potential energy while exploiting a horizontal wind gradient with reduced power of a small unmanned aerial vehicle has been previously demonstrated by Gavrilovic et al. [16, 17]. Finally, it can be concluded that energy-harvesting represents an opportunity to significantly enhance the performance of a small unmanned aerial vehicle, through extended endurance and range. With equipment for detection of flow magnitude and the direction, the aircraft would be able to apply adequate maneuvers for increasing its energy state.

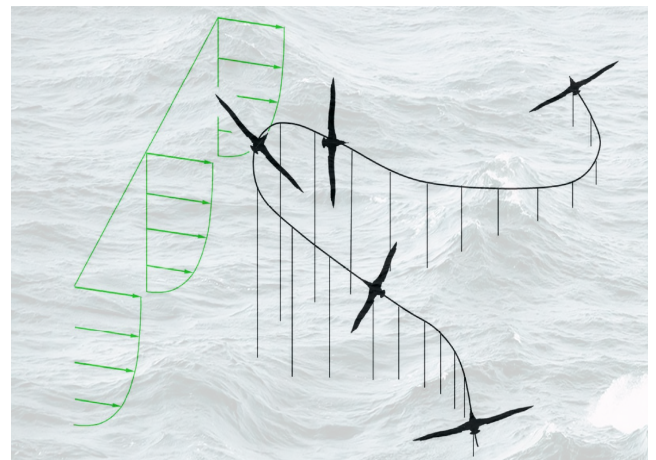

Figure 15: Albatross neutral energy cycle with dynamic soaring.

6 CONCLUSION

The conceptual design phase was conducted using a classical approach, but modified appropriately for a hydrogen fuel cell powered UAS. It involved taking the inputs from the mission objectives and iteratively outputting the aircraft mass, required L/D , wing loading and thrust to weight ratio until a baseline configuration that can feasibly cross the Atlantic Ocean was achieved. The initial analysis has also proved

that crossing a distance of 3000 km would not be possible with only Li-Po batteries. On the other side, a significant rise in specific energy density provided by fuel cells ensures that crossing the Atlantic Ocean is possible. The conceptual design phase resulted in an aircraft with a maximum take off mass of around 20 kg and cruise velocity of 23 m/s that is capable of carrying a 1 kg payload. The reference wing area of 0.85 m² and wing span of 3.6 m are sized according to a wing loading that met all operational constraints. Furthermore, the 500 W fuel cell unit and 274 W cruise motor power are sized from the thrust to weight ratio obtained from the constraint analysis. Future work for this project includes transitioning into the preliminary design phase, where the conceptual design will be refined. An optimal combination of airfoil and horizontal tail position are to be determined as well as an in-depth sizing of the heavily coupled motor and propeller. Further modifications to the aircraft will also be investigated such as incorporating geometric twist to the wings and adding wingtip devices to minimize the induced drag. These modifications are to be studied by using Vortex Lattice Method (VLM) and Computational Fluid Dynamics (CFD) programs. This work has also presented some of the bio-inspired systems for wind speed and direction measurements. Besides their primary function, those devices can also be used as stall-recovery systems, as they can locally estimate the angle of attack on the wing. Moreover, those bio-inspired systems can be also applied as a way of sensing atmospheric phenomena that can be exploited by an aircraft. In such a way the aircraft performance can significantly be enhanced by utilizing the energy of the atmosphere.

ACKNOWLEDGEMENTS

The authors are grateful to Mehmet Kesmez from HES Energy Systems for all the useful information related to the latest technology of hydrogen fuel cells.

REFERENCES

- [1] J. Gundlach. *Designing Unmanned Aircraft Systems: A Comprehensive Approach*. American Institute of Aeronautics and Astronautics, Reston, VA, 2014.
- [2] P. Osenar, J. Sisco, and C. Reid. Advanced propulsion for small unmanned aerial vehicles. Technical report, Ballard Canada, 2017.
- [3] Sparkle Tech. Eagle plus vtol 3.5m, 2019. <http://www.sparkletech.hk/electric-power/eagle-plus-vtol/>.
- [4] K. Swider-Lyons, K. MacKrell, J. A. Rodgers, G. S. Page, M. Schuette, and R. O. Stroman. Hydrogen fuel cell propulsion for long endurance small uavs. In *AIAA Centennial of Naval Aviation Forum.*, 2011.
- [5] H3 Dynamics. Hywings, 2016. <http://www.h3dynamics.com/products/hywings/>.
- [6] EASA. Introduction of a regulatory framework for the operation of unmanned aircraft., 2015. European Aviation Safety Authority.
- [7] Insitu. Scan eagle capabilities, 2018. <https://www.insitu.com>.
- [8] M. Gatti. Complete preliminary design methodology for electric multirotor. *Journal of Aerospace Engineering*, 30(5):1–15, 2017.
- [9] HES Energy Systems. Aerostak ultra-light fuel cells, 2019. <https://www.hes.sg/aerostak>.
- [10] HES Energy Systems. Series-a tanks, 2019. <https://www.hes.sg/accessories>.
- [11] D. Raymer. *Aircraft Design: A Conceptual Approach*. American Institute of Aeronautics and Astronautics, Reston, VA, 2006.
- [12] J. Roskam. *Airplane Design Part I: Preliminary Sizing of Airplanes*. DARcorporation., Lawrence, KA, 2004.
- [13] C. Scott and C. McFarland. *Bird feathers - a guide to North American species*. Mechanicsburg: Stackpole Books., 2010.
- [14] N. Gavrilovic, B. Rasuo, G. Dulikravich, and V. Parezanovic. Commercial aircraft performance improvement using winglets. *FME Transactions*, 43(1):1–8, 2015.
- [15] N. Gavrilovic, M. Bronz, and E. Benard J-M. Moschetta. Bioinspired wind field estimation-part i: Angle of attack measurements through. *International Journal of Micro Air Vehicles*, 10(3):273–284, 2018.
- [16] N. Gavrilovic, M. Bronz, and E. Benard J-M. Moschetta. Bioinspired energy harvesting from atmospheric phenomena for small unmanned aerial vehicles. In *AIAA SciTech Forum, San Diego, CA.*, 2019.
- [17] N. Gavrilovic, A. Mohamed, M. Marino, S. Watkins, J-M. Moschetta, and E. Benard. Avian-inspired energy-harvesting from atmospheric phenomena for small uavs. *Bioinspiration and Biomimetics*, 14(1):1–20, 2019.
- [18] R. Stroman and D. Edwards. The hybrid tiger: A long endurance solar/fuel cell/soaring unmanned aerial vehicle. In *DOE Annual Merit Review, US Naval Research Laboratory, Washington DC*.
- [19] V. Bonnin, E. Benard, C. Toomer, and J-M. Moschetta. Dynamic soaring mechanism in the ocean boundary layer. *Int. J. Engineering Systems, Modelling and Simulation*, 8(2):136–148, 2016.