



HAL
open science

Development of a 6-Degrees-of-Freedom Hybrid Interface Intended for Teleoperated Robotic Cervical Spine Surgery

Alizée Koszulinski, Juan Sandoval, Marc Arsicault, Med Amine Laribi

► **To cite this version:**

Alizée Koszulinski, Juan Sandoval, Marc Arsicault, Med Amine Laribi. Development of a 6-Degrees-of-Freedom Hybrid Interface Intended for Teleoperated Robotic Cervical Spine Surgery. *Journal of Mechanisms and Robotics*, 2025, 17 (2), pp.021007. 10.1115/1.4065917. hal-04717595

HAL Id: hal-04717595

<https://hal.science/hal-04717595v1>

Submitted on 2 Oct 2024

HAL is a multi-disciplinary open access archive for the deposit and dissemination of scientific research documents, whether they are published or not. The documents may come from teaching and research institutions in France or abroad, or from public or private research centers.

L'archive ouverte pluridisciplinaire **HAL**, est destinée au dépôt et à la diffusion de documents scientifiques de niveau recherche, publiés ou non, émanant des établissements d'enseignement et de recherche français ou étrangers, des laboratoires publics ou privés.

Development of a 6 degrees-of-freedom hybrid interface intended for teleoperated robotic cervical spine surgery

Alizée Koszulinski¹

Department GMSC – Pprime Institute, CNRS – University of Poitiers – ENSMA,
Poitiers 86073, France

e-mail: alizee.koszulinski@univ-poitiers.fr

Juan Sandoval

Nantes Université, École Centrale Nantes, CNRS, LS2N, UMR 6004,
Nantes 44000, France

e-mail: juan.sandoval@ls2n.fr

Marc Arsicault

Department GMSC – Pprime Institute, CNRS – University of Poitiers – ENSMA,
Poitiers 86073, France

e-mail: marc.arsicault@univ-poitiers.fr

Med Amine Laribi

Department GMSC – Pprime Institute, CNRS – University of Poitiers – ENSMA,
Poitiers 86073, France

e-mail: med.amine.laribi@univ-poitiers.fr

ASME Member

ABSTRACT

This paper deals with the development of a 6-degrees-of-freedom (DoF) hybrid interface for a teleoperated robotic platform intended to assist surgeons in cervical spine surgery. The targeted task is the drilling of cervical vertebrae for the attachment of spinal implants. Given the complex anatomy of the cervical region, with the proximity of the spinal cord and vertebral arteries, high accuracy in the drilling procedure is required to avoid complications for the patient. In this context, the proposed hybrid interface has been designed to meet the requirements of the drilling task, in terms of degrees of freedom, workspace and force feedback,

¹ Corresponding author.

35 *which have been identified through a literature review. It consists of an association of two parallel*
36 *mechanisms and a centrally located serial mechanism. Direct and inverse kinematic modelling of each*
37 *mechanism as well as the one of the complete interface were carried out. A study of the dexterity distribution*
38 *of the parallel mechanisms was carried out in order to select the suitable interface working mode that would*
39 *keep the singularities away from the prescribed workspace. In addition, the force feedback was*
40 *implemented in static mode, neglecting in a first time the weight of the system. The interface design*
41 *parameters were then optimized to avoid singularities within the prescribed workspace, to minimize motor*
42 *torques, and to reduce the size of the interface. These development stages led to the design of a motorized*
43 *prototype of the hybrid interface.*

44 *Keywords: hybrid interface, force feedback, direct and inverse kinematic models, optimization, cervical spine*
45 *surgery.*

46

47 **1. INTRODUCTION**

48

49 The orthopaedic surgery of interest to this work is called posterior cervical
50 arthrodesis. This surgical procedure aims to treat cervical spine instabilities, which can
51 result from degenerative diseases or trauma. When the spinal deformity is significant or
52 the pathology is deemed to be at an advanced stage, surgery may be recommended to
53 relieve the patient. Arthrodesis is a surgical technique that enables at least two vertebrae
54 to be fused together, i.e. permanently consolidated. This operation frees the nerves
55 and/or spinal cord, where these were previously compressed, and stabilizes the spine,
56 the aim being to maintain a normal spacing between each vertebra. To achieve this, the
57 surgeon has to drill holes in specific areas of the vertebrae so that spinal implants can be
58 attached. These implants generally consist of screws and fixation rods (see Fig. 1). Each
59 drilling of a cervical vertebra must be performed along an optimal trajectory defined by
60 the surgeon according to an entry point, a direction, a diameter and a depth [1].

61 Identifying this optimal trajectory requires an in-depth knowledge of the anatomy of each
62 of the patient's vertebrae. Given the proximity of the spinal cord and vertebral arteries
63 that supply oxygenated blood to the brain, an incorrectly positioned screw could pose
64 significant risks to the patient. High-accuracy drilling is therefore essential to preserve all
65 the structures and vessels adjacent to the cervical spine.

66

67

68 *Fig. 1 Illustration of posterior cervical arthrodesis*

69 The integration of a robotic device into this surgical procedure should improve the
70 surgeon's abilities, particularly in terms of accuracy when performing the drilling, as it has
71 been observed in thoracic spine surgery [2]. Currently, the existing robotic arms used for
72 orthopaedic surgery are developed to be controlled in a comanipulation scheme, i.e. with
73 a direct manipulation of the robotic arm by the surgeon [3]. To our knowledge, no remote-
74 controlled robotic platform, known as teleoperation, has been developed for orthopaedic
75 surgery, including spine surgery. A major advantage of a teleoperation platform is that it
76 provides a more ergonomic and comfortable sitting position for the surgeon, as opposed
77 to standing and bending over the surgical field for several hours. In this context,
78 teleoperation could improve surgeon's endurance by reducing fatigue as the drilling
79 procedure progresses. Besides enhancing comfort, the reduction in surgeon fatigue could
80 help maintain precision of movements throughout the surgery. Consequently, the
81 development of an interface adapted to the drilling gesture is necessary to enable the
82 adaptation of a comanipulation platform [4] to a remote control [5].

83 **1.1. Existing rigid-link interfaces**

84
85 Rigid-link interfaces can be classified into three categories according to their kinematic
86 chain: serial architectures with joints connected in series, parallel architectures with one or
87 more closed kinematic chains and hybrid architectures with a combination of serial and
88 parallel mechanisms.

89

90

91 *Fig. 2 (a) Virtuose 6D by Haption, (b) Omega 3 parallel interface by Force Dimension, (C) MEPaM developed by*
92 *Abeywardena et al. and (d) Hybrid interface developed by Meskini et al.*

93 The Virtuose 6D interface from the company Haption (Soulge-Sur-Ouette, France) thus
94 belongs to the class of serial interfaces (see Fig. 2a). This interface was used by Ewerton
95 *et al.* to develop a tool for real-time correction of motor skills during calligraphy exercises
96 [6]. On the other hand, the PHANToM Desktop serial device from SensAble Technologies
97 (Woburn, MA) was used to develop a bone preparation simulator in the dental field [7].
98 Concerning parallel interfaces, the Novint Falcon developed by Novint Technologies
99 (Albuquerque, NM) and initially intended for the entertainment industry, is currently being
100 used at the Pprime Institute (Poitiers, France) to assist ultrasound examinations using a
101 remotely-operated robotic platform [8]. In addition, the company Force Dimension (Nyon,
102 Switzerland) offers a range of interfaces, called "Omega" (see Fig. 2b), particularly
103 dedicated to the field of medical robotics. In the same field, the MEPaM ("Monash
104 Epicyclic Parallel Manipulator") has been developed by Abeywardena *et al.* for the
105 simulation of laparoscopic surgery (see Fig. 2c) [9].

106 In the category of hybrid interfaces, Delta 6 device marketed by Force Dimension or the
107 hybrid architecture with four degrees of freedom developed by Meskini *et al.* [10]
108 developed for laparoscopic surgery (see Fig. 2d) can be cited.

109 Each of the above interface classes has its own advantages and disadvantages, which may
110 direct its use for certain applications, depending on the constraints imposed, such as
111 accuracy, compactness of the device, or the workspace it has to cover. The main features
112 associated with each type of architecture are summarized in Table 1 below.

113 *Table 1 Main advantages and disadvantages of the rigid-link interface classes*

114

115

116 **1.2. Novel hybrid interface for cervical spine surgery**

117

118 As mentioned previously, cervical spine surgery requires great accuracy. For an interface,
119 the rigidity of a mechanism is a key factor to guarantee its accuracy. Furthermore, the
120 interface should be easily adaptable to the specified workspace of the drilling task.

121 Considering the abovementioned advantages, a hybrid architecture was chosen for the
122 development of our interface dedicated to cervical surgery.

123 The key contributions of this work can be summarized as:

124

(1) Development of a new 6-degrees-of-freedom hybrid architecture.

125

(2) Decoupling of the degree of freedom associated with the drilling axis, allowing
126 better control of the latter.

127

(3) Possibility of repositioning a center of rotation (CoR).

128

(4) Formulation of the relationship between input forces and active joint torques
129 tailored to the needs of a vertebra drilling task.

130 This paper is structured as follows: Section 2 gives the specifications associated with the
131 procedure of vertebrae drilling regarding the workspace and force feedback. Section 3
132 describes the proposed hybrid architecture and details the kinematic models of each
133 mechanism as well as the complete interface. Section 4 presents the relationship between
134 the input forces and the active joint torques. The optimization of the design parameters of
135 the interface is discussed in section 5, which also presents the final design of a motorized
136 prototype. Section 5 concludes this paper.

137 **2. DRILLING TASK SPECIFICATIONS**

138

139 **2.1. Prescribed workspace definition**

140

141 Identifying the specificities of the surgical procedure is essential for the development and
142 sizing of an interface adapted to the drilling gesture. For this purpose, the drilling procedure
143 can be divided into 3 steps whose required degrees of freedom can be defined and the
144 linked workspace evaluated.

145

146

147 *Fig. 3 Illustration of the drilling procedure and the prescribed workspaces*

148 The first step consists in the positioning of the surgical drill at the desired entry point thus
149 involving the three translational DoF (see Fig. 3a). Once the tip of the drill is positioned,
150 the surgeon must adjust the orientation of the tool to perfectly align it with the optimal
151 drilling direction (see Fig. 2b). This second step therefore requires rotations around the \vec{x}
152 and \vec{y} axes of the tool. The self-rotation, around \vec{z} axis, can be neglected because it
153 corresponds to the rotation axis of the drill. However, in the context of a robotic application,
154 this rotation can be an advantage when avoiding singular configurations by modifying the
155 posture of the robotic arm. The last step of the gesture is the drilling performing along the

156 longitudinal axis of the drill corresponding to the \vec{z} axis (see Fig. 3c). In summary, the need
157 for 6 DoF was retained to fully control a robotic arm during a drilling procedure.
158 Several drilling gestures were investigated to further define the workspace specifications
159 of the interface. Insertion of articular screws, superior and inferior transarticular drilling,
160 translaminar and pedicular screw fixation were thus analysed through a literature review.
161 These five techniques are linked to the anatomical region drilled in each vertebra during
162 surgery. In order to quantify the drilling parameters for each type of gesture, 25 articles
163 have been retained, corresponding to a study of almost 11,500 screw insertions [11-36].
164 For each article and each drilling gesture, the following data were collected: the minimum
165 and maximum drilling depth and diameter, as well as the maximum angular amplitude of
166 the surgical drill (see Fig. 4).

167

168

169 *Fig. 4 Summary of the results of the literature review conducted on the drilling parameters of five different drilling*
170 *gestures*

171 Based on this data, prescribed workspaces associated with the drilling task can be defined.
172 First, the maximum workspace of the surgical drill corresponds to a cone with an apex
173 angle of $\pm 29^\circ$ and a height of 52 mm (see Fig. 3b and 3c). At the vertebral level, this
174 drilling cone must be repositioned to correct the location of the tool tip, associated with the
175 apex of the cone, thus allowing correct alignment between the axis of the tool and the
176 optimal direction of drilling. Accordingly, this first workspace is extended by allowing
177 translation of the top of the drilling cone inside a cylinder with a diameter and height equal
178 to 20 mm, i.e. more than four times the maximum diameter of a cervical screw (see Fig. 3b
179 and 3c).

180 At the level of the spine, a second workspace must be considered in order to position the
181 tip of the tool close to the desired drilling entry point and also pre-orientate the tool,
182 knowing that the average drilling angles vary depending on the anatomical region
183 considered. This second workspace can be represented by a displacement cube, at the
184 center of which the orientation of the tool can be adjusted (see Fig. 3a).

185 **2.2. Drilling interaction forces**

186
187 Following the definition of the prescribed workspaces for the task of drilling the cervical
188 vertebrae, a second literature review was carried out to evaluate the forces applied during
189 the surgical procedure. The aim was to define the interaction forces that the interface should
190 be able to generate in order to provide realistic force feedback to the surgeon while
191 remotely controlling the robotic arm.

192 A total of 7 articles and one thesis paper were retained [37-44]. The latter present the results
193 in terms of force feedback during the performance of more than one hundred drills on
194 vertebrae of different types: human, bovine, porcine and ovine, whose vertebral anatomy
195 is similar to that of humans. Like the femur or the frontal bone of the skull, vertebrae are
196 composed of a cortical part and a spongy part. The cortical bone is the dense, rigid external
197 layer of the bone, corresponding to the white areas on an X-ray (see Fig. 5a). Spongy or
198 cancellous bone, on the other hand, is porous and is located mainly inside the protective
199 envelope formed by the cortical bone.

200 Figure 5a shows the typical curve of the force applied along the drilling axis, which can be
201 divided into 4 phases. The first phase consists of the tool advancing until the first contact
202 with the vertebra (A). Next, a peak in force is felt during the drilling of the first layer of
203 cortical bone (B). The force curve then decreases as the tool enters the cancellous bone (C).

204 A second peak in force is sometimes seen, which is synonymous with reaching the second
205 layer of cortical bone (D).

206 In the context of developing an interface for remotely controlling a robot to perform
207 surgery, it's therefore crucial to transmit the interaction forces between the tool and the
208 vertebra being drilled to the surgeon. This allows the surgeon to feel in which bony part
209 the drill is located, thus avoiding the risk of unwanted vertebral perforation and potential
210 damage to adjacent structures such as the spinal cord or vertebral arteries.

211

212 *Fig. 5 (a) Typical curve of the evolution of the force applied along the drilling axis and (b) histograms of the*
213 *maximum values of force and moment found in the literature*

214 The histograms in Fig. 5b show the maximum force and moment values found in the
215 literature in the three directions, where \vec{z} axis corresponds to the drilling axis. These results
216 led to the definition of the maximum force limits that the interface should be able to
217 generate, which were set at 30 N along the drilling axis, 10 N along the transverse axes and
218 0.5 N.m for the three directions of rotation.

219

220 **3. THE PROPOSED 6 DOF HYBRID INTERFACE**

221

222 **3.1. Description of the architecture**

223

224 Considering the specific requirements for cervical vertebral drilling, a hybrid architecture
225 interface is proposed. It combines two parallel mechanisms and a centrally located serial
226 mechanism. The upper mechanism, a 3-RRR (R: revolute) planar parallel mechanism,
227 enables two translations in the mechanism plane (see Fig. 6a). The lower 3-RRR
228 mechanism allows two in-plane translations and one rotation through its mobile platform
229 connected to three serial chains (see Fig. 6b). Connecting the end-effectors of the two
230 parallel mechanisms by a central rod allows three degrees of rotation and three degrees of

231 translation. However, the translation orthogonal to the parallel mechanisms is limited and
232 only relies on the central rod rotational movements (see Fig. 6c). A serial mechanism, fixed
233 to the central rod and corresponding to an helical joint, thus provides complete control of
234 this last translation associated with the drilling axis (see Fig. 6d). The assembly of the
235 parallel and serial mechanisms must cover the displacement cube, keeping the orientation
236 of the central rod fixed, in relation to the prescribed workspaces previously defined (see
237 Fig. 3). In addition, it should cover the displacement cylinder and the drilling cone,
238 allowing for modification of the position of the central rod CoR and its orientation.

239

240

241 *Fig. 6 Representation of the interface architecture and the degrees of freedom obtain with each mechanism: (a) the*
242 *upper mechanism, (b) the lower mechanism, (c) the assembly of the two parallel mechanisms and (d) the serial*
243 *mechanism*

244 Seven actuators will be used to handle the control of the proposed hybrid interface: three
245 for each parallel mechanism and one for the serial mechanism. The upper mechanism being
246 controlled with three actuator and allowing two degrees of freedom has thus one degree of
247 redundancy.

248 **3.2. Direct and inverse kinematic models of each mechanism**

249

250 *3.2.1. Lower parallel mechanism*

251

252 The best-known resolution method for solving the direct kinematic model (DKM) of a 3-
253 RRR mechanism with a moving platform is the one proposed by Gosselin [45]. This
254 method consists in considering the central part of the parallel mechanism made up of the
255 mobile platform and the six passive revolute joints, i.e. a 3-RPR (P: prismatic) type
256 mechanism whose prismatic links have a fixed length. Knowing the joint positions of the
257 active revolute joint, the coordinates of the first passive revolute joint of each serial chain

258 are known. In a reference frame associated with these first passive revolute joint, the
 259 coordinates of the three vertices of the mobile platform can be defined. This method leads
 260 to a 6th degree polynomial whose roots correspond to the six DKM solutions. The addition
 261 of an encoder on one of the passive revolute joints is then essential to identify the correct
 262 solution among the six. However, since the interface is used to control a robotic device
 263 online, the resolution time of this method is not compatible with a real-time application
 264 [46]. To cope with this issue, another resolution method, called serial, can be implemented.
 265 This serial method consists of considering only one of the three serial chains of the parallel
 266 mechanism to solve the DKM. This method requires the use of two sensors on the two
 267 passive revolute joints. Considering the serial chain n°1 (see Fig. 7), the coordinates of
 268 point B_1 associated with the first passive revolute joint of the chain can first be calculated
 269 as a function of the joint position α_1 of actuator A_1 such that:

$$\begin{cases} x_{B_1} = x_{A_1} + l_1 \cos(\alpha_1) = l_1 \cos(\alpha_1) \\ y_{B_1} = y_{A_1} + l_1 \sin(\alpha_1) = l_1 \sin(\alpha_1) \end{cases} \quad (1)$$

270 where $x_{A_1} = y_{A_1} = 0$ since point A_1 is the origin of the base reference frame R_0 and l_1
 271 correspond to the length of the first serial chain segment.

272

273

274 *Fig. 7 Kinematic representation of (a) the lower parallel mechanism and (b) its mobile platform*

275 Using the angle ε_1 given by the sensor, the coordinates of point C_1 can be expressed as:

$$\begin{cases} x_{C_1} = x_{B_1} + l_2 \cos(\alpha_1 + \varepsilon_1) \\ y_{C_1} = y_{B_1} + l_2 \sin(\alpha_1 + \varepsilon_1) \end{cases} \quad (2)$$

276 where l_2 represents the length of the second serial chain segment.

277 Finally, the two sensors are used to determine the position and the orientation of the mobile
 278 platform defined as:

$$\begin{cases} x_{P_1} = x_{C_1} + l_3 \cos(\alpha_1 + \varepsilon_1 + \varepsilon_2 + \gamma_1) \\ y_{P_1} = y_{C_1} + l_3 \sin(\alpha_1 + \varepsilon_1 + \varepsilon_2 + \gamma_1) \\ \phi_z = \text{atan2}(y_{C_2} - y_{C_1}, x_{C_2} - x_{C_1}) \end{cases} \quad (3)$$

279 with $x_{C_2} = x_{C_1} + \sqrt{3}l_3 \cos(\alpha_1 + \varepsilon_1 + \varepsilon_2)$ and $y_{C_2} = y_{C_1} + \sqrt{3}l_3 \sin(\alpha_1 + \varepsilon_1 + \varepsilon_2)$

280 where l_3 is the radius of the circle with center P_1 and passing through the passive revolute
 281 joints at each vertex of the mobile platform, $\gamma_1 = 30^\circ$ as the mobile platform corresponds
 282 to an equilateral triangle.

283 In order to determine the inverse kinematic model (IKM) of the lower parallel mechanism,
 284 the coordinates of point P_1 can be first expressed in the base reference frame R_0 such as:

$$\begin{cases} x_{P_1} = x_{A_i} + l_1 \cos(\alpha_i) + l_2 \cos(\beta_i) + l_3 \cos(\phi_z + \gamma_i) \\ y_{P_1} = y_{A_i} + l_1 \sin(\alpha_i) + l_2 \sin(\beta_i) + l_3 \sin(\phi_z + \gamma_i) \end{cases} \quad \text{for } i = 1, 2, 3 \quad (4)$$

285 where β_i is associated with the angular position of the first passive revolute joint of the i^{th}
 286 serial chain, $\gamma_2 = \pi - \gamma_1$ and $\gamma_3 = -\frac{\pi}{2}$.

287 The angles β_i , then unknown, can be removed by calculating the expressions $\cos(\beta_i)$ and
 288 $\sin(\beta_i)$, by squaring and summing the two equations of the previous system. The resulting
 289 equation can then be written as $a \cos \alpha + b \sin \alpha - c = 0$, which gives:

$$\begin{aligned} & [2l_1x_{A_i} - 2l_1x_{P_1} + 2l_1l_3 \cos(\phi_z + \gamma_i)] \cos(\alpha_i) \\ & + [2l_1y_{A_i} - 2l_1y_{P_1} + 2l_1l_3 \sin(\phi_z + \gamma_i)] \sin(\alpha_i) \\ & + 2l_3 \cos(\phi_z + \gamma_i) (x_{A_i} - x_{P_1}) + 2l_3 \sin(\phi_z + \gamma_i) (y_{A_i} - y_{P_1}) \quad (5) \\ & + x_{P_1}^2 + x_{A_i}^2 + y_{P_1}^2 + y_{A_i}^2 + l_1^2 - l_2^2 + l_3^2 - 2x_{P_1}x_{A_i} \\ & - 2y_{P_1}y_{A_i} = 0 \end{aligned}$$

290 The expression of the joint positions of the three actuators of the lower parallel mechanism
 291 can thus be defined as follows:

$$\alpha_i = \text{atan2}(b_i, a_i) + \sigma_i \cos^{-1} \left(\frac{c_i}{\sqrt{a_i^2 + b_i^2}} \right) \quad \text{for } i = 1, 2, 3 \quad (6)$$

292 with $a_i = 2l_1x_{A_i} - 2l_1x_{P_1} + 2l_1l_3 \cos(\phi_z + \gamma_i)$, $b_i = 2l_1y_{A_i} - 2l_1y_{P_1} + 2l_1l_3 \sin(\phi_z +$
 293 $\gamma_i)$ and $c_i = -[2l_3 \cos(\phi_z + \gamma_i)(x_{A_i} - x_{P_1}) + 2l_3 \sin(\phi_z + \gamma_i)(y_{A_i} - y_{P_1}) + x_{P_1}^2 +$
 294 $x_{A_i}^2 + y_{P_1}^2 + y_{A_i}^2 + l_1^2 - l_2^2 + l_3^2 - 2x_{P_1}x_{A_i} - 2y_{P_1}y_{A_i}]$.

295 The IKM of the lower parallel mechanism has thus eight solutions, associated with the
 296 eight possible working modes of the 3-RRR mechanism. These modes depend on the sign
 297 of the coefficient σ_i (1 or -1) whose distribution is given in the following table for the three
 298 angles α_i :

299 *Table 2 Possible working modes of the 3-RRR parallel mechanism*

300

301

302 By deriving the IKM with respect to time, it is then possible to determine the parallel and
 303 serial Jacobian matrices, noted \mathbf{A}_1 and \mathbf{B}_1 respectively, such that:

$$\mathbf{B}_1 \dot{\boldsymbol{\alpha}} = \mathbf{A}_1 \dot{\mathbf{x}}$$

$$\begin{bmatrix} d_{11} & 0 & 0 \\ 0 & d_{12} & 0 \\ 0 & 0 & d_{13} \end{bmatrix} \begin{bmatrix} \dot{\alpha}_1 \\ \dot{\alpha}_2 \\ \dot{\alpha}_3 \end{bmatrix} = \begin{bmatrix} e_{11} & f_{11} & g_{11} \\ e_{12} & f_{12} & g_{12} \\ e_{13} & f_{13} & g_{13} \end{bmatrix} \begin{bmatrix} \dot{x}_{P_1} \\ \dot{y}_{P_1} \\ \dot{\phi}_z \end{bmatrix} \quad (7)$$

304 with $d_{1i} = -(-2l_1x_{A_i} \sin(\alpha_i) + 2l_1x_{P_1} \sin(\alpha_i) - 2l_1l_3 \cos(\phi_z + \gamma_i) \sin(\alpha_i) +$
 305 $2l_1y_{A_i} \cos(\alpha_i) - 2l_1y_{P_1} \cos(\alpha_i) + 2l_1l_3 \sin(\phi_z + \gamma_i) \cos(\alpha_i))$, $e_{1i} = -2l_1 \cos(\alpha_i) -$
 306 $2l_3 \cos(\phi_z + \gamma_i) + 2x_{P_1} - 2x_{A_i}$, $f_{1i} = -2l_1 \sin(\alpha_i) - 2l_3 \sin(\phi_z + \gamma_i) + 2y_{P_1} - 2y_{A_i}$

307 and $g_{1i} = -2l_1l_3 \sin(\phi_z + \gamma_i) \cos(\alpha_i) + 2l_1l_3 \cos(\phi_z + \gamma_i) \sin(\alpha_i) - 2l_3x_{A_i} \sin(\phi_z +$
 308 $\gamma_i) + 2l_3x_{P_1} \sin(\phi_z + \gamma_i) + 2l_3y_{A_i} \cos(\phi_z + \gamma_i) - 2l_3y_{P_1} \cos(\phi_z + \gamma_i)$ for $i = 1, 2, 3$.

309 The Jacobian matrix of the lower parallel mechanism is thus written as:

$$\mathbf{J}_1 = (\mathbf{B}_1^{-1}\mathbf{A}_1)^{-1} \quad (8)$$

310 3.2.2. Upper parallel mechanism

311

312 Solving the DKM of the 3-RRR mechanism located at the upper part of the interface is
 313 simpler as it uses three identical serial chains to generate only two translational DoFs,
 314 resulting in one degree of redundancy. Three circle equations of center P_2 (see Fig. 8) and
 315 passing through the passive revolute joints B_i can therefore be define as:

$$(x_{P_2} - x_{B_i})^2 + (y_{P_2} - y_{B_i})^2 = l_5^2 \quad \text{for } i = 4, 5, 6 \quad (9)$$

316 where l_5 represents the length of the second segment of each serial chain.

317

318

319 *Fig. 8 Kinematic representation of the upper parallel mechanism*

320 The coordinates of the end-effector of the upper parallel mechanism can thus be determined
 321 by rearranging the previous equations in matrix form such as:

$$\begin{bmatrix} x_{P_2} \\ y_{P_2} \end{bmatrix} = \begin{bmatrix} 2x_{B_4} - 2x_{B_5} & 2y_{B_4} - 2y_{B_5} \\ 2x_{B_4} - 2x_{B_6} & 2y_{B_4} - 2y_{B_6} \end{bmatrix}^{-1} \begin{bmatrix} x_{B_4}^2 + y_{B_4}^2 - x_{B_5}^2 - y_{B_5}^2 \\ x_{B_4}^2 + y_{B_4}^2 - x_{B_6}^2 - y_{B_6}^2 \end{bmatrix} \quad (10)$$

322 where $x_{B_i} = x_{A_i} + l_4 \cos(\alpha_i)$, $y_{B_i} = y_{A_i} + l_4 \sin(\alpha_i)$ for $i = 4: 6$ and l_4 corresponds to the
 323 length of the first segment of each serial chain.

324 Concerning the IKM, the triangle A_iB_iM is first considered in order to write the following
 325 equation:

$$l_5^2 = l_4^2 + \|\overrightarrow{A_iP_2}\|^2 - 2l_4\|\overrightarrow{A_iP_2}\| \cos(\alpha_i - \theta_i) \quad \text{for } i = 4, 5, 6 \quad (11)$$

326 where θ_i corresponds to the angle between the \vec{x} axis of the base reference frame R_O and
 327 the segment $[A_i P_2]$.

328 The expression of the joint positions of the three actuators of the upper parallel mechanism
 329 is thus:

$$\alpha_i = \text{atan2}(y_{P_2} - y_{A_i}, x_{P_2} - x_{A_i}) + \sigma_i \cos^{-1} \left(\frac{l_5^2 - l_4^2 - \|\overrightarrow{A_i P_2}\|^2}{2l_4 \|\overrightarrow{A_i P_2}\|} \right) \text{ for } i = 4, 5, 6 \quad (12)$$

330 As for the previous 3-RRR mechanism, there are eight IKM solutions depending on the
 331 sign of the coefficient σ_i (see Table 2), in other words, on the mechanism working mode.

332 The Jacobian matrix of this second mechanism is similar to the one obtained for the
 333 previous mechanism, with the terms associated with the rotation removed, such as:

$$\mathbf{B}_2 \dot{\boldsymbol{\alpha}} = \mathbf{A}_2 \dot{\mathbf{x}} \quad (13)$$

$$\begin{bmatrix} d_{21} & 0 & 0 \\ 0 & d_{22} & 0 \\ 0 & 0 & d_{23} \end{bmatrix} \begin{bmatrix} \dot{\alpha}_1 \\ \dot{\alpha}_2 \\ \dot{\alpha}_3 \end{bmatrix} = \begin{bmatrix} e_{21} & f_{21} \\ e_{22} & f_{22} \\ e_{23} & f_{23} \end{bmatrix} \begin{bmatrix} \dot{x}_{P_2} \\ \dot{y}_{P_2} \end{bmatrix} \quad (14)$$

334 with $d_i = -(-2l_4 x_{A_i} \sin(\alpha_i) + 2l_4 x_M \sin(\alpha_i) + 2l_4 y_{A_i} \cos(\alpha_i) - 2l_4 y_M \cos(\alpha_i))$,

335 $e_i = -2l_4 \cos(\alpha_i) + 2x_M - 2x_{A_i}$ and $f_i = -2l_4 \sin(\alpha_i) + 2y_M - 2y_{A_i}$ for $i = 1, 2, 3$.

336 The Jacobian matrix of the lower parallel mechanism is thus obtained as follows:

$$\mathbf{J}_2 = (\mathbf{B}_2^{-1} \mathbf{A}_2)^{-1} \quad (15)$$

337 3.2.3. Serial mechanism

338

339 Since the serial mechanism corresponds to an helical joint, the position of the end-effector
 340 in the end-effector reference frame R_e is calculated from the distance traveled by the nut
 341 along the threaded rod. Since the rotation of this rod is controlled by the seventh actuator,
 342 the position of the end-effector E can be expressed as follows:

$$z_{E/R_e} = \frac{p}{2\pi} \alpha_7 \quad (16)$$

343 where p corresponds to the thread pitch of the threaded rod.

344 The angular position of the seventh actuator is determined by inverting this last equation.

345

346 **3.3. Direct and inverse kinematic models of the hybrid interface**

347

348 The direct kinematic model of the hybrid interface is defined by the position and the

349 orientation of the end-effector E (see Fig. 9). The operational vector $\mathbf{X} =$

350 $[x_E \ y_E \ z_E \ \phi_x \ \phi_y \ \phi_z]^T$ is obtained from the DKM of the three mechanisms previously

351 presented such that:

$$\begin{cases} x_E = x_{P_1} + n_E \cdot u_x \\ y_E = y_{P_1} + n_E \cdot u_y \\ z_E = z_{P_1} + n_E \cdot u_z \\ \phi_x = \text{atan2}(z_{P_2} - z_{P_1}, y_{P_2} - y_{P_1}) \\ \phi_y = \text{atan2}(z_{P_2} - z_{P_1}, x_{P_2} - x_{P_1}) \\ \phi_z \end{cases} \quad (17)$$

352 where $n_E = \|\overrightarrow{P_1 P_2}\| - (d + z_{E/R_e})$, d corresponds to the known and fixed distance

353 between the point P_2 and the origin of the end-effector reference frame R_e , $u_x = \frac{x_{P_2} - x_{P_1}}{\|\overrightarrow{P_1 P_2}\|}$,

354 $u_y = \frac{y_{P_2} - y_{P_1}}{\|\overrightarrow{P_1 P_2}\|}$, $u_z = \frac{z_{P_2} - z_{P_1}}{\|\overrightarrow{P_1 P_2}\|}$ and the proper rotation ϕ_z is directly given by the DKM of the

355 lower parallel mechanism.

356

357

358 *Fig. 9 Kinematic representation of the hybrid interface*

359 Concerning the IKM, the coordinates of the end-effectors of the parallel mechanisms can

360 first be calculated knowing that:

$$\begin{cases} \phi_x = \text{atan2}(z_{P_2} - z_{P_1}, y_{P_2} - y_{P_1}) = \text{atan2}(z_{P_2} - z_E, y_{P_2} - y_E) = \text{atan2}(z_E - z_{P_1}, y_E - y_{P_1}) \\ \phi_y = \text{atan2}(z_{P_2} - z_{P_1}, x_{P_2} - x_{P_1}) = \text{atan2}(z_{P_2} - z_E, x_{P_2} - x_E) = \text{atan2}(z_E - z_{P_1}, x_E - x_{P_1}) \end{cases} \quad (18)$$

361 which gives:

$$\begin{cases} x_{P_2} = \frac{z_{P_2} - z_E}{\tan \phi_y} + x_E \\ y_{P_2} = \frac{z_{P_2} - z_E}{\tan \phi_x} + y_E \end{cases} \quad \text{and} \quad \begin{cases} x_{P_1} = \frac{z_{P_1} - z_E}{\tan \phi_y} + x_E \\ y_{P_1} = \frac{z_{P_1} - z_E}{\tan \phi_x} + y_E \end{cases} \quad (19)$$

362 The position of the end-effector along the threaded rod can then be determined by
363 calculating the coordinates of the origin of the end-effector reference frame R_e such that:

$$\mathbf{X}_e = \mathbf{X}_{P_1} + n_e \mathbf{u} \quad (20)$$

364 where $\mathbf{X}_e = [x_e \ y_e \ z_e]^T$, $\mathbf{X}_{P_1} = [x_{P_1} \ y_{P_1} \ z_{P_1}]^T$, $\mathbf{u} = [u_x \ u_y \ u_z]^T$ and $n_e = \|\overrightarrow{P_1 P_2}\| - d$.

365 The norm of the vector \overrightarrow{eE} thus corresponds to the position z_{E/R_e} of the end-effector.

366 Knowing these parameters, the IKM of the complete hybrid interface can thus be obtained
367 using the IKM of each mechanism presented previously, as shown in figure 10.

368

369

370

Fig. 10 Block diagram of the IKM for the complete hybrid interface

371

372

3.4. Choice of working modes

373

374

As mentioned before, the two parallel mechanisms each have 8 different working modes,

375

resulting in 64 possible working modes for the interface. In order to choose the appropriate

376

working modes for both parallel mechanisms, an analysis of the dexterity distribution

377

within the workspace of the two mechanisms was carried out.

378 Dexterity is an index that measures the distance of mechanism from a singularity, i.e. a
 379 configuration in which the mechanism loses or gains a degree of freedom and therefore
 380 becomes uncontrollable.

381 One of the most widely used methods of calculating dexterity is based on the condition
 382 number of the Jacobian matrix [47,48], defined as:

$$\kappa = \|\mathbf{J}\| \cdot \|\mathbf{J}^{-1}\| \quad (21)$$

383 where $\|\mathbf{J}\|$ is the invariant Euclidean norm of the matrix \mathbf{J} .

384 However, the matrix \mathbf{J}_1 of the lower parallel mechanism is non-homogeneous since it has
 385 terms associated with the position and orientation of the end-effector P_1 . This is not the
 386 case with matrix \mathbf{J}_2 , which is only associated with the position of the end-effector P_2 .

387 Before calculating the condition number of matrix \mathbf{J}_1 , the last column of the parallel matrix
 388 \mathbf{A}_1 must thus be divided by a characteristic length L defined according to the orientation of
 389 the mobile platform such that:

$$\begin{cases} L = \sqrt{2} l_3 \sin(\phi_z) & \text{if } \phi_z \neq 0 + k\pi \\ L = \sqrt{2} l_3 & \text{else} \end{cases} \quad (22)$$

390 The condition number varies between 1 and ∞ and dexterity, denoted η , is determined as:

$$\eta = \frac{1}{\kappa} \quad (23)$$

391 The dexterity is then between 0 and 1. A dexterity close to 0 corresponding to a singular
 392 configuration of the mechanism.

393 Figures 11 and 12 show the distribution of dexterity on the workspace of two 3-RRR
 394 mechanisms, with and without a moving platform respectively, depending on the working
 395 mode. To display these results, the two parallel mechanisms were built with a distance of
 396 200 mm between the active revolute joints, the lengths l_1 and l_2 of the legs of each serial

397 chain are equal to 60 mm and 100 mm respectively and the mobile platform of the first
398 mechanism has a radius of 20 mm.

399 For the lower parallel mechanism (see Fig. 11), modes 1 and 8 show maximum dexterity
400 achieved at the center of the mechanism's workspace. Also, unlike the other modes, the
401 high dexterity zone is located around the same central point. The singularities are therefore
402 closer to the boundaries of the workspace than for the other working modes. The same
403 observations can also be made for the upper parallel mechanism (see Fig. 12). At this stage,
404 working modes 1 and 8 have been selected. The final choice between these two modes is
405 made later, based on which will minimize the motor torques according to the desired force
406 feedback.

407

408

409 *Fig. 11 Distribution of dexterity over the entire workspace of the lower parallel mechanism as a function of the*
410 *working mode*

411

412

413 *Fig. 12 Distribution of dexterity over the entire workspace of the lower parallel mechanism as a function of the*
414 *working mode*

415

416 **4. INPUT FORCES AND ACTIVE JOINT TORQUES RELATIONSHIP**

417

418 As mentioned in section 2.2, in the context of teleoperated robotic cervical surgery, it is
419 essential to provide force feedback to the surgeon during each drilling to avoid any risk of
420 undesirable perforation of the bone. In addition, force feedback can be used to create virtual
421 walls to ensure that the interface end-effector remains within the prescribed workspace
422 associated with the task. Moreover, the weight of the interface moving parts can be taken
423 into account to enable gravitational compensation. Consequently, the interface can adjust

424 to counterbalance gravitational forces and maintain its balance, without needing the
425 operator's involvement.

426 In order to enable the interface to provide the desired forces, a relationship has been
427 established between the desired force vector and vector of the torques generated by the
428 interface's active joints. For simplification purposes, the weight of the interface's moving
429 parts has been neglected. Therefore, gravitational compensation of the interface is not
430 implemented in this work.

431 Knowing the desired force feedback vector $\mathbf{F}_{des} =$
432 $[F_{des_x} \ F_{des_y} \ F_{des_z} \ \mathcal{M}_{des_x} \ \mathcal{M}_{des_y} \ \mathcal{M}_{des_z}]$ and the direction of the forces that can be
433 exerted by the parallel and serial mechanisms of the interface, it is possible to determine
434 the torque τ_i that each of the seven motors of the interface must generate.

435 In fact, the parallel mechanisms can only exert forces in the plane (\vec{x}, \vec{y}) , and the serial
436 mechanism can only generate a force along the central axis of the interface connecting
437 points P_1 and P_2 , i.e. the end-effectors of the upper and lower parallel mechanisms
438 respectively (see Fig. 13).

439

440

441 *Fig. 13 Representation of the forces exerted by the parallel and serial mechanisms of the interface*

442 The force vectors exerted by each mechanism expressed in the interface reference frame
443 are thus noted as follow:

$$\begin{cases} \mathbf{F}_{P_1} = [F_{P_{1x}} & F_{P_{1y}} & 0 & 0 & 0 & \mathcal{M}_{P_{1z}}]^T \\ \mathbf{F}_{P_2} = [F_{P_{2x}} & F_{P_{2y}} & 0 & 0 & 0 & 0]^T \\ \mathbf{F}_S = [F_{Sx} & F_{Sy} & F_{Sz} & 0 & 0 & 0]^T \end{cases} \quad (24)$$

444 where \mathbf{F}_S corresponds to the force exerted by the serial mechanism.

445 Firstly, given that the serial mechanism is the only one capable of generating forces along
 446 the \vec{z} axis of the interface reference frame, the z-axis component of the force \mathbf{F}_S can be
 447 expressed as:

$$F_{S_z} = F_{des_z} \quad (25)$$

448 In addition, the components of the force exerted by the serial mechanism can be written as:

$$\mathbf{F}_S = n_u \mathbf{u} \quad (26)$$

449 where $\mathbf{F}_S = [F_{S_x} \ F_{S_y} \ F_{S_z}]^T$, $\mathbf{u} = [u_x \ u_y \ u_z]^T$, $u_x = \frac{x_{P_2} - x_{P_1}}{\|P_1 P_2\|}$, $u_y = \frac{y_{P_2} - y_{P_1}}{\|P_1 P_2\|}$ and $u_z =$
 450 $\frac{z_{P_2} - z_{P_1}}{\|P_1 P_2\|}$ are the components of the unit vector of the force \mathbf{F}_S and x_{P_i} , y_{P_i} and z_{P_i} are the
 451 coordinates of the points P_i known from the direct kinematic model of the parallel
 452 mechanisms presented previously.

453 The value of the coefficient n_u is then determined from the knowledge of the components
 454 F_{S_z} , such as:

$$n_u = \frac{F_{S_z}}{u_z} = \frac{F_{des_z}}{u_z} \quad (27)$$

455 The components along the \vec{x} and \vec{y} axes can then be calculated as:

$$F_{S_x} = \frac{F_{des_z}}{u_z} \times u_x \quad \text{and} \quad F_{S_y} = \frac{F_{des_z}}{u_z} \times u_y \quad (28)$$

456 In the end-effector reference frame R_e , we note:

$$\mathbf{F}_{S/R_e} = [0 \quad 0 \quad F_{S_z/R_e}]^T \quad (29)$$

457 where $F_{S_z/R_e} = \|\mathbf{F}_{S/R_e}\| = \|\mathbf{F}_S\| = \sqrt{F_{S_x}^2 + F_{S_y}^2 + F_{S_z}^2}$.

458 Knowing the thread pitch p of the threaded rod of the serial mechanism, the torque to be
 459 applied is defined as follows:

$$\tau_7 = \frac{p}{2\pi} \times F_{S_z/Re} \quad (30)$$

460 Subsequently, the forces that must be exerted by the parallel mechanisms along the \vec{x} and
461 \vec{y} axes of the interface can be determined:

$$\mathbf{F}_{P_1} + \mathbf{F}_{P_2} + \mathbf{F}_S = \mathbf{F}_{des} = [F_{desx} \quad F_{desy}]^T \quad (31)$$

$$\mathcal{M}_E(\mathbf{F}_{P_1}) + \mathcal{M}_E(\mathbf{F}_{P_2}) + \mathcal{M}_E(\mathbf{F}_S) = \mathcal{M}_{des} = [\mathcal{M}_{desx} \quad \mathcal{M}_{desy}]^T \quad (32)$$

462 Equation (32) gives:

$$\begin{cases} \mathcal{M}_{desx} = (\overline{EP_1} \wedge \mathbf{F}_{P_1})_x + (\overline{EP_2} \wedge \mathbf{F}_{P_2})_x = -z_{EP_1}F_{P_{1y}} - z_{EP_2}F_{P_{2y}} \\ \mathcal{M}_{desy} = (\overline{EP_1} \wedge \mathbf{F}_{P_1})_y + (\overline{EP_2} \wedge \mathbf{F}_{P_2})_y = z_{EP_1}F_{P_{1x}} + z_{EP_2}F_{P_{2x}} \end{cases} \quad (33)$$

463 where $(\overline{EP_1} \wedge \mathbf{F}_{P_1})_x$ corresponds to the x-axis component of the vector product and z_{EP_i} is
464 the component of vector $\overline{EP_i}$ along the \vec{z} axis.

465 The components of the force \mathbf{F}_{P_1} can then be written as follows:

$$\begin{cases} F_{P_{1x}} = \frac{\mathcal{M}_{desy} - z_{EP_2}F_{P_{2x}}}{z_{EP_1}} \\ F_{P_{1y}} = \frac{-\mathcal{M}_{desx} - z_{EP_2}F_{P_{2y}}}{z_{EP_1}} \end{cases} \quad (34)$$

466 Replacing $F_{P_{1x}}$ and $F_{P_{1y}}$ in equation (31) gives:

$$\begin{cases} F_{P_{2x}} = \frac{z_{EP_1}}{z_{EP_1} - z_{EP_2}} \left(F_{desx} - F_{Sx} - \frac{\mathcal{M}_{desy}}{z_{EP_1}} \right) \\ F_{P_{2y}} = \frac{z_{EP_1}}{z_{EP_1} - z_{EP_2}} \left(F_{desy} - F_{Sy} + \frac{\mathcal{M}_{desx}}{z_{EP_1}} \right) \end{cases} \quad (35)$$

467 At this stage, it remains to determine the moment to be exerted by the lower mechanism
468 around the \vec{z} axis in order to generate the desired moment and to compensate for the
469 moments caused by the forces applied by the two parallel mechanisms. Thus, we note:

$$\begin{aligned}
\mathcal{M}_{P_{1z}} &= \mathcal{M}_{des_z} - (\overrightarrow{EP_1} \wedge \mathbf{F}_{P_1})_z - (\overrightarrow{EP_2} \wedge \mathbf{F}_{P_2})_z \\
&= \mathcal{M}_{des_z} - (x_{EP_1}F_{P_{1y}} - y_{EP_1}F_{P_{1x}} + x_{EP_2}F_{P_{2y}} - y_{EP_2}F_{P_{2x}})
\end{aligned} \tag{36}$$

470 Knowing the Jacobian matrices \mathbf{J}_1 and \mathbf{J}_2 , derived from the kinematic models of the parallel
471 mechanisms, the torques of each actuator, numbered from 1 to 3 for the lower mechanism
472 and from 4 to 6 for the upper mechanism, can be calculated such that:

$$\begin{cases} \boldsymbol{\tau}_{1,2,3} = \mathbf{J}_1^T \cdot \mathbf{F}_{P_1} = \mathbf{J}_1^T [F_{P_{1x}} & F_{P_{1y}} & \mathcal{M}_{P_{1z}}]^T \\ \boldsymbol{\tau}_{4,5,6} = \mathbf{J}_2^T \cdot \mathbf{F}_{P_2} = \mathbf{J}_2^T [F_{P_{2x}} & F_{P_{2y}}] \end{cases} \tag{37}$$

473 In summary, the torques to be provided by each actuator are calculated as follows:

$$\begin{cases} \boldsymbol{\tau}_{1,2,3} = \mathbf{J}_1^T \begin{bmatrix} F_{des_x} - F_{P_{2x}} - F_{S_x} \\ F_{des_y} - F_{P_{2y}} - F_{S_y} \\ \mathcal{M}_{des_z} - (x_{EP_1}F_{P_{1y}} - y_{EP_1}F_{P_{1x}} + x_{EP_2}F_{P_{2y}} - y_{EP_2}F_{P_{2x}}) \end{bmatrix} \\ \boldsymbol{\tau}_{4,5,6} = \mathbf{J}_2^T \begin{bmatrix} \frac{z_{EP_1}}{z_{EP_1} - z_{EP_2}} \left(F_{des_x} - F_{S_x} - \frac{\mathcal{M}_{des_y}}{z_{EP_1}} \right) \\ \frac{z_{EP_1}}{z_{EP_1} - z_{EP_2}} \left(F_{des_y} - F_{S_y} - \frac{\mathcal{M}_{des_x}}{z_{EP_1}} \right) \end{bmatrix} \\ \tau_7 = \frac{p}{2\pi} \times F_{S_z/Re} \end{cases} \tag{38}$$

474

475 5. INTERFACE OPTIMIZATION AND DESIGN

476

477 5.1. Optimization problem formulation

478

479 Knowing the specifications that the interface needed to meet in terms of workspace and

480 force feedback, the interface was then optimized. The aim of this optimization is to find

481 the optimal geometric parameters of the interface, defined within a design vector \mathbf{I} , to

482 satisfy a set of criteria and constraints associated with an objective function noted $f(\mathbf{I})$.

483 Once this objective function was defined, an optimization algorithm was used: the genetic

484 algorithm (GA) available in Matlab's *Optimization* toolbox. The GA iteratively searches

485 for the optimal design vector that minimizes the function $f(\mathbf{I})$. Between each iteration, the
 486 algorithm chooses a new design vector to evaluate according to the value interval
 487 $[v_{inf} \ v_{max}]$ chosen for each design variable (i.e. geometric parameter), so that the optimal
 488 solution found belongs to the search interval defined beforehand.

489 The design vector \mathbf{I} is thus composed of seven parameters. Firstly, it contains the x_a
 490 parameter, which defines the position of the actuators of the parallel mechanisms of the
 491 interface. Secondly, the parameter z_m associated with the distance between the parallel
 492 mechanisms, i.e. the dimension of the serial mechanism. Finally, the lengths l_i which
 493 correspond to the dimensions of the legs and mobile platform of the parallel mechanisms
 494 (see Fig. 14).

$$\mathbf{I} = [x_a \ z_m \ l_1 \ l_2 \ l_3 \ l_4 \ l_5] \quad (39)$$

495

496

497 *Fig. 14 Representation of the geometric parameters of the interface*

498 Three criteria are considered for the optimization problem, namely maximizing the
 499 minimum dexterity of the two parallel mechanisms in order to avoid any singularity inside
 500 the workspace, minimizing the motor torques required to generate the desired force
 501 feedback, and minimizing the interface volume. These three criteria, respectively noted
 502 $f_1(\mathbf{I})$, $f_2(\mathbf{I})$ and $f_3(\mathbf{I})$, are formulated as follows:

$$f_1(\mathbf{I}) = 1 - \eta_{min} \quad (40)$$

$$f_2(\mathbf{I}) = \frac{1}{7n_p} \sum_{i=1}^7 \sum_{j=1}^{n_p} \left(\frac{|\tau_{i,j}|}{\tau_{max_i}} \right) \quad (41)$$

$$f_3(\mathbf{I}) = \frac{V_{interface}}{V_{max}} \quad (42)$$

503 where η_{min} is the average of the minimum dexterities of the parallel mechanisms, n_p is
 504 the number of poses constituting the prescribed workspace, $\tau_{i,j}$ is the torque provided by
 505 actuator i associated with pose j of the prescribed workspace, τ_{max_i} is the maximum torque
 506 that can be generated by actuator i , $V_{interface}$ is the volume occupied by the interface
 507 calculated from the parameters x_a and z_m , and V_{max} corresponds to the maximum volume
 508 of the interface that can be obtained from the maximum values chosen for the search
 509 intervals of the parameters x_a and z_m . The three criteria $f_i(\mathbf{I})$ are thus defined to be between
 510 0 and 1. A value close to 0 being associated with high minimum dexterity, low motor
 511 torques and minimal interface volume.

512 In addition, a constraint on the prescribed workspace must be considered to ensure that the
 513 interface can reach any desired end-effector pose. A minimum level of dexterity is also
 514 required to ensure that the interface does not encounter a singularity at any of the
 515 coordinates of the prescribed workspace. A third constraint relates to the motor torque
 516 distribution criterion, which must be between the limit values τ_{max_i} and τ_{min_i} , in order to
 517 guarantee the desired force feedback.

518 A penalty formulation of the optimization problem is considered to handle the previous
 519 constraints. Three penalty functions, denoted p_1 , p_2 and p_3 , have been defined in order to
 520 reject undesirable individuals, i.e. design vectors incompatible with the established
 521 constraints.

522 Thus, the objective function $f(\mathbf{I})$ can be formulated as the sum of the weighted average of
 523 the three criteria f_1 , f_2 and f_3 and the three penalties p_1 , p_2 and p_3 associated respectively

524 with constraints on the workspace, dexterity and the distribution of motor torques such
 525 that:

$$f(\mathbf{I}) = \beta_1 \cdot f_1(\mathbf{I}) + \beta_2 \cdot f_2(\mathbf{I}) + \beta_3 \cdot f_3(\mathbf{I}) + \sum_j (p_{1j} + p_{2j} + p_{3j}) \quad \text{for } j = 1, \dots, n_p \quad (43)$$

526 with:

$$p_{1j} = \begin{cases} 0 & \text{if } \mathbf{P}_j \in \text{interface workspace} \\ \lambda_1 & \text{if } \mathbf{P}_j \notin \text{one of the three mechanisms workspace} \\ 2\lambda_1 & \text{if } \mathbf{P}_j \notin \text{two of the three mechanisms workspaces} \\ 3\lambda_1 & \text{else} \end{cases} \quad (44)$$

$$p_{2j} = \begin{cases} 0 & \text{if } \eta_{min\ sup_j} \geq 0.15 \text{ and } \eta_{min\ inf_j} \geq 0.15 \\ \lambda_2 & \text{else} \end{cases} \quad (45)$$

$$p_{3j} = \begin{cases} 0 & \text{if } \max(\tau_{i,j})_i \leq \tau_{max_m} \text{ and } \min(\tau_{i,j})_i \geq \tau_{min_m} \\ \lambda_3 & \text{else} \end{cases} \quad (46)$$

527 where β_1 , β_2 and β_3 are the weight coefficients of the three criterion functions, n_p is the
 528 number of poses composing the prescribed workspace, $\eta_{min\ sup_j}$ is the minimum dexterity
 529 of the upper parallel mechanism associated with the pose $\mathbf{P}_j (x_j, y_j, z_j, \phi_{x_j}, \phi_{y_j}, \phi_{z_j})$ of the
 530 end-effector, $\eta_{min\ inf_j}$ is the minimum dexterity of the lower parallel mechanism, and λ_1 ,
 531 λ_2 and λ_3 are large-valued scalars.

532 The bounding values, in millimeters, chosen for the design variables are as follows:

$$\begin{aligned} v_{inf} &= [250 \ 200 \ 100 \ 150 \ 20 \ 100 \ 150] \\ v_{max} &= [350 \ 300 \ 200 \ 250 \ 30 \ 200 \ 250] \end{aligned} \quad (47)$$

533

534 **5.2. Optimization results**

535

536 The optimal design vector, denoted \mathbf{I}^* and in millimeters, as a result of the optimization
 537 problem, is obtained by choosing the weighting coefficients $\beta_1 = 0.5$, $\beta_2 = \beta_3 = 0.25$ to

538 favor the maximization of the minimum dexterity over the minimization of the interface
539 volume.

$$\mathbf{I}^* = [320.9 \ 245.6 \ 140.7 \ 196.8 \ 30.0 \ 171.3 \ 187.5] \quad (48)$$

540 The minimal dexterity value within the prescribed workspace for the lower parallel
541 mechanism and for the upper parallel mechanism is equal to 0.17 and 0.19 respectively.

542 *5.2.1. Interface workspace*

543
544 The workspace of the optimized interface is determined from the IKMs previously
545 established. As shown in figure 15, two types of workspace can be distinguished: a
546 translational workspace where the orientation of the end-effector is kept fixed; and a
547 rotational workspace where the initial position of the end-effector is fixed and the end-
548 effector scans the possible range of rotation as well as all the accessible positions along the
549 \vec{z} axis of the end-effector. The translational workspace is thus linked to the tool positioning
550 phase at the desired drilling entry point (see Fig. 3a). While the rotational workspace is
551 associated with drilling execution, i.e. the prescribed cone-shaped workspace (see Fig. 3b
552 and 3c).

553 Figure 15a shows the translational workspace obtained when the end-effector is held
554 vertically and for an orientation of 90° of the mobile platform of the lower parallel
555 mechanism. In addition, figure 15b shows two rotational workspaces constructed from two
556 different initial positions of the interface end-effector.

557

558

559 *Fig. 15 (a) Translational workspace with fixed end-effector orientation equal to 90° and (b) rotational workspaces of*
560 *the interface around the drilling entry point with coordinates [160.5 92.6 100] mm in blue and [125 175 90] mm in*
561 *orange*

562

563 5.2.2. *Motor torque distribution*

564

565 The torques to be generated by each actuator were computed over the entire prescribed
 566 workspace. Figure 16 shows the results obtained for a desired force feedback vector $\mathbf{F}_{des} =$
 567 $[10 \ -10 \ 30 \ -0.5 \ -0.5 \ 0.5]$ N and N.m corresponding to the critical force feedback
 568 generating the highest torques. The torque values for each actuator for the configurations
 569 with the highest and lowest dexterity values for the two parallel mechanisms are shown
 570 with green and red lines respectively. The corresponding configurations are shown on
 571 figures 16a and 16b.

572

573 *Fig. 16 Distribution of motor torques generated by each actuator for the configurations where the dexterity values of*
 574 *the parallel mechanisms are (a) the highest and (b) the lowest*

575 These results were obtained by selecting working mode 1 for the two parallel mechanisms
 576 since it minimised the motor torques required for the same force feedback compared with
 577 working mode 8.

578

579 **5.3. Design of a motorized prototype**

580

581 Following the optimization, a motorized prototype of the interface was designed taking
 582 into account the optimal geometric dimensions obtained (see Fig. 17).

583 For actuation, Simplex SC040 servomotors will be used for the parallel mechanisms and a

584 Simplex SE010 servomotor will be used to control the serial mechanism of the interface

585 [49]. Knowing the maximum torques that these servomotors can provide, 0.8 N.m and 0.4

586 N.m respectively, capstans were added to the design for the parallel mechanisms so that

587 the interface can generate the desired force feedback (see Fig. 16). The output torque of the

588 actuators of the parallel mechanisms will thus be multiplied by the ratio of the diameter of

589 the capstan to the diameter of the driving pulley, fixed on the axis of the considered
590 actuator.

591 Since the motor 1 of the lower parallel mechanism must provide a maximum torque of 6.2
592 N.m in order to ensure the desired force feedback associated with the drilling task, a radius
593 of 80.5 mm was chosen for the capstans of the lower mechanism. The radius of the drive
594 pulleys being 9.45 mm, the reduction ratio is thus approximately equal to 8.5.

595 For the upper parallel mechanism, a maximum torque of 0.9 N is achieved for motor 5. A
596 reduction ratio of 1.125 would therefore be sufficient to enable the motor to deliver the
597 required torque. However, for manufacture reasons, the upper capstans have been
598 oversized by choosing a radius of 40 mm, giving a reduction ratio of approximately 4.2.

599 Concerning the serial mechanism, the maximum torque that the motor can deliver is much
600 higher than the maximum torque required, validating the choice of the motor. In addition,
601 a threaded rod with a diameter of 5 mm and a thread pitch equal to 10 mm was chosen in
602 order to generate a reversible translation of the nut linked to the end-effector of the
603 interface.

604 Finally, since the main disadvantage of hybrid mechanisms is friction, ball bearings and
605 self-lubricating bronze bushings are used to cope with this issue. Tight dimensional and
606 geometric tolerances also contribute to minimize friction.

607

608

609 *Fig. 17 Design of the motorized interface prototype*

610

611 **6. CONCLUSION AND FUTURE WORK**

612

613 This paper presented a 6-DoF hybrid interface dedicated to teleoperated cervical spine
614 surgery. The proposed architecture consists of two parallel mechanisms controlling the
615 position and orientation of a central rod on which a serial mechanism is mounted to control
616 linear translation. In the context of posterior cervical arthrodesis, the association of the
617 parallel and serial mechanisms will allow to fix the CoR as well as the orientation of the
618 central rod, linked to the entry point and the orientation of the drilling. In addition, the
619 serial mechanism, which can be decoupled from the other mechanisms, will control the
620 drilling tool advance along the selected drilling axis, thus meeting the expectations of the
621 cervical drilling task. In addition to the geometry of the surgical task, coupled with the
622 definition of the prescribed workspace covered by the interface, realistic force feedback
623 must be provided to the surgeon to identify in which bone zone the drilling is taking place,
624 cortical or cancellous, thus avoiding any undesirable perforation of the bone.

625 After solving the direct and inverse kinematic models of the entire hybrid interface and
626 establishing the relationship between input forces and active joint torques, the design
627 parameters of the interface were optimized within three criteria. The first criterion was the
628 dexterity distribution within the prescribed workspace to avoid singularities. The second
629 criterion was the motor torques distribution with the aim of minimization. Finally, the final
630 objective was to reduce the interface volume. After obtaining the optimal design vector, a
631 motorized prototype was designed.

632 Future work will consist of assembling this prototype and implementing its control. This
633 task should allow, on the one hand, the retrieval of the end-effector pose from the interface,
634 which will then be sent as a setpoint to a robot, and, on the other hand, the generation of
635 force feedback at the interface, which will be associated with the interaction forces exerted

636 between the robot and the external environment. This will lead to an experimental
637 validation of the interface through the control of a robotic arm in a teleoperation scheme.

638

639 **ACKNOWLEDGMENT**

640

641 This work was supported by the University of Poitiers and by the CNRS through the
642 International Research Project *RACeS*.

643

644 **FUNDING**

645

- University of Poitiers

646

- CNRS, the French National Centre for Scientific Research, through the

647

International Research Project *RACeS* (Robotic Assisted System for Safe Cervical

648

Surgery) (TWN-IRP-17).²

649

² <https://irp-races.prd.fr/>

650 **NOMENCLATURE**

651

$(x, y)_{A_i}$	coordinates of points A_i corresponding to the active revolute joints of the parallel mechanisms
$(x, y)_{B_i}$	coordinates of point B_i corresponding to the first passive revolute joints of the parallel mechanisms
$(x, y)_{C_i}$	coordinates of point C_i corresponding to the vertex of the mobile platform of the lower parallel mechanism
$(x, y)_{P_1}$	coordinates of the end-effector P_1 of the lower parallel mechanism
$(x, y)_{P_2}$	coordinates of the end-effector P_2 of the upper parallel mechanism
\mathbf{x}	operational vector resulting from the DKM of the interface
$(x, y, z)_E$	coordinates of the end-effector E of the serial mechanism and the interface
$\phi_{(x,y,z)}$	orientation of the end-effector of the interface
l_1	length of the first legs of the serial branches of the lower parallel mechanism
l_2	length of the second legs of the serial branches of the lower parallel mechanism
l_3	radius of the mobile platform
l_4	length of the first legs of the serial branches of the upper parallel mechanism

l_5	length of the second legs of the serial branches of the upper parallel mechanism
α_i	joint position of the actuator i of the interface
ε_i	angle provide by the sensor i
γ_i	angle locating the vertex i of the mobile platform
θ_i	angle between the \vec{x} axis of the base reference frame R_O and the segment $[A_i P_2]$ of the upper parallel mechanism
σ_i	coefficient equal to 1 or -1 depending on the working mode of the 3-RRR mechanism
$(\dot{x}, \dot{y})_{P_1}$	Cartesian velocities of the end-effector P_1 of the lower parallel mechanism
$\dot{\phi}_z$	rotation velocity of the mobile platform
\mathbf{A}_1	parallel Jacobian matrix of the lower parallel mechanism
\mathbf{B}_1	serial Jacobian matrix of the lower parallel mechanism
\mathbf{J}_1	Jacobian matrix of the lower parallel mechanism
$(\dot{x}, \dot{y})_{P_2}$	Cartesian velocities of the end-effector P_2 of the upper parallel mechanism
\mathbf{A}_2	parallel Jacobian matrix of the upper parallel mechanism
\mathbf{B}_2	serial Jacobian matrix of the upper parallel mechanism
\mathbf{J}_2	Jacobian matrix of the upper parallel mechanism

z^E/R_e	position of the end-effector of the serial mechanism in the end-effector reference frame R_e
p	thread pitch of the threaded rod of the serial mechanism
d	distance between the point P_2 and the origin of the end-effector reference frame R_e
n_E	distance between the point P_1 and the end-effector E of the interface
$u_{(x,y,z)}$	components of the direction vector of the segment $[P_1 P_2]$
n_e	distance between the point P_1 and the origin e of the end-effector reference frame R_e
κ	condition number of the Jacobian matrix
η	dexterity index
\mathbf{F}_{des}	desired force feedback vector
$F_{des(x,y,z)}$	components of the desired force
$\mathcal{M}_{des(x,y,z)}$	components of the desired moments
τ_i	torque generated by the actuator i of the interface
\mathbf{F}_{P_1}	force vector exerted by the lower parallel mechanism
$F_{P_1(x,y)}$	components of the force exerted by the lower parallel mechanism
\mathcal{M}_{P_1z}	components of the moment exerted by the lower parallel mechanism
\mathbf{F}_{P_2}	force vector exerted by the upper parallel mechanism

$F_{P_2(x,y)}$	components of the force exerted by the upper parallel mechanism
\mathbf{F}_S	force vector exerted by the serial mechanism
$F_{S(x,y,z)}$	components of the force exerted by the serial mechanism
n_u	coefficient of proportionality between the component of the force \mathbf{F}_S and the component of the direction vector of the segment $[P_1 P_2]$
\mathbf{F}_{S/R_e}	force vector exerted by the serial mechanism expressed in the end-effector reference frame R_e
$\mathcal{M}_E(\mathbf{F})$	moment of a force \mathbf{F} about point E
$(x, y, z)_{EP_i}$	components of vector $\overrightarrow{EP_i}$
\mathbf{I}	design vector of the interface
x_a	parameter associated with the position of the actuators of the parallel mechanism of the interface
z_m	distance between the parallel mechanisms
$f_i(\mathbf{I})$	criterion function i for optimization
η_{min}	average of the minimum dexterities of the parallel mechanisms
n_p	number of poses constituting the prescribed workspace
$\tau_{i,j}$	torque provided by actuator i associated with pose j of the prescribed workspace
τ_{max_i}	maximum torque that can be generated by actuator i
$V_{interface}$	volume occupied by the interface

V_{max}	maximum volume of the interface obtained from the maximum values chosen for the parameters x_a and z_m
β_i	weight coefficients of the three criterion functions
p_i	penalty i associated with constraints on the workspace, dexterity and the distribution of motor torques
v_{inf}	minimum bounding values for the design variables
v_{max}	maximum bounding values for the design variables
\mathbf{I}^*	optimal design vector of the interface

653 **REFERENCES**

654

655 [1] Farooq Usmani, M., Gopinath, R., Camacho, J. E., Gentry, R., and Ludwig, S. C., 2020,
656 "Management of cranio-cervical injuries: C1-C2 posterior cervical fusion and
657 decompression," *Seminars in Spine Surgery*, **32**(1). DOI: 10.1016/j.semss.2019.100782

658

659 [2] Molligaj, G, Paun, L., Nouri, A., Girod, P.-P., Schaller, K., and Tessitore, E., 2020, "Role
660 of robotics in improving surgical outcome in spinal pathologies," *World Neurosurgery* **140**,
661 pp. 664-673. DOI: 10.1016/j.wneu.2020.05.132

662

663 [3] Avrumova, F., Sivaganesan, A., Alluri, R. K., Vaishnav, A., Qureshi, S., and Lebl, D. R.,
664 2021, "Work-flow and efficiency of robotic-assisted navigation in spine surgery," *HSS J.*
665 **17**(3), pp. 302-307. DOI: 10.1177/15563316211026658

666

667 [4] Koszulinski, A., Sandoval, J., Vendevre, T., Zeghloul, S., and Laribi, M. A., 2022,
668 "Comanipulation Robotic Platform for Spine Surgery with Exteroceptive Visual Coupling:
669 Development and Experimentation," *ASME Journal of Medical Devices*, **16**(4), pp.
670 041002_1-11. DOI: 10.1115/1.4054550

671

672 [5] Koszulinski, A., Sandoval, J., and Laribi, M. A., 2023, "Design and modelisation of a 6
673 degrees of freedom interface with repositionable centre of rotation. *New Advances in*
674 *Mechanisms, Transmissions and Applications*," *MeTrApp 2023, Mechanisms and Machine*
675 *Science*, eds., Springer, Cham, **124**, pp. 286-296. DOI: 10.1007/978-3-031-29815-8_28

676

677 [6] Ewerton, M., Rother, D., Weimar, J., Kollegger, G., Wiemeyer, J., Peters, J., and Maeda,
678 G., 2018, "Assisting Movement Training and Execution With Visual and Haptic Device,"
679 *Frontiers in Neurorobotics*, **12**, pp. 12-24. DOI: 10.3389/fnbot.2018.00024

680

681 [7] Rhienmora, P., Haddawy, P., Dailey, M., Khanal, P., and Suebnukarn, S., 2008,
682 "Development of a Dental Skills Training Simulator Using Virtual Reality and Haptic
683 Device," *NECTEC Technical Journal*, **8**(20), pp. 140-147. DOI:

684

685 [8] Gautreau, E., Sandoval, J., Thomas, A., Guilhem, J.-M., Carbone, G., Zeghloul, S., and
686 Laribi, M. A., 2022, "Redundancy Exploitation of an 8-DoF Robotic Assistant for Doppler
687 Sonography," *Actuators*, **11**(2), pp. 33. DOI: 10.3390/act11020033

688

689 [9] Abeywardena, S., and Chen, C., 2017, "Implementation and evaluation of a three-
690 legged six-degrees-of-freedom parallel mechanism as an impedance-type haptic device,"
691 *IEEE/ASME Transactions on Mechatronics*, **22**(3), pp. 1412-1422. DOI:
692 10.1109/TMECH.2017.2682930

693

694 [10] Meskini, M., Saafi, H., Mlika, A., Arsicault, M., Zeghloul, S., and Laribi, M. A., 2023,
695 "Development of a novel hybrid haptic (nHH) device with a remote center of rotation

- 696 dedicated to laparoscopic surgery," *Robotica*, **41**(10), pp. 3175-3194. DOI:
697 10.1017/S0263574723000942
- 698
- 699 [11] Goel, A., Desai, K. I., and Muzumdar, D., P., 2002, "Atlantoaxial fixation using plate
700 and screw method: a report of 160 treated patients, " *Neurosurgery*, **51**(6), pp. 1351-
701 1357. DOI: 10.1227/01.NEU.0000035852.23082.C6
- 702
- 703 [12] Simsek, S., Yigitkanli, K., Seçkin, H., Comert, A., Acar, H. I., Belen, D., Tekdemir, I., and
704 Elhan, A., 2009, "Ideal screw entry point and projection angles for posterior lateral mass
705 fixation of the atlas: an anatomical study," *European Spine Journal*, **18**(9), pp. 1321-1325.
706 DOI: 10.1007/s00586-009-1105-7
- 707
- 708 [13] Merola, A. A., Castro, B. A., Alongi, P. R., Mathur, S., Brkaric, M., Vigna, F., Riina, J. P.,
709 Gorup, J., and Haheer, T., 2002, "Anatomic consideration for standard and modified
710 techniques of cervical lateral mass screw placement," *The spine journal: official journal of*
711 *the North American Spine Society*, **2**(6), pp. 430-435. DOI: 10.1016/S1529-
712 9430(02)00461-8
- 713
- 714 [14] Abdullah, K. G., Nowacki, A. S., Steinmetz, M. P., Wang, J. C., and Mroz, T. E., 2011,
715 "Factors affecting lateral mass screw placement at C-7: Clinical article," *Journal of*
716 *neurosurgery, Spine*, **14**(3), pp. 405-411. DOI: 10.3171/2010.11.SPINE09776
- 717
- 718 [15] Ebraheim, N. A., Treamins, M. R., Xu, R., and Yeasting, R. A., 1998, "Lateral radiologic
719 evaluation of lateral mass screw placement in the cervical spine," *Spine*, **23**(4), pp. 458-
720 462. DOI: 10.1097/00007632-199802150-00010
- 721
- 722 [16] Xu, R., Ebraheim, N. A., Klausner, T., and Yeasting, R. A., 1998, "Modified Magerl
723 technique of lateral mass screw placement in the lower cervical spine: an anatomic
724 study," *Journal of Spinal Disorders*, **11**(3), pp. 237-240. DOI: 10.1097/00002517-
725 199806000-00011
- 726
- 727 [17] Liu, G., Xu, R., Ma, W., Sun, S., and Feng, J., 2011, "Anatomical considerations for the
728 placement of cervical transarticular screws: Laboratory investigation," *Journal of*
729 *neurosurgery, Spine*, **14**(1), pp. 114-121. DOI: 10.3171/2010.9.SPINE1066
- 730
- 731 [18] Senoglu, M., Safavi-Abbasi, S., Theodore, N., Crawford, N. R., and Sonntag, V. K. H.,
732 2010, "Feasible and accurate occipitoatlantal transarticular fixation: an anatomic study,"
733 *Neurosurgery*, **66**(3), pp. 173-177. DOI: 10.1227/01.NEU.0000350982.03929.05
- 734
- 735 [20] Xu, R., Zhao, L., Chai, B., Ma, W., Xia, H., Wang, G., and Jiang, W., 2009, "Lateral
736 radiological evaluation of transarticular screw placement in the lower cervical spine,"
737 *European Spine Journal*, **18**(3), pp. 392-397. DOI: 10.1007/s00586-008-0861-0
- 738

- 739 [21] Lee, K. M., Yeom, J. S., Lee, J. O., Buchowski, J. M., Park, K.-W., Chang, B.-S., Lee, C.-
740 K., and Riew, K. D., 2010, "Optimal trajectory for the atlantooccipital transarticular screw,"
741 *Spine*, **35**(16), pp. 1562-1570. DOI: 10.1097/BRS.0b013e3181c15a84
742
- 743 [22] Zhao, L., Xu, R., Liu, J., Sochacki, K. R., Ma, W., Jiang, W., Liu, G., Cao, J., and Hua, Q.,
744 2012, "The study on comparison of 3 techniques for transarticular screw placement in the
745 lower cervical spine," *Spine*, **37**(8), pp. 468-472. DOI: 10.1097/BRS.0b013e318237aae4
746
- 747 [23] Cassinelli, E. H., Lee, M., Skalak, A., Ahn, N. U., and Wright, N. M., 2006, "Anatomic
748 considerations for the placement of C2 laminar screws," *Spine*, **31**(24), pp. 2767-2771.
749 DOI: 10.1097/01.brs.0000245869.85276.f4
750
- 751 [24] Ma, X.-Y., Yin, Q.-S., Wu, Z.-H., Xia, H., Riew, K. D., and Liu, J.-F., 2010, "C2 anatomy
752 and dimensions relative to translaminar screw placement in an Asian population," *Spine*,
753 **35**(6), pp. 704-708. DOI: 10.1097/BRS.0b013e3181bb8831
754
- 755 [25] Saetia, K., and Phankhongsab, A., 2014, "C2 anatomy for translaminar screw
756 placement based on computerized tomographic measurements," *Asian Spine Journal*,
757 **9**(2), pp. 205-209. DOI: 10.4184/asj.2015.9.2.205
758
- 759 [26] Wang, M. Y., 2006, "C2 crossing laminar screws: cadaveric morphometric analysis,"
760 *Neurosurgery*, **59**(1), pp. 84-88. DOI: 10.1227/01.NEU.0000219900.24467.32
761
- 762 [27] Ji, W., Liu, X., Huang, W., Huang, Z., Li, X., Chen, J., Wu, Z., and Zhu, Q., 2015,
763 "Feasibility of C2 Vertebra Screws Placement in Patient With Occipitalization of Atlas: A
764 Tomographic Study," *Medicine*, **94**(7), pp. 1492. DOI: 10.1097/MD.0000000000001492
765
- 766 [28] Yue, B., Kwak, D.-S., Kim, M.-K., Kwon, S.-O., and Han, S.-H., 2010, "Morphometric
767 trajectory analysis for the C2 crossing laminar screw technique," *European Spine Journal*,
768 **19**(5), pp. 828-832. DOI: 10.1007/s00586-010-1331-z
769
- 770 [29] Kong, G., Ji, W., Huang, Z., Liu, J., Chan, J., and Zhu, Q., 2017, "The risk of translaminar
771 screw fixation to the transverse foramen of the lower cervical spine: a computed
772 tomography study," *Scientific Reports*, **7**(1), pp. 46611. DOI: 10.1038/srep46611
773
- 774 [30] Tan, K.-A., Lin, S., Chin, B. Z., Thadani, V. N., Hey, H. W. D., 2020, "Anatomic
775 techniques for cervical pedicle screw placement," *Journal of Spine Surgery*, **6**(1), pp. 262-
776 273. DOI: 10.21037/jss.2020.03.07
777
- 778 [31] Faghih-Jouibari, M., Moazzeni, K., Amini-Navai, A., Hanaei, S., Abdollahzadeh, S., and
779 Khanmohammadi, R., 2016, "Anatomical considerations for insertion of pedicular screw
780 in cervicothoracic junction," *Iranian Journal of Neurosurgery*, **15**(4), pp. 228-231.
781

- 782 [32] Abumi, K., 2015, "Cervical spondylotic myelopathy: posterior decompression and
783 pedicle screw fixation," *European Spine Journal*, **24**(2), pp. 186-196. DOI:
784 10.1007/s00586-015-3838-9
785
- 786 [33] Abumi, K., Itoh, H., Taneichi, H., and Kaneda, K., 1994, "Transpedicular screw fixation
787 for traumatic lesions of the middle and lower cervical spine," *Journal of Spinal Disorders*,
788 **7**(1), pp. 19-28. DOI: 10.1097/00002517-199407010-00003
789
- 790 [34] Yoon, S.-D., Lee, J. Y., Lee, I-S., Moon, S. M., Cho, B. M., Park, S.-H., and Oh, S.-M.,
791 2013, "Cervical pedicle screw placement in sawbone models and unstable cervical
792 traumatic lesions by using para-articular mini-laminotomy: a novice neurosurgeon's
793 experience," *Korean Journal of Neurotrauma*, **9**(2), pp. 106-113. DOI:
794 10.13004/kjnt.2013.9.2.106
795
- 796 [35] Panjabi, M. M., Duranceau, J., Goel, V., Oxland, T., and Takata, K., 1990, "Cervical
797 human vertebrae quantitative three-dimensional anatomy of the middle and lower
798 regions," *Spine*, **16**(8), pp. 861-869. DOI: 10.1097/00007632-199108000-00001
799
- 800 [36] Richter, M., Cakir, B., Schmidt, R., 2005, "Cervical pedicle screws: conventional versus
801 computer-assisted placement of cannulated screws," *Spine*, **30**(20), pp. 2280-2287. DOI:
802 10.1097/01.brs.0000182275.31425.cd
803
- 804 [37] Tian, W., Han, X., Liu, B., Liu, Y., Hu, Y., Han, X., Xu, Y., Fan, M., and Jin, H., 2013, "A
805 robot-assisted surgical system using a force-image control method for pedicle screw
806 insertion," *PLoS ONE*, **9**(1). DOI: 10.1371/journal.pone.0086346
807
- 808 [38] Wolf, A., Shoham, M., Michael, S., and Moshe, R., 2004, "Feasibility study of a mini,
809 bone-attached, robotic system for spinal operations," *Spine*, **29**(2), pp. 220-228. DOI:
810 10.1097/01.BRS.0000107222.84732.DD
811
- 812 [39] Matsumiya, K., Momoi, Y., Kobayashi, E., Sugano, N., Yonenobu, K., Inada, H., Tsuji,
813 T., and Sakuma, I., 2003, "Forces and torques during robotic needle insertion to human
814 vertebra," *International Congress Series*, **1256**, pp. 492-497. DOI: 10.1016/S0531-
815 5131(03)00472-2
816
- 817 [40] Wolf, A., Shoham, M., Michael, S., and Moshe, R., 2001, "Morphometric study of the
818 human lumbar spine for operation-workspace specifications," *Spine*, **26**(22), pp. 2472-
819 2477. DOI: 10.1097/00007632-2001111150-00015
820
- 821 [41] Rezazadeh, S., Bai, W., Sun, M., Chan, S., Lin, Y., and Cao, Q., 2019, "Robotic spinal
822 surgery system with force feedback for teleoperated drilling," *The Journal of Engineering*,
823 **2019**(14), pp. 500-505. DOI: 10.1049/joe.2018.9407
824

- 825 [42] Jin, H., Hu, Y., Tian, W., Zhang, P., Zhang, J., and Li, B., 2014, "Safety analysis and
826 control of a robotic spinal surgical system," *Mechatronics*, **24**(1), pp. 55-65. DOI:
827 10.1016/j.mechatronics.2013.11.008
828
- 829 [43] Hu, Y., Jin, H., Zhang, L., Zhang, P., Zhang, J., 2014, "State recognition of pedicle
830 drilling with force sensing in a robotic spinal surgical system," *IEEE/ASME Transactions of*
831 *Mechatronics*, **19**(1), pp. 357-365. DOI: 10.1109/TMECH.2012.2237179
832
- 833 [44] Powers, M. J., 2006, "The mechanics of bone drilling: experiment and finite element
834 predictions," Ph.D. thesis, University of Calgary, Calgary, Alberta, Canada.
835
- 836 [45] Gosselin, C. M., Sefrioui, J., and Richard, M. J., 1992, "Solutions polynomiales au
837 problème de la cinématique directe des manipulateurs parallèles plans à trois degrés de
838 liberté," *Mechanism and Machine Theory*, **27**(2), pp. 107-119. DOI: 10.1016/0094-
839 114X(92)90001-X
840
- 841 [46] Merlet, J.-P., 1993, "Algebraic-Geometry Tools for the Study of Kinematics of Parallel
842 Manipulators," *Computational Kinematics*, **28**, pp. 183-194. DOI: 10.1007/978-94-015-
843 8192-9_17
844
- 845 [47] Alba-Gomez, O., Wenger, P., and Pamanes, 2005, "Consistent Kinetostatic Indices for
846 Planar3-DOF Parallel Manipulators, Application to the Optimal Kinematic Inversion,"
847 *Proceedings of the ASME 2005 International Design Engineering Technical Conferences*
848 *and Computers and Information in Engineering Conference*. Volume 7: 29th Mechanisms
849 and Robotics Conference, Parts A and B, **7**, pp. 765-774. DOI: 10.1115/DETC2005-84326
850
- 851 [48] Quintero-Riaza, H. F., Mejía-Calderón, L. A., and Díaz-Rodríguez, M., 2019, "Synthesis
852 of planar parallel manipulators including dexterity, force transmission and stiffness
853 index," *Mechanics Based Design of Structures and Machines*, **47**(6), pp. 680-702.
854 DOI:10.1080/15397734.2019.1615503
855
- 856 [49] Simplex motion, Integrated Servomotors, [https://simplexmotion.com/integrated-](https://simplexmotion.com/integrated-servomotors/se-series/)
857 [servomotors/se-series/](https://simplexmotion.com/integrated-servomotors/se-series/), last access 15/10/2023
858

859
860

Figure Captions List

- Fig. 1 Illustration of posterior cervical arthrodesis
- Fig. 2 (a) Virtuouse 6D by Haption, (b) Omega 3 parallel interface by Force Dimension, (C) MEPaM developed by Abeywardena *et al.* and (d) Hybrid interface developed by Meskini *et al.*
- Fig. 3 Illustration of the drilling procedure and the prescribed workspaces
- Fig. 4 Summary of the results of the literature review conducted on the drilling parameters of five different drilling gestures
- Fig. 5 (a) Typical curve of the evolution of the force applied along the drilling axis and (b) histograms of the maximum values of force and moment found in the literature
- Fig. 6 Representation of the interface architecture and the degrees of freedom obtain with each mechanism: (a) the upper mechanism, (b) the lower mechanism, (c) the assembly of the two parallel mechanisms and (d) the serial mechanism
- Fig. 7 Kinematic representation of (a) the lower parallel mechanism and (b) its mobile platform
- Fig. 8 Kinematic representation of the upper parallel mechanism
- Fig. 9 Kinematic representation of the hybrid interface
- Fig. 10 Block diagram of the IKM for the complete hybrid interface

- Fig. 11 Distribution of dexterity over the entire workspace of the lower parallel mechanism as a function of the working mode
- Fig.12 Distribution of dexterity over the entire workspace of the lower parallel mechanism as a function of the working mode
- Fig. 13 Representation of the forces exerted by the parallel and serial mechanisms of the interface
- Fig. 14 Representation of the geometric parameters of the interface
- Fig. 15 (a) Translational workspace with fixed end-effector orientation equal to 90° and (b) rotational workspaces of the interface around the drilling entry point with coordinates [160.5 92.6 100] mm in blue and [125 175 90] mm in orange
- Fig. 16 Distribution of motor torques generated by each actuator for the configurations where the dexterity values of the parallel mechanisms are (a) the highest and (b) the lowest
- Fig. 17 Design of the motorized interface prototype

861

862

863
864

Table Caption List

Table 1	Main advantages and disadvantages of the rigid-link interface classes
Table 2	Possible working modes of the 3-RRR parallel mechanism

865
866

867
868

Figure 1: Illustration of posterior cervical arthrodesis

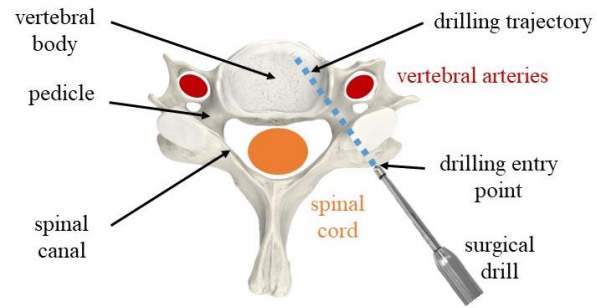

869
870

871
872
873
874
875

Figure 2: (a) Virtuose 6D by Haption, (b) Omega 3 parallel interface by Force Dimension, (c) MEPaM developed by Abeywardena *et al.* and (d) Hybrid interface developed by Meskini *et al.*

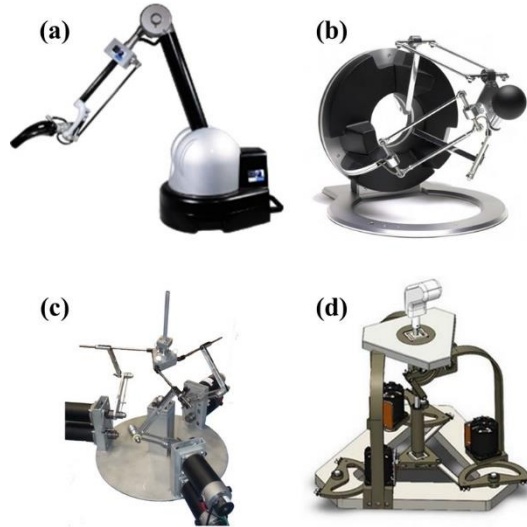

876
877

878
879

Figure 3: Illustration of the drilling procedure and the prescribed workspaces

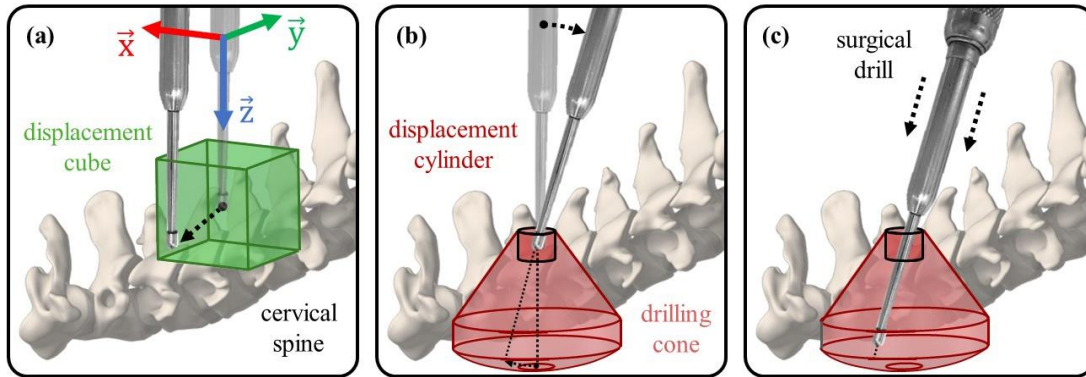

880
881

882
883
884

Figure 4: Summary of the results of the literature review conducted on the drilling parameters of five different drilling gestures

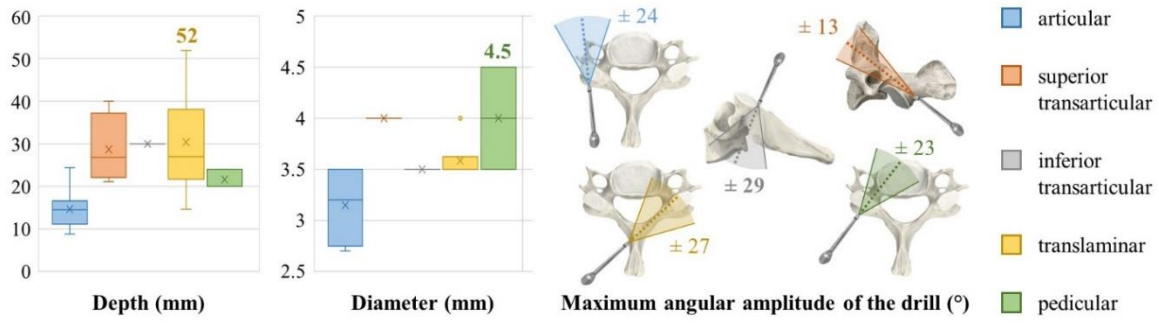

885
886

887
888
889
890

Figure 5: (a) Typical curve of the evolution of the force applied along the drilling axis and (b) histograms of the maximum values of force and moment found in the literature

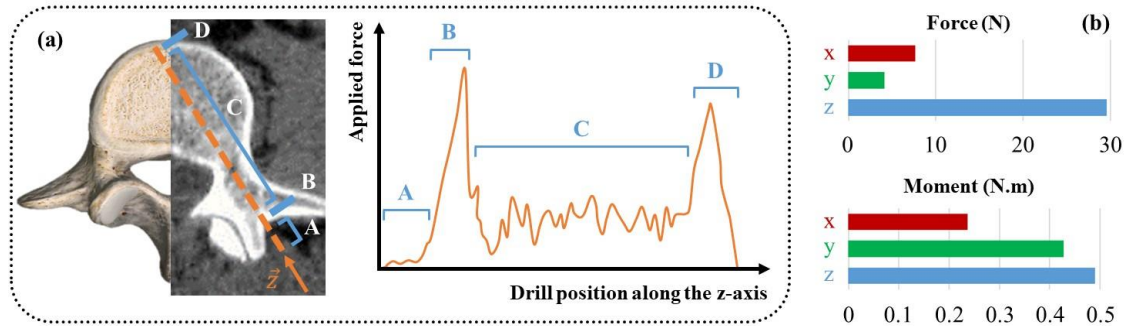

891
892

893 **Figure 6: Representation of the interface architecture and the degrees of freedom**
894 **obtain with each mechanism: (a) the upper mechanism, (b) the lower mechanism, (c)**
895 **the assembly of the two parallel mechanisms and (d) the serial mechanism**
896

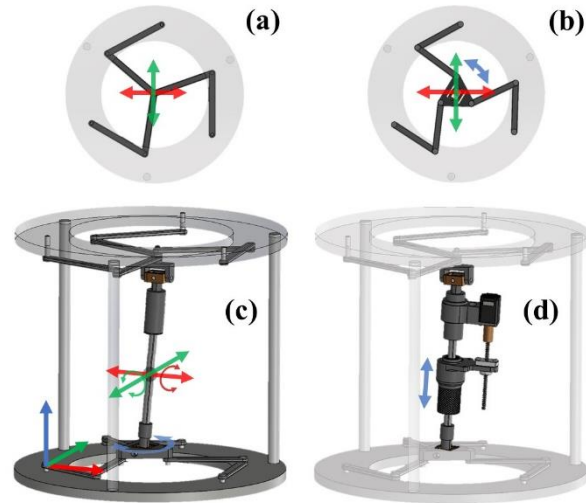

897
898

899
900
901

Figure 7: Kinematic representation of (a) the lower parallel mechanism and (b) its mobile platform

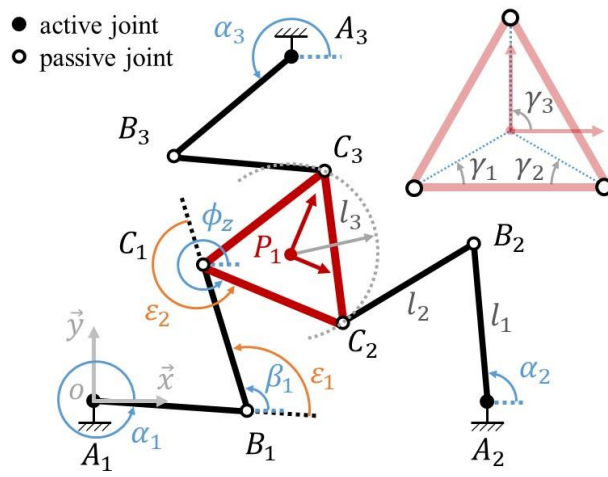

902
903

904
905

Figure 8: Kinematic representation of the upper parallel mechanism

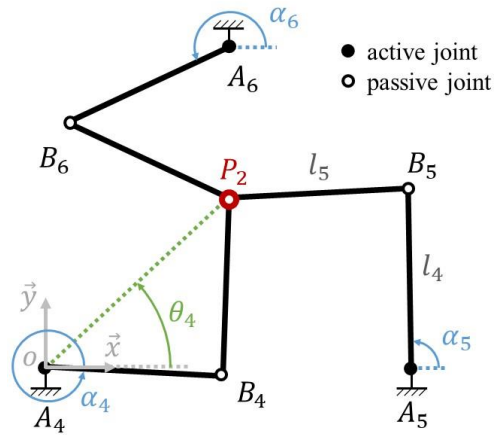

906
907

908
909

Figure 9: Kinematic representation of the hybrid interface

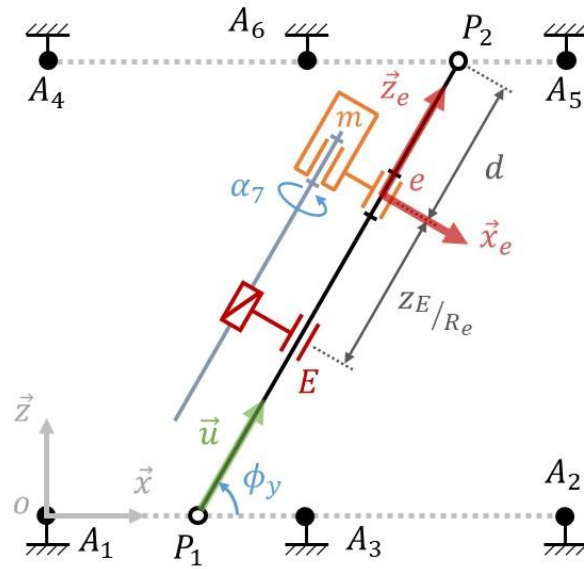

910
911

912
913

Figure 10: Block diagram of the IKM for the complete hybrid interface

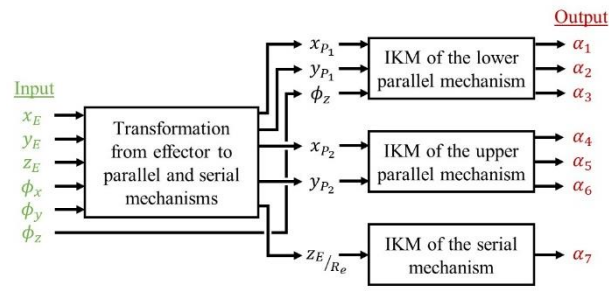

914
915

916
917
918

Figure 11: Distribution of dexterity over the entire workspace of the lower parallel mechanism as a function of the working mode

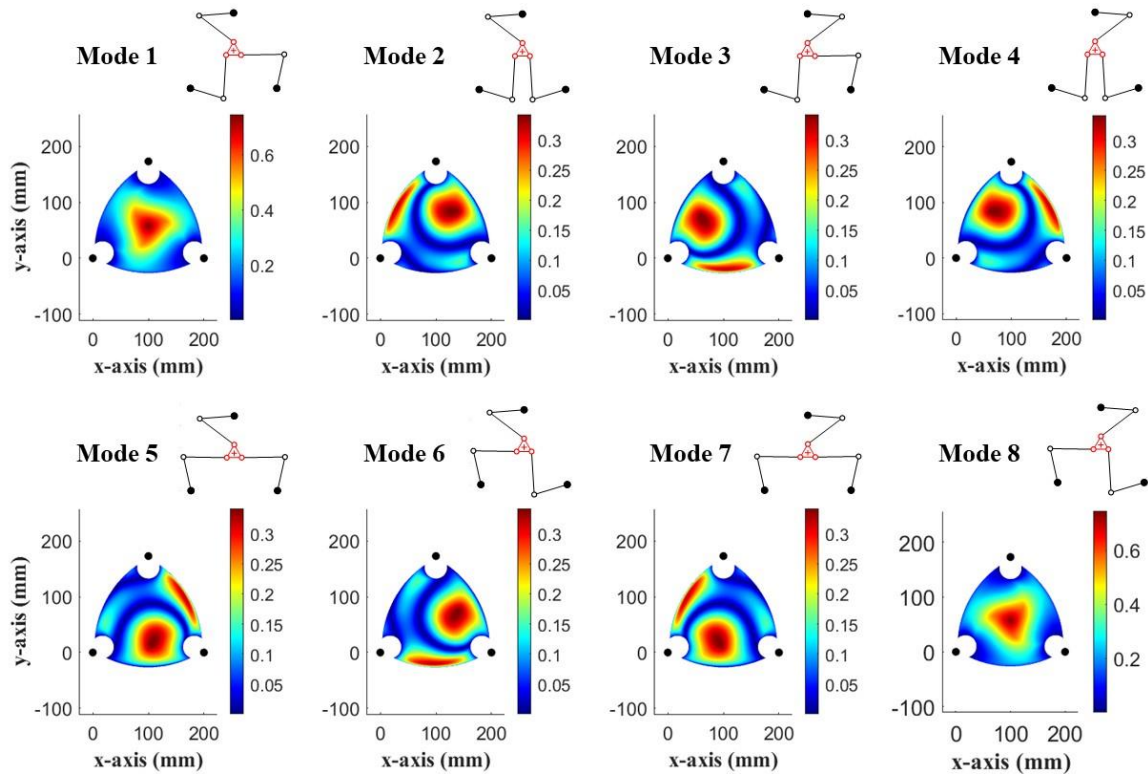

919
920

921
922
923

Figure 12: Distribution of dexterity over the entire workspace of the lower parallel mechanism as a function of the working mode

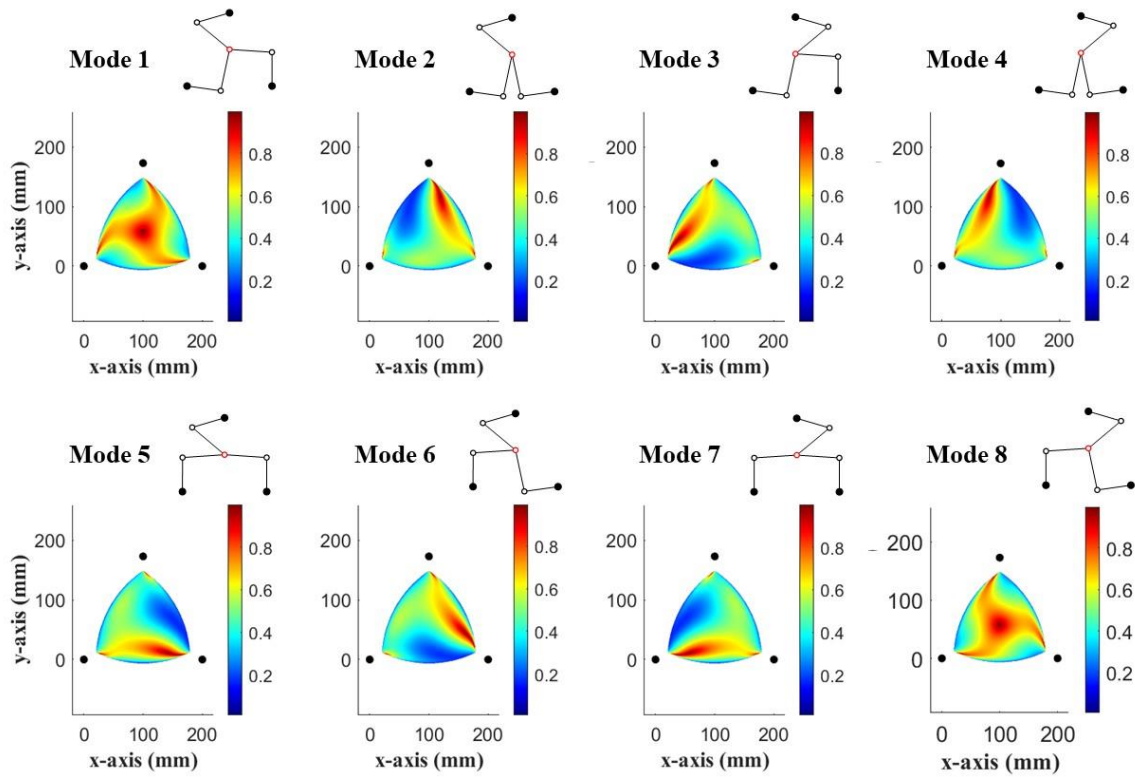

924
925

926
927
928

Figure 13: Representation of the forces exerted by the parallel and serial mechanisms of the interface

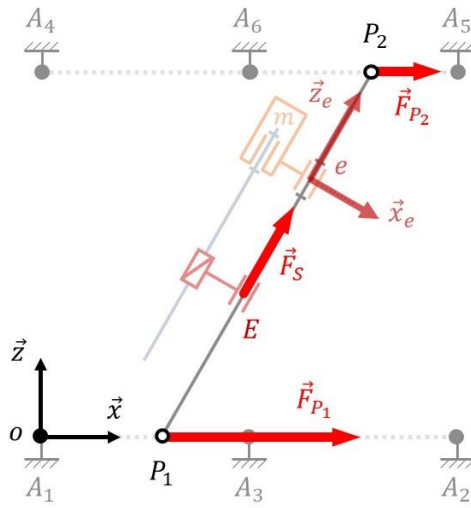

929
930

931
932

Figure 14: Representation of the geometric parameters of the interface

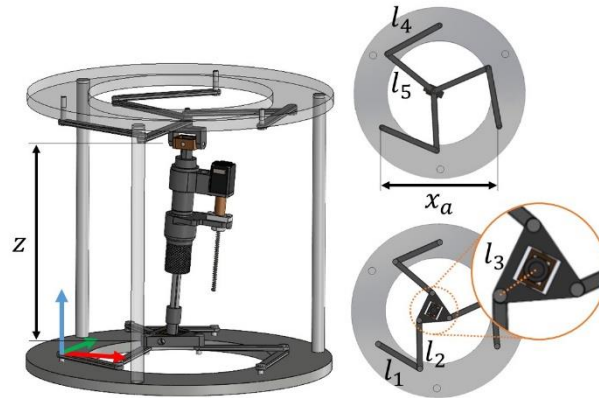

933
934

935 **Figure 15: (a) Translational workspace with fixed end-effector orientation equal to 90°**
936 **and (b) rotational workspaces of the interface around the drilling entry point with**
937 **coordinates [160.5 92.6 100] mm in blue and [125 175 90] mm in orange**
938

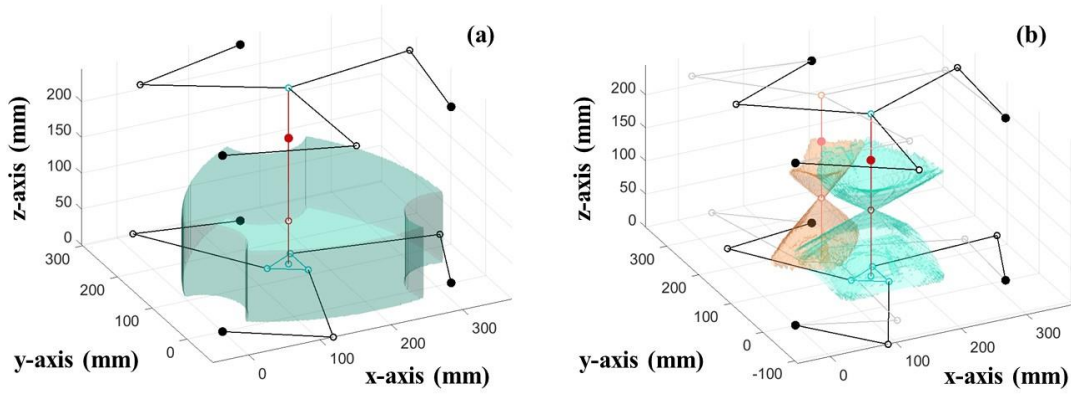

939
940

941
942
943
944

Figure 16: Distribution of motor torques generated by each actuator for the configurations where the dexterity values of the parallel mechanisms are (a) the highest and (b) the lowest

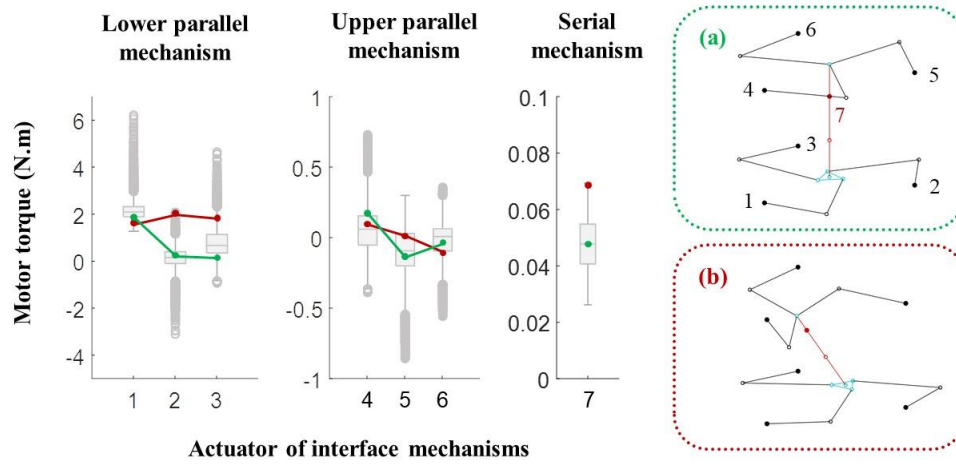

945
946

947
948

Figure 17: Design of the motorized interface prototype

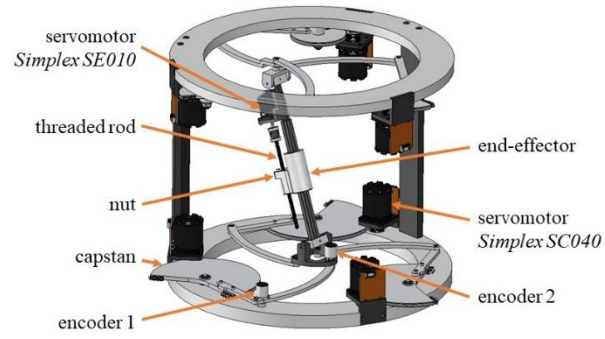

949
950

951
952**Table 1: Main advantages and disadvantages of the rigid-link interface classes**

Class	Advantages	Disadvantages
Serial	<ul style="list-style-type: none"> • Large workspace 	<ul style="list-style-type: none"> • Need for more powerful actuators • Low rigidity • Lower accuracy • Higher inertia
Parallel	<ul style="list-style-type: none"> • High rigidity • Increased accuracy 	<ul style="list-style-type: none"> • Limited workspace • Higher friction • Low compactness
Hybrid	<ul style="list-style-type: none"> • Combines the advantages of serial and parallel classes 	<ul style="list-style-type: none"> • Low compactness • Friction

953

954
955**Table 2: Possible working modes of the 3-RRR parallel mechanism**

Mode	1	2	3	4	5	6	7	8
σ_1	+	+	+	+	-	-	-	-
σ_2	+	-	+	-	+	-	+	-
σ_3	+	+	-	-	+	+	-	-

956