



**HAL**  
open science

## Vibration attenuation of dual periodic pipelines using interconnected vibration absorbers

Mohd Iqbal, Mahesh Murugan Jaya, Alireza Ture Savadkoohi, Sébastien Baguet

► **To cite this version:**

Mohd Iqbal, Mahesh Murugan Jaya, Alireza Ture Savadkoohi, Sébastien Baguet. Vibration attenuation of dual periodic pipelines using interconnected vibration absorbers. *Engineering Structures*, 2025, 322 (Part A), pp.119045. 10.1016/j.engstruct.2024.119045 . hal-04717468

**HAL Id: hal-04717468**

**<https://hal.science/hal-04717468v1>**

Submitted on 1 Oct 2024

**HAL** is a multi-disciplinary open access archive for the deposit and dissemination of scientific research documents, whether they are published or not. The documents may come from teaching and research institutions in France or abroad, or from public or private research centers.

L'archive ouverte pluridisciplinaire **HAL**, est destinée au dépôt et à la diffusion de documents scientifiques de niveau recherche, publiés ou non, émanant des établissements d'enseignement et de recherche français ou étrangers, des laboratoires publics ou privés.

1 **Vibration attenuation of dual periodic pipelines using interconnected vibration absorbers**

2 Mohd Iqbal<sup>1,2\*</sup>, Mahesh Murugan Jaya<sup>3</sup>, Alireza Ture Savadkoohi<sup>1</sup> and Sebastien Baguet<sup>2</sup>

3 <sup>1</sup>Univ Lyon, ENTPE, Ecole Centrale de Lyon, CNRS, LTDS, UMR 5513, 69518 Vaulx-en-Velin,  
4 France.

5 <sup>2</sup>Univ Lyon, INSA Lyon, LaMCoS, UMR, CNRS 5259, 69621 Villeurbanne, France.

6 <sup>3</sup>Politecnico di Torino, Torino, 10129, Italy.

7 \*mohammad.iqbal@entpe.fr

8 **Abstract**

9 Pipelines are crucial elements in various engineering applications. However, unexpected  
10 vibrations from different sources can jeopardize the operational performance and potentially  
11 damage the piping structures and other connected units. This study explores flexural wave  
12 propagation and attenuation characteristics of the pipes supported periodically on a rack. Also, a  
13 specific case of a rack with infinite stiffness (simple support) is investigated. The dispersion  
14 relations pertinent to pipe rack scenario is obtained through transfer matrix method (TMM) in  
15 conjunction with Floquet-Bloch's theorem, and the accuracy of ensuing band gaps (BGs) are  
16 confirmed through finite element (FE) models. Following this, the modal analysis is performed to  
17 ascertain the minimum number of unit-cells necessary for the FE model to accurately mimic the  
18 attenuation and propagation characteristics of the corresponding infinite structure. The findings  
19 indicate that a pipe supported on rack displays resonance and Bragg-type BGs, arising from local  
20 resonance and spatial periodicity, respectively, while the pipe on simple support exhibits only  
21 Bragg-type BGs. To control low-frequency vibrations in dual pipelines placed on the rack, a novel  
22 configuration using interconnected dynamic vibration absorbers (DVAs) is proposed. The DVA  
23 consisting of two spring-damper units along with a mass is connected across the center of each

1 span of the two pipelines. The proposed DVA is designed via genetic algorithm-based  
2 optimization. It was found that the designed DVA significantly reduces the vibration of the two  
3 pipelines. The performance of DVAs improves with an increase in the mass ratio. Additionally,  
4 the performance of pipes connected with conventional tuned mass damper (TMD) is evaluated and  
5 compared with the proposed DVA. The effectiveness of DVAs is also verified by employing a  
6 white Gaussian noise as input. The proposed DVAs are efficient in scenarios involving multiple  
7 pipes within a rack, leveraging other pipe's mass, stiffness, and damping properties to mitigate  
8 vibrations in the considered pipes.

9 **Keywords**

10 Periodic rack structure, Flexural wave, Dispersion diagram, Dynamic vibration absorbers,  
11 Vibration control

<b>Abbreviation</b>	
BG	Band gap
BS	Bragg scattering
DoF	Degree-of-freedom
DVA	Dynamic vibration absorber
FE	Finite element
FFT	Fast Fourier Transform
GA	Genetic algorithm
LR	Local resonance
LB	Lower bound
PB	Pass band
PnCs	Phononic crystals
SDoF	Single-degree-of-freedom
TMD	Tuned mass damper
TMM	Transfer matrix method
UB	Upper bound

# 1. Introduction

## 1.1. Background and motivation

Pipes are crucial components in various industries including aerospace, liquified natural gas plants, nuclear plants, chemical plants, water treatment plants, and petroleum industries. They serve as conduits for transferring fluids between processing units and storage tanks. In instances where long pipelines exist, rack structures or columns/piers are used at regular intervals to support them. Such pipelines may encounter vibrations from different factors including machinery, base excitation, explosions, wind, flow-induced turbulence, etc. Over time, these vibrations can lead to instability, fatigue failure, loosening of joints, etc. [1]. Additionally, these vibrations can generate excessive noise, impacting health of workers operating in the vicinity. Therefore, attaining higher stability and vibration control standards in pipes is essential [2].

In recent years, phononic crystals (PnCs) gained significant attention from the research community. PnCs are composite structures made up of a periodic array of scatterers embedded in a host medium. Due to impedance mismatch of scatterers, these structures can block waves within specific frequency ranges, resulting in band gaps (BGs). Waves of other frequencies can freely pass through, and are referred to as pass bands (PBs) [3]. This unique characteristic enables PnCs to work as efficient wave filters, facilitating their application in controlling sound and vibrations. BGs in periodic structures occur either from Bragg scattering (BS) [4] or local resonance (LR) [5]. In the former, BGs arise from multiple scattering of the periodic inclusions, and occur when the unit-cell length  $L$  and the wavelength  $\lambda$  are comparable in a periodic structure. The position of  $n^{\text{th}}$  order BG is determined by the Bragg condition  $L = n \left( \frac{\lambda}{2} \right)$  ( $n = 1, 2, 3, \dots$ ). Conversely, LR BGs originate from the interaction between elastic waves and localized scattering units, and they are independent of the structural periodicity. Frequency range of LR BG is approximately two orders

1 of magnitude lower than that from Bragg scattering [6]. By optimally tuning the system properties,  
2 LR BGs can be used to effectively control vibration and noise within the targeted frequency range  
3 [7–9].

4 There are several studies that discuss the BGs in structures due to BS [10–14]. Recently, Pelat et  
5 al. [15] investigated Bragg-type BG in periodically corrugated beams and concluded that their  
6 central frequency and width depend solely on the beam thickness. Ding et al. [16] used the transfer  
7 matrix method (TMM) to analyze the BGs behavior in periodic jointed tunnels under the influence  
8 of moving load. Zhao et al. [17] introduced PnC beam featuring flexural BGs to control vibrations  
9 in the low-frequency range. Sorokin et al. [18] studied BG properties in homogeneous and periodic  
10 waveguide via finite element method. Carta et al. [19] considered a bridge as an infinite periodic  
11 structure and analyzed the BG characteristics. Shen et al. [4] examined the impact of moving loads  
12 and flowing fluid on BGs in fluid-conveying shells placed on elastic foundations using TMM. Guo  
13 et al. [20] examined the flexural wave propagation characteristics in periodically orthogonal  
14 stiffened plates with holes of varying sizes.

15 Unlike Bragg BGs, LR BGs arise due to locally resonant units in the systems [21]. This concept  
16 has been used to control low-frequency vibrations in various structures like pipes [3,6,22], beams  
17 [23–25], plates [26,27], shafts [28,29], and railway tracks [30,31]. Recently, Li et.al [32] designed  
18 a system consisting of a double beam with periodically attached resonators to control flexural wave  
19 propagation in the low-frequency range. Zhao et al. [33] investigated one-dimensional wave  
20 propagation characteristics of metamaterials with double resonators. Lee et al. [34] proposed a  
21 metamaterial configuration of a periodic duct for reducing longitudinal vibrations at low  
22 frequencies. Xiao et al. [35] studied new metamaterial designs to achieve wide BGs at low  
23 frequencies. These systems encompass both monatomic and diatomic configurations using a

1 combination of negative stiffness absorbers and the rotation of flexural beams amplified by  
2 outriggers. Li and Sheng [36] conducted analytical and numerical studies on the BGs in an LR  
3 plate featuring a periodic array of single and multi degree-of-freedom (DoF) resonators.  
4 In the context of pipes, Liang et al. [37] explored the flexural-torsional vibration BG characteristics  
5 of an eccentric fluid-conveying pipe made of alternating materials along its length. Wu et al. [38]  
6 investigated the BG properties of a composite pipeline filled with liquid. The pipeline was  
7 composed of alternate materials, and the study analyzed the effects of fluid-structure interaction  
8 and material properties on the BG characteristics. Liang and Yang [39] examined the BG behavior  
9 of a fluid-conveying pipe and analyzed its dependence on the flow velocity. Yu et al. [40]  
10 investigated the attenuation properties of a periodically changing cross-section pipe using TMM.  
11 Surface wave attenuation in a shallow buried pipe was studied using both analytical and numerical  
12 approach in the frequency domain by Ni et al. [41]. Liang et al. [42] examined the flexural vibration  
13 properties of a fluid-conveying PnC pipe using TMM. The study also demonstrated the effects of  
14 spinning motion of the pipe on the BGs. Wu et al. [43] analyzed the behavior of torsional vibration  
15 in a fluid-filled pipe using the TMM and further studied the effects of pipe wall material and  
16 support parameters on BGs. Liang et al. [44] designed a laminated fiber-reinforced composite pipe  
17 with piezoelectric actuators periodically attached along its length to excite the phononic BG. A  
18 control strategy has been proposed to suppress vibrations in fluid-conveying pipes using periodic  
19 acoustic black hole wedges by Bu et al. [45]. Geng et al. [46] explored the flexural BGs in a sleeved  
20 PnC pipe in thermal environment and also showed the effects of thermal stresses on the BG  
21 properties. Plisson et al. [47] employed numerical and experimental approaches to obtain vibration  
22 BG in a bi-material pipe comprising of alternating cross sections.

1 Another common strategy to control vibration involves incorporating resonators in the host  
2 structures. For example, Fernandes et al. [48] studied the influence of resonator mass and fluid  
3 flow velocity on the bounding frequencies of BGs in a metamaterial pipe. Lei et al. [6] improved  
4 the BG properties of a meta-pipe using negative stiffness SDoF resonators. Liang et al. [49]  
5 developed a two-dimensional hybrid BS-LR metamaterial pipe, and demonstrated the influence of  
6 flow properties on the BGs. Cai et al. [22] proposed quasi-zero stiffness resonator to control low  
7 frequency vibrations in a pipe. Matos et al. [50] explored the flexural BGs in a periodic pipe  
8 conveying two-phase intermittent flow. Attenuation characteristics of a pipe attached with local  
9 resonators were examined by Borgi et al. [51]. Iqbal et al. [52] analyzed the BGs in a pipe with  
10 two DoF resonators under different boundary conditions. The vibration attenuation strength of a  
11 uniform pipe equipped with piezoelectric patches was enhanced through the synergistic effects of  
12 Bragg scattering and electro-elastic resonance by Lyu et al. [53]. Liu et al. [54] examined the  
13 attenuation properties of a metamaterial pipe and found that the effect of axial load on BGs was  
14 more significant than that of the fluid pressure. Yu et al. [55] studied the BS and LR BG properties  
15 in a periodically supported fluid-conveying pipe under external moving load using TMM. The  
16 vibration attenuation properties of a fluid-conveying pipe resting on periodic inerter-based  
17 resonant supports were investigated by Scutteri et al. [56]. Wu et al. [57] analyzed wave  
18 propagation in a composite fluid-filled pipe with periodic axial support and dynamic vibration  
19 absorbers.

20 PBs in periodic structures refer to frequency ranges where waves transport energy, leading to noise  
21 and vibration. It is essential to control vibrations when they fall in frequency of interest. To address  
22 this, various passive control techniques are available. Tuned mass damper (TMD) [58] is a  
23 commonly employed control technique in which a secondary mass characterized by a specific

1 mass ratio  $\mu$ , is connected to the primary structure via spring-damper elements. TMD absorbs  
2 energy from the primary structure, which is subsequently dissipated by its intrinsic damping  
3 properties [59]. To achieve optimal control for any specified  $\mu$ , the stiffness and damping  
4 properties of the TMD must be designed appropriately [60]. For this, a significant response of the  
5 primary system, usually acceleration or displacement is minimized. Closed-form analytical  
6 expressions are available for determining the optimal spring-damper properties of TMDs for  
7 simple structures subjected to typical standard excitations [61–63]. Many of these expressions are  
8 derived using certain assumptions, limiting their applicability to simple structures [64]. Therefore,  
9 in situations involving complex structures or unconventional loading conditions, numerical  
10 optimization schemes are employed for designing TMDs [65–67].

11 Various forms of TMDs are available for controlling vibrations in pipeline systems [65]. Each of  
12 these systems includes an external mass along with spring-damper elements with specified  
13 properties attached to the pipe for control. Stiffness in such cases is either due to shear or bending  
14 strength of the employed elastomer materials [68,69], while damping may arise from various  
15 sources such as the impact of the TMD mass against surfaces [66], material damping of elastomers  
16 [70], fluid damping of the mass [71], etc. Although conventional TMD systems are efficient, they  
17 have a drawback of employing an additional mass with the primary structure, leading to an increase  
18 in total mass of the system. It is feasible to utilize any existing mass within the system to serve as  
19 an energy dissipation and control mechanisms. Although, the performance of these systems is  
20 debatable, they offer a promising, cost-effective and simple method for controlling structure.

### 21 *1.2. Novelty and core contribution*

22 A theoretical and numerical study of propagation characteristics of flexural waves in a periodic  
23 pipe  $P_1$  placed on a rack structure is conducted. The corresponding dispersion relation is derived



1 employing the TMM in conjunction with Floquet-Bloch's theorem. The resulting BG  
2 characteristics are confirmed through a finite element (FE) model. Subsequently, a modal analysis  
3 is performed to determine the optimal number of unit-cells needed for the FE model to accurately  
4 replicate the BG and PB ranges of the corresponding infinite structure. The study presents a novel  
5 approach to control low-frequency vibrations in dual periodic pipeline systems. To control  
6 vibrations in a PB, a single-degree-of-freedom (SDoF) dynamic vibration absorber (DVA) is  
7 initially attached at the midpoint of each span of the two identical pipes  $P_1$  and  $P_2$ , as shown in  
8 Fig. 1. The equivalent model is illustrated in Fig. 2(b). Subsequently, to compare the performance  
9 of DVA with a conventional SDof TMD, the latter is installed in each span of both the pipes as  
10 shown in Fig. 2(c). Unlike conventional TMD, the proposed DVA has the advantage that only a  
11 minimal mass needs to be added to control both pipelines. Detailed optimization studies were  
12 conducted to design these systems. The efficiency of the proposed DVAs is verified under a white  
13 Gaussian noise input. The proposed concept of DVA is efficient for simultaneously controlling  
14 vibrations of multiple pipelines, and can be easily executed in power and process industries. This  
15 unique idea of DVA can also be applied in scenarios involving parallel beam type flexural systems  
16 such as periodic railway tracks, closely spaced bridges, underwater tunnels, etc.

17 This paper is organized as follows: Section 2 describes the analytical and numerical model of pipes  
18 with rack structure. The analytical dispersion relation is first derived and a FE model is built to  
19 validate the former. Subsequently, the vibration control scheme along with their optimal design is  
20 discussed. Section 3 presents the results for both uncontrolled and controlled pipe. The main  
21 findings of the work including future prospects are summarized in Section 4.

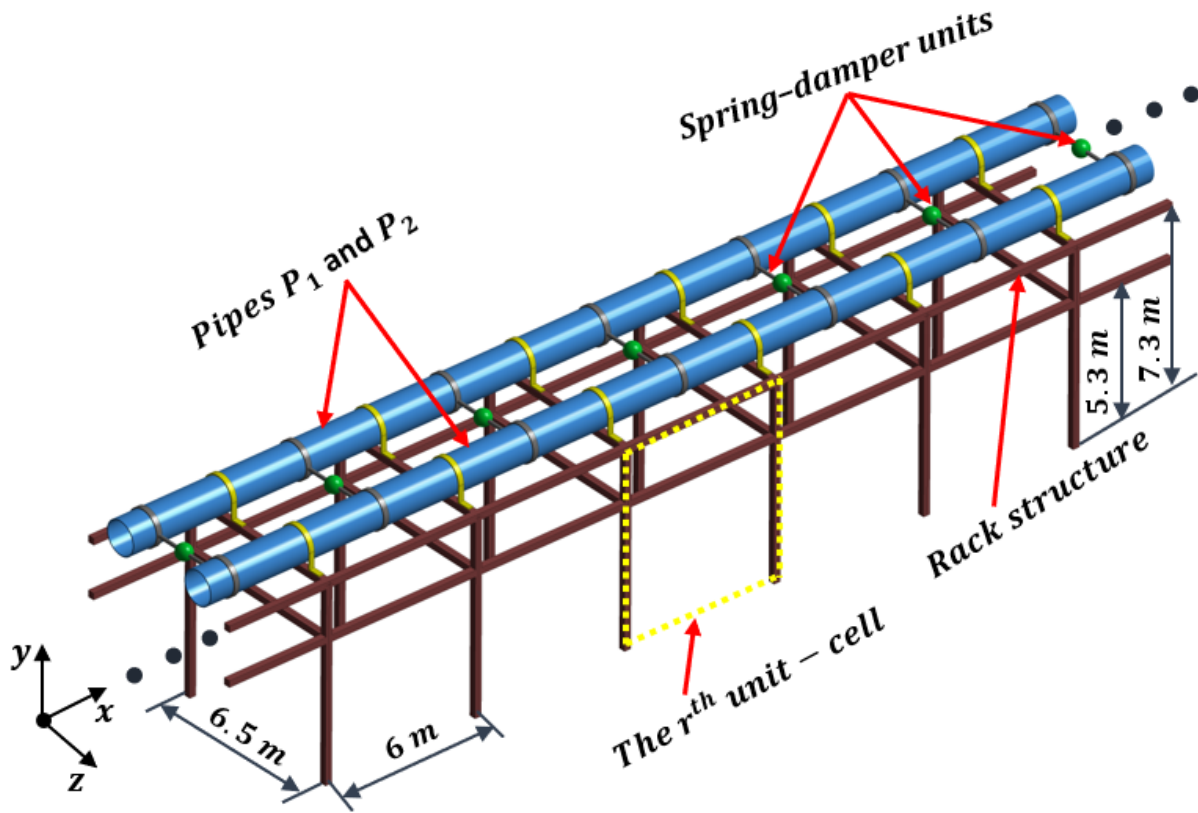

1

2 **Fig. 1.** Pipes  $P_1$  and  $P_2$  of identical properties supported on the rack structure.

3 **2. Analytical and numerical modelling**

4 This section discusses the modelling techniques used for the pipe supported periodically on a rack  
 5 structure followed by the design of DVA. For this, the pipe-rack structure illustrated in Fig. 1 is  
 6 utilized. It comprises of two levels, first situated at 5.3 m and the second at 7.3 m from the ground.

7 The distance between two successive columns along the pipe is 6 m, whereas the width of the rack  
 8 is 6.5 m. More details about this rack can be found in Bursi et al. [72]. The coordinate  $x$ ,  $y$  and  $z$   
 9 in Fig. 1 respectively represent the longitudinal (along the pipe), lateral and vertical directions.

10 A 3D FE model of the rack, comprising forty unit-cells, was initially developed. The first  
 11 predominant mode (along  $z$ -axis) was identified at a frequency of 4.5 Hz. An equivalent model of  
 12 the rack, representing its behavior in the lateral direction, was created as shown in Fig. 2(a). Here,

1 the lumped mass  $M_{pr}$  and stiffness  $K_{pr}$  were calculated to replicate the behavior of 3D model for  
2 this mode. This resulted in values of  $M_{pr} = 2.3E4$  kg and  $K_{pr} = 1.8E6$  N/m. The pipe has an  
3 inner diameter of 390.56 mm and an outer diameter of 406.40 mm, with a Young's modulus of  
4  $2E11$  N/m<sup>2</sup> and a density of 7800 kg/m<sup>3</sup>. A material damping ratio ( $\xi$ ) of 2% is taken into  
5 account for both pipe and the rack. The rack is modelled as a SDoF spring-mass system, and the  
6 pipe is modelled using Euler-Bernoulli beam theory. For simplicity, any effects of the fluid flowing  
7 through the pipes such as its mass and velocity are neglected in the analysis. The mass of the  
8 secondary pipe  $P_2$  that is already present in the rack is not considered in the formulation of  
9 dispersion relation of  $P_1$ .

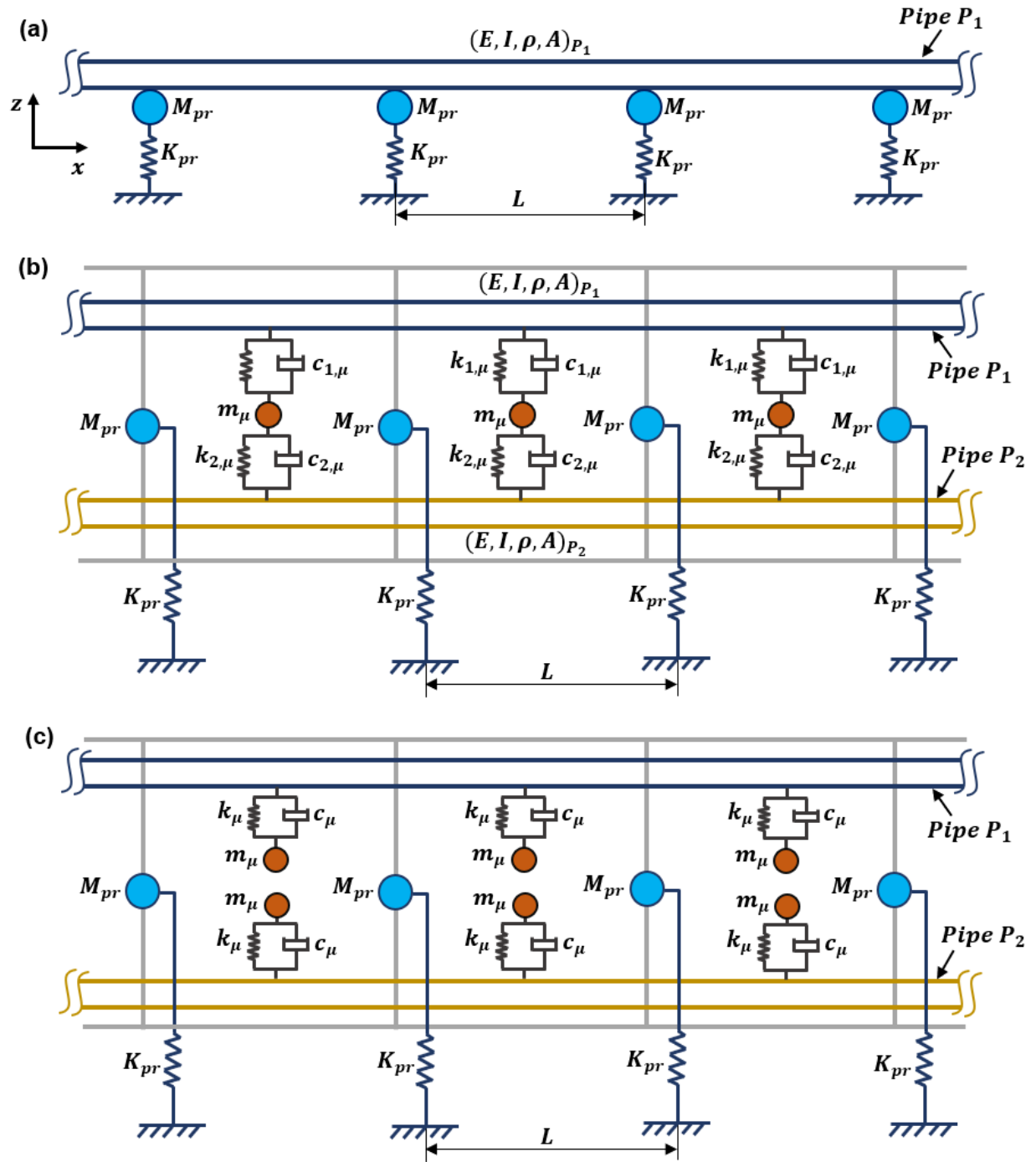

1

2 **Fig. 2.** Equivalent numerical model of Fig. 1: (a)  $P_1$  supported on rack; (b) rack containing two  
 3 pipes  $P_1$  and  $P_2$  interconnected by dynamic vibration absorbers, and (c) Conventional tuned mass  
 4 dampers connected to  $P_1$  and  $P_2$ .

1 For controlling specific PB in the pipe, DVA and TMDs are respectively employed as shown in  
 2 Figs. 2(b) and (c). The DVA consists of an external mass  $m_\mu$  of mass ratio  $\mu$  connected to pipe  $P_1$   
 3 and  $P_2$  in each span using two sets of spring-damper units ( $k_{1,\mu}$ ,  $c_{1,\mu}$  and  $k_{2,\mu}$ ,  $c_{2,\mu}$ ). Similarly,  
 4 spring-damper properties  $k_\mu$  and  $c_\mu$  and mass  $m_\mu$  is adopted for the conventional TMDs connected  
 5 to both the pipes. When a particular pipe (say  $P_1$ ) is subjected to undesirable vibration, the DVA  
 6 along with other pipe  $P_2$  gets mobilized in controlling vibrations. Since  $P_2$  is connected to  $P_1$ , it  
 7 may sometimes produce undesirable vibration in the former and it has to ensure that this is within  
 8 the permissible limits. The proposed DVA works identically for both the pipes. However, in case  
 9 of conventional TMDs, only the TMD associated with the vibrating pipe is activated.  
 10 For given pipe dimensions and mass  $m_\mu$ , optimal properties of spring-damper units of the DVA  
 11 can be determined. In practice, the DVA can be realized by connecting the pipes to a mass  $m_\mu$   
 12 using spring-damper elements (e.g., steel springs, hydraulic dampers, etc.) with required stiffness  
 13 and damping properties. The derivation of dispersion relation for the pipes coupled with DVA is  
 14 not straightforward, therefore numerical model is used in these situations. The optimal stiffness-  
 15 damping values of DVA are calculated by genetic algorithm (GA) optimization given in Section  
 16 2.3.

### 17 *2.1. Dispersion equation*

18 For the analysis of flexural wave propagation in the pipe system shown in Fig. 1, a typical unit-  
 19 cell of pipe with span  $L$  shown in Fig. 3 is used. The transfer matrix method (TMM) and Floquet-  
 20 Bloch periodic condition is employed to formulate the dispersion equation. The Floquet-Bloch  
 21 theorem relates the displacements at the boundary DoFs of adjacent unit-cells. The left and right  
 22 ends of the pipe are represented by  $x_r$  and  $x_{r+1}$ , respectively.

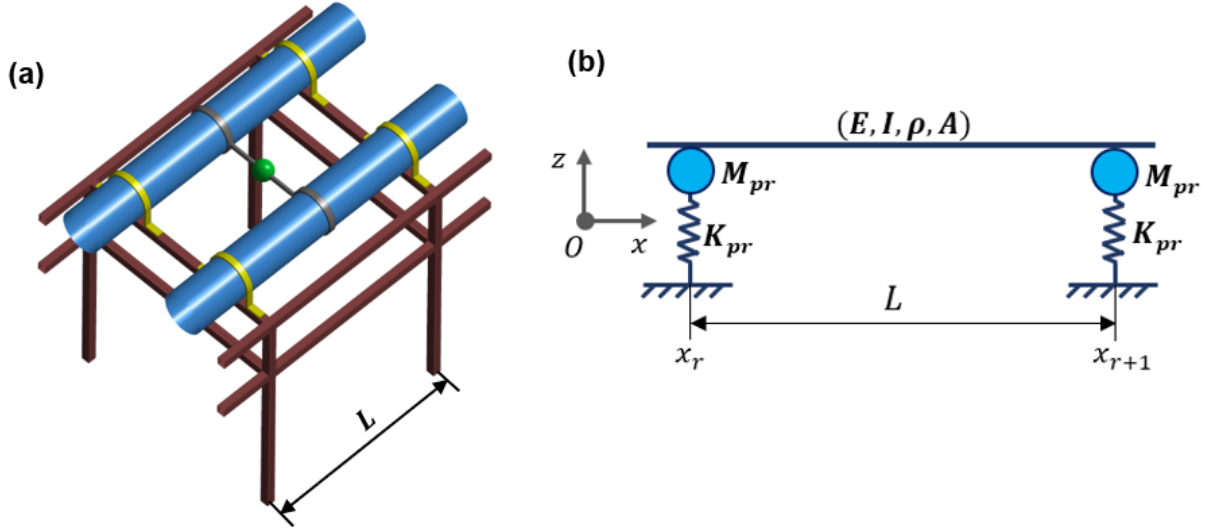

1

2 **Fig. 3.** Schematics of a unit-cell shown in Fig. 1: (a) Representation of  $r^{th}$  span; and (b) Simplified  
 3 model showing a single span of pipe  $P_1$ .

4 The pipe is assumed to be undamped and modelled as a Euler-Bernoulli beam. The transverse  
 5 displacement  $z(x, t)$  of the pipe at position  $x$  and time  $t$  is given by the following differential  
 6 equation:

$$\frac{\partial^2}{\partial x^2} \left[ EI \frac{\partial^2 z(x, t)}{\partial x^2} \right] + \rho A \frac{\partial^2 z(x, t)}{\partial t^2} = 0 \quad (1)$$

7 where  $E$ ,  $I$ ,  $\rho$ , and  $A$  denote the Young's modulus, moment of inertia, density and cross-sectional  
 8 area, respectively. A harmonic solution of Eq. (1) can be assumed as,

$$z(x, t) = Z(x, \omega) e^{i\omega t} \quad (2)$$

9 where  $Z(x, \omega)$  and  $\omega = 2\pi f$  represent the frequency dependent amplitude, and frequency of the  
 10 wave, respectively, and  $i = \sqrt{-1}$ . Substitution of Eq. (2) in Eq. (1) gives,

$$EI \frac{\partial^4 Z(x, \omega)}{\partial x^4} - \rho A \omega^2 Z(x, \omega) = 0 \quad (3)$$

1 The solution of (3) in frequency domain is expressed as,

$$Z(x, \omega) = A_1 e^{\beta x} + A_2 e^{-\beta x} + A_3 e^{i\beta x} + A_4 e^{-i\beta x} \quad (4)$$

2 where  $A_1, A_2, A_3$  and  $A_4$  are the wave mode coefficients that depend on  $\omega$ , and  $\beta = \left(\frac{\rho A \omega^2}{EI}\right)^{\frac{1}{4}}$  is  
 3 the wavenumber.

4 Rotational angle ( $\theta$ ) is obtained by differentiating  $Z(x, \omega)$  with respect to the spatial coordinate  $x$   
 5 as,

$$\theta(x, \omega) = \frac{\partial Z}{\partial x} = \beta (A_1 e^{\beta x} - A_2 e^{-\beta x} + iA_3 e^{i\beta x} - iA_4 e^{-i\beta x}) \quad (5)$$

6 Bending moment ( $M$ ) and shear force ( $V$ ) can be obtained by,

$$M(x, \omega) = -EI \frac{\partial^2 Z}{\partial x^2} \quad (6)$$

$$V(x, \omega) = -EI \frac{\partial^3 Z}{\partial x^3} \quad (7)$$

7 State vector  $\Psi(\mathbf{x}, \omega)$  of the beam consisting of displacement states (transverse displacement  
 8  $Z(x, \omega)$  and rotation  $\theta(x, \omega)$ ) and force states (bending moment  $M(x, \omega)$  and shear force  $V(x, \omega)$ )  
 9 is defined as,

$$10 \quad \Psi(\mathbf{x}, \omega) = \{Z(x, \omega), \theta(x, \omega), M(x, \omega), V(x, \omega)\}^T$$

1 The state vector at the left support  $x_r$  is,

$$\Psi(\mathbf{x}_r) = \begin{Bmatrix} Z(x_r) \\ \theta(x_r) \\ M(x_r) \\ V(x_r) \end{Bmatrix} = \mathbf{T}_b(\mathbf{x}_r)\mathbf{A} \quad (8)$$

2 where  $\mathbf{T}_b(\mathbf{x}_r) = \begin{bmatrix} e^{\beta x_r} & e^{-\beta x_r} & e^{i\beta x_r} & e^{-i\beta x_r} \\ \beta e^{\beta x_r} & -\beta e^{-\beta x_r} & i\beta e^{i\beta x_r} & -i\beta e^{-i\beta x_r} \\ -EI\beta^2 e^{\beta x_r} & -EI\beta^2 e^{-\beta x_r} & EI\beta^2 e^{i\beta x_r} & EI\beta^2 e^{-i\beta x_r} \\ -EI\beta^3 e^{\beta x_r} & EI\beta^3 e^{-\beta x_r} & iEI\beta^3 e^{i\beta x_r} & -iEI\beta^3 e^{-i\beta x_r} \end{bmatrix}$ , and  $\mathbf{A} =$

3  $\{\mathbf{A}_1, \mathbf{A}_2, \mathbf{A}_3, \mathbf{A}_4\}^T$ .

4 The state vector at the right support is obtained by replacing  $x_r$  with  $x_{r+1}$  in Eq. (8), resulting in,

$$\Psi(\mathbf{x}_{r+1}) = \mathbf{T}_b(\mathbf{x}_{r+1})\mathbf{A} \quad (9)$$

5 Eq. (9) can be rewritten as,

$$\Psi(\mathbf{x}_{r+1}) = \mathbf{T}_{tb}\Psi(\mathbf{x}_r) \quad (10)$$

6 where  $\mathbf{T}_{tb} = \mathbf{T}_b(\mathbf{x}_{r+1}) \mathbf{T}_b^{-1}(\mathbf{x}_r)$  represents transfer matrix of beam, and can be expressed as,

$$\mathbf{T}_{tb} = \begin{bmatrix} (\Phi_1 + \Phi_2) & \frac{(\Phi_3 + \Phi_4)}{\beta} & \frac{(\Phi_1 - \Phi_2)}{\beta^2 EI} & \frac{(\Phi_3 - \Phi_4)}{\beta^3 EI} \\ -\beta(\Phi_3 - \Phi_4) & (\Phi_1 + \Phi_2) & -\frac{(\Phi_3 + \Phi_4)}{\beta EI} & \frac{(\Phi_1 - \Phi_2)}{\beta^2 EI} \\ \beta^2 EI(\Phi_1 - \Phi_2) & \beta EI(\Phi_3 - \Phi_4) & (\Phi_1 + \Phi_2) & \frac{(\Phi_3 + \Phi_4)}{\beta} \\ -\beta^3 EI(\Phi_3 + \Phi_4) & \beta^2 EI(\Phi_1 - \Phi_2) & -\beta(\Phi_3 - \Phi_4) & (\Phi_1 + \Phi_2) \end{bmatrix} \quad (11)$$

7 where  $\Phi_1 = \cos(\beta L)/2$ ,  $\Phi_2 = \cosh(\beta L)/2$ ,  $\Phi_3 = \sin(\beta L)/2$  and  $\Phi_4 = \sinh(\beta L)/2$ .



- 1 Similarly, transfer matrix characterizing wave propagation through the rack which is idealized as  
 2 a SDoF system with a lumped mass  $M_{pr}$  and stiffness  $K_{pr}$  is denoted as  $\mathbf{T}_{pr}$ , and is given by,

$$\mathbf{T}_{pr} = \begin{bmatrix} 1 & 0 & 0 & 0 \\ 0 & 1 & 0 & 0 \\ 0 & 0 & 1 & 0 \\ K_{pr} - M_{pr}\omega^2 & 0 & 0 & 1 \end{bmatrix} \quad (12)$$

- 3 Incorporating  $\mathbf{T}_{pr}$  in Eq. (10), cumulative transfer matrix  $\mathbf{T}$  of coupled pipe-rack structure will be,

$$\Psi(\mathbf{x}_{r+1}) = \mathbf{T}_{pr}\mathbf{T}_{tb}\Psi(\mathbf{x}_r) = \mathbf{T}\Psi(\mathbf{x}_r) \quad (13)$$

- 4 Owing to the periodicity in  $x$  direction, the state vectors at the ends  $r$  and  $r + 1$  are related using  
 5 the Floquet-Bloch's theorem [73,74] as,

$$\Psi(\mathbf{x}_{r+1}) = e^{-i\kappa L}\Psi(\mathbf{x}_r) \quad (14)$$

- 6 Here,  $\kappa$  is wavenumber of the flexural wave propagating in the coupled pipe-rack structure.  
 7 Substituting Eq. (14) in (13) yields a standard eigenvalue problem as,

$$[\mathbf{T} - e^{-i\kappa L}\mathbf{I}_4]\Psi(\mathbf{x}_r) = \mathbf{0} \quad (15)$$

- 8 where  $\mathbf{I}_4$  is  $4 \times 4$  identity matrix. For existence of a non-trivial solution for (15), the determinant  
 9 of  $[\mathbf{T} - e^{-i\kappa L}\mathbf{I}_4]$  should be zero. Thus,

$$|\mathbf{T} - e^{-i\kappa L}\mathbf{I}_4| = 0 \quad (16)$$

- 1 The solution of (16) represents the relation between  $\kappa$  and  $\omega$ , and indicates the dispersion equation  
 2 for the coupled pipe-rack system shown in Fig. 2 (a). It is given as,

$$\begin{aligned}
 & [ \{ \Phi_2 - \Phi_1 \}^2 - \{ \Phi_4^2 - \Phi_3^2 \} ] \cos^2(\kappa L) \\
 & + 2 \left[ \{ \Phi_4 - \Phi_3 \} \{ \Phi_2 \Phi_3 + \Phi_1 \Phi_4 \} - \{ \Phi_2 \Phi_3 - \Phi_1 \Phi_4 \} \{ \Phi_3 + \Phi_4 \} \right. \\
 & \left. + \frac{ \{ \Phi_4 - \Phi_3 \} \{ 1 - \Phi_1 \Phi_2 \} \{ K_{pr} - M_{pr} \omega^2 \} }{ 8EI\beta^3 } \right] \cos(\kappa L) \\
 & + \left[ 4 \{ \Phi_3^2 \Phi_2^2 - \Phi_1^2 \Phi_4^2 \} - \{ \Phi_2 - \Phi_1 \}^2 \right. \\
 & \left. + \frac{ \{ \Phi_2 \Phi_3 - \Phi_1 \Phi_4 \} \{ 1 - \Phi_1 \Phi_2 \} \{ K_{pr} - M_{pr} \omega^2 \} }{ 2EI\beta^3 } \right] = 0
 \end{aligned} \tag{17}$$

- 3 Coefficients  $\Phi_1$ ,  $\Phi_2$ ,  $\Phi_3$  and  $\Phi_4$  in Eq. (17) are function of  $\beta$ , the solution of which yields two  
 4 pairs of wave number  $\pm\kappa_1$  and  $\pm\kappa_2$  for each  $\omega$ . Here, each pair represents identical waves traveling  
 5 in opposite direction. In general,  $\kappa$  may be real, purely imaginary, or complex. If  $\kappa$  is real, the wave  
 6 passes through each unit-cell without any attenuation, but with a phase change at each unit-cell.  
 7 Conversely, if  $\kappa$  is purely imaginary, the wave attenuates across each unit-cell vibrating in phase  
 8 or out of phase, and is referred to as attenuating or evanescent wave. For a complex  $\kappa$ , waves of  
 9 certain frequency propagate while others get attenuated, resulting in the presence of both PBs and  
 10 BGs in the dispersion diagram [75].

## 11 2.2. Numerical Modelling

- 12 To validate the analytical dispersion relations calculated using Eq. (17), a FE model of  $P_1$  coupled  
 13 to rack as shown in Fig. 2(a) is built for forty spans using ANSYS APDL [76]. The pipe is modelled  
 14 using BEAM4 element which is a 2-node Euler-Bernoulli beam, while for the spring and lumped  
 15 mass, COMBIN14 and MASS21 elements are respectively used.

1 Let  $\mathbf{M} \in \mathbb{R}^{n \times n}$ ,  $\mathbf{K} \in \mathbb{R}^{n \times n}$  and  $\mathbf{C} \in \mathbb{R}^{n \times n}$  respectively be the mass, stiffness and damping  
2 matrices of the coupled pipe-rack system which has  $n$  DoFs. If  $\{\ddot{\mathbf{q}}\} \in \mathbb{R}^{n \times 1}$ ,  $\{\dot{\mathbf{q}}\} \in \mathbb{R}^{n \times 1}$  and  
3  $\{\mathbf{q}\} \in \mathbb{R}^{n \times 1}$  respectively denote the acceleration, velocity, and displacement at time  $t$ , the system's  
4 equation of motion without any external excitation is given by,

$$\mathbf{M}\{\ddot{\mathbf{q}}\} + \mathbf{C}\{\dot{\mathbf{q}}\} + \mathbf{K}\{\mathbf{q}\} = \{\mathbf{0}\} \quad (18)$$

5 If the displacement is given at  $g$  DoFs, Eq. (18) can be rewritten as,

$$\begin{bmatrix} \mathbf{M}_{hh} & \mathbf{M}_{hg} \\ \mathbf{M}_{gh} & \mathbf{M}_{gg} \end{bmatrix} \begin{Bmatrix} \ddot{\mathbf{q}}_h \\ \ddot{\mathbf{q}}_g \end{Bmatrix} + \begin{bmatrix} \mathbf{C}_{hh} & \mathbf{C}_{hg} \\ \mathbf{C}_{gh} & \mathbf{C}_{gg} \end{bmatrix} \begin{Bmatrix} \dot{\mathbf{q}}_h \\ \dot{\mathbf{q}}_g \end{Bmatrix} + \begin{bmatrix} \mathbf{K}_{hh} & \mathbf{K}_{hg} \\ \mathbf{K}_{gh} & \mathbf{K}_{gg} \end{bmatrix} \begin{Bmatrix} \mathbf{q}_h \\ \mathbf{q}_g \end{Bmatrix} = \begin{Bmatrix} \mathbf{0}_h \\ \mathbf{0}_g \end{Bmatrix} \quad (19)$$

6 where,  $h$  refers the DoFs other than the  $g$  DoFs ( $g + h = n$ ). First row in (19) gives,

$$\mathbf{M}_{hh}\{\ddot{\mathbf{q}}_h\} + \mathbf{C}_{hh}\{\dot{\mathbf{q}}_h\} + \mathbf{K}_{hh}\{\mathbf{q}_h\} = -(\mathbf{M}_{hg}\{\ddot{\mathbf{q}}_g\} + \mathbf{C}_{hg}\{\dot{\mathbf{q}}_g\} + \mathbf{K}_{hg}\{\mathbf{q}_g\}) \quad (20)$$

7 To determine the steady state response at  $h$  DoFs under a given displacement  $\{\mathbf{q}_g\} = \{\mathbf{\Omega}_g\}e^{i\omega t}$ , a  
8 solution to  $\{\mathbf{q}_h\}$  of the form  $\{\mathbf{q}_h\} = \{\mathbf{\Omega}_h\}e^{i\omega t}$  is assumed, substitution of which in (20) leads to,

$$\{\mathbf{\Omega}_h\} = -[-\omega^2\mathbf{M}_{hh} + i\omega\mathbf{C}_{hh} + \mathbf{K}_{hh}]^{-1}[-\omega^2\mathbf{M}_{hg} + i\omega\mathbf{C}_{hg} + \mathbf{K}_{hg}]\{\mathbf{\Omega}_g\} \quad (21)$$

9 The pipe-rack system considered in this study is periodic along the length of pipe. Various  
10 techniques can be employed to induce flexural vibration in the piping system. Here, to mobilize  
11 the periodicity and replicate the flexural vibration in  $P_1$ , a harmonic rotation  $\Omega_g e^{i2\pi f t}$  with unit  
12 amplitude is imposed at the left end of the pipe. The resulting steady-state output rotation  $\Omega_h(f)$   
13 is then computed at the right end. The vibration transmission  $T_r$  (dB) behavior in the piping system  
14 can be described by,

$$T_r(f) = 20 \log_{10} \left| \frac{\Omega_h(f)}{\Omega_g(f)} \right| \quad (22)$$

1 The frequency ranges where  $T_r$  falls below zero denote BGs. To ensure their accuracy, the  
 2 variation of  $T_r$  is compared with the dispersion relations obtained from Eq. (17).

### 3 *2.3. Vibration control method*

4 DVA is employed for controlling vibrations in a particular PB in the pipelines. For an efficient  
 5 control with a given mass ratio  $\mu$  ( $\mu = m_\mu / (\rho Al)_{P_1}$ , where  $m_\mu$  is mass of the DVA), optimal  
 6 values of springs ( $k_{1,\mu}$  and  $k_{2,\mu}$ ) and dampers ( $c_{1,\mu}$  and  $c_{2,\mu}$ ) have to be employed. Let  
 7  $\|H_{Uncontrol}\|_\infty$  and  $\|H_{Control}\|_\infty$  represent the peak value of  $T_r$  calculated over the frequencies of  
 8 interest without and with DVAs, respectively. The efficiency of DVA is quantified using a  
 9 performance metric  $\Pi$  as,

$$\Pi = \|H_{Control}\|_\infty / \|H_{Uncontrol}\|_\infty \quad (23)$$

10 A lower value of  $\Pi$  indicates better performance of DVA and vice-versa. Thus, for a specified  $\mu$ ,  
 11 optimal properties of DVA are those that minimize the metric  $\Pi$ . Although multiple techniques  
 12 are available for numerically evaluating these optimal properties [77], the widely used GA  
 13 technique [66,67] is adopted here, and is explained in the following section.

#### 14 *2.3.1. GA optimization scheme*

15 Optimization for the design of DVA shown in Fig. 2(b) is formulated as,

$$\begin{Bmatrix} k_{1,\mu} \\ k_{2,\mu} \\ c_{1,\mu} \\ c_{2,\mu} \end{Bmatrix} = \arg \min(\Pi) \quad (24)$$

16 subjected to,

$$\{\mathbf{LB}\} \leq \begin{Bmatrix} k_{1,\mu} \\ k_{2,\mu} \\ c_{1,\mu} \\ c_{2,\mu} \end{Bmatrix} \leq \{\mathbf{UB}\} \quad (25)$$

1 where  $\{\mathbf{LB}\} \in \mathbb{R}^{4 \times 1}$  and  $\{\mathbf{UB}\} \in \mathbb{R}^{4 \times 1}$  denote the lower and upper bound for the design variables,  
2 respectively. These bounds are set to ensure that the design variables remain in realistic range,  
3 facilitating faster optimization. Similarly, the optimal parameters ( $k_\mu$  and  $c_\mu$ ) for the conventional  
4 TMD are determined. The value of  $\Pi$  is computed over a frequency range within the passband to  
5 be controlled.

6 GA is a stochastic search method based on the principles of natural selection and genetics [78].  
7 Within the prescribed upper and lower bounds ( $UB$  and  $LB$ ), a random initial generation  $\mathbf{X}_0 \in$   
8  $\mathbb{R}^{p \times 4}$  is created where  $p$  is the number of children. The fitness function  $\Pi$  is determined for the  
9 current generation by employing the corresponding FE models. New generations are generated  
10 according to the values of the current fitness function, progressively evolving towards the optimal  
11 solution. From generation  $j$ ,  $j + 1$  is obtained through a combination of three methods; selection,  
12 crossover and mutation. In selection,  $s$  set of solutions in  $\mathbf{X}_j$  possessing the best  $\Pi$  values are  
13 chosen and included in the  $j + 1^{th}$  generation as  $\mathbf{X}_{j,s} \in \mathbb{R}^{s \times 4}$ . Crossover produces  $c$  new solutions  
14  $\mathbf{X}_{j,c} \in \mathbb{R}^{c \times 4}$  by merging two best solutions from  $\mathbf{X}_j$ , while mutation applies random changes to  
15 solution in  $\mathbf{X}_j$  to generate  $m$  children  $\mathbf{X}_{j,m} \in \mathbb{R}^{m \times 4}$ . Selection was performed using tournament  
16 technique, while for mutation and crossover a random Gaussian distribution was employed [79].  
17 The diversity of the subsequent generation  $j + 1$  depends on the proportion of children from  
18 selection, crossover, and mutation ( $s:c:m$ ). The new generation  $\mathbf{X}_{j+1} \in \mathbb{R}^{p \times 4}$  comprising  
19 children from selection, crossover and mutation ( $\mathbf{X}_{j+1} = \mathbf{X}_{j,s} \cup \mathbf{X}_{j,c} \cup \mathbf{X}_{j,m}$  and  $p = s + c + m$ ), is  
20 now employed to determine  $\Pi$  as before. This iterative process is continued till the required  
21 convergence criterion is achieved. Fig. 4 demonstrates this algorithm.

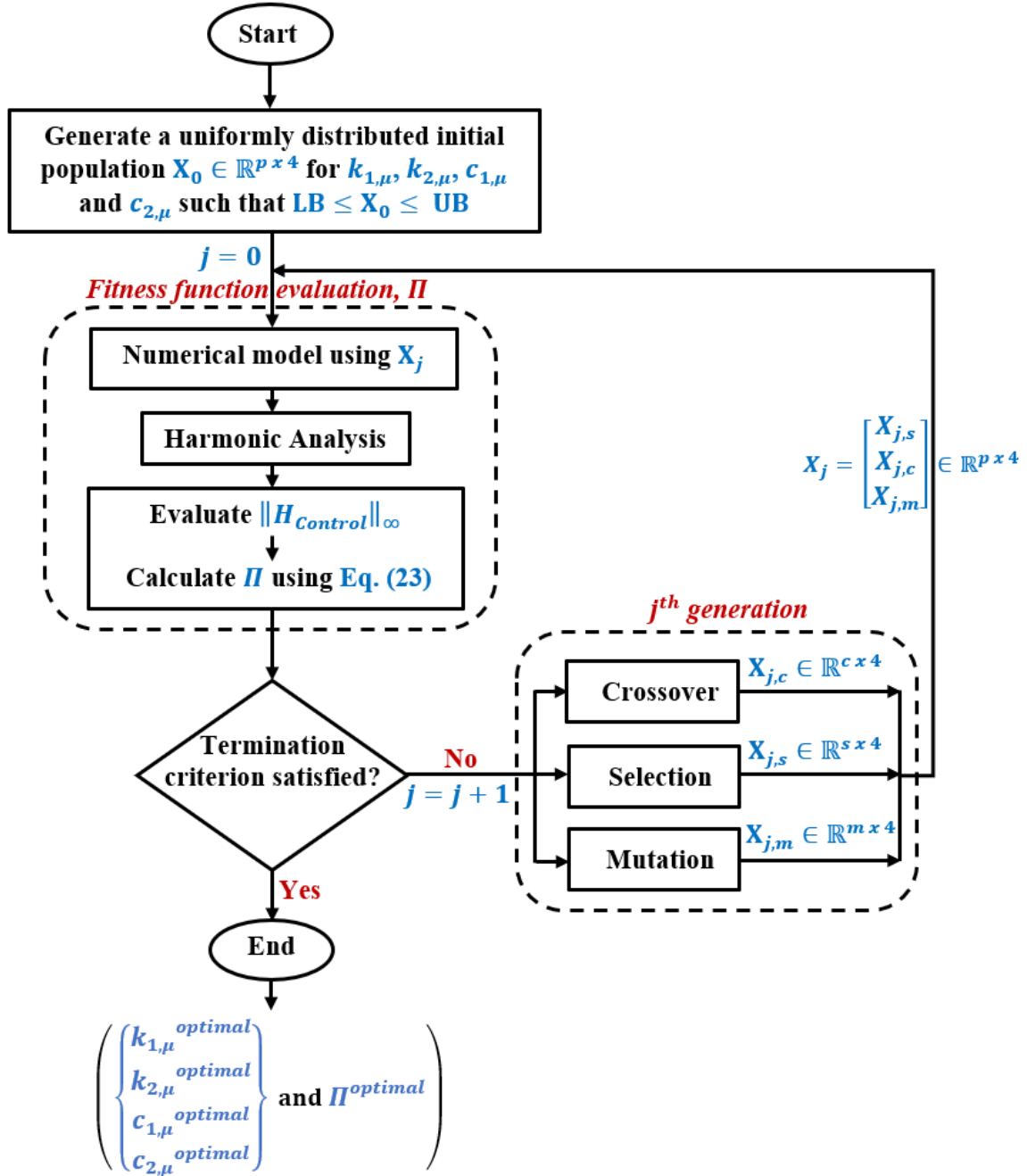

1

2 **Fig. 4.** Flow-chart for GA optimization process for the design of DVA with mass ratio  $\mu$ .

3 **3. Results and discussions**

4 The dispersion characteristics of flexural wave are initially explored in the coupled pipe-rack

5 system, along with an extreme scenario of pipe with simple supports (where the rack stiffness  $K_{pr}$

1 tends to infinity and the lumped mass  $M_{pr}$  approaches zero). FE models are employed to verify  
2 the resulting BG properties obtained from analytical models. Subsequently, DVA with different  
3 mass ratio ( $\mu$ ) is designed to control vibrations in a specific PB. Finally, the efficacy of the  
4 designed DVA is estimated by employing a white Gaussian noise as input excitation.

### 5 *3.1. Dispersion diagram*

6 The dispersion relationship in Eq. (17) is used to obtain the flexural BG properties. Figures 5(a)  
7 and (b) respectively show the frequency-dependent variations of the real and imaginary parts of  
8 both positive and negative wavenumbers ( $\pm\kappa_1L$ ). It can be noticed that both the waves exhibit  
9 identical attenuation and propagation behaviors, but of opposite nature. The BGs are observed at  
10 0 – 4.50 Hz, 5.50 – 31.10 Hz and 71.10 – 124.40 Hz, and are depicted by shaded areas. Figure  
11 5(c) shows  $T_r$  from FE model calculated based on Eq. (22). The similarity in terms of position and  
12 width of BG between analytical and FE results confirms the reliability of the developed models.  
13 A non-zero value of  $\text{Im}(\pm\kappa_1L)$  indicates the BG regions, where no waves propagate in the piping  
14 system. In contrast, PBs are the frequency ranges where  $\text{Im}(\pm\kappa_1L)$  is zero, allowing waves to  
15 propagate freely through the system. The first BG in this system stems from the LR of the rack  
16 structure, and its position is governed by the stiffness and mass properties associated with the rack's  
17 geometry. However, the other BGs arise from the BS phenomenon associated with spatial  
18 periodicity, which in this case depends on the distance between two successive columns of the  
19 rack.

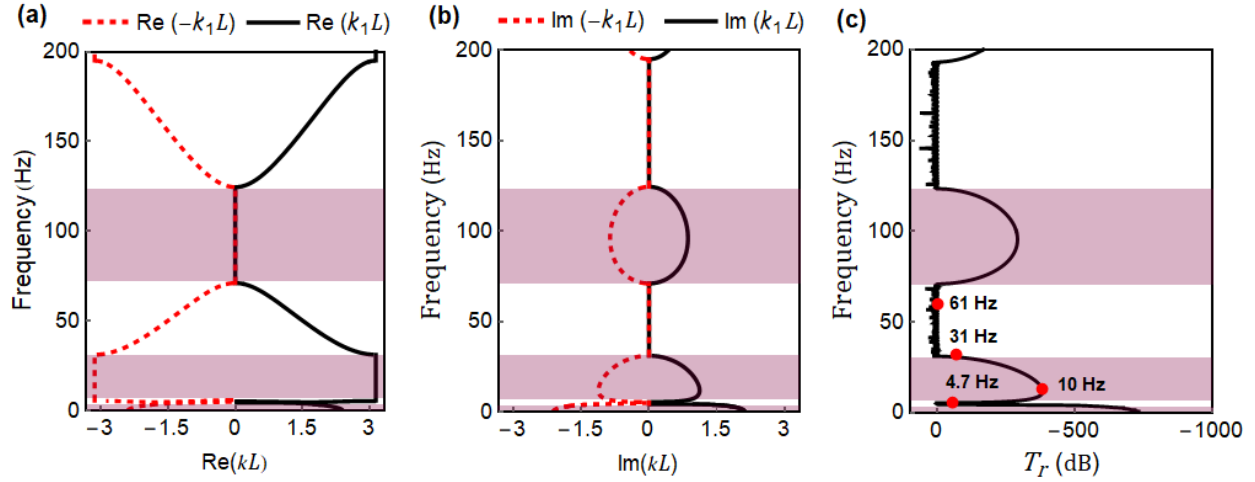

1  
2 **Fig. 5.** Dispersion diagram and vibration transmission in  $P_1$  with rack: (a)  $\text{Re}(\pm\kappa_1L)$ ; (b)  
3  $\text{Im}(\pm\kappa_1L)$ ; and (c)  $T_r$  (dB).

4 To better understand the propagation behavior of waves in the coupled pipe-rack system, four  
5 typical frequencies (4.7 Hz, 10 Hz, 31 Hz, and 61 Hz) as indicated in Fig. 5 (c) are selected. The  
6 first and last frequencies fall within the PBs caused by rack and pipe, respectively, while the  
7 remaining two lie in BGs. The resulting steady state displacement profiles in  $z$  direction (from  
8  $\{\Omega_h\}$   
 $\{\Omega_g\}$ ) at these frequencies are depicted in Fig. 6. The frequency of 4.7 Hz fall in PB, this wave  
9 passes through the structure with considerable amplitude, which can be seen in Fig. 6(a).  
10 Conversely, the attenuation at 10 Hz is remarkably high, as evidenced by the rapidly diminishing  
11 displacement along the pipe depicted in Fig. 6(b). Similarly, the displacement plot at 31 Hz shown  
12 in Fig. 6(c) indicates the attenuation in the BG. However, its amplitude does not decay as rapidly  
13 as compared to that at 10 Hz. Unlike the displacement profiles at BGs, no attenuation is observed  
14 at 61 Hz. Figure 6(d) confirms this. A comparison of the displacement profile at 4.7 Hz and 61 Hz  
15 shows the difference in the type of PB. The one at 4.7 Hz is from LR of the rack, while first bending  
16 mode of the pipe resulted in the PB around 61 Hz.



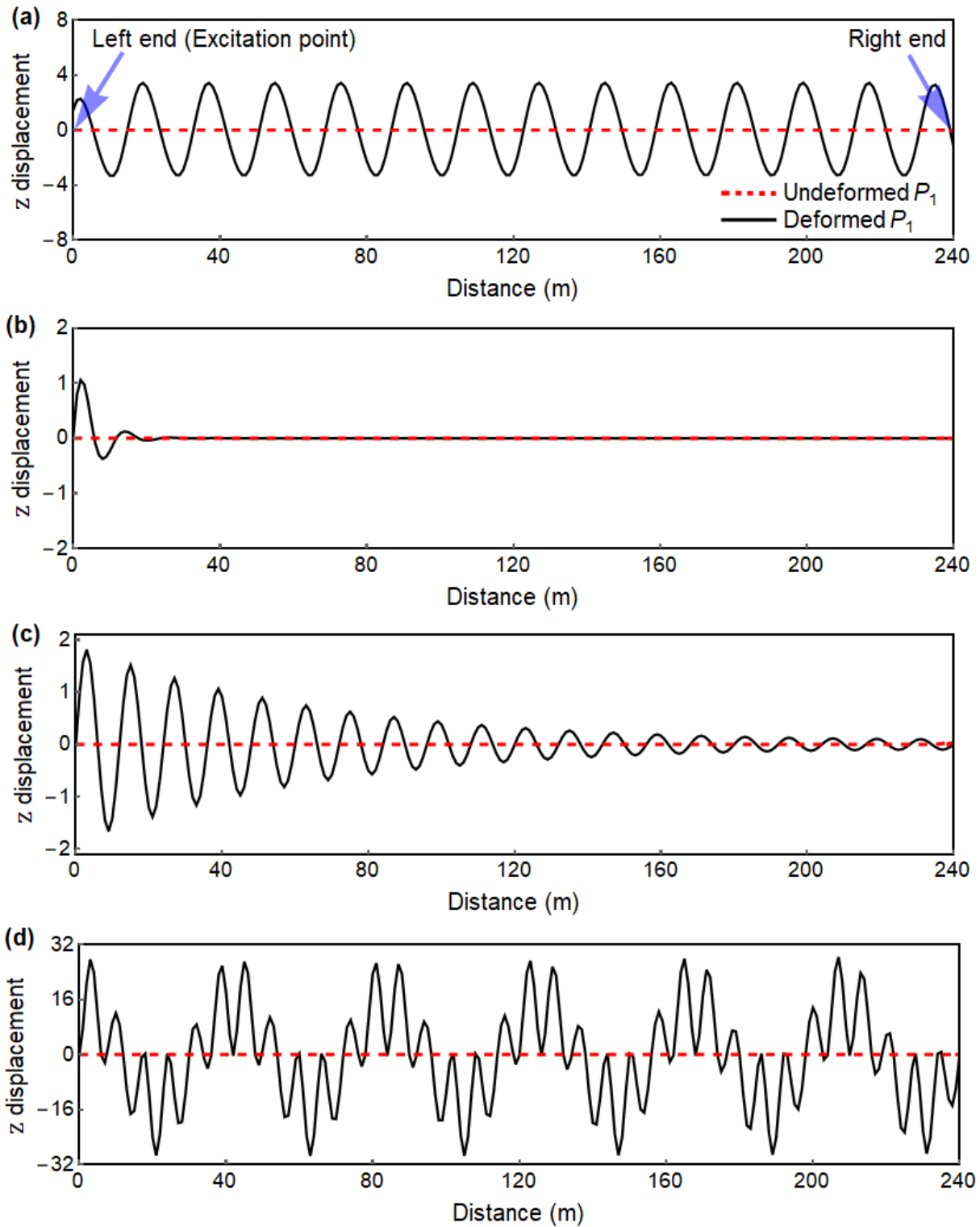

1

2 **Fig. 6.** Steady-state displacement profiles of  $P_1$  at different excitation frequencies indicated in Fig.

3 5(c): (a) 4.7 Hz; (b) 10 Hz; (c) 31 Hz; and (d) 61 Hz.

1 PBs in a periodic structure align with the cluster of corresponding natural frequencies [80]. The  
 2 clustering of natural frequencies in PBs and the attenuation strength within BGs depend on the  
 3 number of unit-cells  $N_u$ . To illustrate this, the variation of natural frequencies corresponding to  
 4  $N_u = 5, 10, 20, 30$  and  $40$  is shown in Fig. 7. The BGs are depicted by shaded regions. As can be  
 5 seen, bounding frequencies of PBs are not same for different values of  $N_u$ . As  $N_u$  increases, the  
 6 bounding frequencies become closer to the analytically predicted PB frequencies. It is noted that  
 7 the number of eigenfrequencies within each PB increases with increase in  $N_u$ . Let  $f_s^{FE}$  and  $f_t^{FE}$   
 8 respectively represent the starting and terminal frequencies of PBs calculated from FE model, and  
 9  $f_s^{AN}$  and  $f_t^{AN}$  represent the corresponding values from analytical dispersion relation which is  
 10 independent of  $N_u$ . The percentage difference in the starting frequencies of PBs from analytical  
 11 and FE model for a given  $N_u$  is calculated as [19],

$$\Delta_s = \frac{f_s^{AN} - f_s^{FE}}{f_s^{FE}} * 100 \quad (26)$$

12 Identical relations can be used to obtain the percentage difference  $\Delta_t$  in terminal frequencies. The  
 13 values of  $\Delta_s$  and  $\Delta_t$  corresponding to various PBs for different values of  $N_u$  are reported in Table  
 14 1. A small reduction is found in  $\Delta_s$  for first PB as  $N_u$  increases from 5 to 10, and become constant  
 15 with further increase in  $N_u$ . On the other hand, a very small increase in  $\Delta_s$  occurs for the other two  
 16 PBs with an increase in  $N_u$  until 30. A significant drop in  $\Delta_t$  is noted for all PBs as  $N_u$  increases  
 17 from 5 to 10, with only a slight reduction noted for other values. However, no change in  $\Delta_s$  and  $\Delta_t$   
 18 is observed for  $N_u = 30$  and  $40$ . Based on Fig. 7 and Table 1, it can be summarized that a finite  
 19 structure needs to have an adequate  $N_u$  to accurately replicate the attenuation and propagation  
 20 behavior of the corresponding infinite periodic structure.

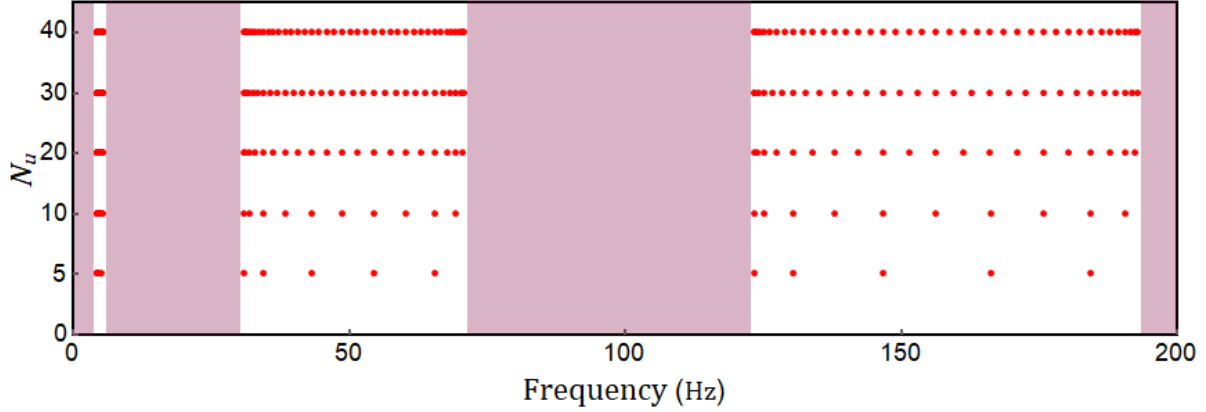

1

2 **Fig. 7.** Comparison of eigenfrequencies of  $P_1$  on rack for different values of  $N_u$ .

**Table 1**

Percentage difference in analytical and numerically determined PB bounding frequencies for  $P_1$ .

$N_u$	I <sup>st</sup> PB		II <sup>nd</sup> PB		III <sup>rd</sup> PB	
	$\Delta_s$ (%)	$\Delta_t$ (%)	$\Delta_s$ (%)	$\Delta_t$ (%)	$\Delta_s$ (%)	$\Delta_t$ (%)
5	0.29	5.32	0.03	8.36	0.89	5.71
10	0.17	1.45	0.07	2.34	0.91	2.23
20	0.17	0.28	0.09	0.76	0.91	1.29
30	0.17	0.02	0.10	0.36	0.91	1.10
40	0.17	0.02	0.10	0.36	0.91	1.10

3

Figure 8(a) shows the variation of  $T_r$  at four typical points along the length of pipe; 24 m, 84 m,

4

144 m, and 240 m from the excitation point. This corresponds to the right end of 4<sup>th</sup>, 14<sup>th</sup>, 24<sup>th</sup> and

5

40<sup>th</sup> span of  $P_1$ . It is evident that the attenuation level within each BG increases significantly when

6

moving away from the excitation point, reaching its maximum at 240 m. However, the number of

7

BGs and their positions is independent of the locations. Figure 8(b) depicts the comparison of  $T_r$

1 when 4, 14, 24 and 40 unit-cells are used in the FE model. Within each PB, the transmission peaks  
 2 are notably high and they remain consistent even for the smallest distance, while the number of  
 3 peaks varies with  $N_u$ .

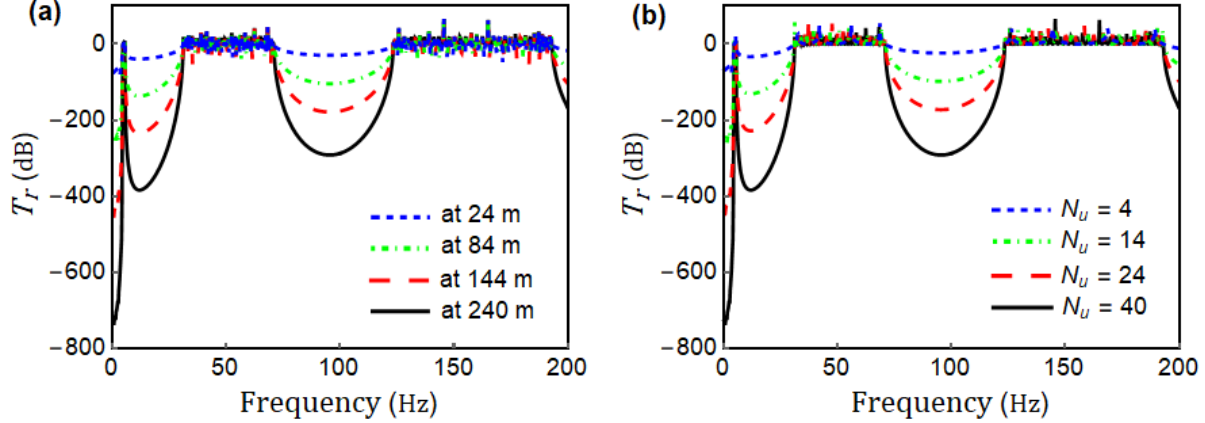

4  
 5 **Fig. 8.** Comparison of  $T_r$  for  $P_1$ : (a) At different location from excitation point; and (b) For  
 6 different values of  $N_u$ .

7 As the stiffness of the rack become extremely high ( $K_{pr} \rightarrow \infty$ ) and the lumped mass become  
 8 negligible ( $M_{pr} = 0$ ), coupled pipe-rack system reduces to a pipe supported on simple supports.  
 9 Substituting these conditions in Eq. (17) results in the following dispersion equation,

$$\cos(\kappa L) = 2 \left[ \frac{\Phi_2 \Phi_3 - \Phi_1 \Phi_4}{\Phi_3 - \Phi_4} \right] \quad (27)$$

10 Figures 9(a) and (b) respectively illustrates the  $\text{Re}(\pm\kappa_1 L)$  and  $\text{Im}(\pm\kappa_1 L)$  parts of the dispersion  
 11 relation based on Eq. (27), while Fig. 9(c) illustrates the variation of  $T_r$  from FE model. The  
 12 analytical and FE results exhibit good agreement with each other. The first two BGs are observed  
 13 at 0 – 31.10 Hz and 71.30 – 123.30 Hz. The principal difference in the dispersion characteristic  
 14 between the case with and without rack lie in the existence of an extra narrow PB located around

1 4.50 Hz in case of the former. The pipe supported on rack exhibits both resonance and Bragg-type  
 2 BGs, whereas only Bragg BGs appear with simple supports.

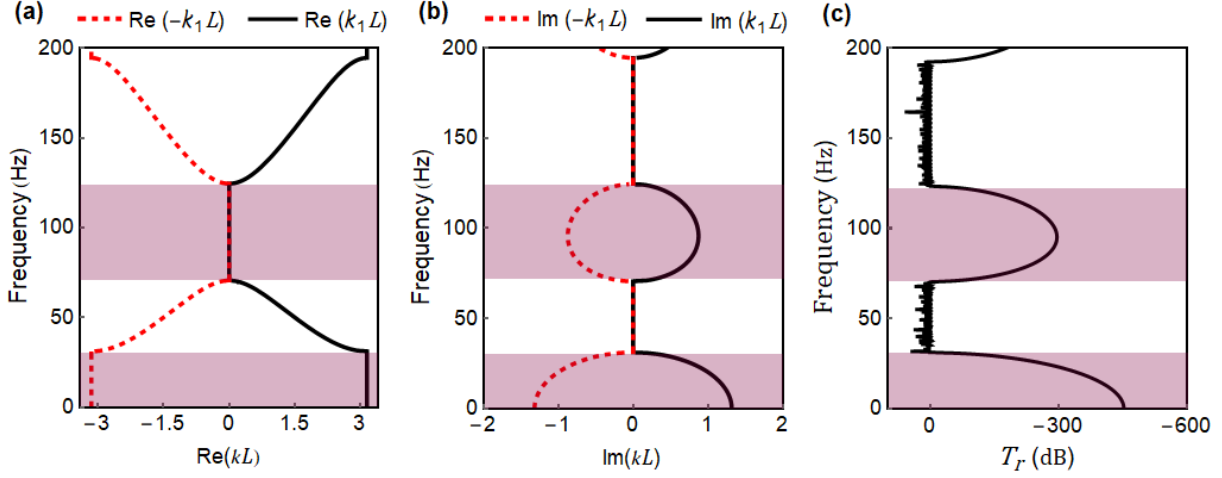

3  
 4 **Fig. 9.** Dispersion diagram and vibration transmission in pipe  $P_1$  with simple supports: (a)  
 5  $\text{Re}(\pm\kappa_1L)$ ; (b)  $\text{Im}(\pm\kappa_1L)$ ; and (c)  $T_r$  (dB).

### 6 3.2. Vibration control in dual pipelines

7 The propagation and attenuation characteristics of uncontrolled  $P_1$  coupled with rack discussed in  
 8 the previous section shows the presence of wide PBs in the low frequency region. Herein, it is  
 9 aimed to control second PB (31.10 – 71.10 Hz). To achieve this, a SDoF DVA is connected with  
 10 the pipes  $P_1$  and  $P_2$  as illustrated in Fig. 2(b). For any value of  $\mu$ , the optimal stiffness ( $k_{1,\mu}$ ,  $k_{2,\mu}$ )  
 11 and damping ( $c_{1,\mu}$ ,  $c_{2,\mu}$ ) properties to be employed in the DVA are determined using GA given in  
 12 Section 2.3. The optimal parameters for DVA and the corresponding  $\Pi$  values are obtained for  
 13 three mass ratios ( $\mu = 10\%$ ,  $15\%$  and  $20\%$ ), and given in Table 2.

14 Figures 10(a) and (b) compare the  $T_r$  from uncontrolled  $P_1$  and  $P_2$  against controlled cases using  
 15 DVA for the three mass ratios. It can be observed from both Table 2 and Fig. 10 that the  
 16 performance of DVAs in the considered PB improves with an increase in  $\mu$ . A small value of  $\Pi$   
 17 indicates high vibration reduction capabilities in the controlled system and vice versa.

**Table 2**

Optimal properties of DVA.

Mass ratio (%)	Stiffness (N/m)		Damping (N – s/m)		Objective function
$\mu$	$k_{1,\mu}$	$k_{2,\mu}$	$c_{1,\mu}$	$c_{2,\mu}$	$\Pi$
10	2.87E6	6.53E3	4.98E3	3.77E2	6.59E-4
15	4.23E6	5.31E4	1.38E4	4.38E2	2.49E-4
20	4.14E6	1.07E6	7.24E3	8.77 E3	4.09E-5

1

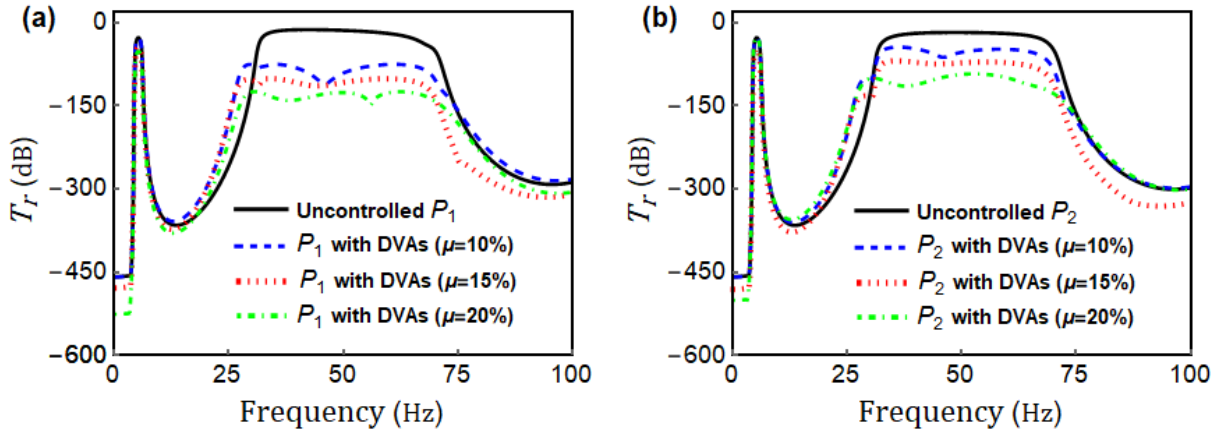

2

3 **Fig. 10.** Comparison of  $T_r$  in uncontrolled pipe against pipe controlled using DVAs with different  
4  $\mu$ : (a)  $P_1$ ; (b)  $P_2$ .

### 5 3.3 Efficacy of designed DVA

6 To assess the effectiveness of the designed DVA, its performance is compared to that of the pipe  
7 endowed with conventional TMD of the same mass ratio. The optimal values of  $k_\mu$  and  $c_\mu$  in case  
8 of TMD with  $\mu = 10\%$  are obtained using optimization as 1.16 E6 N/m and 7.40E3 N – s/m,  
9 respectively. The corresponding  $\Pi$  is 4.98E-5. Figure 11 compares the  $T_r$  of uncontrolled  $P_1$   
10 against  $P_1$  with DVAs and TMDs. As evident from Fig. 11 and the value of  $\Pi$ , the performance of

1 TMD is slightly better than the DVA. However, the principal advantage of the DVA is that a single  
 2 mass can simultaneously control the two pipes, while a conventional TMD with a single mass can  
 3 control only that pipe to which it is attached.

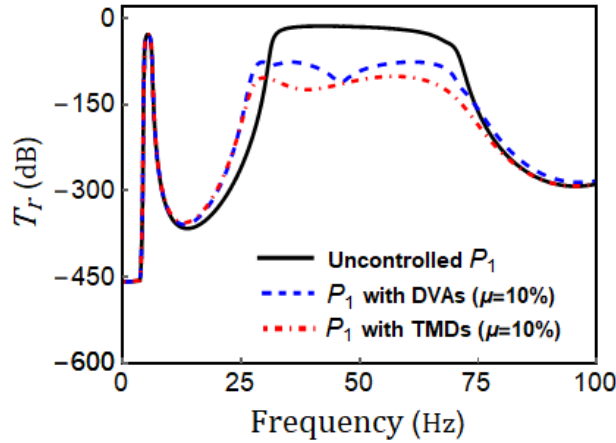

4  
 5 **Fig. 11.** Comparison of  $T_r$  in uncontrolled  $P_1$  against  $P_1$  controlled using DVAs and conventional  
 6 TMDs for  $\mu = 10\%$ .

7 Further, to test the effectiveness of the designed DVAs, a random white Gaussian noise (with zero-  
 8 mean and unit standard deviation) rotation  $RY_{i/p}$  is imposed at the left end of  $P_1$ , and the resulting  
 9 output  $RY_{o/p}$  is computed at the right end.  $RY_{i/p}$  is generated over a duration of 3 s with a step of  
 10  $2E - 3$  s. This results in flexural waves to propagate through the pipe, thereby showcasing its band  
 11 gap characteristics. Similar flexural wave propagation at different frequencies happens when units  
 12 such as compressors and pumps are connected to either end of the pipe or from impacts. This is  
 13 different from seismic or wind loads which follow a different mechanism. A specific realization  
 14 of  $RY_{i/p}$  employed here is shown in Fig. 12(a), and its Fast Fourier Transform (FFT) is depicted  
 15 in Fig. 12(b).

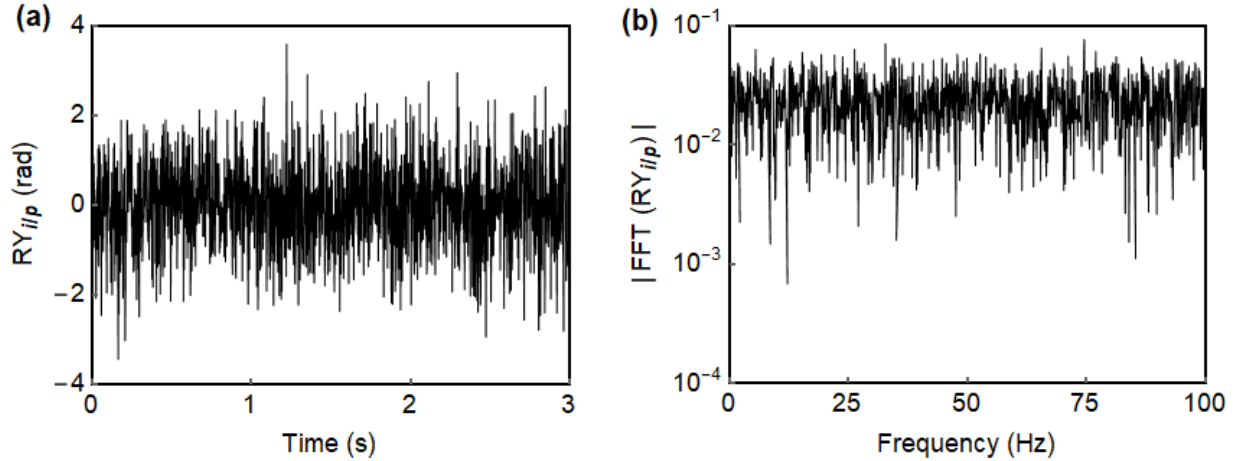

1

2 **Fig.12.**  $RY_{i/p}$  imposed at  $P_1$ : (a) Time history; and (b) FFT.

3 A dynamic time history analysis was performed using Newmark- $\beta$  method with integration  
 4 parameters  $\gamma = 1/2$  and  $\eta = 1/6$  [81]. Rayleigh damping was applied only to the pipe-rack  
 5 system and not for DVA. A damping ratio of  $\xi = 2\%$  was considered, and the damping  
 6 coefficients ( $\mathbf{C} = \alpha\mathbf{M} + \delta\mathbf{K}$ ) for both stiffness and mass were calculated based on a frequency  
 7 range of 0 – 71.10 Hz. The analysis is reported only for the case of  $\mu = 10\%$ , as other cases  
 8 showed similar patterns.

9 The time history response  $RY_{o/p}$  of uncontrolled and controlled pipes are depicted in Figs. 13(a-  
 10 c), and Fig. 13(d) compares their FFTs. It is evident from the time history plots that the designed  
 11 DVA can significantly reduce the vibration response of both pipes. The FFTs in Fig. 13(d) also  
 12 confirm this. It is also clear from the FFT plots that the DVA is efficient only in the designed  
 13 frequency range, and may not show the intended performance outside this range. Similar time  
 14 history and FFT responses are observed for pipes with TMDs; hence, they are not reported.



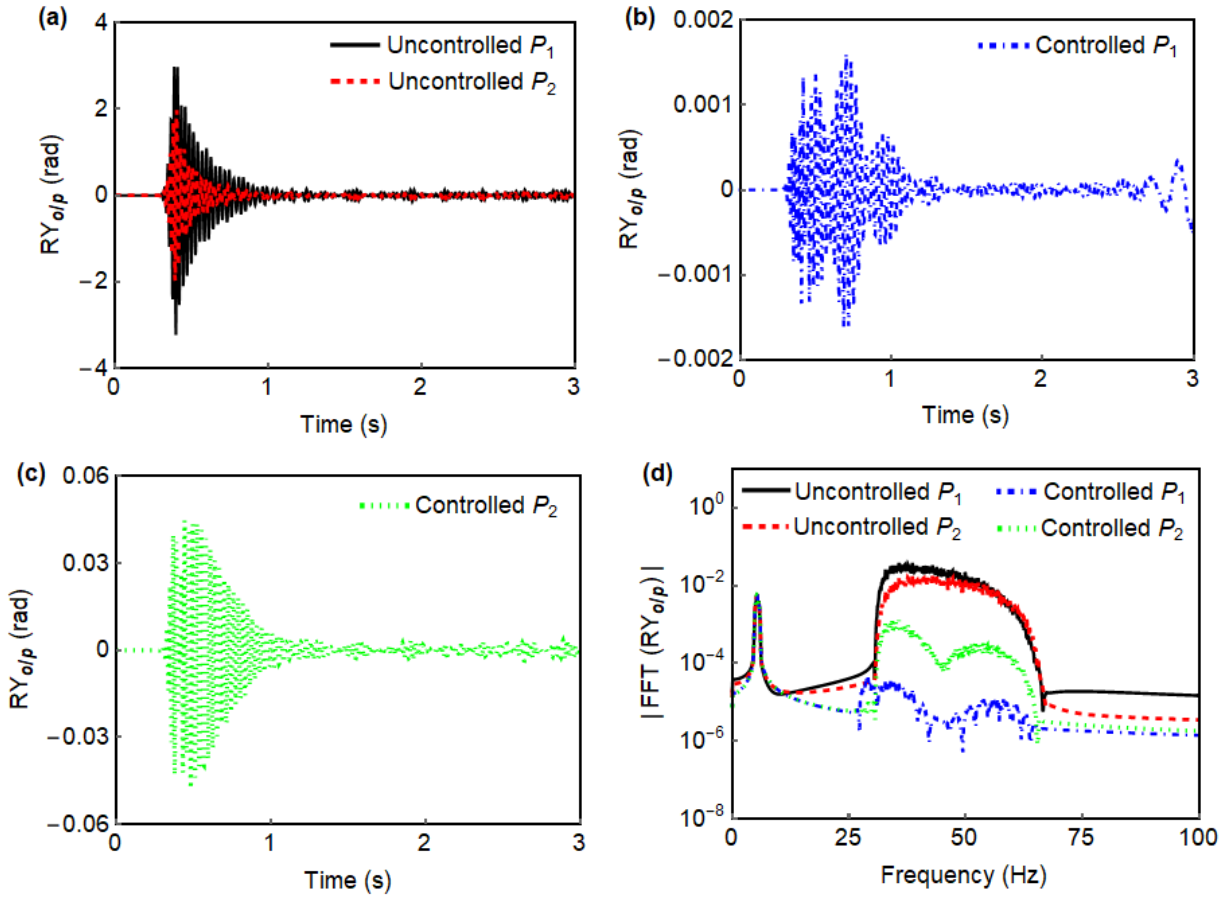

1  
 2 **Fig. 13.** Response time histories and FFT: (a) Uncontrolled  $P_1$  and  $P_2$ ; (b) Controlled  $P_1$ ; (c)  
 3 Controlled  $P_2$ ; and (d) Comparison of uncontrolled and controlled pipes FFTs.

#### 4. Conclusions

5 The study explored the behavior of flexural waves in pipes for two different scenarios; one with a  
 6 rack structure and the other featuring simple supports. The dispersion relations for both cases were  
 7 formulated using the transfer matrix method in combination with the Floquet-Bloch's theorem.  
 8 The resulting band gaps (BGs) and pass bands (PBs) in the considered frequency range were  
 9 validated using finite element models. Within the analyzed frequency range, pipe supported on  
 10 rack-structure displayed resonance and Bragg-type BGs, whereas only Bragg BGs were observed  
 11 in the pipe with simple supports. The modal analysis revealed that a finite structure requires an

1 adequate number of unit-cells to accurately replicate the behavior of an infinite periodic structure.  
2 It was observed that for a given number of spans, attenuation level within each BG increases with  
3 distance along the pipe. A similar enhancement in attenuation level was noted as the number of  
4 unit-cells increased.

5 Further, a novel method to control vibration in dual periodic pipelines was proposed, which  
6 involves connecting them with a dynamic vibration absorber (DVA) unit in each span. The optimal  
7 properties of DVA for different mass ratios were determined using GA based optimization. The  
8 performance of DVA increases with an increase in mass ratio. The proposed DVA effectively  
9 control vibration in the targeted PB. The performance of the DVA was also compared with the  
10 conventional tuned mass damper (TMD) of identical mass ratio. Although the performance of the  
11 TMD was slightly higher than the proposed DVA, the former can control only the pipe to which it  
12 is attached. In contrast, the DVA can control both pipes simultaneously. Furthermore, a time  
13 history analysis was conducted utilizing a white Gaussian noise on both uncontrolled and  
14 controlled cases, which confirmed the effectiveness of the designed DVA within the targeted  
15 frequency range.

16 The dispersion relation of flexural elements studied in the context of pipelines can be extended to  
17 other similar periodic structures. The innovative concept of interconnected DVA proposed in this  
18 study offers a promising and cost-effective solution applicable in scenarios involving secondary  
19 flexural systems parallel to the main flexural structure such as periodic railway tracks, closely  
20 spaced bridges, underwater tunnels, etc. Although significant efficiency was noted in controlling  
21 a particular PB using such mechanisms, the possibility of simultaneous control of multiple PBs,  
22 impact of fluid-structure interaction on BG properties, and the effectiveness of proposed technique  
23 under other realistic loading scenarios deserve further attention.

1 **Declaration of Competing Interest**

2 The authors declare that they have no known competing financial interests or personal  
3 relationships that could have appeared to influence the work reported in this paper.

4 **Acknowledgments**

5 This work was supported by the LABEX CeLyA, France (ANR-10-LABX-0060) of Université de  
6 Lyon, within the program “Investissements d’Avenir” operated by the French National Research  
7 Agency (ANR).

8 **References**

- 9 [1] Yan Y, Chai M. Sealing failure and fretting fatigue behavior of fittings induced by pipeline  
10 vibration. *Int J Fatigue* 2020;136:105602. <https://doi.org/10.1016/j.ijfatigue.2020.105602>.
- 11 [2] Bi K, Hao H (2016) Using pipe-in-pipe systems for subsea pipeline vibration control. *Eng*  
12 *Struct* 109:75–84. <https://doi.org/10.1016/j.engstruct.2015.11.018>.
- 13 [3] Iqbal M, Kumar A, Jaya MM, Bursi OS. Vibration control of periodically supported pipes  
14 employing optimally designed dampers. *Int J Mech Sci* 2022;234:107684.  
15 <https://doi.org/10.1016/j.ijmecsci.2022.107684>.
- 16 [4] Shen H, Wen J, Yu D, et al. Stability of fluid-conveying periodic shells on an elastic  
17 foundation with external loads. *J Fluids Struct* 2014;46:134–148.  
18 <https://doi.org/10.1016/j.jfluidstructs.2014.01.004>.
- 19 [5] Wang X, Wang MY. An analysis of flexural wave band gaps of locally resonant beams with  
20 continuum beam resonators. *Meccanica* 2016;51:171–178. [https://doi.org/10.1007/s11012-](https://doi.org/10.1007/s11012-015-0197-x)  
21 [015-0197-x](https://doi.org/10.1007/s11012-015-0197-x).

- 1 [6] Xiao L, Iqbal M, Yu X Quasi-static band gaps in metamaterial pipes with negative stiffness  
2 resonators. *Int J Mech Sci* 2023;261:108668.  
3 <https://doi.org/10.1016/j.ijmecsci.2023.108668>.
- 4 [7] Iqbal M, Kumar A, Jaya MM (2023) Analysis of Flexural Vibrations and Control of a  
5 Periodic Rail Track System. In: In: Shrikhande, M., Agarwal, P., Kumar PCA (eds) (ed)  
6 Proceedings of 17th Symposium on Earthquake Engineering. Springer Singapore,  
7 Singapore, pp 245–256.
- 8 [8] Iqbal M, Kumar A Flexural waves analysis and enhancement of bandgap properties of a  
9 periodic track structure. *Proc Inst Mech Eng Part E J Process Mech Eng* (2022).  
10 <https://doi.org/10.1177/09544089221145929>.
- 11 [9] Iqbal M, Kumar A Flexural Vibration Analysis and Improvement of Wave Filtering  
12 Capability of Periodic Pipes. *Mech Mach Sci* 125 MMS (2023):1049–1058.  
13 [https://doi.org/10.1007/978-3-031-15758-5\\_108](https://doi.org/10.1007/978-3-031-15758-5_108).
- 14 [10] Mead DJ. Vibration Response and Wave Propagation in Periodic Structures. *J Eng Ind*  
15 1970;93: 783–791.
- 16 [11] Gupta GS. Natural flexural waves and the normal modes of periodically supported beams  
17 and plates. *J Sound Vib* 1970;13:89–101.
- 18 [12] Singh K, Mallik AK. Wave propagation and vibration response of a periodically supported  
19 pipe conveying fluid. *J Sound Vib* 1977;54:55–66.
- 20 [13] Yu D, Wen J, Zhao H, et al. Vibration reduction by using the idea of phononic crystals in a  
21 pipe-conveying fluid. *J Sound Vib* 2008;318:193–205.  
22 <https://doi.org/10.1016/j.jsv.2008.04.009>.

- 1 [14] Iqbal M, Jaya MM, Bursi OS, et al. Flexural band gaps and response attenuation of periodic  
2 piping systems enhanced with localized and distributed resonators. *Sci Rep* 2020;10:1–11.  
3 <https://doi.org/10.1038/s41598-019-56724-0>.
- 4 [15] Pelat A, Gallot T, Gautier F. On the control of the first Bragg band gap in periodic  
5 continuously corrugated beam for flexural vibration. *J Sound Vib* 2019;446:249–262.  
6 <https://doi.org/10.1016/j.jsv.2019.01.029>.
- 7 [16] Ding L, Zhu H, Luo H, Yin T. Flexural wave propagation and localization in periodic jointed  
8 tunnels subjected to moving loads. *J Vib Control* 2016;22:2788–2804.  
9 <https://doi.org/10.1177/1077546314553318>.
- 10 [17] Zhao P, Yuan L, Ma T, Wei H. Study on Tunable Band Gap of Flexural Vibration in a  
11 Phononic crystals 2021;11:1–12.
- 12 [18] Sorokin S V, Broberg PH, Steffensen MT, Ledet LS. Finite element modal analysis of wave  
13 propagation in homogeneous and periodic waveguides. *Int J Mech Sci* 2022;227:107444.  
14 <https://doi.org/10.1016/j.ijmecsci.2022.107444>.
- 15 [19] Carta G, Giaccu GF, Brun M. A phononic band gap model for long bridges. The ‘Brabau’  
16 bridge case. *Eng Struct* 2017;140:66–76. <https://doi.org/10.1016/j.engstruct.2017.01.064>.
- 17 [20] Guo W, Nie R, Zhu X, et al. Flexural wave band gaps in periodic bi-directionally orthogonal  
18 stiffened plates with holes. *Int J Struct Stab Dyn* 2022;22:1–22.  
19 <https://doi.org/10.1142/S0219455422501838>.
- 20 [21] Iqbal M, Kumar A, Bursi OS (2021) Vibration Control of a Periodic Piping System  
21 Employing Metamaterial Concept. 2021 15th Int Congr Artif Mater Nov Wave Phenomena,  
22 *Metamaterials* 2021 167–169. <https://doi.org/10.1109/Metamaterials52332.2021.9577113>

- 1 [22] Cai C, Zhou J, Wang K, et al. Quasi-zero-stiffness metamaterial pipe for low-frequency  
2 wave attenuation. *Eng Struct* 2023;279:115580.  
3 <https://doi.org/10.1016/j.engstruct.2022.115580>.
- 4 [23] Li J, Yang P, Li S. Multiple band gaps for efficient wave attenuation by inertial amplification  
5 in periodic functionally graded beams. *Compos Struct* 2021;271:114130.  
6 <https://doi.org/10.1016/j.compstruct.2021.114130>.
- 7 [24] Burlon A, Failla G. On the band gap formation in locally-resonant metamaterial thin-walled  
8 beams. *Eur J Mech / A Solids* 2023;97:104798.  
9 <https://doi.org/10.1016/j.euromechsol.2022.104798>.
- 10 [25] Chen H, Li XP, Chen YY, Huang GL. Wave propagation and absorption of sandwich beams  
11 containing interior dissipative multi-resonators. *Ultrasonics* 2017;76:99–108.  
12 <https://doi.org/10.1016/j.ultras.2016.12.014>.
- 13 [26] Wang Q, Li J, Zhang Y, et al. Bandgap properties in metamaterial sandwich plate with  
14 periodically embedded plate-type resonators. *Mech Syst Signal Process* 2021;151:107375.  
15 <https://doi.org/10.1016/j.ymsp.2020.107375>.
- 16 [27] Tang L, Cheng L, Chen K. Complete sub-wavelength flexural wave band gaps in plates with  
17 periodic acoustic black holes. *J Sound Vib* 2021;502:116102.  
18 <https://doi.org/10.1016/j.jsv.2021.116102>.
- 19 [28] Li L, Chen T, Wang X, Li B. One-dimensional Bi-stage phononic band gap shaft structure  
20 for reducing torsional vibration. *Appl Mech Mater* 2012;141:54–58.  
21 <https://doi.org/10.4028/www.scientific.net/AMM.141.54>.

- 1 [29] Song Y, Wen J, Yu D, Wen X. Analysis and enhancement of torsional vibration stopbands  
2 in a periodic shaft system. *J Phys D Appl Phys* 2013;46:. [https://doi.org/10.1088/0022-](https://doi.org/10.1088/0022-3727/46/14/145306)  
3 [3727/46/14/145306](https://doi.org/10.1088/0022-3727/46/14/145306).
- 4 [30] Iqbal M, Kumar A, Murugan Jaya M, Bursi OS. Flexural band gaps and vibration control of  
5 a periodic railway track. *Sci Rep* 2021;11:1–13. [https://doi.org/10.1038/s41598-021-97384-](https://doi.org/10.1038/s41598-021-97384-3)  
6 [3](https://doi.org/10.1038/s41598-021-97384-3).
- 7 [31] Yang C, Kaynardag K, Salamone S. Investigation of wave propagation and attenuation in  
8 periodic supported rails using wave finite element method. *Acta Mech* 2023;235: 1453–  
9 1469. <https://doi.org/10.1007/s00707-023-03484-8>.
- 10 [32] Li H, Li Y, Liu X. Double-beam metastructure with inertially amplified resonators for  
11 flexural wave attenuation. *Eur J Mech / A Solids* 2023;97:104794.  
12 <https://doi.org/10.1016/j.euromechsol.2022.104794>.
- 13 [33] Zhao C, Zhang K, Zhao P, et al. Bandgap merging and backward wave propagation in inertial  
14 amplification metamaterials. *Int J Mech Sci* 2023;250:108319.  
15 <https://doi.org/10.1016/j.ijmecsci.2023.108319>.
- 16 [34] Lee S, Ahn CH, Lee JW. Vibro-acoustic metamaterial for longitudinal vibration suppression  
17 in a low frequency range. *Int J Mech Sci* 2018;144:223–234.  
18 <https://doi.org/10.1016/j.ijmecsci.2018.05.010>.
- 19 [35] Xiao L, Bursi OS, Wang M, et al. Metamaterial beams with negative stiffness absorbers and  
20 rotation: band-gap behavior and band-gap merging. *Eng Struct* 2023;280:115702.  
21 <https://doi.org/10.1016/j.engstruct.2023.115702>.

- 1 [36] Li Q, Sheng M. An improved method for bandgap calculation of a locally resonant plate  
2 with multi-periodic of multiple degree-of-freedom resonators. *J Appl Phys* 2021;129:.  
3 <https://doi.org/10.1063/5.0045424>.
- 4 [37] Liang F, Xu WH, Chen ZQ (2023) Flexural–torsional vibration reduction of an eccentric  
5 phononic crystal pipe conveying fluid. *J Fluids Struct* 120:103904.  
6 <https://doi.org/10.1016/j.jfluidstructs.2023.103904>.
- 7 [38] Wu J, Sun Y, Su M, Zhu H. Fluid-structure interaction and band gap analysis of periodic  
8 composite liquid-filled pipe. *Compos Struct* 2023;304:116444.  
9 <https://doi.org/10.1016/j.compstruct.2022.116444>.
- 10 [39] Liang F, Yang X (2020) Wave properties and band gap analysis of deploying pipes conveying  
11 fluid with periodic varying parameters. *Appl Math Model* 77:522–538.  
12 <https://doi.org/10.1016/j.apm.2019.07.064>.
- 13 [40] Yu H, Liang F, Qian Y, et al (2021) Phononic band gap and free vibration analysis of fluid-  
14 conveying pipes with periodically varying cross-section. *Appl Sci* 11:1–18.
- 15 [41] Ni A, Shi Z, Meng Q, Lim CW. A novel buried periodic in-filled pipe barrier for Rayleigh  
16 wave attenuation: Numerical simulation, experiment and applications. *Eng Struct*  
17 2023;297:116971. <https://doi.org/10.1016/j.engstruct.2023.116971>.
- 18 [42] Liang F, Chen Y, Gong J, Qian Y (2022) Vibration self-suppression of spinning fluid-  
19 conveying pipes composed of periodic composites. *Int J Mech Sci* 220:107150.  
20 <https://doi.org/10.1016/j.ijmecsci.2022.107150>.
- 21 [43] Wu JH, Zhu HZ, Sun YD, et al. Torsional Wave Propagation and Vibration Reducing of  
22 Phononic Crystal Pipe with Periodic Torsional Support. *J Press Vessel Technol Trans ASME*  
23 2023;145:1–9. <https://doi.org/10.1115/1.4055066>.



- 1 [44] Liang F, Chen Z, Xu W (2023) Vibration isolation of a self-powered piezoelectric pipe  
2 conveying fluid composed of laminated fiber-reinforced composites. *Appl Ocean Res*  
3 138:103664. <https://doi.org/10.1016/j.apor.2023.103664>.
- 4 [45] Bu Y, Tang Y, Ding Q. Novel vibration self-suppression of periodic pipes conveying fluid  
5 based on acoustic black hole effect. *J Sound Vib* 2023;567:118077.  
6 <https://doi.org/10.1016/j.jsv.2023.118077>.
- 7 [46] Geng Q, Zhao G, Yang X, et al (2024) Flexural vibration suppression behavior of sleeved  
8 phononic crystal pipes in thermal environment. *Eng Struct* 309:118011.  
9 <https://doi.org/10.1016/j.engstruct.2024.118011>.
- 10 [47] Plisson J, Pelat A, Gautier F, et al. Experimental evidence of absolute bandgaps in phononic  
11 crystal pipes. *Appl Phys Lett* 2020;116:201902. <https://doi.org/10.1063/5.0007532>.
- 12 [48] Fernandes R, El-borgi S, Yazbeck R, et al. Non-dimensional analysis of the bandgap  
13 formation in a locally resonant metamaterial pipe conveying fluid. *Appl Math Model*  
14 2022;106:241–258. <https://doi.org/10.1016/j.apm.2021.12.036>.
- 15 [49] Liang F, Chen Y, Kou H, Qian Y. Hybrid Bragg-locally resonant bandgap behaviors of a  
16 new class of motional two-dimensional meta-structure. *Eur J Mech / A Solids*  
17 2023;97:104832. <https://doi.org/10.1016/j.euromechsol.2022.104832>.
- 18 [50] Matos PHMC, Neves DA, Vieira SC, et al. Analytical and experimental investigation of  
19 flexural waves in horizontal pipes conveying two-phase periodic intermittent flow. *Appl*  
20 *Acoust* 2022;192:108714. <https://doi.org/10.1016/j.apacoust.2022.108714>.
- 21 [51] El-borgi S, Alrumaihi A, Rajendran P, et al. Model updating of a scaled piping system and  
22 vibration attenuation via locally resonant bandgap formation. *Int J Mech Sci*  
23 2021;194:106211. <https://doi.org/10.1016/j.ijmecsci.2020.106211>.

- 1 [52] Iqbal M, Kumar A, Bursi OS. Lateral flexural vibration reduction in a periodic piping system  
2 enhanced with two-degrees-of-freedom resonators. *Proc Inst Mech Eng Part L J Mater Des*  
3 *Appl* 2021;0:1–11. <https://doi.org/10.1177/14644207211027603>.
- 4 [53] Lyu X, Chen F. Ultra-thin Piezoelectric Lattice for Vibration Suppression in Pipe Conveying  
5 Fluid. *Acta Mech Solida Sin* 2020;33:770–780. <https://doi.org/10.1007/s10338-020-00174->  
6 [z](https://doi.org/10.1007/s10338-020-00174-z).
- 7 [54] Liu J, Yu D, Zhang Z, et al. Flexural Wave Bandgap Property of a Periodic Pipe with Axial  
8 Load and Hydro-Pressure. *Acta Mech Solida Sin* 2019;32:173–185.  
9 <https://doi.org/10.1007/s10338-018-0070-2>.
- 10 [55] Yu D, Wen J, Shen H, Wen X (2012) Propagation of steady-state vibration in periodic pipes  
11 conveying fluid on elastic foundations with external moving loads. *Phys Lett A* 376:3417–  
12 3422. <https://doi.org/10.1016/j.physleta.2012.09.041>.
- 13 [56] Scutтери S, Russillo AF, Santoro R, et al (2024) An inerter-based concept of locally resonant  
14 fluid-conveying pipe. *Eur J Mech A/Solids* 106:105316.  
15 <https://doi.org/10.1016/j.euromechsol.2024.105316>.
- 16 [57] Wu J, Sun Y, Su M, et al. Band gap analysis of composite fluid-filled pipe with periodically  
17 axial support or dynamic vibration absorbers. *Mech Adv Mater Struct* 2022;0:1–9.  
18 <https://doi.org/10.1080/15376494.2022.2088908>.
- 19 [58] Frahm, H. Device for damping vibrations of bodies. US Patent US 989958A (1909).
- 20 [59] Ormondroyd J, Den Hartog JP. The theory of the dynamic vibration absorber. *Trans Am*  
21 *Soc.Mech Eng* 1928;50, 9–22.
- 22 [60] Su N, Chen Z, Xia Y, Bian J (2024) Hybrid analytical H-norm optimization approach for  
23 dynamic vibration absorbers. *Int J Mech Sci* 264:108796.

- 1        <https://doi.org/10.1016/j.ijmecsci.2023.108796>.
- 2 [61] Warburton GB. Optimum absorber parameters for various combinations of response and  
3        excitation parameters. *Earthq Eng Struct D* 1982;10, 381–401.
- 4 [62] Warburton GB, Ayorinde EO. Optimum absorber parameters for simple systems. *Earthq Eng*  
5        *Struct D* 1980;8, 197–217.
- 6 [63] Bisegna P, Caruso G (2012) Closed-form formulas for the optimal pole-based design of tuned  
7        mass dampers. *J Sound Vib* 331:2291–2314. <https://doi.org/10.1016/j.jsv.2012.01.005>.
- 8 [64] Argenziano M, Faiella D, Carotenuto AR, et al (2022) Generalization of the Den Hartog  
9        model and rule-of-thumb formulas for optimal tuned mass dampers. *J Sound Vib*  
10        538:117213. <https://doi.org/10.1016/j.jsv.2022.117213>.
- 11 [65] Murugan Jaya M, Ceravolo R, Matta E, Fragonara LZ. A resonating lattice TMD to reduce  
12        pipeline vibrations. In American Society of Mechanical Engineers, Pressure Vessels and  
13        Piping Division (Publication) PVP (2018).
- 14 [66] Frans R, Arfiadi Y. Designing optimum locations and properties of MTMD systems. In  
15        *Procedia Engineering* 892–898 (2015).
- 16 [67] Arfiadi Y, Hadi MNS. Optimum placement and properties of tuned mass dampers using  
17        hybrid genetic algorithms. *Int J Optim Civ Eng* 2011;1, 167–187.
- 18 [68] Norris MA, Ptak KR, Zamora BA, Hart JD. Implementation of Tuned Vibration Absorbers  
19        for Above Ground Pipeline Vibration Control. 3rd International Pipeline Conference,  
20        IPC2000-115.
- 21 [69] Hart DJ, Sause R, Ford GW Brown LD. Pipeline vibration damper. US Patent US 5193644A  
22        (1991).
- 23 [70] Song GB, zhang P, Li LY, Singla M. Vibration control of a pipeline structure using  
24        pounding tuned mass damper. *J Eng Mech* 2016;142:1–10.

- 1 [71] Barutzki F, Gurr-Beyer C, Hinz G, Kerkhof K, Schwenkkros J. Identification and Reduction  
2 of Piping Vibrations under Different Conditions. VCE Vienna Consulting Engineers ZT  
3 GmbH, Vienna.
- 4 [72] Bursi OS, Filippo R, Salandra V La, et al. Probabilistic seismic analysis of an LNG subplant.  
5 J Loss Prev Process Ind 2018;53:45–60. <https://doi.org/10.1016/j.jlp.2017.10.009>.
- 6 [73] Floquet G. Sur les équations différentielles linéaires à coefficients périodiques. Ann Sci  
7 l'Ecole Norm Sup'erieure 1883;12:47–88.
- 8 [74] Bloch F. Über die Quantenmechanik der Elektronen in Kristallgittern. Zeitschrift für Phys  
9 1928;52:555–600. <https://doi.org/https://doi.org/10.1007/BF01339455>.
- 10 [75] Iqbal M, Kumar A (2023) Analysis of bending waves and parametric influence on band gaps  
11 in periodic track structure. Mater Today Proc. <https://doi.org/10.1016/j.matpr.2023.08.364>.
- 12 [76] Ansys® Academic Research Version 2020 R2, ANSYS, Inc. [www.ansys.com](http://www.ansys.com).
- 13 [77] Kumar RK, Kumar A (2023) Vibration attenuation of a beam supporting an unbalanced rotor  
14 using nonlinear energy sink. J Brazilian Soc Mech Sci Eng 6:1–14.  
15 <https://doi.org/10.1007/s40430-023-04064-6>.
- 16 [78] De-Jong KA. Analysis of the behavior of a class of genetic adaptive systems. Ph.D. Thesis,  
17 University of Michigan, 1975.
- 18 [79] Goldberg DE Genetic Algorithms in Search, Optimization and Machine Learning (Addison-  
19 Wesley Publishing Company, 1989).
- 20 [80] Murugan Jaya M Vibration monitoring and control of industrial structures', PhD Thesis,  
21 Politecnico di Torino, 2020.
- 22 [81] Chopra AK Dynamics of structures, 3rd ed. (Prentice Hall, 2006)