



HAL
open science

Strategic Support Systems for Crisis Management: A Literature Review

Sidahmed Elandaloussi, Pascale Zaraté

► **To cite this version:**

Sidahmed Elandaloussi, Pascale Zaraté. Strategic Support Systems for Crisis Management: A Literature Review. Foundations and Trends® in Information Systems, 8 (1), Now Publishers, pp.1-65, 2024, 978-1-63828-392-8. 10.1561/29000000025 . hal-04712183

HAL Id: hal-04712183

<https://hal.science/hal-04712183v1>

Submitted on 30 Sep 2024

HAL is a multi-disciplinary open access archive for the deposit and dissemination of scientific research documents, whether they are published or not. The documents may come from teaching and research institutions in France or abroad, or from public or private research centers.

L'archive ouverte pluridisciplinaire **HAL**, est destinée au dépôt et à la diffusion de documents scientifiques de niveau recherche, publiés ou non, émanant des établissements d'enseignement et de recherche français ou étrangers, des laboratoires publics ou privés.

Strategic Support Systems for Crisis Management: A Literature Review

Elandaloussi Sidahmed¹ and Zaraté Pascale²

¹*Toulouse Capitole University, IRIT, France; sid.elandaloussi@irit.fr*

²*Toulouse Capitole University, IRIT, France; pascale.zarate@irit.fr*

ABSTRACT

This monograph presents a literature review of Strategic Decision Support Systems (SDSS) used in various fields such as transport, trade, logistics, medicine and education. The main objective of these systems is to provide information to decision makers to mitigate various influences. The chosen case study of this monograph is COVID-19 crisis management, which is an example that has an impact on sectors such as health, education, economy, the environment, and others. It aims to identify critical dependencies and how to develop efficient solutions. In particular, this monograph explores the problem of support for the strategic planning decision making during COVID-19 crisis management.

Keywords: Strategic decision support systems; COVID-19 crisis management; Strategic planning; Strategic management; Generative AI.

1

Introduction

Crisis management is a strategy-based approach by implementing certain steps to reduce an unanticipated event's negative effects or any negative disruption with the potential to harm business processes, people or property. There are several types of crises that have appeared in recent years: Technological crisis (Google in December 2020), Organizational crisis (Wells Fargo in 2020), and Natural crisis (COVID-19 in December 2019). COVID-19 is a complex catastrophe that has caused immense disruption across the globe. The first case of coronavirus was reported on December 1st, 2019, in Wuhan, China before expanding to the rest of the world in early 2020. During this time, countries have reacted differently to the COVID-19 pandemic.

On the one hand, the ongoing COVID-19 pandemic has had a significant impact on the economic development of various countries (Meyer *et al.*, 2022). Regarding SMEs (Small Medium Enterprises) crisis strategy, Klyver and Nielsen (2021) provide some preliminary empirical evidence on the most promising crisis strategies to manage the COVID-19 crisis. Several solutions have been suggested during the COVID-19 pandemic, as well as several innovations (Sharmaa *et al.*, 2022; Brem *et al.*, 2021; Lee *et al.*, 2020). Sharmaa *et al.* (2022) proposes

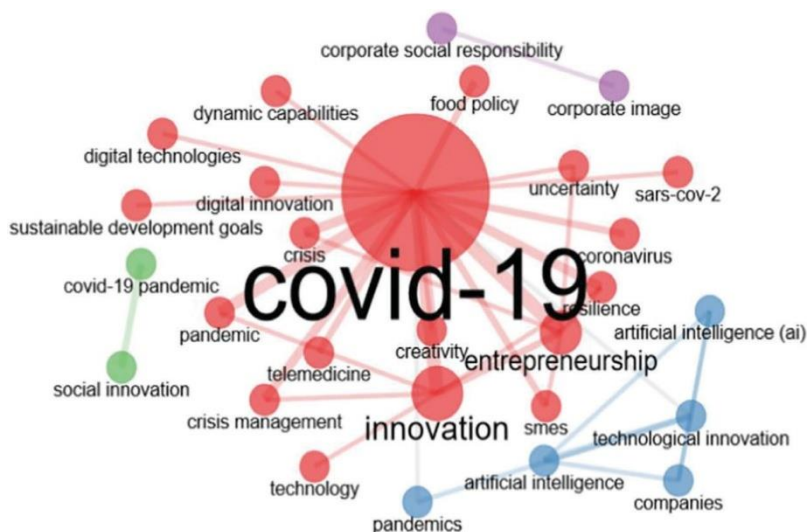

Figure 1.1: Used methodology for searching and selecting papers.

a quantitative approach by filtering papers in the Scopus database using keywords related to innovation in the time of COVID-19, and through the use of the Bibliometrics R-tool in order to emphasize the importance of innovation during the pandemic. Figure 1.1 represents an overview of the keywords network analysis where the larger nodes represent the more frequent occurrence and the lines connecting these nodes show co-occurrences.

Social media allowed organizations and governments to deal with the crisis in the early stage of the pandemic. Chon and Kim (2022) proposed a theory-grounded framework for using social media analytics during the early stages of the COVID-19 pandemic in the U.S to investigate how a potential issue becomes a government crisis. An overview of their study is shown in Figure 1.3. This study presents a model emphasizing the role of issues management in the digital age. It is defined by Chon and Kim (2022) and it is based on the public relations model of strategic management (Grunig *et al.*, 2002).

On the other hand, since the pandemic's breakout the artificial intelligence (Ahmad *et al.*, 2022; Chamola *et al.*, 2020) as well as data analytic technologies (Shahparvari *et al.*, 2022; Wamba *et al.*, 2020)

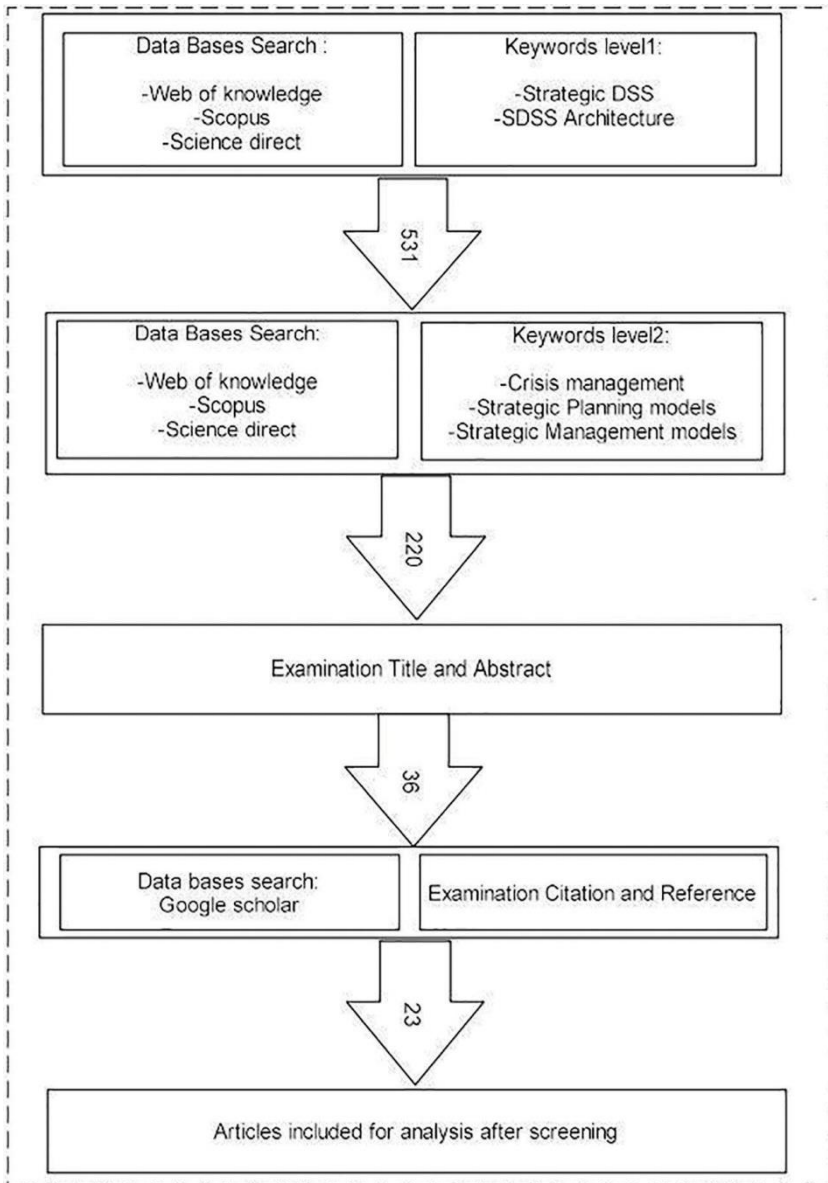

Figure 1.2: Keywords network analysis map (Sharmaa *et al.*, 2022).

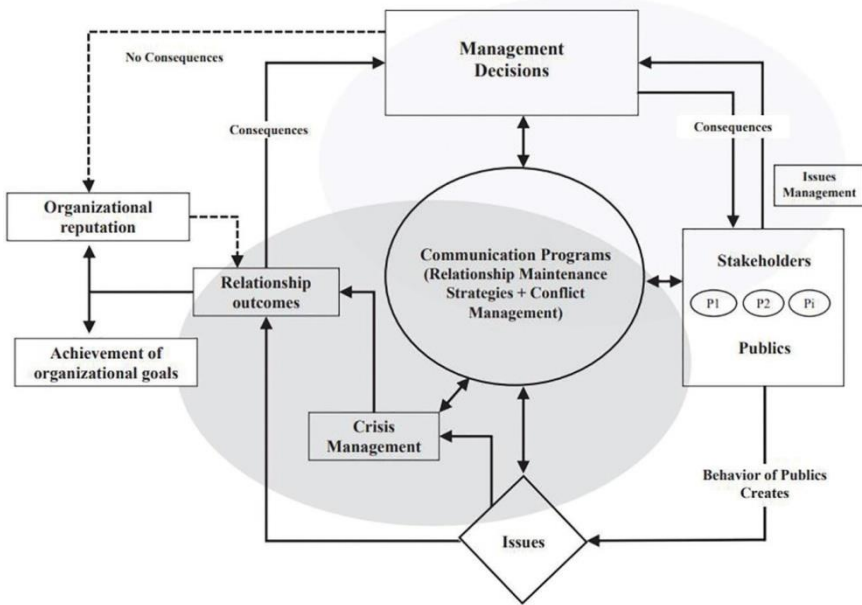

Figure 1.3: Model of strategic management of public relations (Chon and Kim, 2022).

have opened up new possibilities to assist in scientific research and create a wide variety of relevant data. Ahmad *et al.* (2022) proposed an improved convolutional neural network (**CNN**) model for the detection of COVID-19 disease from chest X-ray images leveraged by a human-machine system using deep learning techniques.

Since this period, there exists a growing body of literature on crisis management. For instance, Aussilloux *et al.* (2021) presents a report that defines a thorough comparison and in-depth analysis of the emergency and recovery plans announced by European countries.

However, so far, Strategic Decision Support Systems (**SDSS**) have become important despite deployment complexity, and have been widely incorporated in many specialized areas like the medical domain (Shahparvari *et al.*, 2022), logistics (Kamariotou *et al.*, 2017; Henrik *et al.*, 2008), transport (Barfod and Salling, 2015), and industry (Agostino *et al.*, 2020), and with several terminologies such as strategic management (Bader and Alyoubi, 2015), strategic planning (Tunčikiene' *et al.*, 2010),

etc. In this monograph, we present a literature review of SDSS, their general concepts, and how they were incorporated during the COVID-19 pandemic to help managers make decisions. This monograph is an extended version of Elandaloussi and Zaraté (2023), including a detailed analysis of COVID-19 pandemic management. Elandaloussi and Zaraté (2023) define a literature review to enable SDSS for crisis management. Defining the research question involves analyzing the literature review on Strategic Decision Support Systems (SDSS) and crisis management during the COVID-19 pandemic. This process helps identify connections and overlaps between these two areas. By understanding how SDSS has been used in managing crises like the COVID-19 pandemic, we can better formulate a focused and relevant research question.

The rest of this monograph is divided into seven sections as follows. We begin by discussing a comprehensive methodology for the literature review. Then, we offer an overview of our study background. Section 4 is devoted to discussing a brief description of the most important studies in SDSS technologies. In Section 5 SDSS models are presented. Next, we explore the application of generative AI, specifically ChatGPT, in the context of pandemic decision support systems by highlighting its role during the COVID-19 pandemic. Section 7 encompasses a brief discussion of our conducted surveys. Finally, in Section 8 we summarize the study and point out some concluding remarks.

2

Literature Review Methodology

This section describes the methodology adopted for the selection of articles and journals. These include SDSS technologies and their integration into crisis management tasks, for instance with COVID-19 pandemic. In this regard, we filter the papers to retain only the journal and conference articles in English related to the SDSS fields, in order to provide a structured literature review.

We searched for articles related to SDSS that appeared only in 4 data sources: ScienceDirect, Google Scholar, Web of Knowledge and Scopus. For the search criteria, we used the following keywords and terminology: “Strategic Decision Support Systems”, “Strategic Management models”, “Strategic planning models”, “SDSS”, “Crisis management Covid-19”.

Some different keywords have been more widely incorporated in various fields such as supply chain management (Ye *et al.*, 2022), crisis management (Jaziri and Miralama, 2021), etc. When the search was completed in all previous databases, we proceeded as follows:

- For each selected paper, the titles and abstracts were scanned.
- For each relevant paper, the citations and references were reviewed.

Utilizing this method enabled us to identify 23 articles deemed relevant to our literature review. Following a thorough examination of these articles, we proceeded to select additional articles for inclusion in our survey. Figure 1.2 shows an overview of the methodology used for searching and selecting papers to filter only relevant articles. Furthermore, the findings of the papers are presented in this present study.

3

Study Background

The COVID-19 pandemic has caused the most sudden and deepest global recession since the Second World War. The current crisis is different from all past recessions. It is complex and multidimensional, impacting various aspects of society, economy, healthcare, and individual lives. What follows are some of the dimensions contributing to its complexity.

- **Economic Impact:** The pandemic has caused significant economic disruption (Warwick and Fernando, 2023), with businesses closing, layoffs, and supply chain interruptions leading to financial instability for many individuals and organizations. For example, in France, on the eve of the second lockdown in October 2020, economic activity had recovered to an average of 96% of the pre-crisis level, but some services, such as catering, tourism, in-person services and the production of transport equipment are likely to be durably affected. This crisis is characterized by the scale of the emergency support measures for the economy. In 2020, France announced emergency support measures for up to 468 billion euros. The public deficit is forecasted at 11.3%, the financing of which will be facilitated by unprecedented decisions by the European Central Bank. By comparison, the 2009 crisis led to a

public deficit in France of around 7.2% in 2009. The scale of the stimulus measures, in addition to the emergency measures, is also unprecedented. An equally unprecedented policy response was the European Commission's issuance of debt on behalf of the EU, to finance a European recovery plan worth 750 billion euros.

- **Healthcare System Strain:** The pandemic has placed immense pressure on healthcare systems worldwide (Yu-Pei *et al.*, 2023), leading to overwhelmed hospitals, shortage of medical supplies, and burnout among healthcare workers.
- **Social Effects:** Lockdowns, social distancing measures (Al-Maseb *et al.*, 2023), and travel restrictions have led to social isolation, mental health issues, and disruptions to education, employment, and social interactions.
- **Global Response and Cooperation:** The pandemic has highlighted the importance of global cooperation in addressing public health crises, but it has also exposed gaps in coordination and solidarity among nations.
- **Vaccine Development and Distribution:** The rapid development of vaccines (Komathi *et al.*, 2024) has been a significant milestone, but challenges remain in ensuring equitable distribution, addressing vaccine hesitancy, and adapting to new variants of the virus.
- **Misinformation:** The proliferation of misinformation (Stephen and Witkowski, 2024) and conspiracy theories has complicated public health efforts, leading to confusion, mistrust, and reluctance to adopt preventive measures or vaccination.

Managing this pandemic can be seen as a strategic issue. Dung and Giang (2021) identifies hotels' strategic responses to five COVID-19 pandemic phases, guided by an integrated crisis management framework, as provided in Figure 3.1, by refining the pandemic crisis management model within the context of the hotel sector based on global hotels' strategic responses. Other studies such as Shahparvari *et al.* (2022) and

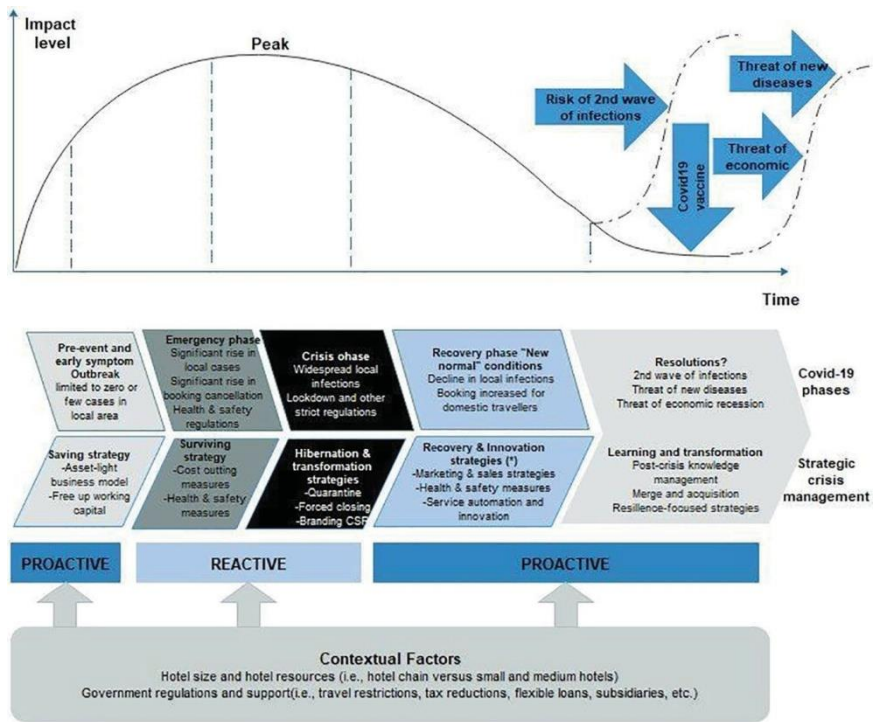

Figure 3.1: A strategic framework of hotel pandemic crisis management (Dung and Giang, 2021).

Chon and Kim (2022) have also dealt with this issue. For instance, the objective of the proposed solution in Shahparvari *et al.* (2022) is to identify, locate, and prioritize people who need vaccination by screening attributes including health condition, age, and population density using spatial analytical methods. Furthermore, with the increasing use of social media, Chon and Kim (2022) have used this to monitor, analyze and listen to the public in order to detect potential threats during COVID-19 pandemic. In the next section we present Strategic Support Systems, which are systems able to support decision makers at a strategic level.

4

Strategic Decision Support Systems

The origin of the term “strategy” is from the Greek word “**strategos**” which means “general.” It is an imprecise term that has many definitions depending on the perspective (Carey, 1989; Hax and Majluf, 1984; Scott Morton, 1986). For a long time, researchers often used different terminologies such as strategic planning (Wehrich, 1982), strategic management (Schendel and Hofer, 1979), and strategic formulation (Andrews, 1980; Belardo *et al.*, 1994). The differences between all these terminologies are summarized in Table 4.1.

DSS stands for Decision Support System. It is defined as “an interactive, flexible and adaptable Computer Based Information System which uses decision rules, models and model base as well as a database. The decision makers apply decisions in solving problems which would not be willing to manage visualization models perse” (Waxlax, 1993). Another definition considers a DSS as “an interactive and adaptable Computer Based Information System which helps non-organized management problems” (Alyoubi, 2015; Moormann and Lochte-Holtgreven, 1993).

SDSS provide a long-term view of how organization activities will grow and achieve. Without strategic methods, the decision will falter

Table 4.1: Strategic decision support systems terminologies

	Strategic planning	Strategic management	Strategic formulation
Description	Is a process which tends to define the organizational vision of the future, determine their goals and used to set priorities.	Is the process to achieve organizational goals, objectives to make an organization more competitive.	Is the process of selection of the best action to meet the organization objectives and visions but it is one of the steps of strategic management.
Function	Identifying actions and procedures to be taken.	Identifying actions and procedures to be taken.	Identifying actions and procedures to be taken.
Process	Analytical process	Action oriented process	Analytical process

to meet goals at any given time. The literature on SDSS is large and varies on the functionality of SDSS. According to Belardo *et al.* (1994) strategy has also been viewed as consisting of three processes: strategic planning, strategic thinking, and opportunistic decision making.

In addition, Belardo *et al.* (1994) defined the SDSS as menu-driven and consisting of three major sections: Tools, Tutorial, and Application. Furthermore, Moormann and Lochte-Holtgreven (1993), across their approach to SDSS features, state that SDSS:

- Have one or more specific DSS,
- Concern types of problems that are strategic in nature,
- Concentrate on the “information” and the “design” (Simon, 1960) phases rather than the evaluation step,
- Integrate all relevant data resources and planning techniques, and
- Cover both the conceptual planning process and the corresponding tools including the software configuration.

Table 4.2: Existing strategic actions included in DSS (Kitsios and Kamariotou, 2018a)

Strategic actions included in DSS	References
Identification of environmental trends, internal trends and performance trends Planning responses to the issues Assessing the impact and urgency of the issues, and prioritizing the issues	(Korpela and Tuominen, 1996)
Evaluation Culture analysis Environment analysis SWOT analysis	(Moormann and Lochte-Holtgreven, 1993)
Strategy operating subsystem Goal-setting subsystem Environmental analysis subsystem	(Yoo and Digman, 1987)

The combination of strategic actions with DSS is a promising research area. However, most surveys neglect the strategic DSS and only consider the technical aspect of DSS. SDSS have been implemented and utilized by companies and organizations in a variety of industries such as supply chain and logistics (Kitsios and Kamariotou, 2018a), and the agrifood industry (Hajimirzajana *et al.*, 2021). Kitsios and Kamariotou (2018a) proposes a strategic DSS framework which combines both the strategic management process and the Strategic Information Systems Planning (SISP) process to achieve effective decision making in logistics. Regarding Kitsios and Kamariotou (2018a), the existing strategic actions included in DSS are summarized in Table 4.2.

On the other hand, previous research deals with the benefits of Strategic DSS in logistics such as transport (Fanti *et al.*, 2015), warehouse (Naseem *et al.*, 2017), and supply chains (Accorsi *et al.*, 2014). Fanti *et al.* (2015) developed a Strategic DSS for the operation and tactical levels by using sea transport as a case study. Another area of logistics where strategic DSS are used is to handle storage systems based on the estimation of parameters, such as costs for racks and storage equipment (Accorsi *et al.*, 2014).

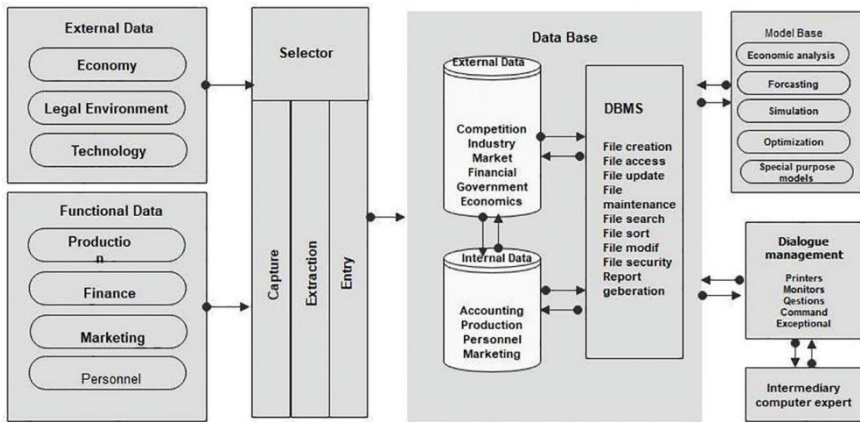

Figure 4.1: Integrated strategic decision support system (Mohsen, 1988).

Mohsen (1988) proposes a typical integrated SDSS comprising various key components: a selector database, a Database Management System (DBMS), a model base, a dialogue interface, and user interactions. The primary role of the selector component within this framework is to sift through information relevant to the significant operational domains of the business (see Figure 4.1).

This screening procedure is designed to align with the critical success factors, ensuring that only the most pertinent data is accepted into the database. The screening process can manifest in both manual and automated forms. This implies that the organization may employ predefined forms to input data, establishing a structured approach. Additionally, there's the possibility of involving human validation to oversee the data entry or the collected information.

- **Model base management systems (MBMS):** The model base necessitates a compilation of routines and models that enable the execution of the subsequent functions: forecasting, optimization, simulation, special purpose models, and econometric analysis.
- **Database management systems (DBMS):** A commercially accessible software package, the database management system (DBMS), undertakes a multitude of tasks by utilizing DBMS, users

of the DSS can conduct various operations on the data within the DSSs database component.

- **Internal data:** Personnel, marketing, production, accounting, etc.
- **External data:** Government, economic, industry, competition, market, etc.
- **Dialogue:** The dialogue component needs to encompass diverse varieties of hardware and software interfaces: printers and plotters, graphic terminals, software interfaces, etc.
- **Users:** The final element of a Decision Support System (**DSS**) is the user. The potential user encompasses any individual involved in making decisions and who is intrigued by the prospect of utilizing a DSS. At times, these users may have a keen interest in constructing intricate computational models.

The crux of an optimal strategic decision-making process involves the availability of timely and cohesive information that can be easily accessed by the relevant decision-makers. Table 4.3 outlines the information prerequisites for effective strategic decision-making and Table 4.4 summarizes the major functional areas and strategic decisions within each area.

Table 4.3: Strategic decisions within each functional area (Mohsen, 1988)

Marketing	Production	Finance	Personnel
Product range	Plant size and share	Assets and their structural components	Labour force: size and skill
Product quality Product profitability	Equipment type and age	Cash flow Profitability	Industrial relations Manpower training and development
Sales and service organization	Supply sources for equipment and materials		
Market size and share	Output design Innovative capabilities	Sources and uses of funds	Organization structure Management

Table 4.4: Information requirements for strategic decision making (Mohsen, 1988)

Information attributes	Strategic decisions
Source	Mostly external
Accuracy	Not that important
Format or mode presentation	Summary and mostly graphics
Frequency	Periodic and exceptionnal reporting
Time horizon	Medium and mostly long range
Utilization purpose	Forecasting and planning
Users	Mostly top management

Shuliang *et al.* (2011) specified that to generate proficient and impactful assistance for formulating digital marketing strategies, a web enabled hybrid knowledge automation decision support system should:

- Facilitate decision makers in accessing expertise, guidelines, and analytical models for digital marketing planning seamlessly, regardless of time zones or geographical locations, through a globally accessible internet platform.
- Automate intelligent reasoning and real time advisory processes using a web-based intelligent system.
- Harmonize the strengths and advantages of different decision support methods and artificial intelligence technologies.

This proposed prototype is considered as a strategic planning one.

Jim and Lee (2002) proposed a Web-based system architecture for multi-participant Cognitive Decision Support Systems (**CDSS**) for strategic decision-making. The discussed prototype system diverges from the conventional design focus of current decision support systems. Instead of focusing on the executive’s information needs regarding “critical success factors” and providing specific decision support, this research places emphasis on supporting the executives’ thinking process. The prototype system, comprising three modes, underwent testing in a two-phase case study involving six small business executives.

Agostino *et al.* (2020) introduces the concepts associated with the establishment of a Strategic Engineering approach aimed at bolstering decision-making processes within industrial plants and productive facilities. This obviously presents a strategic advantage for organizations

capable of obtaining a comprehensive understanding of the situation by gathering data and transforming them into actionable information. This information is instrumental in supporting day-to-day operations as well as making high-level strategic decisions. It underscores the significant role of Industry 4.0 as a potent facilitator. Consequently, the synergistic integration of Simulation, Artificial Intelligence (AI), and Data Analytics is identified as a potential multiplier effect. However, to harness its full potential, careful design of the associated architecture and models is imperative. The prototype system, consisting of three modes, underwent testing through a two-phase case study involving six small business executives. The results yield preliminary evidence suggesting that with further development, the system could serve as a valuable cognitive support tool.

In the next section, we provide a history of the use of SDSS architecture in chronological order of the suggested models in several research fields.

5

SDSSs Architectures and Models

The aim of this section is to position the current strategic models to the existing surveys on DSS and to identify specific research questions to be asked about them. Furthermore, we provide an overview of the different SDSS models.

Strategic Management Models

A strategic management model is a framework or approach used to guide an organization to achieve its long-term goals by adopting a systematic way of formulating, implementing, evaluating and controlling the implemented strategy. There are different models of strategic management that are established by several authors mentioned below.

Yoo and Digman (1987) proposed a DSS model for strategic management that was widely used and adopted thereafter. It includes 4 subsystems: Environmental Analysis Subsystem, Goal-setting Subsystem, Decision Support Subsystem and Strategy Operating Subsystem (see Figure 5.1).

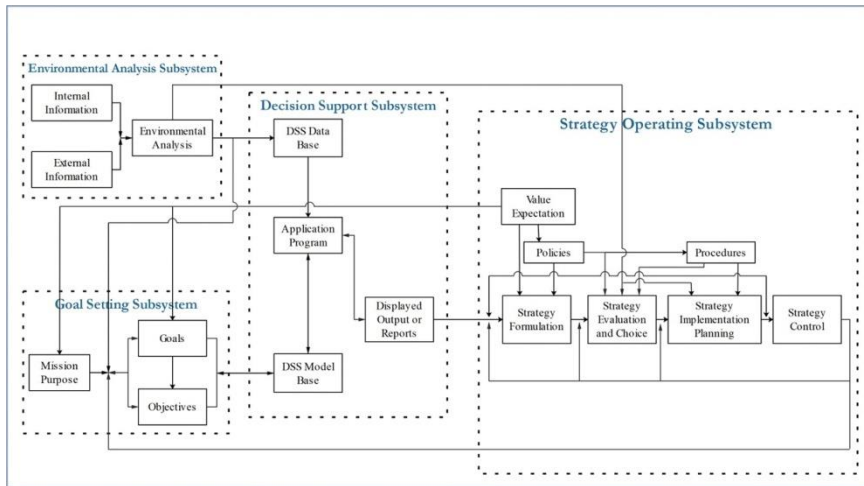

Figure 5.1: DSS for strategic management (Yoo and Digman, 1987).

In the Environmental Analysis Subsystem, internal and external information that reflect and project the business environment are gathered. This task is carried out by the staff, customers, consultants, and managers.

The Goal Setting Subsystem includes a model base to generate alternative scenarios. The aim of this subsystem is to choose one or more suitable alternatives according to the objectives and mission of the organization. The resulting choice could be fed as input to the strategy operating subsystem.

The Decision Support Subsystem is composed of a database that contains and manages different kinds of information from various sources and transactions, a model base which helps with the solution of strategic problems and generates information about the problem to be evaluated by managers and developed in the next subsystem. Various mathematical models (intelligent analysis methods, fuzzy set theory. . .) are deployed at this stage to help generate alternative solutions, evaluating them and choosing the best ones. Finally, the application program contains a set of menus and dialogues to support the latter process.

The fourth and last subsystem supports each phase of the strategic management process. It assists decision makers in formulating, assessing,

and selecting alternative strategies, then allows them to implement the chosen strategy based on the output of the DSS subsystem.

Table 5.1 presents a summary of the author's views and terminology used when building strategic management models (Yoo and Digman, 1987). As shown in Table 5.1, each model has one or more cons that (Yoo and Digman, 1987) tried to overcome in their proposed strategic model depicted in Figure 5.2. The proposed model is composed of a seven phase process.

- It begins with the definition of the organization's mission and directions "why it exists and competes in a certain sector or industry?"
- The second phase consists of defining the objectives and goals "to what end this organization was built?"
- The third step consists of analyzing the environment for internal (inside the organization) and external (outside the organization) resources to achieve a productive match with the external environment.
- The next step is strategy formulation, in which the internal and external resources are used to build a decision making process by determining strategic options or means to meet organizational goals.
- The evaluation and choice phase consists of choosing the best strategy or alternatives.
- After evaluating and choosing a strategy, begins the process of turning it into real actions in the implementation phase.
- Then in the strategic control phase, the strategy's implementation is evaluated to see whether the desired results are met, if not, then a modification or a change of strategy is required.

Belardo *et al.* (1994) proposed a SDSS for the Banknotes and Securities division of Swiss printing company Orell Füssli. This system is menu-driven and incorporates three sections: Tools, Tutorial and

Table 5.1: Summary of each author's view (Yoo and Digman, 1987)

Authors	Terminology used	Comment about developed model
William F. Glueck	Strategic planning Strategic management (revised model)	Lack of strategic control function. Strategists are being matched with the strategy they have developed and chosen. Omission of the important medium and short range planning activities of strategy implementation.
Kenneth E. Andrews	Strategy formulation	Ignores implementation and control (Model in 1965). Ignores detailed planning aspects of implementation as strategic control or evaluation (Model in 1971).
George A. Steiner	Corporate planning and Strategic planning	Includes the plan to plan step Divides planning process into strategic and tactical planning. Incorporates an implementation step and a quasi control function dealing with the review and evaluation of plan (but not an explicit review of the strategy).
A. A. Thompson Jr. and A. J. Strickland, III	Strategic management	The mission or purpose more correctly defines why the organization exists, and thus should be separated from objectives more definitely. Defines the term policy too narrowly.
Dan E. Schendel and Charles W. Hofer	Strategic management	While their model explicitly includes environmental analysis, the important resource and value analysis factor are not specifically shown.

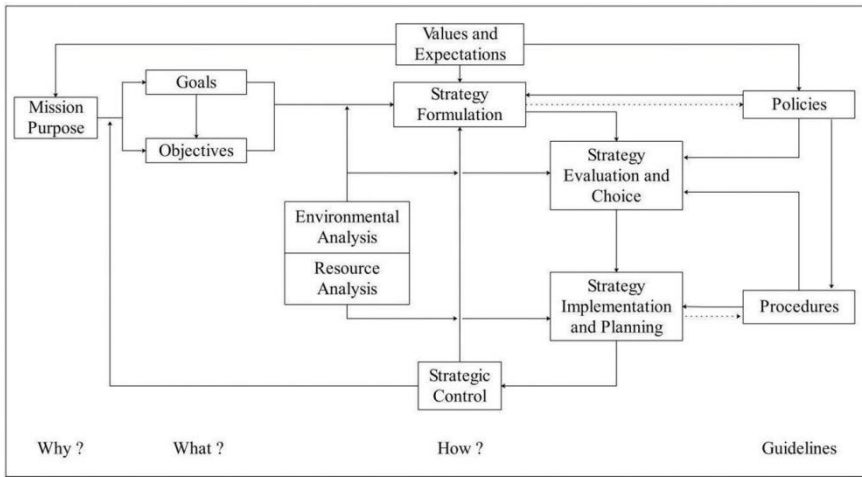

Figure 5.2: Integrated model of strategic management and policy (Yoo and Digman, 1987).

Application. The tools consist of conceptual models and methods used in strategy and information management such as product portfolio matrix, value chain model, SPACE method, etc. The tutorial section is about real cases used to demonstrate the use of conceptual models to managers. Three cases were implemented: banknotes, securities, and plastic cards.

Finally, the application section, which is the interactive part of the system that needs user intervention, consists of a process of two parts and six steps total, each part containing three steps and exploits both the tool's models and tutorial's cases.

The first stage assists managers to define improvement of products and new opportunities to seek, it is composed of three steps: strategic market position, market objectives, strategic thinking using intrinsic value task analysis.

The second stage helps managers in the implementation procedure of the new market strategies from the previous stage, it is composed of three steps; strategy evaluation with multifactor portfolio matrix (**MPM**); sensitivity analysis; and strategy evaluation with SPACE method.

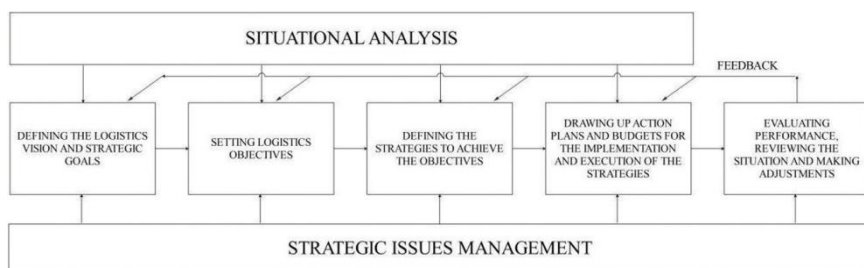

Figure 5.3: Strategic issues management (Korpela and Tuominen, 1996).

Korpela and Tuominen (1996) proposed a decision support system for strategic issues management of logistics activities. It is integrated into a flexible and continuous strategic issues management process presented in Figure 5.3.

The proposed DSS is based on a multicriteria method AHP (Analytic Hierarchy Process) (Saaty, 1990) where the idea is to consider the issues at hand as a complex multi criteria problem, and use the AHP method to determine the priorities of the decision alternatives.

The role of the AHP method is illustrated in Figure 5.4. It is used to support managers in identifying and analyzing emerging trends and issues, estimating the impact and urgency of the issues, and planning the required actions for strategic issues.

Khalfan (2014) developed and implemented a strategic management model tailored to the unique needs and goals of academic libraries to enhance their effectiveness and relevance in supporting the academic community. This work provides a framework for academic libraries to navigate challenges, capitalize on opportunities, and achieve their long-term objectives in serving the needs of their users and advancing the academic mission of their institutions.

The proposed model depicted in Figure 5.5 is tailored specifically for academic libraries, integrating additional aspects while remaining congruent with the three core stages of strategy formulation, implementation, and evaluation/control. These stages are synthesized into three distinct phases: the pre-planning stage, planning stage, and post-planning stage. Successfully addressing the elements within each stage is crucial for the organization to realize its goals and fulfil its vision:

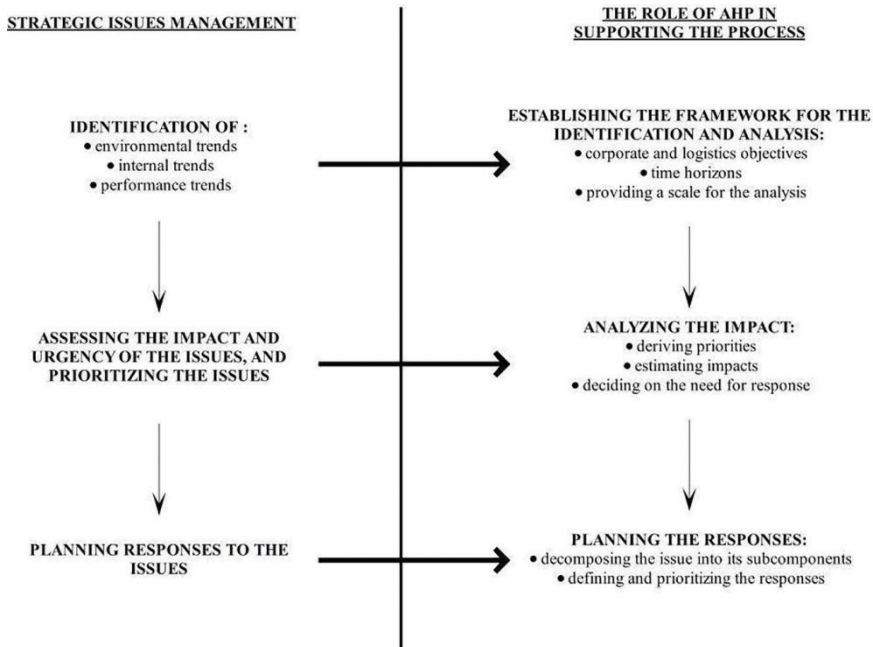

Figure 5.4: Role of AHP in the logistics strategic issue management process (Saaty, 1990).

- **Strategy Formulation:** this initial phase centres on delineating the organization’s mission, vision, and goals. It culminates in the selection of an appropriate strategy tailored to achieving these objectives.
- **Strategy Implementations:** the subsequent phase entails translating formulated strategies into action. It encompasses decision regarding leadership, organizational structure, and resource allocation, ensuring the provision of necessary resource for execution.
- **Strategy Evaluation and Control:** in the final phase, the focus shifts to assessing performance and maintaining strategic alignment. This involves adopting measurement tools to evaluate organizational performance, enabling informed decision-making and corrective action as necessary.

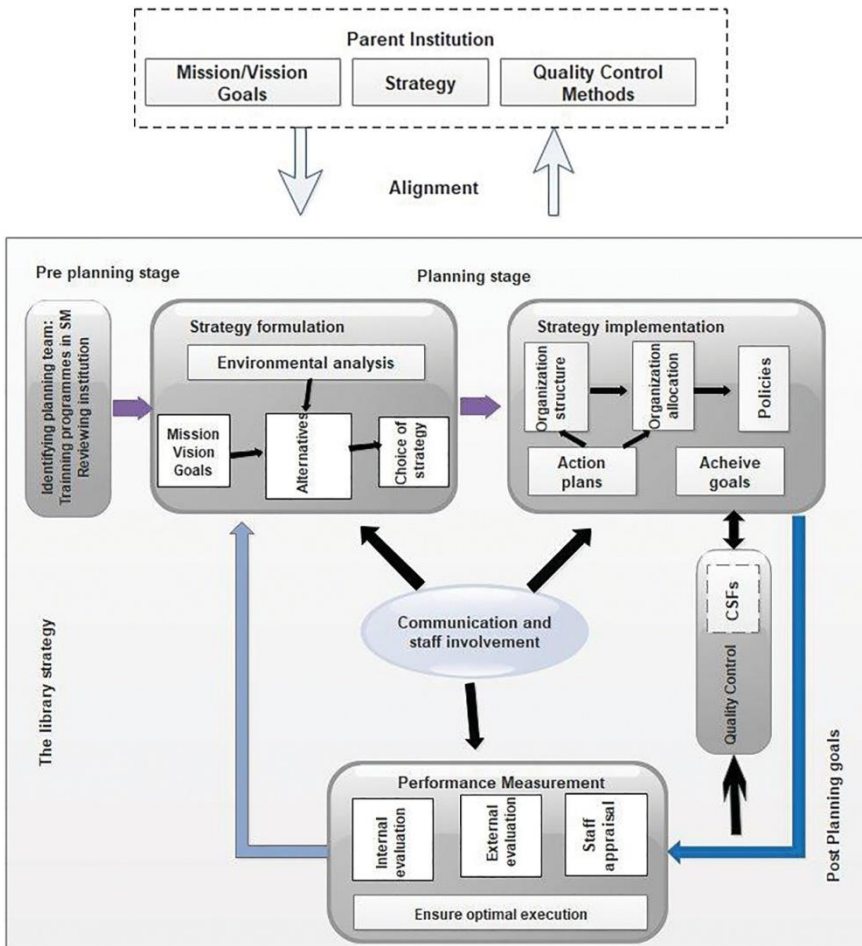

Figure 5.5: Strategic management architecture for academic libraries (Khalfan, 2014).

Jim and Lee (2002) report the design, development, and exploratory assessment of a prototype Cognitive Decision Support System (CDSS) for strategic management decision making (see Figure 5.6). The architecture is composed of the following components: CDSS Graphic User Interface, Problem Processing System (Case Memory Subsystem,

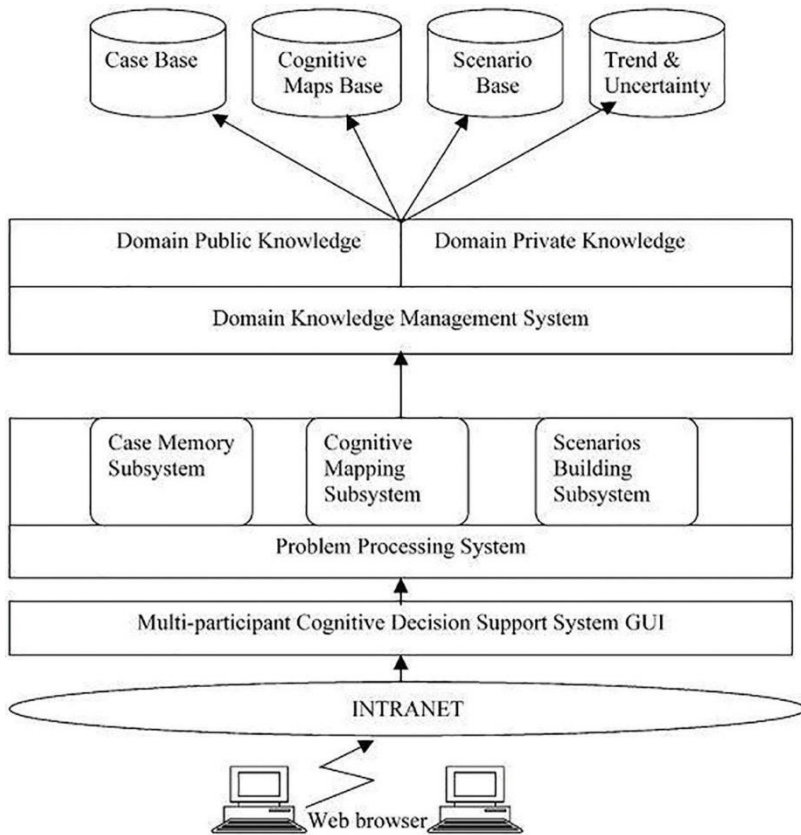

Figure 5.6: Cognitive decision support systems (CDSS) for strategic decision-making (Jim and Lee, 2002).

Cognitive Mapping Subsystem, and Scenario Builder), Knowledge Management System (Case Base, Cognitive Map Base, Scenario Base, and Trends and Uncertainties):

Graphic User Interface: the CDSS is designed to operate within an organization’s Intranet environment. Users can access the system via standard web browsers connecting to the application server. The system offers a comprehensive graphical user interface to facilitate user interaction.

Problem Processing System: the PPS comprises three modules: Case Memory, Cognitive Mapping, and Scenario Building. When a

user logs on to the CDSS, a process begins, and a portion of working memory is assigned to the user. Knowledge acquisition and selection occur through user interactions with the three modules. Information is processed within working memory and then transferred to the knowledge management system for storage. The system's knowledge, such as procedures for creating cognitive maps and scenarios, is hardcoded into the PPS:

Case Memory Subsystem: the Case Memory Subsystem is designed to offer users a suite of tools for documenting and accessing business cases, as well as various forms of “soft” information like rumours, speculations, and personal experiences. Users have the flexibility to designate their cases as private or public, with public cases accessible to all members of a decision-making team.

Cognitive Mapping Subsystem: the purpose of this subsystem is to equip the decision maker with a range of tools to build, adjust, and inquire about their own causal reasoning regarding a specific issue. It facilitates the comparison of one's own causal map with that of another individual on the same issue.

Scenario Builder: this subsystem aids users in creating and accessing business scenarios. It leverages knowledge from the Trends and Uncertainties knowledge base to engage with the user and identify economic, political, societal, technological, and industry trends, along with key uncertainties. The system elicits and stores the user's insights and opinions in the knowledge base.

Domain Knowledge Management System: the domain knowledge management system offers users tools for managing and manipulating domain knowledge, which includes cases, cognitive maps, and scenarios. Domain knowledge is categorized into private and public knowledge. Private knowledge is accessible only to specific users. This division is crucial in a multi-participant CDSS as decision-makers require time to deliberate on their cases, cognitive maps, and scenarios before sharing them publicly. Both private and public knowledge are stored in the Case Base, Cognitive Map Base, and Scenario Base.

The prototype system discussed in this research (Jim and Lee, 2002) deviates from the conventional design focus, which typically centres on the executive's information needs regarding “critical success

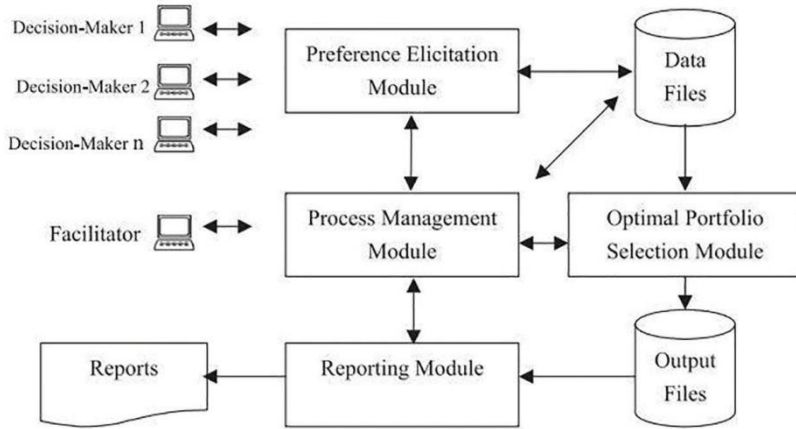

Figure 5.7: Strategic portfolio management architecture (Chinho and Hsieh, 2003).

factors” and the requirement for specific decision support. Instead, this research underscores the importance of supporting the executives’ thinking process.

Chinho and Hsieh (2003) devised an integrated framework merging fuzzy theory with strategic portfolio selection. This framework offers managers a dynamic, adaptable, and interactive DSS for project selection in portfolio management. The approach for project portfolio comprises three main phases: Pre-evaluation, Preference elicitation, and data analysis and reporting (see Figure 5.7).

The Pre-evaluation phase involves key activities:

- Identifying and selecting the alternance for evaluation.
- Establishing strategic focus and resource constraints.
- Determining the portfolio matrix and associated evaluation criteria (see Figure 5.8).
- Specifying the type of fuzzy integer linear programming model and assigning relative importance to coefficients.

One widely used portfolio matrix is the GE Multifactor Portfolio Matrix, developed collaboratively by General Electric and McKinsey & Company (Refer to Figure 5.8). This tool assists managers in comprehending the

		Industry Attractiveness		
		High	Medium	Low
Business Strength	High	Investment and growth	Selective growth	Selectivity
	Medium	Selection growth	Selectivity	Harvest/Divest
	Low	Selectivity	Harvest/Divest	Harvest / Divest

Figure 5.8: Industry attractiveness vs. business strength matrix (Chinho and Hsieh, 2003).

competitive positioning of Strategic Business Units (UBUs), primarily based on Industry Attractiveness (IA) and Business Strength (BS).

Industry attractiveness is evaluated subjectively, considering external factors beyond the firm’s control. Conversely, business strength is assessed based on critical success factors, predominantly within the firm’s control. Each dimension comprises a blend of various factors. For instance, industry attractiveness may be determined by factors such as industry competition levels and growth rates, while business strength may be influenced by factors like financial stability and bargaining power with suppliers. The preference elicitation phase comprises two main activities:

- Collecting individual confidence and defining linguistic variable along with their corresponding triangular fuzzy numbers.
- Determining the scores for weighting the criteria and rating the alternatives.

The first activity serves as the foundational step for leveraging fuzzy set theory to address linguistic uncertainty and accommodate varying confidence levels among decision-makers. The third phase, known as the calculation process, encompasses data analysis and reporting. This phase utilizes two algorithms: The fuzzy weighted average, employed to

ascertain the competitive advantage of Strategic Business Units (SBUs) and assess the feasibility of strategic plans; and the fuzzy integer linear programming algorithm, utilized for selecting the optimal strategic plans.

Strategic Planning Models

This section gives an overview of the strategic planning process to improve operations, deliver quality, and meet specific goals in an organization. What follows are some studies of strategic planning models that expand on these goals.

Zviran (1990) proposed an interactive decision support system for strategic planning of information systems called ISSPSS (Information Systems Strategic Planning Support System). It facilitates the execution of critical strategic planning operations by IS managers. This system is considered as a model-oriented Suggestion DSS (Alter, 1980). Using empirically based formulas and decision criteria, it provides recommended directions for an IS Strategic Plan (ISSP), documents the process, and produces a draft of an IS Strategic Plan. The main component of ISSP is the model base, which consists of three modules that each address a certain aspect of the IS Strategic Planning process. These components and the strategic issue they resolve are illustrated in Figure 5.9.

The first module uses a strategic grid (Cash *et al.*, 1992; Lederer and Sethi, 1988) to evaluate the importance and role of the organizational information system. The second module is an objective using organizational objectives and Critical Success Factors (CSF). The third and last module proposes an architecture (centralized, distributed).

Finlay and Marples (1992) discussed a previous contribution made by Jessup and Kukalis (1990) in which they highlighted the benefits of using and migrating to Group decision support systems to support strategic planning. They reported the experiences of managers of the Burr-Brown Corporation and those of IBM. Eden (1985) discusses some flows in the latter paper and proposes a new methodology SODA (Strategic Options and Development Analysis) to support managers solving group decision making for strategic planning. In Figure 5.10, an application of the SODA methodology is given. This application was

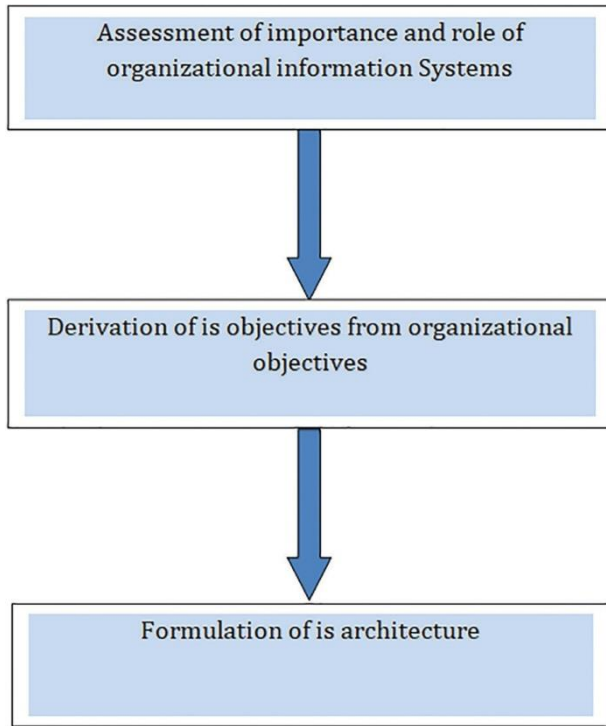

Figure 5.9: Planning activities supported by ISSPSS (Alter, 1980).

carried out by Eden (1985). Up to 40 publishing teams were involved in the process, and the aim was to get a strategic change to one of its publications.

The activities proceed as follows: First, the facilitator and senior manager and analyst meet to discuss the structure of planning activities, the participants in the sessions, and the way the sessions would be performed. Then, the facilitator interviews each of the participants to refine their cognitive map in the next step. After that, a second round of interviews is carried out for some participants to further improve their cognitive map. Next, the facilitator produces the strategic map based on the common concepts and ideas from the analysis of individual maps of the previous step. The final step is the action workshop in which the group of involved participants would meet to discuss and decide on the strategic map developed in the previous step.

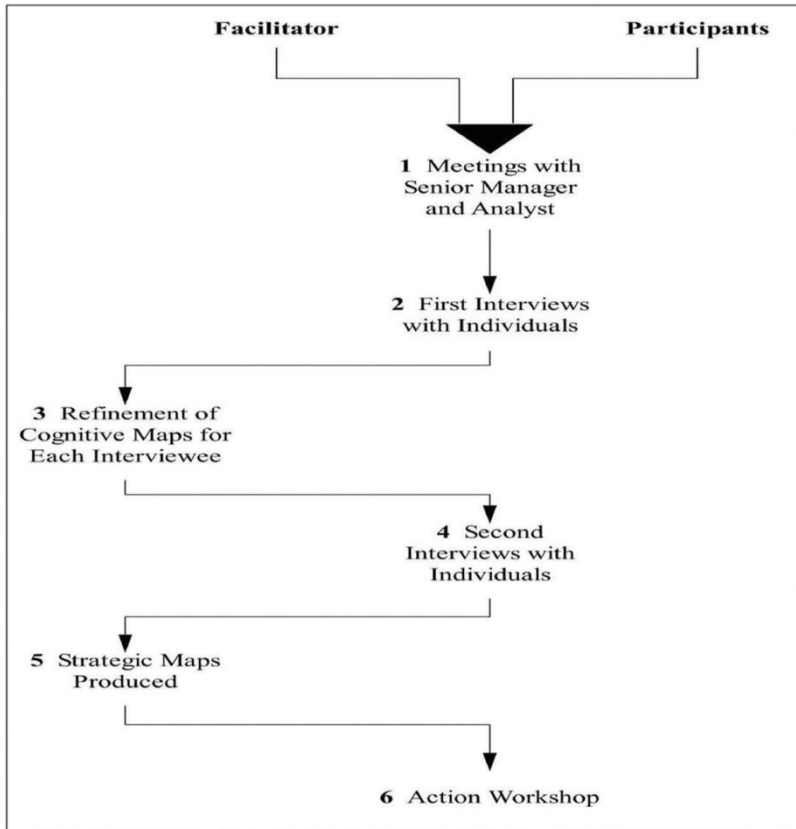

Figure 5.10: Application of the SODA methodology (Eden, 1985).

In addition, Moormann and Lochte-Holtgreven (1993) proposed a prototype of an integrated DSS for strategic planning called StratConsult. The main idea of this prototype is to provide a menu-driven user interface that aids managers to conduct strategic planning activities using qualitative and quantitative methods to cover all the phases of the strategic planning process. Figure 5.11 depicts the system's components, the main menu covers three phases: Information, Design and Evaluation. Also, the strategic tools supported by StraConsult are highlighted in Table 5.2.

Other work on strategic planning (Hornby *et al.*, 1994) examines a strategic planning support tool Called SDP (School Development

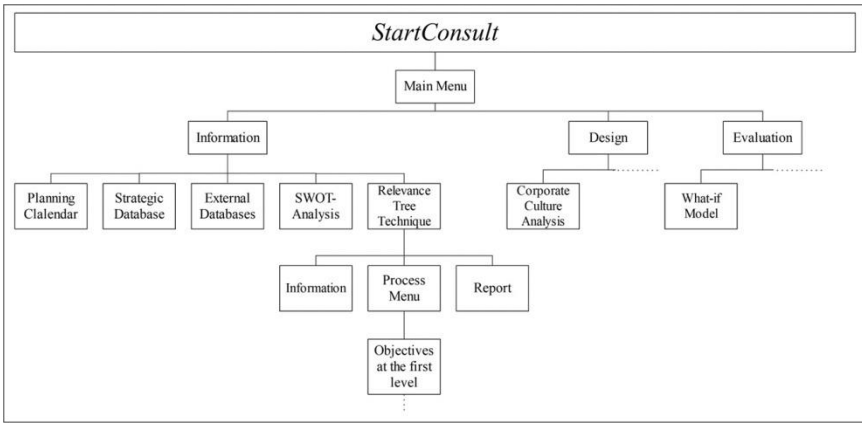

Figure 5.11: Structure of StratConsult (Moormann and Lochte-Holtgreven, 1993).

Table 5.2: Instruments implemented in StratConsult (Moormann and Lochte-Holtgreven, 1993)

Instruments implemented in StatConsult
<i>Information phase</i>
Work programs and planning calendar
Internal strategic database
Access to external online databases
SWOT analysis
Relevance tree technique
<i>Design phase</i>
Corporate culture analysis
Morphological method
Cross impact analysis
Portfolio analysis strategic business unit graph
<i>Evaluation phase</i>
What-if model
Decision tree technique

Planner) developed for school managers. SDP was proposed by Morgan Barnett Associates to help and support senior managers in planning the future development of their schools (Hornby *et al.*, 1994). In this work, the software version of the SDP was initially used as a training

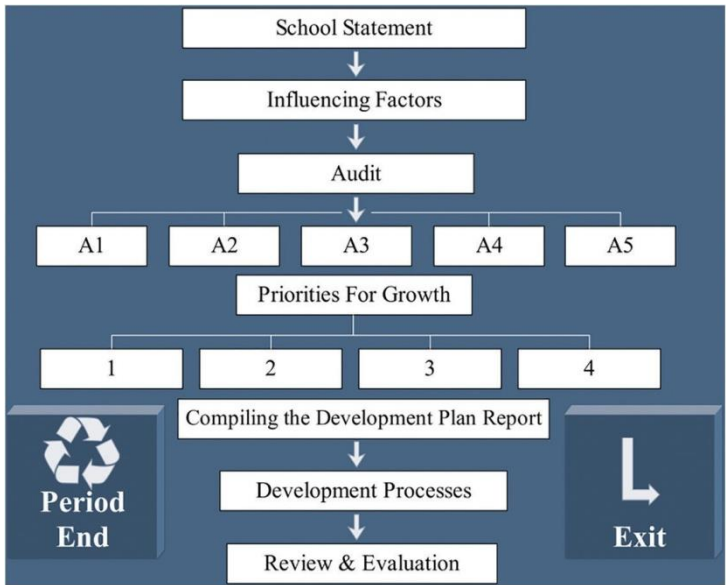

Figure 5.12: Main screen of SDP (Hornby *et al.*, 1994).

tool. It uses an interactive user interface to control and illustrate the planning process (see Figure 5.12).

The process adopted is as follows:

- **The school statement:** school managers introduce a clear, simple, and practical statement of their school’s general objectives and mission.
- **Influencing factors,** which consists of a three-stage process starting with collecting background information grouped into “reviews”, “initiatives”, “views” and “other”. Then a discussion is triggered to consolidate the available information. And finally, the refinement stage where the aim is to present short, medium and long term problems.
- **Audit:** this part allows a full inspection of the basic resources of the school to construct the current resource position.

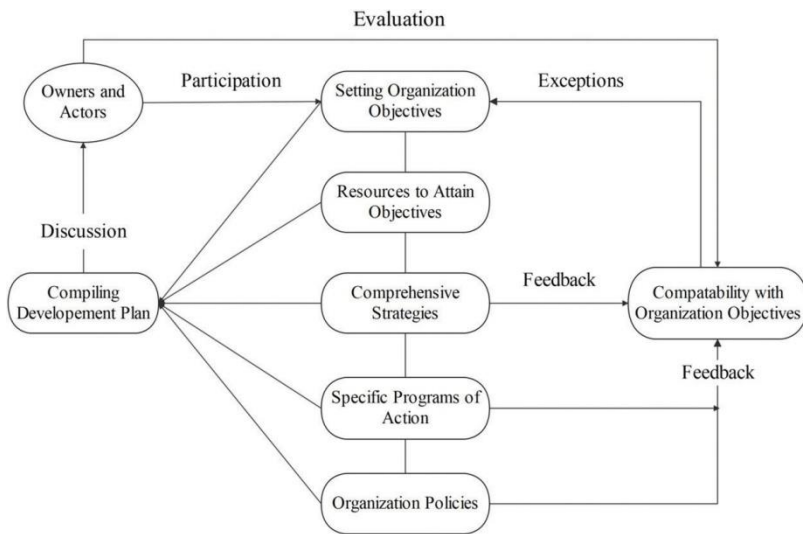

Figure 5.13: Revised strategic planning model (Thierauf, 1988).

- **Priorities for growth:** once the desirable amount of audit is finished; the managers might define up to four particular development goals or priorities. Once specified, these priorities replace the numbers 1 through 4 on the main control screen.
- **Compiling the development plan:** which is a structured report of the previous stages. Usually, the plan of development should be approved by governors before implementation.

The authors extend the model of Thierauf (1988) (see Figure 5.13) due to the known significance of the communication process in strategic planning. Zviran (1990) proposed the same extension in his ISSPSS system, the difference is that he has a passive step whereas this model supports a more iterative approach.

Development processes: this step allows planning the implementation of the selected priorities.

Evaluation: this stage consists of an overall evaluation of the development plan report implementation of priorities.

Lee *et al.* (2002) proposed a Target-Costing Based Strategic Decision Support System which was designed based on a specific competitive

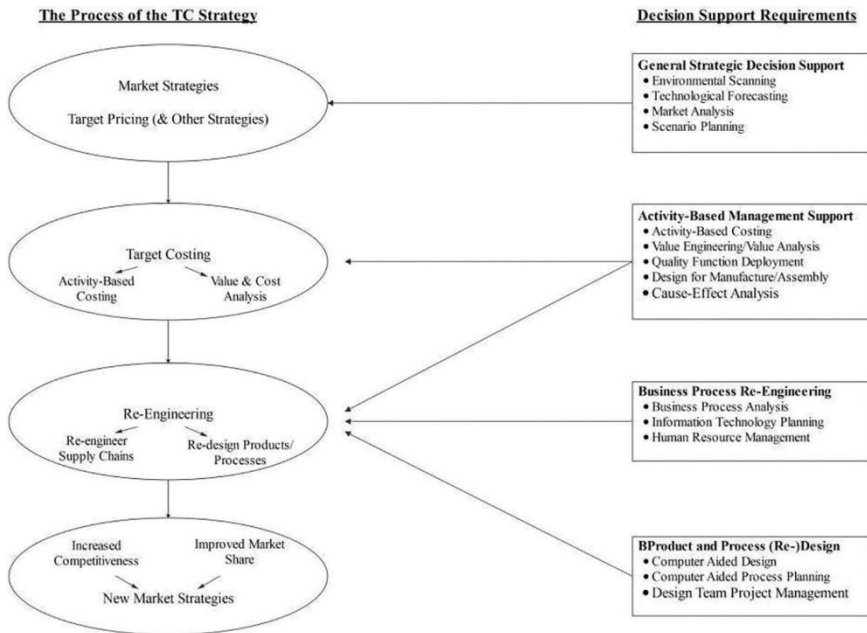

Figure 5.14: Decisional requirements for the target-costing approach (Cooper and Kaplan, 1999).

strategy (Target-Costing) rather than buying general as the majority of SDSS before.

Cooper and Kaplan (1999) describe the Target-Costing approach as a simple logical procedure: *Allow the market to set the pricing of the future product*, Subtract from this selling price the profit margin the company wants to achieve and finally this determines the desired manufacturing cost for the product.

Figure 5.14 illustrates the decisional requirements for the Target-Costing approach. The left side depicts the process of Target Costing, from defining market strategies (e.g.; Target Pricing) to values and cost analysis and reengineering and refinement phase and finally to setting new market strategies. The right side presents the decision support requirements for each of the Target Costing process activities.

The first group of requirements concerns general strategic decision support activities, which are crucial to the organization's general strategic planning process. The second set concerns the firm's Activity-Based Management System whose main aim is the analysis of activities and costs and their relationships. The third group is about Business Process Re-engineering tasks and the final group refers to the Product and Process Design activities.

These requirements are integrated into the Knowledge Subsystem (KS) of the TC-Based SDSS based on the framework proposed by Chung *et al.* (1989). As shown in Figure 5.15, the TC-Based SDSS is composed of four subsystems having each one or several programs to support strategic decision making. The subsystems are as follows:

- User Interface Subsystem (**UIS**),
- Problem Processing Subsystems (**PPS**),
- Knowledge Subsystem (**KS**),
- Subsystem Interface Management Software (**SIMS**).

Min (2009) proposed a decision support system for strategic warehousing. This Warehousing Decision Support System (WDSS) was tested and validated within the Buckeye Cable Vision Incorporated (BCV) firm for their strategic warehouse expansion and re-warehousing decisions. The WDSS was integrated into a DSS framework proposed by Sprague and Carlson (1982) as shown in Figure 5.16. It comprises three major components (subsystems):

The database management subsystem which facilitates the storage and management of internal data (company's annual reports, inventory figures, sales figures, projected revenues, customer lists), external data (public files such as published literature, websites, and CD-ROMs), and other data categories (cost data and warehousing data) created by the authors to enhance the system's performance.

The second subsystem is the Model Management subsystem that constitutes the main core of the WDSS. In this subsystem, computer simulation and mathematical models are created to generate layout options, arrangements of warehousing facilities in a cost-efficient manner,

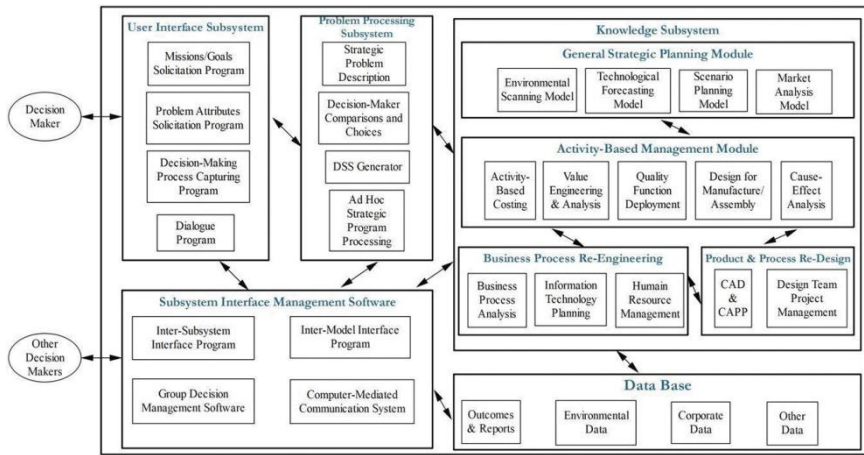

Figure 5.15: Knowledge subsystem (KS) of the TC-based SDSS based on the framework (Chung *et al.*, 1989).

etc. And finally, a Dialogue base that considers any changes in warehouse position, layout, size, budget, and inventory control system, by using a “what-if” analysis.

The authors stated that any small and medium sized companies could use the WDSS for warehousing strategic decision aid. Through the case study in this work, the proposed WDSS could improve both warehousing productivity and supply chain visibility.

Alyoubi (2015) discussed the importance and impact of combining Knowledge Management (KM), Decision Support Systems (DSS) and Strategic Management or planning (SM). The author began with the introduction of different types of decisions as introduced by Gorry and Morton (1989) (see Table 5.3). After that, he explored the DSS model given by Courtney (2001) and illustrated in Figure 5.17.

The process concentrates on the model’s development and problem analysis. It begins with problem recognition then mathematical models are built to deal with the problem at hand and generate solutions which are analyzed and evaluated to choose the appropriate alternative and implemented following the model of Simon (1960). Then, he further presented the notion of Group DSS where the decision implicates a group of executives.

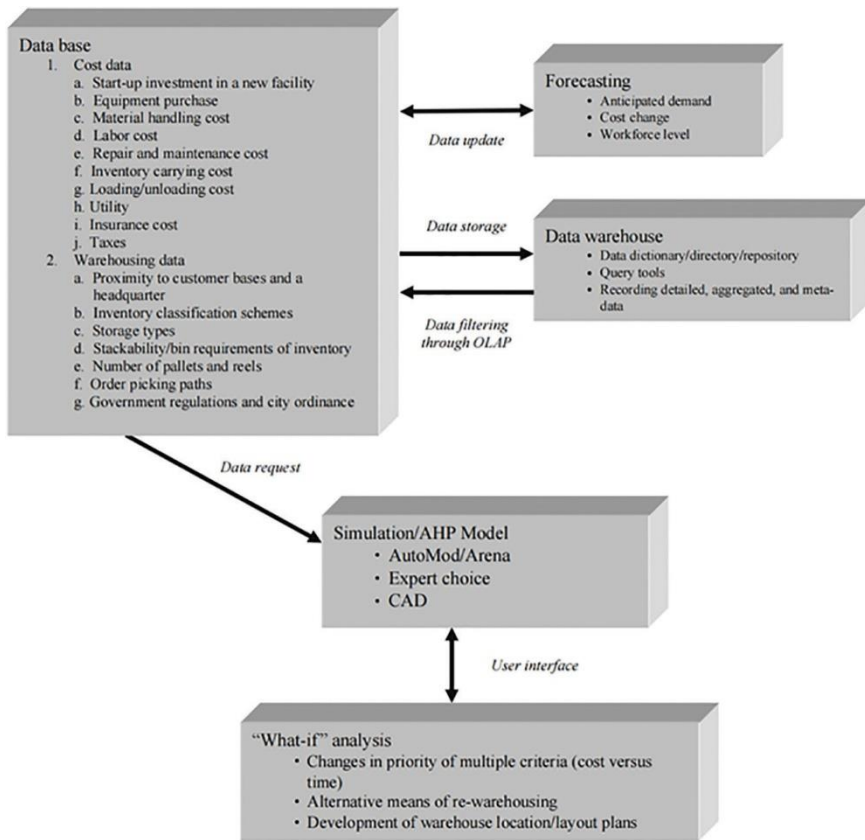

Figure 5.16: WDSS subsystems (Sprague and Carlson, 1982).

Knowledge management is defined in this survey as “the process of capturing tacit knowledge and converting it into explicit knowledge” where tacit knowledge is a set of a person’s ideas and beliefs, viewpoints etc. Explicit knowledge is formal knowledge that may be stated using words, symbols, or rules, among other things. It is measurable information that can be evaluated using mathematical models (Nonaka and Takeuchi, 1995).

Then we described the process (or cycle) of KM given by Nemati *et al.* (2002) and how DSS could help in this process. As shown in Figure 5.18, the KM cycle is composed of four steps:

Table 5.3: Different types of decisions (Gorry and Morton, 1989)

	Strategic planning	Management control	Operational control
Unstructured	E-commerce	Career paths	Grievances
Semi-structured	Forecasting	Budgeting	Assignments
Structured	Dividends	Purchasing	Billing

- Experiences, skills etc. This activity is often supported using Information Socialisation is the sharing of tacit knowledge, where a group of individuals exchange Technology tools.
- Externalisation or Articulation is the process of converting tacit information to explicit knowledge; it is aided by DSS through brainstorming sessions in which people may convey their formal description of a problem and possible solutions.
- Integration or leveraging is the process of generating new knowledge. AI technologies are frequently employed to aid the process at this level.
- Internalization: converting explicit knowledge to implicit knowledge. DSS can assist by Modifying the knowledge worker's internal

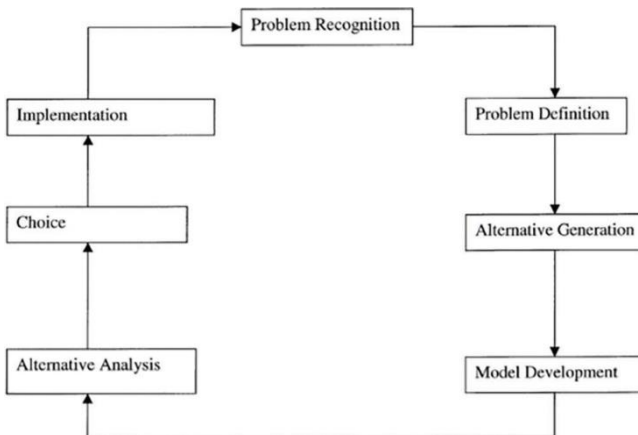

Figure 5.17: DSS model (Courtney, 2001).

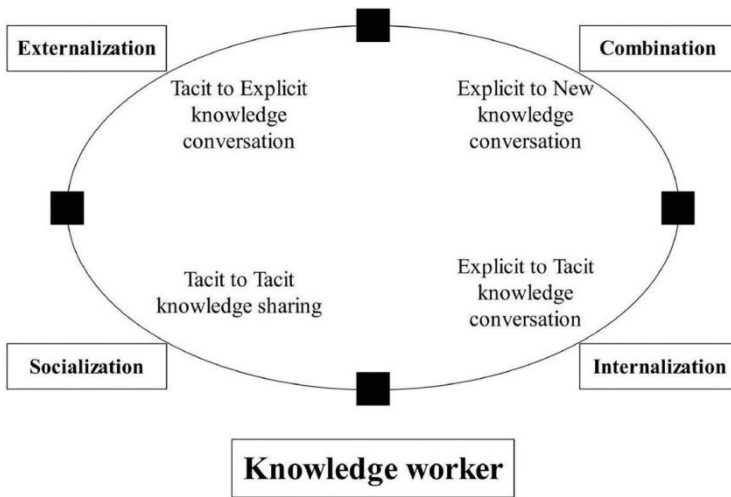

Figure 5.18: The KM cycle (Nemati *et al.*, 2002).

mental model. Knowledge workers frequently utilize these mental models as performance indicators in particular circumstances. DSS can modify this mental model in the appropriate way.

The last section in the study speaks about the significance of KM in strategic planning. According to Huang (2009), knowledge is a crucial asset that can be used to establish and retain a competitive advantage. The complete, cohesive, and integrated plan created to assure the accomplishment of the organization’s goals has frequently been described as a strategy (Jauch and Glueck, 1988). Without the proper information accessible to the strategic planners, this strategy cannot be created. This leads to what is called Strategic Knowledge Acquisition (SKA) which refers to what data the organization needs to collect. Figure 5.19 depicts a diagram representing the role of SKA in boosting the organization’s performance (Pietrzak *et al.*, 2015).

Kitsios and Kamariotou (2018b) investigated the impact of SDSS on Small and Medium firm’s performances. This is unlike the previous works in this area where the investigation relies only on theoretical assumptions and deductions (Newkirk *et al.*, 2003; Lederer and Sethi, 1996). The authors proposed an implementation of a DSS that incorporates the phases of the SISP (Strategic Information Systems Planning) process

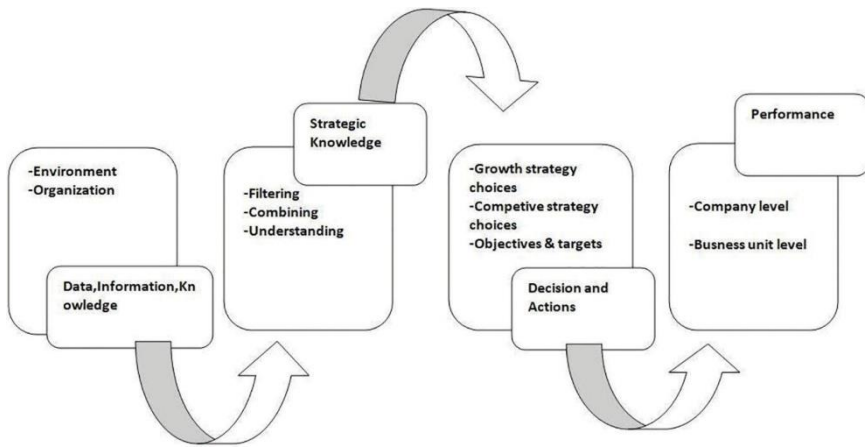

Figure 5.19: A diagram representing the role of SKA in boosting the organization’s performance (Pietrzak *et al.*, 2015).

and investigates how it can increase a company’s profitability. The aim is to determine which of the phases contribute the most and how to further improve them.

The SDSS model adopted in this work was first proposed by Yoo and Digman (1987) and, as mentioned above, it contains four subsystems: Environmental Analysis subsystem, Goal Setting subsystem, Operating subsystem, Decision Support subsystem, and Strategic Information Planning subsystem.

SISP is defined as the capacity to construct a business strategy (Peppard and Ward, 2004). It comprises five phases:

- Strategic Awareness where top level managers and development teams define the key planning challenges and goals.
- Situation Analysis which consists of analyzing the current internal and external resources of the business environment.
- Then, strategy conception. In this phase, the team chooses the most important IS objectives, assesses the chances for improvement, considers different scenarios, and selects the alternatives.
- The fourth phase is Strategy Formulation, in which managers determine the most suitable scenario from the previous alternatives.

- The assessment of this scenario is then carried out considering its strategic and technological implications. Additionally, in this stage, specific new projects and their priority are chosen. These projects also comprise certain tasks that are used to carry out the scenario that has been chosen.
- Finally, the Strategy Implementation Planning phase, which consists of approaching the actions of change management and the evaluation of strategic plans.

Table 5.4 presents a matching between SDSS subsystems and SISP steps along with the relevant activities.

Many issues were encountered during the process concerning manager's communication, cooperation, alignment of company objectives with DSS, and the support of change. The effectiveness of the process and company performance have both been adversely impacted by these factors. Results indicate the relevance and significance of the SISP procedure in enhancing SME profitability. The findings also indicate that the Strategic Awareness and Strategic Implementation stages are not given a great deal of care and priority.

The WebDigital system proposed by Shuliang *et al.* (2011) (see Figure 5.20) consists of several interconnected components: the user interface that is accessible through the web, the database accessible through the web, the Monte Carlo simulation module accessible through the web, the knowledge base accessible through the web, and the inference module accessible through the web.

The primary goals of the WebDigital system include:

- Conducting simulations and evaluations of pertinent factors or variables that influence the process of formulating digital marketing strategies.
- Performing calculations, logical reasoning, and offering guidance on digital marketing strategies.

The Web-based knowledge base: The knowledge base is designed to encapsulate domain expertise for digital marketing strategies, incorporating “IF ... THEN...” statements and fuzzy rules distinguished

Table 5.4: Matching between SDSS subsystems and SISP (Peppard and Ward, 2004)

DSS subsystems	SISP phases	Activities
Environmental analysis subsystem	Strategic awareness	Definition of the problem Determination of key planning issues and objectives Participation of team Management support
Goal determining subsystem	Situation analysis	Analysis of current IS Analysis of current organisational systems Analysis of business environment Analysis of IT environment
Operating subsystem	Strategy conception	Definition of significant IT objectives and objectives for implementation Evaluation of alternatives scenarios
Decision support subsystem	Strategy formulation	Definition of new IT architectures, processes, projects and priorities
Strategic information planning subsystem	Strategy implementation planning	Definition of change management process and action plan Evaluation of the process

by varying degrees of certainty or confidence. It encompasses relevant analytical models, a guide for e-mail marketing, and knowledge about international e-marketing. Fuzzy logic is employed to encode ambiguity, uncertainty, and confidence levels pertaining to factors that influence digital marketing planning.

The Web-enabled user interface: This component facilitates communication and engagement between the decision maker and the WebDigital system. The user initiates the process by providing initial values for triangular probability functions integrated into the Monte Carlo simulation module. Additionally, the system solicits subjective inputs

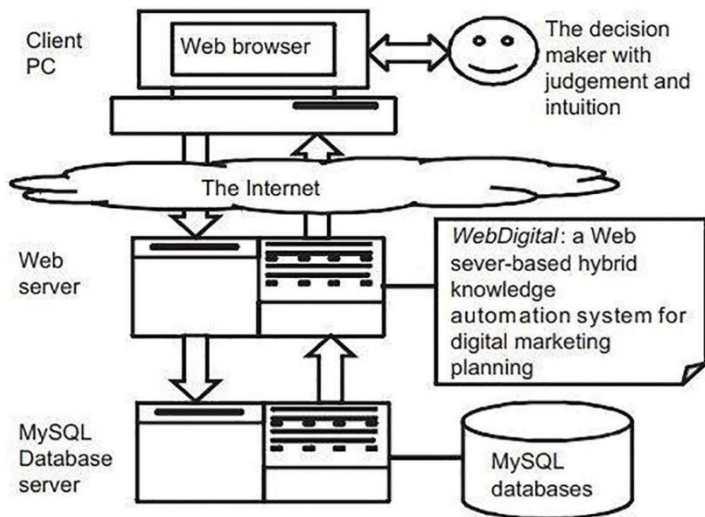

Figure 5.20: The system architecture of the WebDigital system (Shuliang *et al.*, 2011).

concerning various aspects of formulating digital marketing strategies. It subsequently compiles and consolidates these inputs from the user, applies fuzzy logic through membership functions, and employs forward reasoning. The outcome is a generation of informed recommendations encompassing overarching digital marketing strategies, guidelines for e-mail marketing, and strategies for international e-marketing.

The Web-enabled database element: The database component, operating on a web server, is constructed using the MySQL relational database management system. It preserves the outcomes of the online Monte Carlo simulations and manages the storage as well as retrieval of user inputs throughout the planning phase. This element of the database is also responsible for overseeing user account details and the data that underpins the reasoning or chaining processes carried out by the inference control component.

The Web-based inference: The system utilizes a search approach that commences with established facts and endeavours to deduce the logical outcomes that can be inferred from these facts. The chaining mechanism within WebDigital is implemented through the forward

reasoning technique. In this process, the user provided data, along with pre-programmed “**IF . . . THEN**” statements and fuzzy rules within the knowledge bases, are employed in a data oriented forward thinking manner. The system engages in real time reasoning and generates online suggestions or guidance for digital marketing strategies.

The Web-based Monte Carlo simulation element: Monte Carlo simulation proves valuable in modelling and assessing stochastic behaviours. In the context described here, the online Monte Carlo component serves the purpose of exploring the fluctuations and uncertainties connected with variables or factors that impact digital marketing. Triangular probability distributions (Rezaie *et al.*, 2007) are employed to represent pessimistic, most likely, and optimistic values for the pertinent factors. The decision maker is prompted to provide their subjective data for these variables. The system then initiates web-based simulations repeatedly, using independently drawn numbers. The averaged outcomes of these simulations are subsequently uploaded to and stored within web-based MySQL databases.

Xiaodong *et al.* (2016) propose a DSS that has been developed to provide various stakeholders in offshore wind farms with a tool to aid in decision-making for cost-effective maintenance operations. These operations involve selecting maintenance strategies for project developers, determining the annual number of technicians needed for HR managers, and identifying the necessary chartered vessels for O & M planners, all with the goal of minimizing costs.

Deterministic and stochastic optimization models are proposed to optimize personnel, transportation, and breakdown costs of O & M. The deterministic model is applied when the failure rate is known, while the stochastic model is used when failure data is unavailable from operational practices.

The optimization models and solution methods are integrated into the DSS to create an efficient decision-making tool for optimizing and analyzing maintenance activities. This DSS was developed as part of the 20 m (Offshore Operations & Maintenance Mutualisation) project, funded by the EU Interred IVA France (Channel) and England programme.

6

Generative AI for Strategic Decision Support Systems

Generative AI is an emerging technology that commonly employs unsupervised or semi-supervised learning algorithms to empower machines to produce novel content including image, text, audio files, video, code, and other types of data. This technology can be perceived as an advancement in artificial intelligence as it enables machines to innovate and create original outputs by leveraging patterns learned from their training data.

ChatGPT is one of the most promising advances in the field of AI. It generates novel and relevant content based on the foundational training dataset. Developed by OpenAI, this chatbot is more than a simple conversational agent; it's a generative AI and its applications are numerous: writing books (Yanfang *et al.*, 2023), generating lines of code, performing tedious spreadsheet tasks, and more (Margaret *et al.*, 2023). Based on a written prompt, ChatGPT fulfils the given task, all the while learning and improving.

On the one hand, ChatGPT doesn't have real-time access to external databases or the internet to provide us with a list of specific articles related to Strategic DSS and Covid-19. However, it can suggest some keywords and topics that we can use to search for articles related to

“Strategic Decision Support Systems with Covid-19”. It proposes to search for these keywords in academic databases, research journals, and online platforms to find relevant articles:

- “Impact of Covid-19 on Strategic Decision Support Systems”.
- “Adapting Strategic Decision Support Systems to the Covid-19 Pandemic”.
- “Strategic Decision-Making in Times of Crisis: Covid-19 and Decision Support”.
- “Using Decision Support Systems for Crisis Management during Covid-19”.
- “Data-Driven Decision Making in the Face of Uncertainty: Covid-19 and Strategic Systems”.
- “Digital Transformation and Strategic Decision Support in the Post-COVID-19 Era”.

On the other hand, the integration of SDSS with ChatGPT to manage any crisis can offer unique opportunities for enhancing decision-making processes. What follows are some potential ways these technologies can be combined.

Real-time Scenario Analysis: Strategic DSS can provide comprehensive analysis of various scenarios, while ChatGPT can assist decision-making by generating explanations and interpretations of complex data. Together, they can provide real-time insights into different strategic choices.

Natural Language Interaction: ChatGPT can serve as a conversational interface for interacting with the strategic DSS. Decision-makers can ask questions in natural language, and ChatGPT can provide context-aware responses based on the data analysis from the DSS.

Simplifying Complex Insights: Strategic DSS often provides complex data and visualizations. ChatGPT can help simplify and summarize these insights, making them more accessible to a broader audience and aiding decision-making in understanding the implications.

Assistance in data interpretation: ChatGPT can assist decision-makers in interpreting data and analysis results generated by the DSS. It can answer queries related to the underlying data, methodologies, and potential outcomes of different strategic choices.

Scenario Exploration: Decision-makers can describe different scenarios to ChatGPT, and it can interact with the DSS to generate detailed projections and analyses for each scenario. This can help in comparing the potential outcomes of various strategic options.

Generating Decision Context: ChatGPT can generate summaries of relevant information, such as market trends, competitive landscape, and financial data, which can provide decision-makers with a quick overview before they delve into detailed DSS reports.

Supporting Collaborative Decision-Making: ChatGPT can facilitate communication and collaboration among decision-makers by summarizing key points, helping to reach a consensus, and ensuring that everyone understands the implications of the choices being considered.

Dynamic Recommendations: By integrating ChatGPT with the DSS, decision-makers can receive dynamic recommendations based on real-time changes in data and external factors, allowing them to make agile decisions.

When considering the integration of ChatGPT with a SDSS, it's important to ensure that the generated responses are accurate, transparent, and aligned with the intended use of the DSS. Proper validation, data governance, and feedback mechanisms should be in place to enhance the quality of decision-making facilitated by this combination.

The COVID-19 pandemic has led to a surge in the use of technology to address various challenges. Several advanced technologies can help in dealing with this viral disease, for instance ChatGPT. Yoshiyasu (2023) examines the influence of COVID-19 on mental health in the United States, utilizing an extensive CDC dataset and a novel approach involving generative AI to automatically produce Python code which was employed to analyse and visualize the evolving impact of COVID-19 on mental health across eight distinct categories over a span of time.

ChatGPT being a versatile language model has found applications in several areas related to the pandemic:

Information Dissemination: ChatGPT has been used to provide accurate and up to date information about COVID-19. It can answer questions about symptoms, preventive measures, testing locations, and other relevant topics.

Healthcare Assistance (Jaime, 2023): ChatGPT can assist in providing basic healthcare information and advice. It can help individuals understand when to seek medical attention, based on their symptoms and risk factors.

Mental Health Support (Yoshiyasu, 2023): The pandemic has had a significant impact on mental health. ChatGPT can offer support by providing coping strategies, relaxation techniques, and resources for managing stress and anxiety.

Education and Remote Learning (Yanfang *et al.*, 2023): With schools shifting to remote learning, ChatGPT can provide explanations, answer questions, and offer educational support to students studying from home.

Business Communication: ChatGPT can assist businesses in communicating changes in operations, safety protocols, and other relevant information to employees and customers.

Research and Development (Mohd *et al.*, 2023): Researchers have used ChatGPT to assist in analyzing COVID-19 data, generating hypotheses, and exploring potential treatment options.

Contactless Interfaces: ChatGPT can be used as a virtual assistant to reduce the need for physical contact in various settings, such as retail, customer service, and healthcare.

Policy Communication: Governments and health organizations can use ChatGPT to explain public health policies, guidelines, and regulations related to COVID-19.

Misinformation mitigation: ChatGPT can help counter misinformation by providing accurate information and fact-checking dubious claims related to the pandemic.

However, while ChatGPT offers valuable support, it's essential to recognize its limitations. It should not replace human medical professionals for diagnostics, treatment, or critical decision-making. It's crucial to verify information from reputable sources and use ChatGPT as a supplementary resource in managing the pandemic.

7

Discussion

In pandemic situations decision-makers face very complex scenarios, and the decisions made can have dramatic consequences on pandemic evolution. We can see in the literature that Strategic DSS were very well represented during the 1950's. Then, during the next 20 years, the literature was less abundant. The COVID-19 crisis encourages researchers to study and implement a strategic decision to deal with different pandemics. Furthermore, if we analyze the different SDSS that have been developed in this survey, we could use the following criteria:

- Group user based SDSS,
- Single user based SDSS,
- Methodology based SDSS,
- And software based SDSS.

According to these criteria, Table 7.1 presents an overview of the main classifications that could be found.

Table 7.1: Strategic decision support system classification

Simple user based SDSS	Group user based SDSS	Methodology based SDSS	Software based SDSS
Dung and Giang (2021)	Moormann and Lochte-Holtgreven (1993)	Agostino <i>et al.</i> (2020)	Moormann and Lochte-Holtgreven (1993)
Saaty (1990)	Kitsios and Kamariotou (2018a)	Dutton and Duncan (1987)	Belardo <i>et al.</i> (1994)
Hornby <i>et al.</i> (1994)	Yoo and Digman (1987)	Shahrooz <i>et al.</i> (2022)	Beraldi and Violi (2011)
Cooper and Kaplan (1999)	Korpela and Tuominen (1996)	Kitsios and Kamariotou (2018a)	Moormann and Lochte-Holtgreven (1993)
Sprague and Carlson (1982)	Zviran (1990)	Fanti <i>et al.</i> (2015)	Yoo and Digman (1987)
–	Finlay and Marples (1992)	Accorsi <i>et al.</i> (2014)	Korpela and Tuominen (1996)
–	Eden (1985)	Eden (1985)	Zviran (1990)
–	Yoo and Digman (1987)	Lee <i>et al.</i> (2002)	Hornby <i>et al.</i> (1994)
–	Jim and Lee (2002)	Alyoubi (2015)	Thierauf (1988)
–	–	Pietrzak <i>et al.</i> (2015)	Khalfan (2014)
–	–	Kitsios and Kamariotou (2018a)	Chinho and Hsieh (2003)
–	–	Yoo and Digman (1987)	Xiaodong <i>et al.</i> (2016)
–	–	Xiaodong <i>et al.</i> (2016)	–

This work studies the use of strategic DSS in a specific research setting and emphasizes the necessity for enhanced methods involving group collaboration and the use of Spatial Decision Support Systems (SDSS). These improved methods are crucial for better understanding and managing the complexities of the COVID-19 pandemic.

8

Conclusion

Many studies have been proposed and developed to deal with the COVID-19 pandemic. Each organization in the world has reacted to this crisis differently. Among them, some have adopted a DSS in their own activities to improve some technical aspects, whilst others have developed SDSS.

However, DSS have been used to assist managerial decision-making and managing a crisis effectively is an important component of deciding the level of crisis responsibility. The objective of this monograph is to review the existing literature and provide a comprehensive assessment on SDSS. Four criteria to classify the literature have been introduced: Group user based SDSS, Single user based SDSS, Methodology based SDSS, and Software based SDSS. Based on this analysis, we can see that Strategic DSS is more a matter of a group of a decision makers, and that they are supported more by methodologies rather than techniques.

Several advanced technologies can help in dealing with viral disease, for instance, ChatGPT. It's important to note that while ChatGPT can provide valuable support, it should not be a substitute for professional medical advice or expert guidance. Additionally, as the situation and understanding of COVID-19 evolves, the information provided

by ChatGPT should be cross referenced with reputable sources for accuracy.

This study also points to the need for a greater understanding of the strategic aspects of pandemic management, planning and the development of models to understand the implications of DSS under various pandemic scenarios. In fact, our research methodology can be reused with another example of crisis management as a framework.

References

- Accorsi, R., R. Manzini, and F. Maranesi (2014). “A decision-support system for the design and management of warehousing systems”. *Computers in Industry*. 65(1): 175–186.
- Agostino, B., M. Massei, and K. Sinelshnikov (2020). “Enabling strategic decisions for the industry of tomorrow”. *Procedia Manufacturing*. 42: 548–553. DOI: [10.1016/j.promfg.2020.02.028](https://doi.org/10.1016/j.promfg.2020.02.028).
- Ahmad, M., S. Sadiq, A. A. Eshmawi, A. S. Alluhaidan, M. Umer, and S. Ullah (2022). “Industry 4.0 technologies and their applications in fighting COVID-19 pandemic using deep”. *Computers in Biology and Medicine*. 145: 105418.
- Al-Maseb, H., M. Al-Sejari, and D. Kondrat (2023). “The effects of the COVID-19 pandemic on the lives and social daily life of married individuals during the total curfew in Kuwait”. *Journal of Affective Disorders Reports*. DOI: [10.1016/j.jadr.2023.100676](https://doi.org/10.1016/j.jadr.2023.100676).
- Alter, S. (1980). Addison-Wesley Publishing Co. 316. DOI: [10.1002/bs.3830270109](https://doi.org/10.1002/bs.3830270109).
- Alyoubi, B. A. (2015). “Decision support system and knowledge-based strategic management”. *Procedia Computer Science*. 65: 278–284.
- Andrews, K. R. (1980). *The Concept of Corporate Strategy*. Oxford. 52–59. DOI: [10.1093/oso/9780198781806.003.0005](https://doi.org/10.1093/oso/9780198781806.003.0005).

- Aussilloux, V. D., A. B. Mavridis, and M. Garrigue (2021). “The effects of the COVID-19 crisis on productivity and competitiveness”. Report published in France on the national productivity council.
- Bader, A. and P. D. Alyoubi (2015). “Decision support system and knowledge-based strategic management”. *Procedia Computer Science*. 65: 278–284.
- Barfod, M. B. and K. B. Salling (2015). “A new composite decision support framework for strategic and sustainable transport appraisals”. *Transportation Research*. 72: 1–15.
- Belardo, S., P. Duchessi, and J. R. Coleman (1994). “A strategic decision support system at Orell Fussli”. *Journal of Management Information Systems*: 135–157.
- Beraldi, P. and A. F. Violi (2011). “Simone a decision support system for strategic asset allocations”. *Published on Decision Support Systems*. 51(3): 549–561.
- Brem, A., E. Viardot, and P. A. Nylund (2021). “Implications of the coronavirus (COVID-19) outbreak for innovation: Which technologies will improve our lives?” *Technological Forecasting and Social Change*. 163: 120451. DOI: [10.1016/j.techfore.2020.120451](https://doi.org/10.1016/j.techfore.2020.120451).
- Carey, T. P. A. (1989). “Strategy formulation by banks”. *International Journal of Bank Marketing*.
- Cash, J., F. McFarlan, J. McKenney, and M. Vitali (1992). *Corporate Information Systems Management: Text and Cases*, Published by Irwin Professional Pub.
- Chamola, V., V. Hassija, V. Gupta, and M. Guizani (2020). “A comprehensive review of the COVID-19 pandemic and the role of IoT, drones, AI, blockchain, and 5G in managing its impact”. *IEEE Access: Practical Innovations, Open Solutions*: 90225–90265. DOI: [10.1109/ACCESS.2020.2992341](https://doi.org/10.1109/ACCESS.2020.2992341).
- Chinho, L. and P. Hsieh (2003). “A fuzzy decision support system for strategic portfolio management”. *Decision Support Systems*. DOI: [10.1016/S0167-9236\(03\)00118-0](https://doi.org/10.1016/S0167-9236(03)00118-0).
- Chon, M. G. and S. Kim (2022). “Dealing with the COVID-19 crisis: Theoretical application of social media analytics in government crisis management”. *Public Relations Review*. DOI: [10.1016/j.pubrev.2022.102201](https://doi.org/10.1016/j.pubrev.2022.102201).

- Chung, C. H., J. R. Lan, and K. N. Shaw (1989). “An approach for developing support systems for strategic decision making in business”. *Omega*: 135–146.
- Cooper, R. and R. S. Kaplan (1999). “The design of cost management systems: Text and cases”. *Prentice Hall*. 14(4): 730–731.
- Courtney, J. F. (2001). “Decision making and knowledge management in inquiring organizations: Toward a new decision-making paradigm for DSS”. *Decision Support Systems*: 17–38.
- Dung, L. and P. Giang (2021). “Strategic responses of the hotel sector to COVID-19: Toward a refined pandemic crisis management framework”. *International Journal of Hospitality Management*. 94: 102808.
- Dutton, J. E. and R. B. Duncan (1987). “The influence of the strategic planning process on strategic change”. *Strategic Management Journal*. 8(2). DOI: [10.1002/smj.4250080202](https://doi.org/10.1002/smj.4250080202).
- Eden, C. (1985). “Perish the thought!” *Journal of the Operational Research Society*. 36(9): 809–819.
- Elandaloussi, S. and P. Zaraté (2023). “A literature review enabling strategic decision support systems for crisis management”. In: *The Second Workshop on Collaboration in Knowledge Discovery and Decision Making. Decisioning*. Colombia, Popayan.
- Fanti, M. P., G. Iacobellis, W. Ukovich, V. Boschian, G. Georgoulas, and C. Stylios (2015). “A simulation based decision support system for logistics management”. *Journal of Computational Science*. 10: 86–96.
- Finlay, P. N. and C. Marples (1992). “Strategic group decision support systems a guide for the unwary”. *Long Range Planning*: 98–107.
- Gorry, G. A. and M. S. Morton (1989). “A framework for management information systems”. *Sloan Management Review*: 49–61.
- Grunig, J. E., L. A. Grunig, and D. M. Dozier (2002). *Excellent Public Relations and Effective Organizations*. Routledge: Copyright By Lawrence Erlbaum Associates, Inc.

- Hajimirzajana, A., M. Vahdat, A. Sadegheih, E. Shadkam, and H. El Bilali (2021). “An integrated strategic framework for large-scale crop planning: Sustainable climate-smart crop planning and agri-food supply chain management”. *Sustainable Production and Consumption*. 26: 709–732.
- Hax, A. C. and N. S. Majluf (1984). *Strategic Management: An Integrative Perspective*. 468.
- Henrik, N., A. Thompson, P. Lindahl, and G. Broman (2008). “Introducing strategic decision support systems for sustainable product-service innovation across value chains”. In: *Proceedings of Sustainable Innovation, Malmö, Sweden*.
- Hornby, R. E., P. A. Golder, and J. Williams (1994). “SDP: A strategic DSS”. *Decision Support Systems*: 45–51.
- Huang, J. J. (2009). “The evolutionary perspective of knowledge creation”. A mathematical representation”. *Knowledge-Based Systems*: 430–438.
- Jaime, A. (2023). “Can ChatGPT rescue or assist with language barriers in healthcare communication?” *Patient Education and Counseling*. 115. DOI: [10.1016/j.pec.2023.107940](https://doi.org/10.1016/j.pec.2023.107940).
- Jauch, L. R. and W. F. Glueck (1988). *Business Policy and Strategic Management*. McGraw-Hill. URL: [10.5465/ambpp.1972.4981324](https://doi.org/10.5465/ambpp.1972.4981324).
- Jaziri, R. and M. S. Miralama (2021). “The impact of crisis and disasters risk management in COVID-19 times: Insights and lessons learned from Saudi Arabia”. *Medicine and Public Health*. 18: 100705.
- Jessup, L. M. and S. Kukalis (1990). “Better planning using group support systems”. *Long Range Planning*: 100–105.
- Jim, Q. C. and S. M. Lee (2002). “An exploratory cognitive DSS for strategic decision making”. *Decision Support Systems*. DOI: [10.1016/S0167-9236\(02\)00139-2](https://doi.org/10.1016/S0167-9236(02)00139-2).
- Kamariotou, M., F. C. Kitsios, A. Michael, and V. Manthou (2017). “Strategic decision support systems for logistics in the agrifood industry”. In: *Proceedings of 8th International Conference on Information and Communication Technologies in Agriculture*. Chania, Greece.
- Khalfan, Z. A. (2014). “Strategic management model for academic libraries”. *Procedia*. DOI: [10.1016/j.sbspro.2014.07.080](https://doi.org/10.1016/j.sbspro.2014.07.080).

- Kitsios, F. and M. Kamariotou (2018a). “Decision support systems for strategic information systems planning: An approach for logistics strategic management”. 3(3–4): 207–221. DOI: [10.1504/IJSS.2018.100188](https://doi.org/10.1504/IJSS.2018.100188).
- Kitsios, F. and M. Kamariotou (2018b). “Decision support systems and strategic planning: Information technology and SMEs’ performance”. *International Journal of Decision Support Systems*. 3(1–2): 53–70.
- Klyver, K. and S. L. Nielsen (2021). “Which crisis strategies are (expectedly) effective among SMEs during COVID-19?” *Journal of Business Venturing Insights*. DOI: [10.1016/j.jbvi.2021.e00273](https://doi.org/10.1016/j.jbvi.2021.e00273).
- Komathi, K., B. Milne, M. von, C. Bullen, S. Marsh, and J. Crump (2024). “Public opinion on global COVID-19 vaccine procurement and distribution policies: A nationally representative survey in Aotearoa New Zealand 2022”. *Vaccine*. 42(6): 1372–1382.
- Korpela, J. and M. Tuominen (1996). “A decision support system for strategic issues management of logistics”. *International Journal of Production Economics*. 46: 605–620.
- Lederer, A. L. and V. Sethi (1988). “The implementation of strategic information systems planning methodologies”. *MIS Quarterly*. 12(3): 445–461.
- Lederer, A. L. and V. Sethi (1996). “Key prescriptions for strategic information systems planning”. *Journal of Management Information Systems*: 35–62.
- Lee, G. K., J. Lampel, and Z. Shapira (2020). “After the storm has passed: Translating crisis experience into useful knowledge”. *Organization Science*. 31: 1037–1051. DOI: [10.1287/orsc.2020.1366](https://doi.org/10.1287/orsc.2020.1366).
- Lee, J. M., I. Chen, R. C. Chen, and C. H. Chung (2002). “A target-costing based strategic decision support system”. *Journal of Computer Information Systems*: 110–116.
- Margaret, C. K., F. Gil, L. Joshua, and N. Heidi (2023). “Artificial intelligence in sport management education: Playing the AI game with ChatGPT”. *Journal of Hospitality, Leisure, Sport & Tourism Education*. 33. DOI: [10.1016/j.jhlste.2023.100456](https://doi.org/10.1016/j.jhlste.2023.100456).
- Meyer, N., T. Niemand, A. Davila, and S. Kraus (2022). “Biting the bullet: When self-efficacy mediates the stressful effects of COVID-19 beliefs”. *PLOS ONE*. 17: 1–16. DOI: [10.1371/journal.pone.0263022](https://doi.org/10.1371/journal.pone.0263022).

- Min, H. (2009). "Application of a decision support system to strategic warehousing decisions". *International Journal of Physical Distribution & Logistics Management*.
- Mohd, J., A. Haleem, and R. Pratap (2023). "ChatGPT for healthcare services: An emerging stage for an innovative perspective". *Benchmark Council Transactions on Benchmarks, Standards and Evaluations*. 3(1). DOI: [10.1016/j.tbench.2023.100105](https://doi.org/10.1016/j.tbench.2023.100105).
- Mohsen, A. (1988). *Improving the Effectiveness of Strategic Decision Making Using an Integrated Decision Support System*. Information and Software Technology.
- Moormann, J. and M. Lochte-Holtgreven (1993). "An approach for an integrated DSS for strategic planning". *Decision Support Systems*. 10(4): 401–411.
- Naseem, A., S. T. H. Shah, S. A. Khan, and A. W. Malik (2017). "Decision support system for optimum decision making process in threat evaluation and weapon assignment: Current status, challenges and future directions". *Annual Reviews in Control*. 43.
- Nemati, H. R., D. M. Steiger, L. S. Iyer, and R. T. Herschel (2002). "Knowledge warehouse: An architectural integration of knowledge management, decision support, artificial intelligence and data warehousing". *Decision Support Systems*: 143–161.
- Newkirk, H. E., A. L. Lederer, and C. Srinivasan (2003). "Strategic information systems planning: Too little or too much?" *The Journal of Strategic Information Systems*: 201–228.
- Nonaka, I. and H. Takeuchi (1995). "The knowledge-creating company: How Japanese companies create the dynamics of innovation". *Journal of International Business Studies*. 27(1): 196–201.
- Peppard, J. and J. Ward (2004). "Beyond strategic information systems: Towards an IS capability". *The Journal of Strategic Information Systems*: 167–194.
- Pietrzak, M., K. Jałosiński, J. Paliszkiwicz, and A. Brzozowski (2015). "A case study of strategic group map application used as a tool for knowledge management". *Journal of Computer Information Systems*: 68–77.

- Rezaie, A., R. D. Parker, and M. Abdollahi (2007). *Oxidative Stress and Pathogenesis of Inflammatory Bowel Disease: An Epiphenomenon or the Cause?* Vol. 52. 2015–2021.
- Saaty, T. L. (1990). “The analytic hierarchy process in conflict management”. *International Journal of Conflict Management*.
- Schendel, D. and C. W. Hofer (1979). “Strategic management: A new view of business policy and planning”. *Little, Brown, Boston*. 25(3): 536–543.
- Scott Morton, M. S. (1986). “Strategy formulation methodologies”. CISR WP No. 149, Sloan WP No. 1845-86, 90s WP No. 86-028.
- Shahparvari, S., B. Hassanizadeh, A. Mohammadi, B. Kiani, K. H. Lau, P. Chhetri, and B. Abbasi (2022). “A decision support system for prioritised COVID-19 two-dosage vaccination allocation and distribution”. *Transportation Research*. 159: 102598. DOI: [10.1016/j.tre.2021.102598](https://doi.org/10.1016/j.tre.2021.102598).
- Shahrooz, S., B. Hassanizadeh, A. Mohammadi, B. Kiani, K. Hung Lau, P. Chhetri, and B. Abbasi (2022). “A decision support system for prioritised COVID-19 two-dosage vaccination allocation and distribution”. *Transportation Research Part E*. 159: 102598.
- Sharma, G. D., S. Krausb, M. Srivastavad, R. Chopraa, and A. Kallmuenzere (2022). “The changing role of innovation for crisis management in times of COVID19: An integrative literature review”. *Behalf of Journal of Innovation & Knowledge*. DOI: [10.1016/j.jik.2022.100281](https://doi.org/10.1016/j.jik.2022.100281).
- Shuliang, L., Z. L. Jim, and H. Hong (2011). “WebDigital: A web-based hybrid intelligent knowledge automation system for developing digital marketing strategies”. *Expert Systems with Applications*. 38: 10606–10613.
- Simon, H. A. (1960). “The new science of management decision”. *Harper & Brothers*. DOI: [10.1037/13978-000](https://doi.org/10.1037/13978-000).
- Sprague, R. H. and E. D. Carlson (1982). *Building Effective Decision Support Systems*. Prentice Hall Professional Technical Reference.
- Stephen, R. N. and K. Witkowski (2024). “Belief in misinformation and acceptance of COVID-19 vaccine boosters: A survey analysis”. *PEC Innovation*. DOI: [10.1016/j.pecinn.2024.100261](https://doi.org/10.1016/j.pecinn.2024.100261).

- Thierauf, R. J. (1988). “User-oriented decision support systems: Accent on problem finding”. *International Journal of Business Intelligence Research*: 38–52.
- Tunčikienė, Z., J. Bivainis, and R. Drejeris (2010). “Integrated DSS for strategic planning in public institutions”. *Journal of Business Economics and Management*. 11(4): 671–688.
- Wamba, S. F., A. Gunasekaran, S. Akter, and R. Dubey (2020). “The performance effects of big data analytics and supply chain ambidexterity: The moderating effect of environmental dynamism”. *International Journal of Production Economics*. 222: 423–444.
- Warwick, M. and R. Fernando (2023). “The global economic impacts of the COVID-19 pandemic”. *Economic Modelling*. DOI: [10.1016/j.econmod.2023.106551](https://doi.org/10.1016/j.econmod.2023.106551).
- Waxlax, J. (1993). “An object-oriented DSS for strategic management”. *Computers & Industrial Engineering*. 25(1–4): 573–576.
- Wehrich, H. (1982). “The TOWS matrix-a tool for situational analysis”. *Long Range Planning*. 15(2).
- Xiaodong, L., D. Ouelhadj, X. Song, D. Jones, G. Wall, K. E. Howell, P. Igwe, S. Martin, D. Song, and E. Pertin (2016). “A decision support system for strategic maintenance planning in offshore wind farms”. *Renewable Energy*. DOI: [10.1016/j.renene.2016.07.037](https://doi.org/10.1016/j.renene.2016.07.037).
- Yanfang, S., L. Yun, and L. Chun (2023). “Collaborating with ChatGPT in argumentative writing classrooms”. *Assessing Writing*. 57: 100752. DOI: [10.1016/j.asw.2023.100752](https://doi.org/10.1016/j.asw.2023.100752).
- Ye, F., K. Liu, L. Li, K. Lai, Y. Zhan, and A. Kumar (2022). “Digital supply chain management in the COVID-19 crisis: An asset orchestration perspective”. *International Journal of Production Economics*. 245: 108396.
- Yoo, S. and L. A. Digman (1987). “Decision support system: A new tool for strategic management”. *Long Range Planning*: 114–124.
- Yoshiyasu, T. (2023). “Impact of COVID-19 on mental health in the US with generative AI”. *Asian Journal of Psychiatry*. 88. DOI: [10.1016/j.ajp.2023.103736](https://doi.org/10.1016/j.ajp.2023.103736).

- Yu-Pei, Y., P. Shuang-Jun, Z. Mei-Xian, C. Hai-Xiao, and T. Tao-Hsin (2023). “The impact of COVID-19 pandemic on healthcare workers under the ‘Ten New Guidelines’ in Taizhou”. *Preventive Medicine Reports*. DOI: [10.1016/j.pmedr.2023.102550](https://doi.org/10.1016/j.pmedr.2023.102550).
- Zviran, M. (1990). “ISSPSS: A decision support system for information systems strategic planning”. *Information & Management*. 19(5): 345–359.