



HAL
open science

Low-carbon hydrogen production in the european union : what economic conditions are required to switch to low-carbon hydrogen by 2030?

Boigontier Thomas, Robin Girard, Julien Lamarque-Lacoste, Manon de la Motte Saint Pierre, Théo Mange

► To cite this version:

Boigontier Thomas, Robin Girard, Julien Lamarque-Lacoste, Manon de la Motte Saint Pierre, Théo Mange. Low-carbon hydrogen production in the european union : what economic conditions are required to switch to low-carbon hydrogen by 2030?. Ecole nationale Supérieure des mines de Paris. 2023. hal-04702712

HAL Id: hal-04702712

<https://hal.science/hal-04702712v1>

Submitted on 19 Sep 2024

HAL is a multi-disciplinary open access archive for the deposit and dissemination of scientific research documents, whether they are published or not. The documents may come from teaching and research institutions in France or abroad, or from public or private research centers.

L'archive ouverte pluridisciplinaire **HAL**, est destinée au dépôt et à la diffusion de documents scientifiques de niveau recherche, publiés ou non, émanant des établissements d'enseignement et de recherche français ou étrangers, des laboratoires publics ou privés.



PSL 



THE HYDROGEN SERIES – PART 3
REPORT
DECEMBER 2023

LOW-CARBON HYDROGEN PRODUCTION IN THE EUROPEAN UNION :

WHAT ECONOMIC CONDITIONS ARE REQUIRED TO
SWITCH TO LOW-CARBON HYDROGEN BY 2030?

In Part 1 of our Hydrogen series, the great variety of hydrogen production routes and technologies were presented and compared based on their maturity and performances.

Part 2 was dedicated to the analysis and comparison of 2030 EU's targets in terms of renewable hydrogen production with the pipeline of projects.

Part 3 discusses the economic conditions that will allow current fossil hydrogen users to switch to low-carbon hydrogen.

CONTENTS

1.	From the current hydrogen users' standpoint	3
2.	Methodology and detailed assumptions	5
3.	Technological and industrial challenges of electrolyser CAPEX	15
4.	Switching conditions: renewable electricity production and supply model	16
5.	Switching conditions: natural gas and CO ₂ prices	18
6.	Switching conditions: project financing	20
	Conclusion	22
	Bibliography	23

1. From the current hydrogen users' standpoint

1.1 Current hydrogen users

In 2020, 82%¹ of the 8.7 million tons of hydrogen (H₂) demand in Europe were used not as an energy vector but as a chemical input by two main industries:

- **Refining industry (4.4 Mt)** uses hydrogen as a chemical reagent to reduce the fuels' sulphur levels and to lighten heavy hydrocarbons. Some refineries also use hydrogen in their crude oil transformation process for hydrocracking or hydrotreatment to refine diesel and kerosene.
- **Ammonia industry (2.5 Mt)** combines dihydrogen (H₂) with dinitrogen (N₂) to synthesize ammonia (NH₃) used as a raw material for fertilizer production.

The remaining 18% of hydrogen is currently consumed by the chemical industry for methanol production (CH₃COH) and for other industrial processes such as steel production, electronic components manufacturing, glass manufacturing...

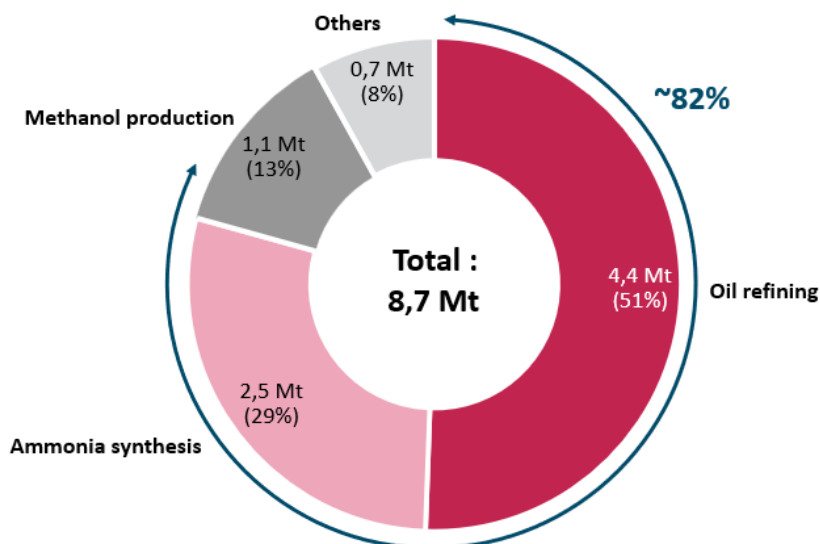

Figure 1 – Hydrogen consumption in Europe [Mt; 2020]¹

In 2020, 91% of the European hydrogen production capacity relied on fossil fuels as feedstocks, mainly through Steam Methane Reforming technologies and less commonly through Partial Oxidation (POX) or Auto-Thermal Reforming (ATR). The same year, this production generated more than 80 million tons of CO₂ (2.5% of total EU-27 emissions) – cf. part 1 of our Hydrogen series.

Decarbonizing hydrogen production in Europe by 2030 implies for the two main current users **to switch to low-carbon hydrogen production technologies**. Such change may serve as a knock-on effect to lead the growth dynamics in the European Union to achieve REPowerEU targets. As a reminder, the EU aims at producing 10 Mt of renewable hydrogen by 2030 compared to 0.012 Mt in 2020 and import an additional 10 Mt from other countries (cf. part 2 of our Hydrogen series).

Multiple low-carbon hydrogen production routes exist but not all the associated technologies are mature enough to reach commercial scale by 2030 (cf. part 1 of our Hydrogen series). **Europe focuses on electrolysis-based technologies** (a.k.a. “green hydrogen”) with all the consequences it implies on European renewable electricity capacity scale-up. In this context, hydrogen production based on carbon capture system (a.k.a. “blue hydrogen”) could be considered as a complementary way to achieve EU decarbonization goal (cf. part 2 of our Hydrogen series, but also recent journal publications such as Shirizaeh et al.² and Jodry et al.³).

Beyond the technological and industrial challenges of low-carbon hydrogen production, the **competitiveness of the levelized cost of hydrogen (LCOH)** is also a key enabler of transition dynamics.

1.2 Proposed approach to assess switching costs

This study endorses the **standpoint of a current consumer** (either oil refinery or ammonia producer) **assessing the opportunity to switch to low-carbon hydrogen**.

Even though many factors are influencing the choice of the consumer regarding its hydrogen supply (such as regulation, brand image associated with the environmental impact of the company operations, availability of the supply chain ...), the main barrier to switch to low-carbon hydrogen still lies with its cost of production. The objective of this report is to analyse **under which economic conditions low-carbon hydrogen would be cost-competitive compared to conventional SMR production-based hydrogen in Europe by 2030**, or more generally how much more a consumer would have to pay to lower its CO₂ emissions by switching to low-carbon hydrogen.

Even though a large variety of set-ups could be considered to produce hydrogen, the **three following cases have been selected as they will most likely be the only available technologies by 2030 to produce H₂ at an industrial scale** (cf. part 1 of our Hydrogen series).

- A** Steam Methane Reforming (SMR)
- B** Steam Methane Reforming (SMR) with a Carbon Capture and Storage (CCS) system
- C** Alkaline electrolysis with dedicated renewable electricity production (offshore wind power plant)

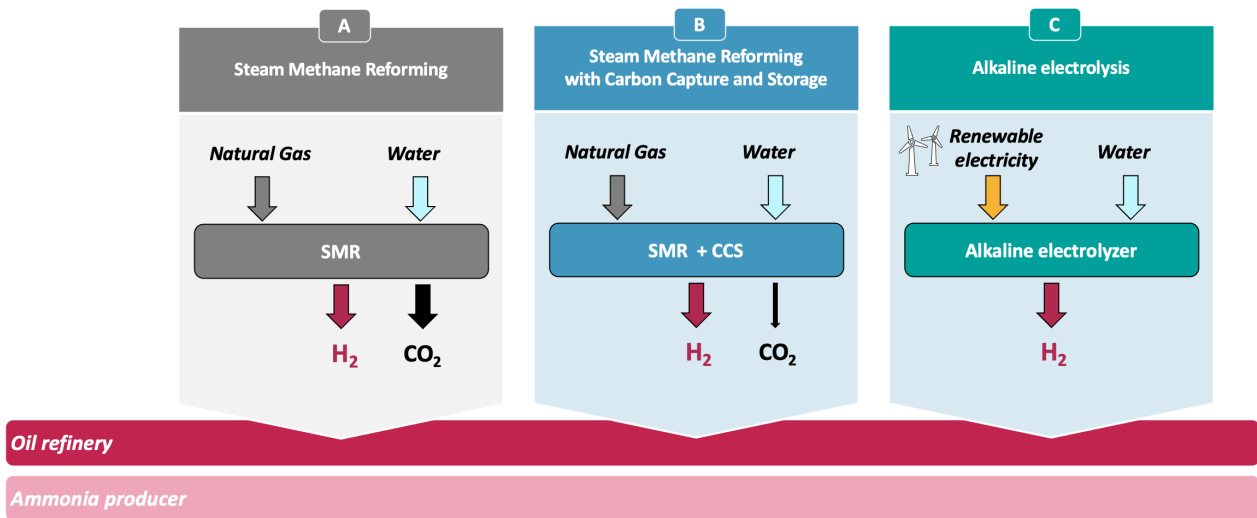

Figure 2 – Hydrogen production scenarios considered in this study

For each of these scenarios, the sensitivity of the levelized cost of hydrogen (LCOH) to the following parameters is assessed and discussed:

- Electrolysers CAPEX and capacity factor
- European renewable electricity price (LCOE)
- European natural gas price
- European CO₂ allowance price (ETS market)
- Discount rate (WACC)

2. Methodology and detailed assumptions

2.1 Levelized cost methodology

In this study, hydrogen production cost calculation is based on the standard method of “Levelized cost of energy”. The resulting LCOH corresponds to the **minimum hydrogen price allowing to reach the hydrogen production plant profitability threshold over its lifetime.**

Net Present Value (NPV)
of hydrogen production plant

=

Sum of **discounted revenues**
from hydrogen production
over the plant lifetime

-

Sum of **discounted costs**
of hydrogen production
over the plant lifetime

=

$$\sum_{t=1}^n \frac{\text{LCOH} \times H_t}{(1 + \text{WACC})^t}$$

-

$$\sum_{t=1}^n \frac{\text{CAPEX}_t + \text{OPEX}_t + I_t}{(1 + \text{WACC})^t}$$

Based on this equation, the LCOH is defined as the minimum value that makes the NPV equals to zero:

$$\text{LCOH} \quad (\text{€/kg}) = \frac{\sum_{t=1}^n \frac{\text{CAPEX}_t + \text{OPEX}_t + I_t}{(1 + \text{WACC})^t}}{\sum_{t=1}^n \frac{H_t}{(1 + \text{WACC})^t}}$$

- **n** = hydrogen plant lifetime (in years). It varies with the hydrogen production plant capacity factor. An electrolyzer is meant to operate for a maximum number of hours over its lifetime. For example, a capacity factor of 100% results in the plant lasting 8 years while a capacity factor of 50% results mathematically in a plant lasting 16 years. Plant lifetime is a key economic driver: the longer the investment period is, the more the project is exposed to market conditions volatility.
- **WACC** = weighted cost of capital (in %) associated to the investment. It reflects the financing cost of the project that varies with the associated level of risks (enterprise, geographical, project strategy). WACC may differ from a hydrogen production project to another depending on the selected technology as it can be considered more or less risky from an investor's perspective. LCOH sensitivity to WACC level is discussed in chapter 6.
- **CAPEX** = capital expenditure (in €) for hydrogen production equipment (depending on technology selected, including Carbon Capture and Storage system when required). A 3-years period is considered for equipment setting.
- **OPEX** = operational expenditure (in €/kg H₂ produced) for recurring hydrogen production plant operation and maintenance costs (% of CAPEX). No H₂ transportation costs are considered as the distance between production and consumption is supposed < 10 km through existing pipes.
- **I_t** = feedstock, water, natural gas or electricity costs depending on the hydrogen production technology
- **H_t** = quantity of hydrogen produced annually (in kg)

Following assumptions for LCOH calculation have been set considering an **investment start date in 2025 under European conditions**.

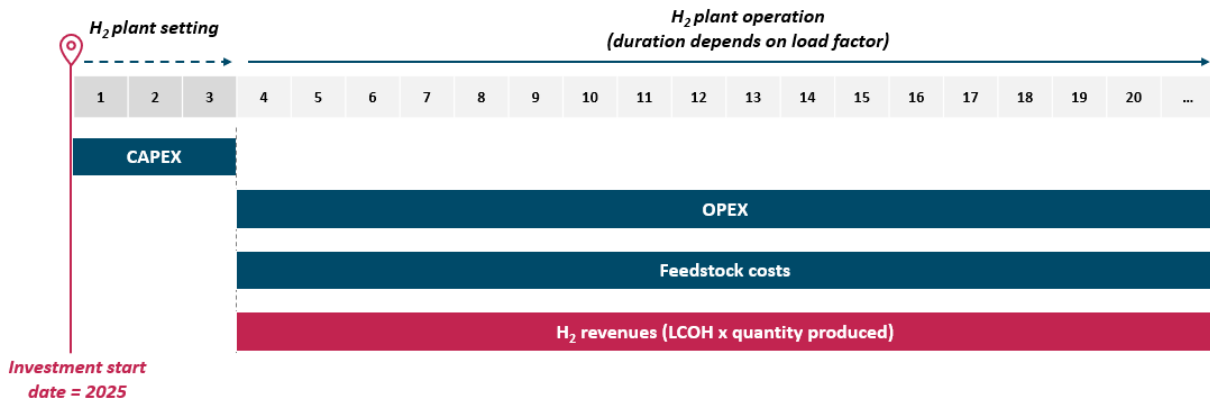

Figure 3 – Costs and revenues over the hydrogen plant lifetime for LCOH calculation

2.2 Scenario A: hydrogen production through SMR technology with no CCS system

Scenario A is representative of the **current hydrogen production plants in Europe**. SMR consists in an endothermic reaction (heat must be supplied to the process) between methane and steam water under 3 – 25 bar of pressure and high temperatures (700°C to 1000 °C) activated by a catalyst (usually nickel). Due to the high H₂ quantities consumed continuously for fuel refinery or ammonia synthesis, **SMR plants are usually located close to the end-user plant** and H₂ transport is made through dedicated pipes shorter than a few kilometers.

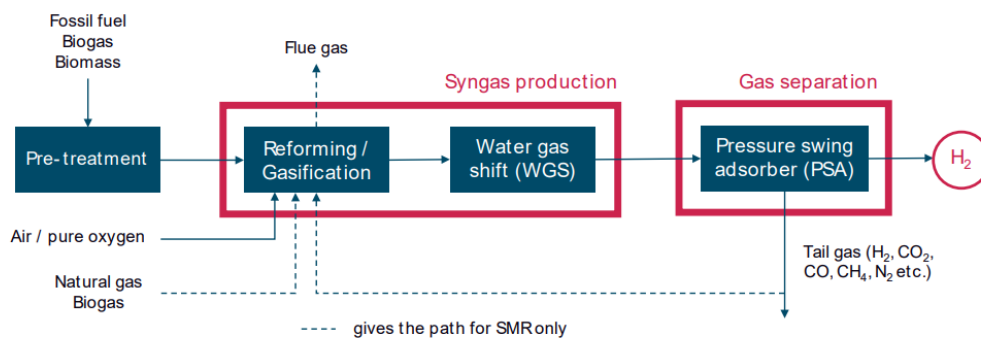

Figure 4 – Simplified industrial process for hydrogen production through SMR

Key parameters for scenario A	Assumptions ⁴
Technology	Steam Methane Reforming (SMR)
Carbone Capture and Storage system	No
Plant capacity factor	90%
Plant lifetime	20 years
Plant setting lead time	3 years
Process energy efficiency (LHV)	76% ⁴
Unit CAPEX for SMR plant (full system)	760 €/ kW H ₂ ⁵
SMR plant OPEX	4,7% of CAPEX per year ⁴
Water consumption	7 L/kg H ₂
Water cost	4 € / m ³
H ₂ transport and distribution cost	0 € (use of existing pipes < 15 km)

2.3

Scenario B: hydrogen production through SMR technology with CCS system

Scenario B is similar to Scenario A except that it includes a Carbon Capture and Storage (CCS) system in addition to the SMR infrastructure. As detailed in part 1 of our Hydrogen series, there are **three different locations where carbon capture units can be installed**, with varying capture rates for each location.

When set after the water gas shift (WGS) or the pressure swing adsorber (PSA), 56% capture rates can already be achieved as **60% of the total CO₂ of the process is contained in the syngas⁴**. The advantage with these options is that the CO₂ concentration and the pressure is high and that there is no oxygen which makes the capture quite easy and cheap. Some SMR facilities have already implemented such carbon capture units such as the Port-Jerome CRYOCAP H₂ facility in France in operation since 2015.

To be able to capture the emissions of the whole process, the carbon capture unit must be located after the reformer, as it is usually heated with the tail gas and some natural gas. This option is however **less mature** than the two previous ones because the CO₂ concentration and the pressure are low, temperatures are high and oxygen is also present which makes it more difficult and expensive to capture CO₂. For the moment, no industrial facility has implemented a carbon capture unit after the reformer as it is currently not cost-effective, but this could change soon as carbon prices increase. **Recent literature indicates that 90% carbon capture is already possible⁶** (see Hydrogen series part 1) which would make the hydrogen produced “low carbon” according to the EU latest delegated acts⁷.

The carbon capture in scenario B is thus considered **to capture 90% of the CO₂ emitted by the whole process**. As CCS consumes energy to function, the total energy consumption increases making the **global efficiency drop from 78% to 69%⁶** meaning that **more natural gas is required** as an input to produce an equal amount of hydrogen.

Industrial feedbacks confirms that downstream OPEX for transport, storage and treatment of captured CO₂ are often underestimated. 50€/ton of captured CO₂ in Scenario B has thus been considered whereas 20 USD/ton is generally assumed in IEA reports.

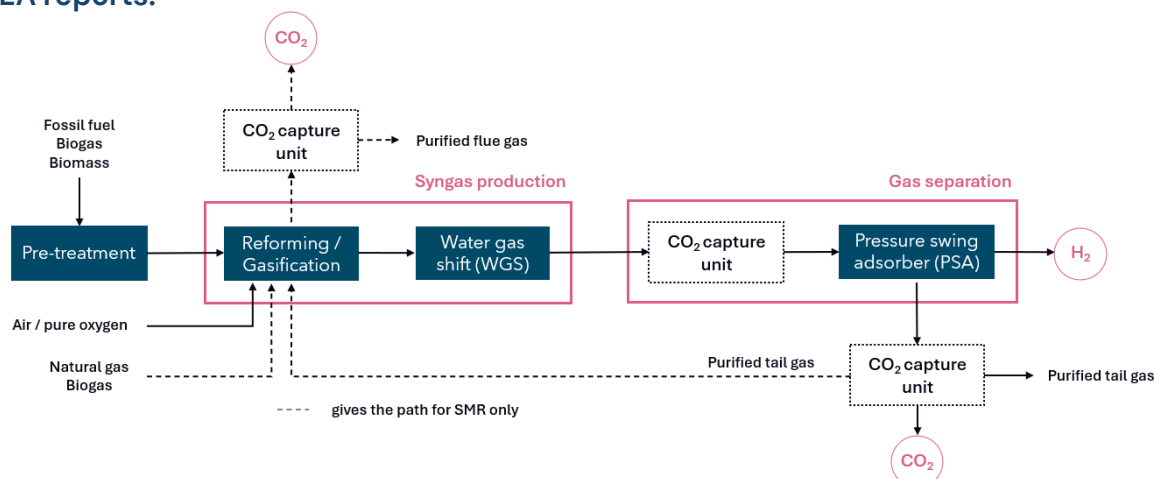

Figure 5 – Simplified industrial process for hydrogen production through SMR + CCS

Key parameters for scenario B	Assumptions ²	vs. scenario A
Technology	Steam Methane Reforming (SMR)	=
Carbone Capture and Storage (CCS) system	Yes	=
Plant capacity factor	90%	=
Plant lifetime	20 years	=
Plant setting lead time	3 years	=
Process energy efficiency (LVH)	69% ⁴	←
Unit CAPEX for SMR plant (full system)	760 €/ kW H ₂ ⁵	=
OPEX	4,7% of CAPEX per year ⁴	=
Water consumption	7 L/kg H ₂	=
Water cost	4 € / m ³	=
H ₂ transport and distribution cost	0 € (existing pipes < 10 km)	=
CCS CAPEX	642 €/kW H ₂ ⁵	←
CCS OPEX	3% of CAPEX per year ⁵	←
CO ₂ transport, storage and treatment	50 €/t CO ₂	←
CO ₂ capture rate	90% ⁴	←

Another option to reduce the emissions of SMR could be electrifying the furnace providing heat to the reformer, instead of burning natural gas. eSMR has a lot of advantages⁸ (simpler plant design, reduced fossil fuel dependency, better efficiency, faster transient operation and start-up, smaller footprint...). However, the technology is still in its infancy (TRL 4 according to the IEA⁹) as only small prototypes have been built to this day, like this FOTK pilot-plant using Topsoe eREACT technology⁸ located in Aarhus University in Denmark which gave encouraging results. Regarding the time horizon of this study, it is not relevant to consider eSMR as it won't be available at scale before 2030.

Auto-thermal reforming (ATR) is also not considered in this scenario because of its current very limited share of H₂ production in Europe despite its high maturity level and good performances (cf. part 1 of our Hydrogen series). It is worth mentioning that ATR technology could be preferred for carbon capture (only one concentrated flux), has a higher CAPEX (around +15%) but consumes less natural gas (-30%) than SMR+CCS. In the case of a system with CCS, this results in a smaller cost for ATR when compared to that of SMR+CCS (see Oni et al.¹⁰ for a more detailed analysis on ATR).

2.4 Scenario C: alkaline electrolysis with dedicated renewable electricity plant

Scenario C consists in producing **hydrogen through electrolysis directly powered by a dedicated fixed-bottom offshore wind farm with no electrical storage equipment**. This case corresponds to one of the multiple industrial configurations that can be considered regarding electrolysis-based hydrogen production (e.g. Project of 100 MW electrolyser developed by Orsted and Yara International in Denmark to produce 75 ktons/year of ammonia¹¹).

It is compliant with the current European definition of “renewable hydrogen”. Alternative configurations are discussed in chapter 4.

This study focuses on **alkaline electrolysis (ALK) technology** as it is one the most mature by the time horizon of the study (2025–2030) and currently has the biggest market share (58% of installed capacity in 2022¹²). However, Proton Exchange Membrane (PEM) technology could have also been considered as it is as mature. But PEM CAPEX are still higher than ALK (1700 \$/kW vs. 2000 \$/kW in 2023¹³) and PEM process efficiency is still lower (63% vs. 66% in 2025) than ALK.

Downstream H₂ storage cost is not considered in the LCOH calculation as it represents only 0.1–0.2 €/kg H₂ depending on the flexibility required by the Haber Bosh process for ammonia synthesis and plant location.

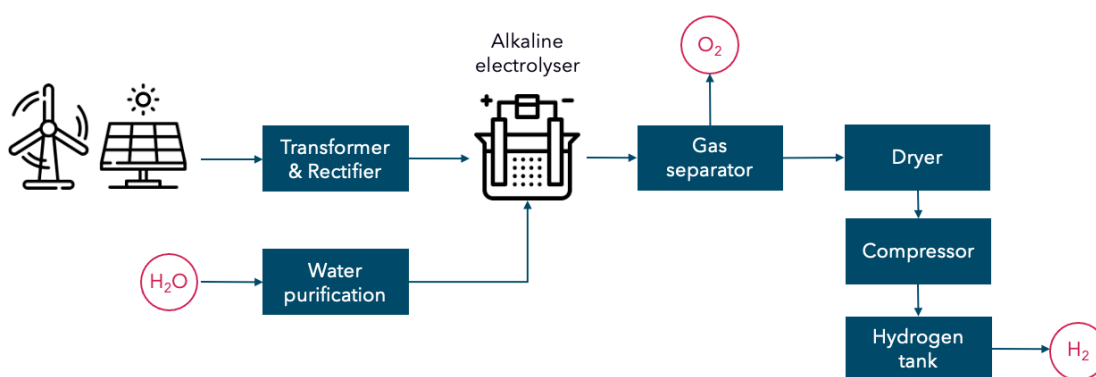

Figure 6 – Simplified industrial process for hydrogen production through alkaline electrolysis

Key parameters for scenario C	Assumptions ⁴
Technology	Alkaline electrolyser
Carbone Capture and Storage (CCS) system	No
Plant capacity factor (with overbuilding)	51% ¹⁴
Electrolyser lifetime	35 years (140 000 hours) ¹⁵
Plant setting lead time	3 years
Stack lifetime	19 years
Process energy efficiency – 2025	55 kWh/kg H ₂ ¹⁵
Unit CAPEX for electrolysers (full system) - 2025	800 €/ kW (C1) or 1050 €/kW (C2) ¹³
Stack replacement CAPEX – 2040	200 €/ kW
OPEX	1,5 % of the CAPEX per year ¹²
Water consumption	10 L/kg H ₂
Water cost	4 € / m ³
Transport and distribution cost	0 € (existing pipes < 10 km)
Capacity factor of wind offshore dedicated farm	46%
LCOE from wind offshore plant	45 €/MWh

CAPEX (as well as efficiency) is constant over the investment period as LCOH calculations refer to a given start date of investment (here 2025). The economic benefit of CAPEX decrease (or efficiency increase) based on a learning curve would only be visible through LCOH comparison at different start dates (LCOH₂₀₂₅ vs. LCOH₂₀₃₀ for example).

LCOE of the fixed-bottom wind offshore plant is assumed at 45 €/MWh in 2025 as IEA¹⁶ forecasts that LCOE of offshore wind in the EU in 2030 would be in the range of 35–65 €/MWh (including transmission, with a 4% WACC, EUR–USD exchange rate of 1.1). It is an ambitious objective as the average LCOE of newly commissioned offshore wind farm in Europe in 2021 was around 60 €/MWh¹⁷. Main costs-components of offshore wind are expected to decrease in the next decade, mainly driven by technology improvements and larger turbine sizes. However, LCOE also depends on plant location and associated cost of capital (WACC). Sensitivity to renewable electricity price is discussed in chapter 4.

2.5 Standard hydrogen users' profile

The purpose of the study is to discuss European low-carbon hydrogen economic conditions from current industrial users' standpoint. Thus, **two "standard" users are considered: a large oil refinery and an ammonia plant both requiring 80 000 tons of hydrogen annually** as an input for their industrial processes.



	 LARGE OIL REFINERY	 AMMONIA PRODUCER
<i>Average annual plant production</i>	15-20 Mt petroleum output 71% of EU refineries produce more than 9 Mt of petroleum output per year	440 kt NH₃ 68% of EU ammonia plants produce more than 250 kt/year
<i>Average H₂ production</i>	80 kt H₂ + 20 kt By-product H ₂ through large refinery process and self-consumed	80 kt H₂ No by-product H ₂ produced through industrial process
<i>CO₂ emissions from H₂ production</i>	800 kt CO₂ Representing ~15-19% of total refinery process emissions	800 kt CO₂ Representing 100% of total ammonia production emissions
<i>European plants</i>	75 refineries Mainly located in the North Sea and Mediterranean Sea coasts and Central Europe	42 plants Mainly located in the Nordic and Atlantic coastlines and East-Central Europe

Figure 7 – Hydrogen standard users characteristics

In this specific context, hydrogen production in Scenario A and B would require a **340 MWh H₂ Steam Methane Reforming** equipment (e.g., Gonfreville refinery in Normandy) and a **1 GWe electrolyser** in Scenario C. Most alkaline electrolysers installed in Europe in 2020 are in the range of 20 MW–100 MW (e.g., Djewels in the Netherlands equipped by McPhy). According to the 2023 IEA Global Hydrogen Review, the average size of electrolysers is expected to reach hundreds of MW in a few years and the GW scale by 2030. Moreover, **GW scale electrolysers are already expected for projects as soon as 2025¹⁸**. Also, **HyDeal ambition** in Spain is one of the most ambitious and advanced projects with a production target of 150 kt of renewable hydrogen per year by 2026. The project should start with **3.3 GWe electrolysers connected to an expected 4.8 GWe solar farm** and supply hydrogen for both industrial traditional needs and new uses as mobilities⁴.

2.6

Assumptions for natural gas prices in Europe

Natural gas (NG) supply in Europe was significantly affected by the Russia-Ukraine war in the past 2 years leading to an unprecedented increase in supply costs (133 €/MWh in average in 2022 compared to 12 €/MWh in 2020). This event raised the issue of Europe dependency to other countries for its own energy supply and lead to massive Liquefied Natural Gas (LNG) imports from the United States.

Because of the high stock levels and the lower than expected demand due to higher temperatures, NG prices dropped down to 42 €/MWh on average over the first semester of 2023. Even though European governments are anticipated NG purchase for next winter, tensions remain on this market over the next years.

In this context, 40 €/ MWh is considered for natural gas prices as “base case” for LCOH calculation in Scenario A and B.

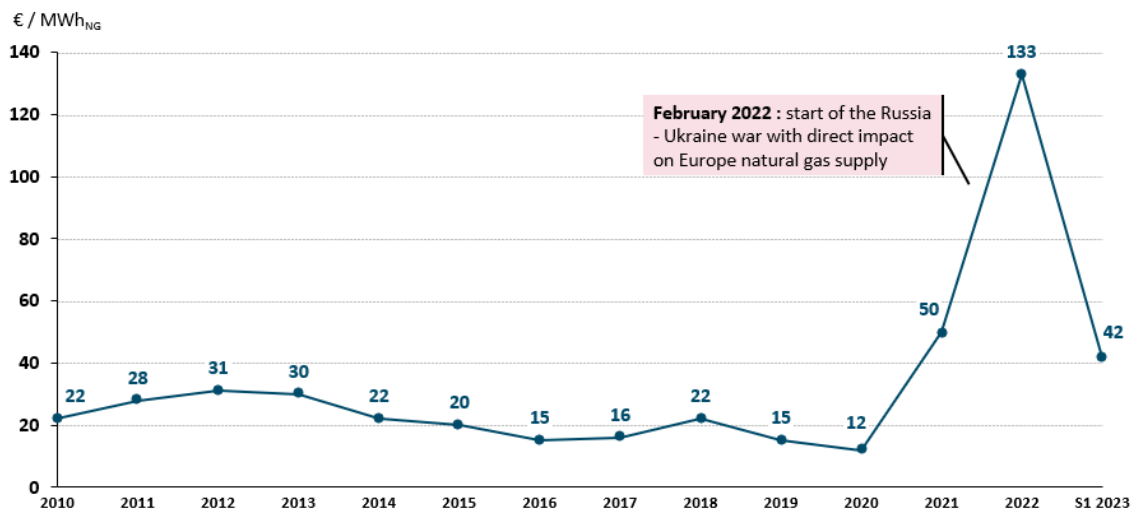

Figure 8 – Natural gas prices evolution in Europe [2010–2023, €/MWh] (source: Dutch TFF)

2.7

Assumption for accounting CO₂ emissions costs

Since 2005, the European Union has been setting up the Emissions Trading System (ETS) to encourage the reduction of CO₂ emissions from the energy and industry sectors. It consists in capping the total amount of greenhouse gases that can be emitted by a given installation. This cap is then progressively reduced over time. Emissions allowances (a.k.a. “quotas”) were also delivered to industries where emissions are hard to abate. As the total number of allowances is finite, it gives them a market value so that they can be traded between operators depending on their needs through dedicated trading platforms. CO₂ allowance prices are determined by the law of supply and demand, although the European Commission can influence ETS market trends by accelerating cap reduction.

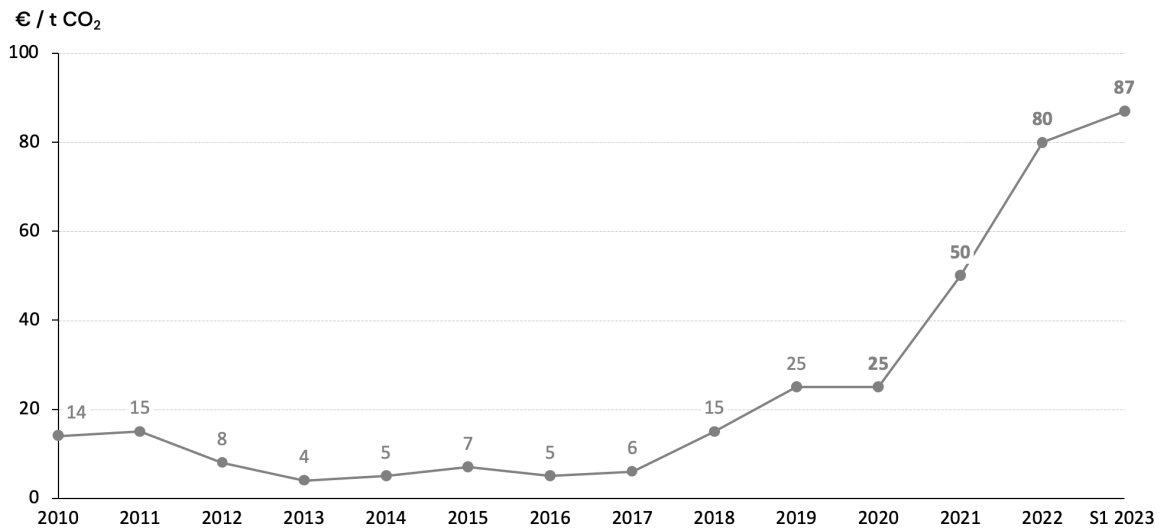

Figure 9 – EU ETS price evolution [2020–2023, €/ton CO₂]²⁰

EU ETS market price has increased strongly (x3.5) since 2020 to reach 87 €/ton CO₂ in average over S1 2023, mainly driven by the coal-based energy production increase in the context of natural gas shortage in Europe.

Considering the low visibility on CO₂ market price evolution in the coming years, 100 €/ton CO₂ has been assumed as the average EU ETS price over the H₂ plant lifetime (2025–2045) in the “base case”. Indeed, the EU forecasts²¹ an increase to 120–130 €/ton CO₂ by 2030. Based on this data point and assuming a constant growth rate over the H₂ plant lifetime, it results in an average discounted EU ETS price around 100€/ton CO₂ (discount rate of 5%). Besides, 100 €/ton corresponds to the initial 2030 target set by the EU in 2008.

Decreasing CO₂ allowances are considered (cf. Figure 10) over the investment period. In Scenario A, if CO₂ emissions exceed the assumed CO₂ allowance cap, then additional purchasing costs of complementary allowances are considered in the LCOH. In both Scenario B and C, allowance surplus generated by low-carbon production processes compared to the Scenario A are considered as additional revenues in the LCOH.

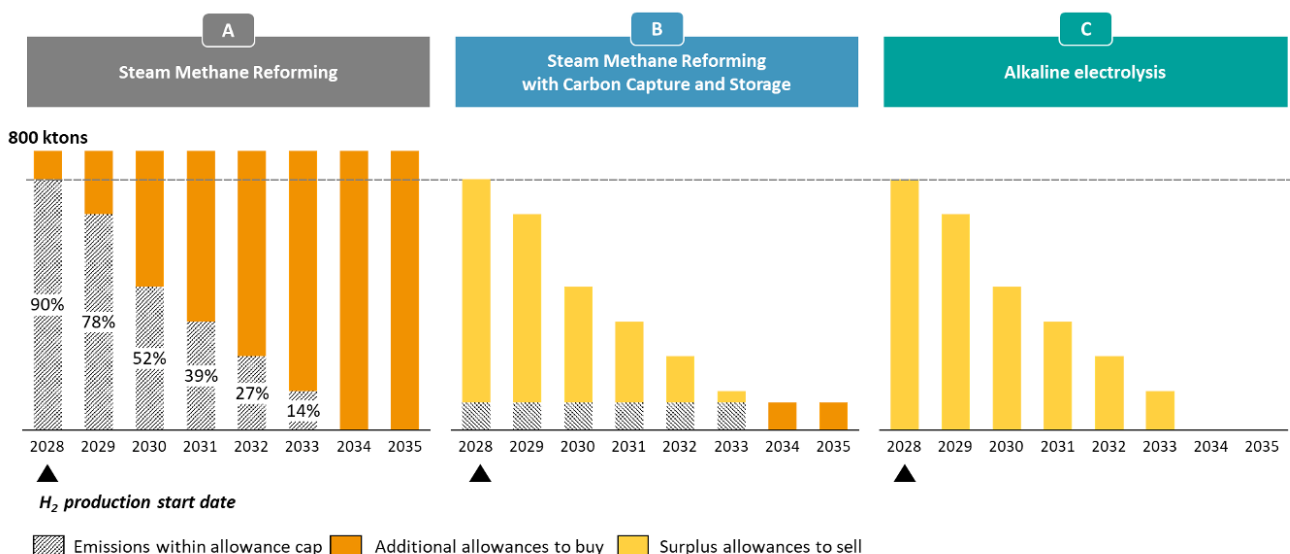

Figure 10 – Impact of CO₂ allowances in scenario A, B and C

2.8 Base case

Preliminary to sensitivity analysis to key parameters, LCOH computation is performed in the three scenarios under “base case” assumptions, i.e. NG price = 40 €/MWh, WACC = 8%, ETS price = 100€/ton of CO₂, offshore wind LCOE = 45 €/MWh, electrolyser capacity factor = 51%, electrolyser CAPEX = 800 €/kW (C1) or 1050 €/KW (C2).

This set of assumptions leads to the conclusion that H₂ production cost from SMR+ CCS technology (Scenario B) is close to the production cost from SMR without carbon capture system (Scenario A). They are both significantly dependent from natural gas prices (~60% of total LCOH at 40€/ MWh) but ETS system at 100€/ton of CO₂ seems to compensate for additional CCS CAPEX and OPEX.

On the other hand, H₂ production cost from alkaline electrolysis is evaluated to be 15% to 25% higher than SMR (Scenario A) and 10% to 20% higher than SMR+CCS (Scenario B).

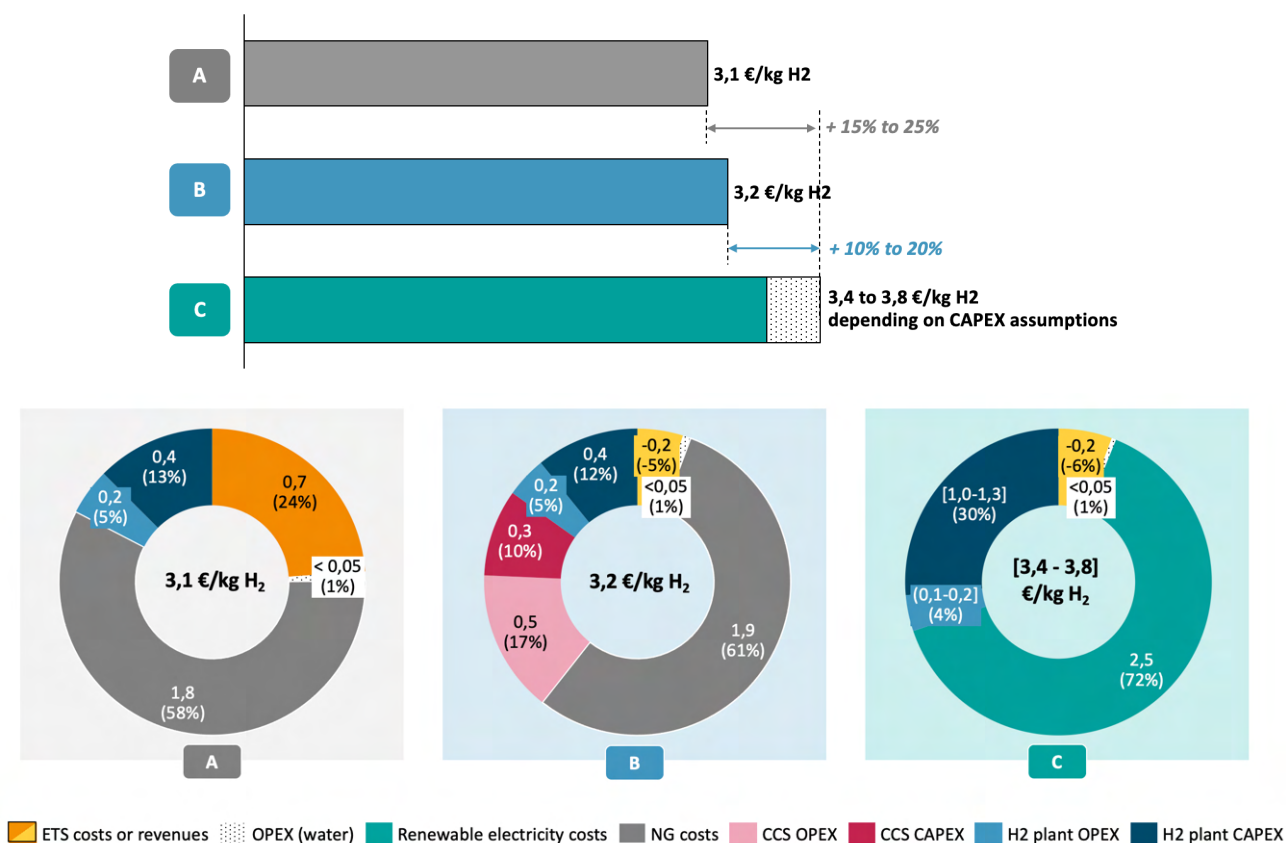

Figure 11 – Base case LCOH in scenario A, B and C
(NG price = 40 €/MWh, WACC = 8%, ETS price = 100€/ton of CO₂, offshore wind LCOE = 45 €/MWh, electrolyser capacity factor = 51%)

In scenario C, renewable electricity cost is the main contributor to the LCOH (72%) before electrolyser CAPEX (~30%). Nevertheless, R&D and industrial efforts to support electrolysis technology improvement and large-scale deployment will be a major driver of green hydrogen competitiveness.

3. Technological and industrial challenges of electrolyser CAPEX

The latest IEA Global Hydrogen review¹² shows that **current CAPEX required to install electrolysers are still higher than expected** in the Net Zero Emissions by 2050 scenario (1700 for ALK to 2000 \$/kW for PEM in 2023 compared to 900 to 1000 \$/kW forecasted in 2025) mainly due to increased materials and labour costs with significant discrepancies between manufacturing countries (basically cheaper in China than in Europe or North America).

However, **electrolysers CAPEX decrease is still expected based on economies of scale** (e.g., PEM electrolyzer gigafactory announced by Siemens and Air Liquide in 2023). Several technological and industrial challenges should be tackled in the very coming years to fulfill this ambition:

- Reduce the dependency to scarce materials especially platinum and cobalt for alkaline technology and teflon and iridium for PEM
- Increase the size of facilities to reduce the cost of balance of plant
- Automatization and standardization of electrolyzer manufacturing
- Secure ramp-up of the whole supply chain.

Given the current uncertainty about electrolysis CAPEX forecast by 2025, we consider **a range from 800 to 1050 €/kW as base case assumption**. Sensitivity analysis below shows the decrease in ALK CAPEX should reached 500 to 600 k€/KW to incite current H₂ users to switch – other parameters unchanged. The following parts of this report discuss the sensitivity to others key parameters.

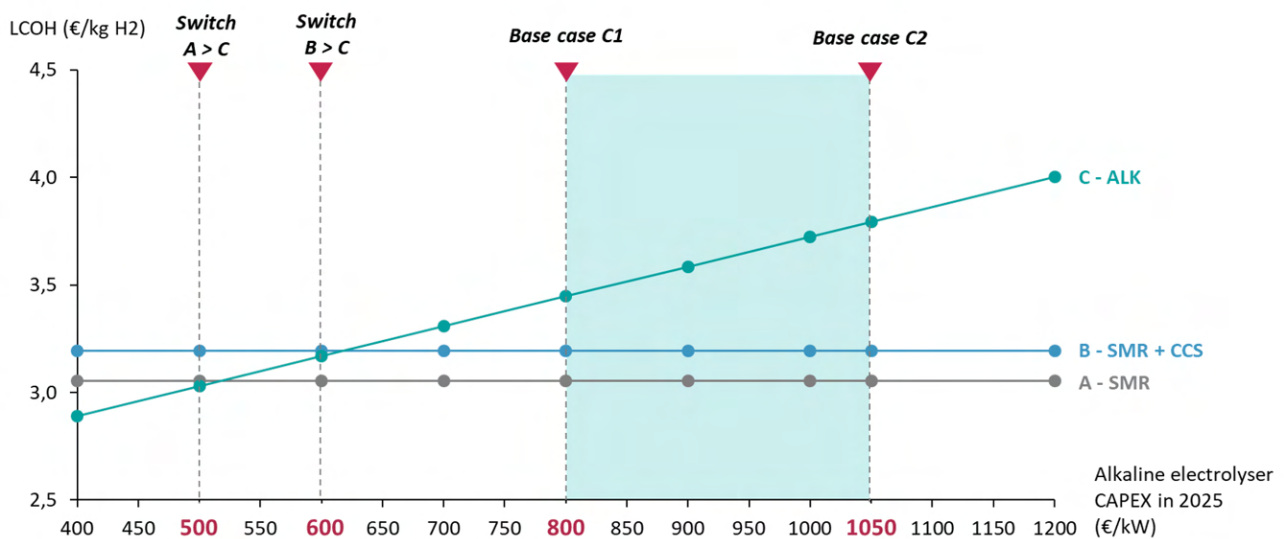

Figure 12 – LCOH sensitivity to electrolyser CAPEX
(WACC = 8%, ETS price = 100€/ton of CO₂, offshore wind LCOE = 45 €/MW,
capacity factor = 51%, NG price = 40 €/MWh)

4. Switching conditions: renewable electricity production and supply model

As demonstrated in Fig. 11, renewable electricity cost (LCOE) is a major driver of “green” hydrogen LCOH (~72% in the base case). Sensitivity analysis (Fig.13) demonstrates that the electricity supply cost should drop down to 30–40 €/MWh to reach the switching point in the Alkaline scenario.

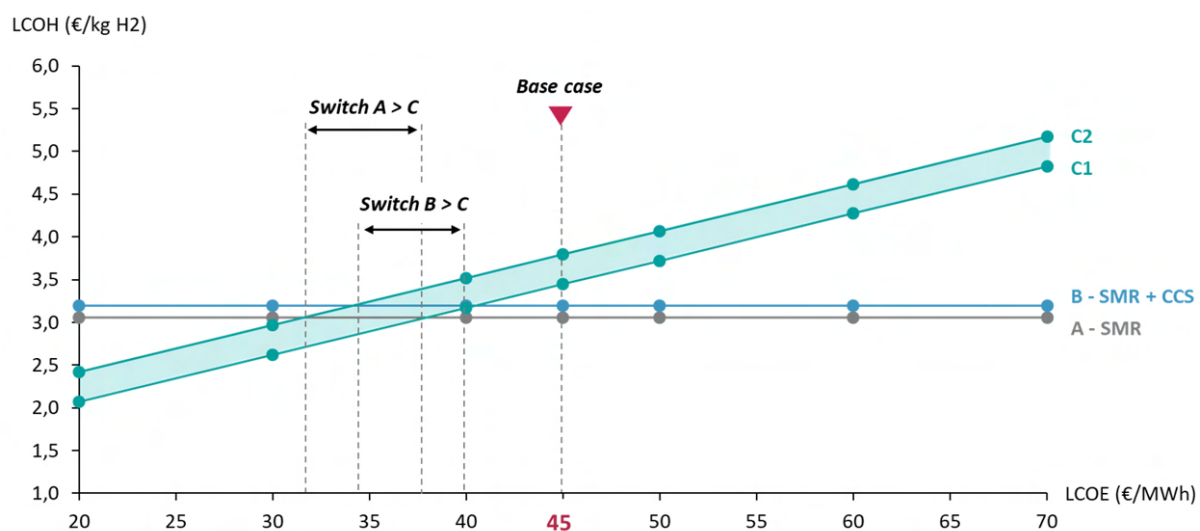

Figure 13 – LCOH sensitivity to electricity supply price
(NG price = 40 €/MWh, WACC = 8%, ETS price = 100€/ton of CO₂, capacity factor = 51%)

Dropping to that level with offshore wind seems to be more a target for 2035 – 2050. Currently, the average LCOE of newly commissioned offshore fixed bottom wind farms in Europe in 2021 was around 60€/MWh, with a 2030 target of 35 to 65€/MWh.

Though, it is possible to target a LCOE of 30€/MWh with an ad hoc combination of photovoltaic (PV) and onshore wind power, the cheapest renewable energy sources on the market. It would also increase the capacity factor of the electrolyzer and reduce its CAPEX. Being onsite, this would also benefit from a reduction of the connection cost. However, without adding storage capacity (that would dramatically increase the LCOE of the system), the capacity factor of the electrolyzer would also decrease in average and be more volatile. It would have two impacts:

- a direct one, as H₂ plant CAPEX per kg H₂ would increase (even though total CAPEX would stay significantly inferior to renewable electricity cost)
- an indirect one, as capacity factor volatility may lead to a higher cost over the ALK electrolyzer lifecycle (shorter lifetime, higher maintenance costs)

In 2023, onshore wind and PV projects have a higher LCOE than 30€/MWh driven by inflation on raw materials and shipping rates as well as an increase of cost of capital. As a comparison, the average EU retail industry electricity price was 116 €/MWh in 2021 (73 €/MWh in France) for large consumers.

Setting renewable power plants to directly power electrolyzers near existing refineries or ammonia production plants implies obvious operational challenges. Physical Power Purchase Agreement (PPA) is an alternative compliant with European definition of “renewable hydrogen” (even off site PPA under temporal and geographical conditions). From an economic perspective, this mechanism enables the hydrogen producer to build its investment plan with less exposure to electricity price volatility and thus reduces the financial risks of the project. From an industrial perspective, PPA (especially off site) widen the range of possibilities of renewable electricity plant locations and allow the structuration of the value chain around two specialist players: hydrogen producers and renewable electricity producers.

On the other hand, a 51% capacity factor of the alkaline electrolyzer has been assumed until now (Scenario C) as it is slightly superior to the capacity factor of the offshore wind plant thanks to overbuilding. Indeed, the Scenario C is set on the specific electricity supply model where the electricity plant is only and directly connected to the electrolyzer. SMR-based hydrogen production scenarios (Scenario A and B) assumed a 90% hydrogen plant capacity factor improving the economics of the LCOH at two levels: by reducing the investment period and/or by reducing the required capacity of the electrolyser to produce the same quantity of H₂.

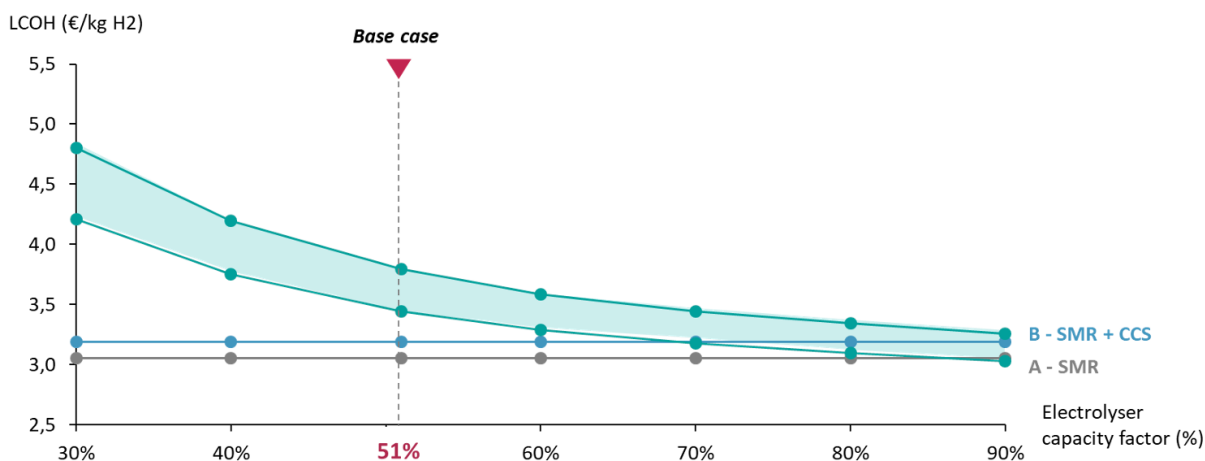

Electrolyser capacity	1710 MWe	1300	1000	850	720	630	560
Electrolyser lifetime	57 years	43	35	30	26	23	21

Figure 14 – LCOH sensitivity to electrolyser capacity factor
(NG price = 40 €/MWh, WACC = 8%, ETS price = 100€/ton of CO₂, offshore wind LCOE = 45 €/MWh)

The LCOH sensitivity analysis (Fig. 14) demonstrates that **the decrease of CAPEX due to a higher electrolyzer capacity factor is not sufficient to reach the LCOH of the SMR-based hydrogen production scenarios**. Besides, some of the electricity supply models that enable higher electrolyser capacity factors **might require additional CAPEX** (e.g. electricity storage).

An alternative to complementary storage is to supply all or part of the electricity from the grid. However, not all grid supply configurations are compliant with the current European “fully renewable” hydrogen definition (cf. EU Delegated Acts I and II adopted in February 2023²²). Indeed, **appropriate renewable energy capacities** (solar, wind or hydro) **must be added to the grid** (possibility off site and through physical Power Purchase Agreement) **and fulfill temporal and geographical correlation criteria**. Even if the hydrogen production plant is connected to a grid where the CO₂ emissions intensity is below 18 gCO₂e/MJ (in France for example), renewable PPA with temporal and geographical correlation must be made by the hydrogen producer²³.

In any case, choosing a **favorable location to set up the renewable power plant** (solar or wind) **is one competitiveness driver to consider** when maximizing the electrolyser capacity factor (i.e., solar panel in the south of Spain and wind farm in the North Sea). In 2022, the average capacity factor of the entire EU and UK wind farms were 24% for onshore and 36% for offshore¹². However, WindEurope¹⁴ and IEA¹⁶ market outlooks **forecast capacity factor for newly commissioned wind farm to be in the range of 30–35% (onshore) and of 40%–55% (offshore)** thanks to improvements in turbines technologies.

5. Switching conditions: natural gas and CO₂ prices

LCOH sensitivity analysis to natural gas price (Fig. 15 – all other parameters unchanged compared to base case) demonstrates that **high levels of natural gas prices (45 to 58 €/MWh) would be required over the investment period to close the gap with the cost of electrolysis-based hydrogen production (Scenario C) and then incite current users to switch from a strict economic standpoint**.

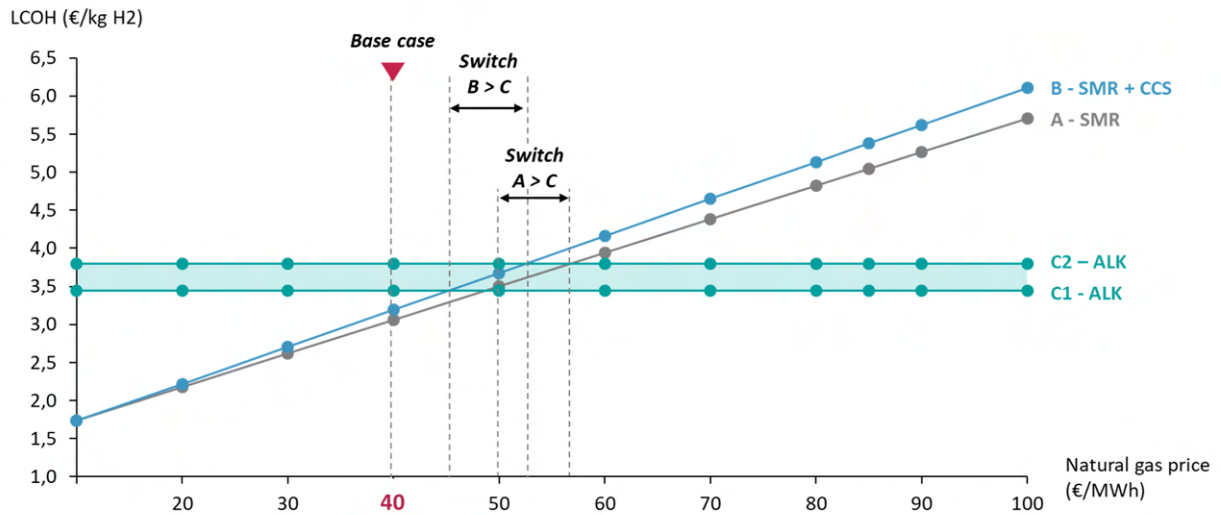

Figure 15 – LCOH sensitivity to natural gas price
(WACC = 8%, ETS price = 100€/ton of CO₂, offshore wind LCOE = 45 €/MWh, capacity factor = 51%)

LCOH sensitivity analysis to ETS market (Fig. 16 – all other parameters unchanged vs. base case) demonstrates that **CO₂ allowance prices should reach 150–180 €/kg CO₂** (x2 compared to S1 2023) to make electrolysis-based hydrogen production (Scenario C) LCOH competitive with SMR-based hydrogen (Scenario A).

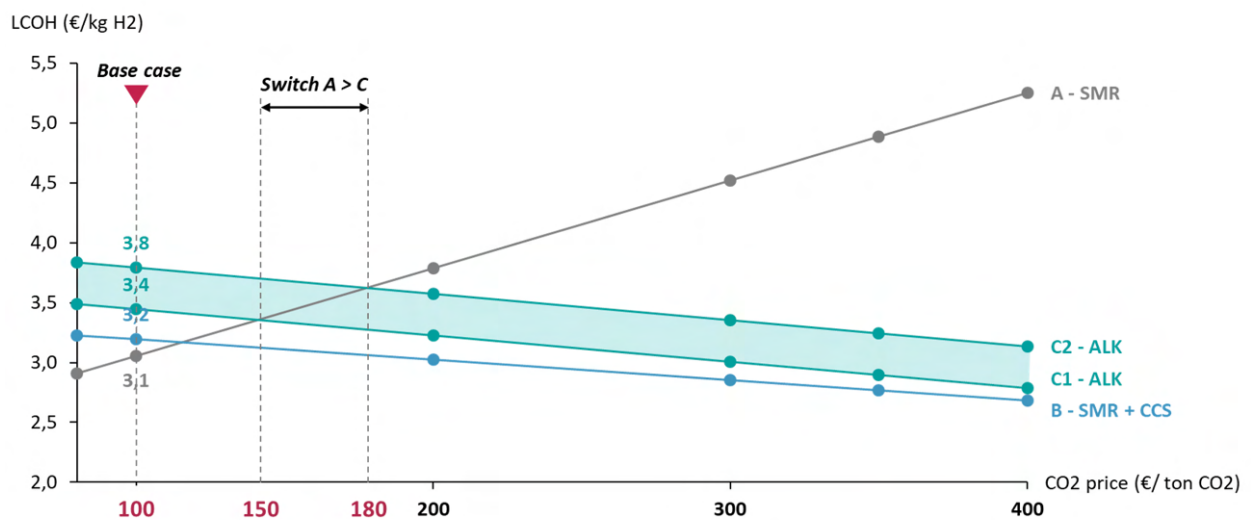

Figure 16 – LCOH sensitivity to CO₂ price (ETS)
(NG price = 40 €/MWh, WACC = 8%, offshore wind LCOE = 45 €/MWh, capacity factor = 51%)

Even though the CO₂ price has strongly increased since 2020 (from 20 €/ton of CO₂ to 100 €/ton of CO₂ in February 2023) and that **European Commission intends to stronger leverage carbon regulation** to support its decarbonation policy for the next decade (SEQE reforms, replacement of free CO₂ allowances by the Carbon Border Adjustment Mechanism CBAM²⁴), **current hydrogen users still have low visibility on CO₂ prices evolution to secure financially viable investment plans.**

In short, **producing “green” hydrogen (Scenario C) is competitive compared to “grey” or “blue” production scenarios (resp. Scenario A and B) under natural gas and CO₂ prices that have not been reached over a medium-term period.**

Current hydrogen users have few incentives to switch to electrolysis-based hydrogen production from a “pure” financial perspective, except their willingness to over-pay the hydrogen supply to fulfill their decarbonation ambitions. The European Hydrogen Bank (EHB) could although cover part of the extra costs associated with renewable hydrogen. On 31st of August the EC announced an auction of €800m to award a fixed premium subsidy of up to €4.5/kg to hydrogen producers to the extent of the budget limit. However, it is likely that only the applicants with the lowest bids will be granted the subsidy meaning that the auction won't make that big of an impact on renewable hydrogen prices²⁵.

In this context, another final mechanism to reduce LCOH in the Scenario C seem relevant to explore: setting up favorable financing conditions for low-carbon hydrogen projects to reduce the WACC.

6. Switching conditions: project financing

LCOH methodology (cf. chapter 2) relies on discounted costs and revenues over the plant lifetime. As a result, the discount rate (WACC) has a direct impact on the hydrogen plant investment decision. The WACC stands for the financing cost of the project directly linked to its level of risk. It depends on the cost of equity that represents the financial reward expected from project's shareholders and on the cost of debt that represents the level of risks estimated from creditors' standpoint.

Similar discount rates have been considered in the scenarios A, B and C so far (8% in base case). However, differentiated level of risks could have been considered between a SMR-based and an electrolysis-based hydrogen production project. Moreover, current attractiveness for “green” investments on financial markets could argue for lower WACC in Scenario C. Other factors could also influence the WACC such as financial strength of the enterprise that carries the project, the plant location, or the level of state guarantees on loans.

However, the sensitivity analysis for the discount rate (Fig. 17) demonstrates that the risk discrepancy between the SMR-based and the electrolysis-based scenarios should be out of standard to be the only switching driver.

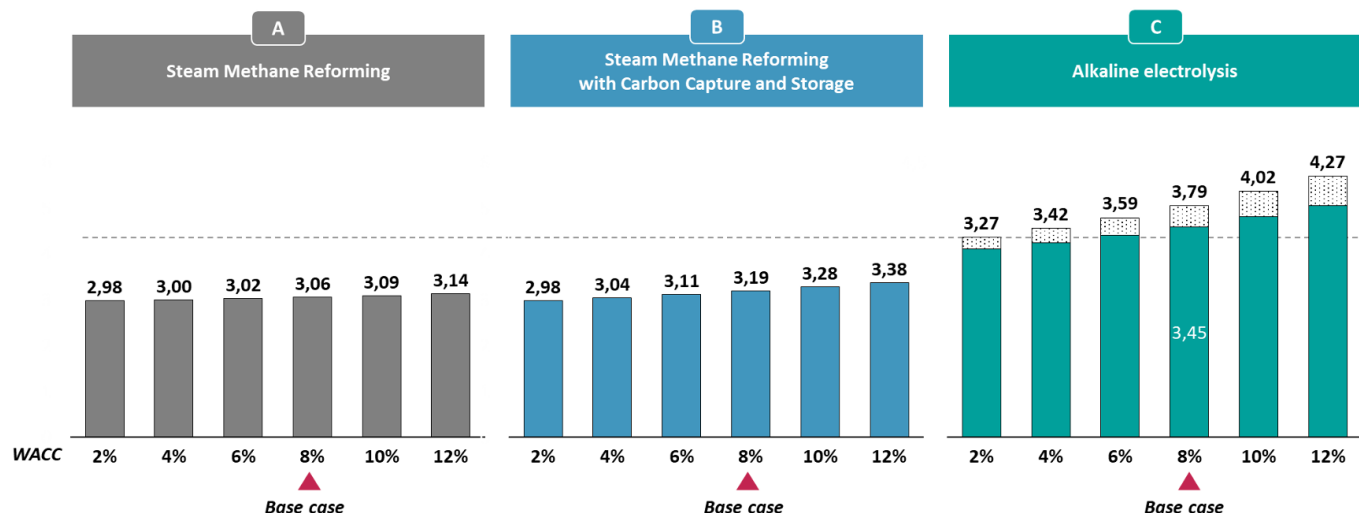

Figure 17 – LCOH sensitivity to discount rate (WACC)
 (NG price = 40 €/MWh, ETS price = 100€/t CO₂, LCOE = 45 €/MWh, capacity factor = 51%)

Overall, sensitivity analyses highlight that natural gas, carbon allowance and renewable electricity supply costs are the major economic factors driving the switch to low-carbon hydrogen production by 2030, even though parameters have been analyzed one-by-one in this study. The results suggest that **electrolysis LCOH reduction could be achieved through the complex optimization of all parameters** and adjust to the specific constraints and opportunities of the given industrial project (e.g. underground hydrogen storage to limit the effect of intermittent supply).

Besides, the three scenarios correspond to “pure” hydrogen production models but considering “hybrid” hydrogen production models as done by Jodry et al.³ where electrolyzers are combined with SMR allows a reduction of investment for flexibility needs (H₂ storage), a reduction of scenario C cost and a better utilization of existing infrastructures (SMR).

Finally, this report endorses the standpoint of a current H₂ industrial user. Therefore, the switching cost methodology and the associated sensitivity analysis rely on individual H₂ production schemes (LCOH). However, discussion about hydrogen production competitiveness could also be considered from a larger H₂ market perspective and then be assessed through the analysis of “marginal cost” (i.e. CAPEX already amortized). In this case, and in a future with possible importations from countries with a low hydrogen production cost, the situation where the H₂ producer has to buy electricity or gas to produce its hydrogen could lead to a point where it is not economically profitable to produce. Coupling the investment in renewable capacity production with that of an electrolyser allows to mitigate this risk.

CONCLUSION

The industrial switch to “green” hydrogen production technologies by the end of 2030 will not be triggered only by the economic rationale compared to Steam Methane Reforming technology.

Innovative business models to create additional revenue streams from hydrogen production are yet to be identified (e.g. compensation for available electricity capacity, electricity sale during peak hours...). The over-cost of “green” hydrogen could be addressed through the design of appropriate risk sharing model (in volume and price) between hydrogen producers, hydrogen consumers and governments to foster the “green hydrogen” projects ramp-up.

The main lever for renewable hydrogen LCOH reduction relies on Europe’s ability to produce sufficient and competitive renewable electricity by the end of 2030. To meet the volume objective, the industrial challenge of renewable energy production capacity ramp-up (wind and solar) would have to be addressed as well as the political prioritization of renewable energy uses between hydrogen production and European electricity mix decarbonization (cf. Part 2 of our Hydrogen series).

Evolutions of the European carbon allowance policy (ETS and CBAM) could facilitate the switch if it results in a significant increase of carbon market price over the next decade (at least 200 €/ ton CO₂).

In this context, low-carbon H₂ industrial producers would face strategic issues in terms of value chain positioning to secure a viable business model: should they vertically integrate renewable electricity production capabilities? Would H₂ industrial production specialists emerge from electricity pure-players, gas pure-players or from ad-hoc joint-ventures?

BIBLIOGRAPHY

1. Clean Hydrogen Monitor 2022. Hydrogen Europe (2023) <https://hydrogeneurope.eu/clean-hydrogen-monitor-2022/>.
2. B. Shirizadeh, P. Quirion. Long-term optimization of the hydrogen-electricity nexus in France: Green, blue, or pink hydrogen? Energy Policy, Volume 181, 2023, ISSN 0301-4215. <https://doi.org/10.1016/j.enpol.2023.113702>.
3. A. Jodry, R. Girard, P. Henrique, A. Nóbrega, R. Molinier, M.D. El Alaoui Faris. Industrial hydrogen hub planning and operation with multi-scale optimisation. Journal of Cleaner Production, Volume 426, 2023, ISSN 0959-6526. <https://doi.org/10.1016/j.jclepro.2023.138750>.
4. The Future of Hydrogen – Analysis. IEA. (2019) <https://www.iea.org/reports/the-future-of-hydrogen>
5. CCUS in clean energy transitions – Energy Technology Perspectives. IEA (2020). <https://www.iea.org/reports/ccus-in-clean-energy-transitions>
6. Techno-Economic Evaluation of SMR Based Standalone (Merchant) Hydrogen Plant with CCS. IEAGHG Technical Report 2017-02. https://ieaghg.org/exco_docs/2017-02.pdf
7. EU Delegated Acts on Renewable Hydrogen. European Commission (2023). https://ec.europa.eu/commission/presscorner/detail/en/qanda_23_595.
8. From, T. N. et al. Electrified steam methane reforming of biogas for sustainable syngas manufacturing and next-generation of plant design: A pilot plant study. Chemical Engineering Journal 479, 147205 (2024). <https://doi.org/10.1016/j.cej.2023.147209>
9. ETP Clean Energy Technology Guide – Data Tools. IEA (2023) <https://www.iea.org/data-and-statistics/data-tools/etp-clean-energy-technology-guide>.
10. A.O. Oni, K. Anaya, T. Giwa, G. Di Lullo, A. Kumar. Comparative assessment of blue hydrogen from steam methane reforming, autothermal reforming, and natural gas decomposition technologies for natural gas-producing regions. Energy Conversion and Management, Volume 254, 2022, ISSN 0196-8904, <https://doi.org/10.1016/j.enconman.2022.115245>.
11. Ørsted and Yara seek to develop groundbreaking green ammonia project in the Netherlands | Yara International. Yara None (2023). <https://www.yara.com/corporate-releases/orsted-and-yara-seek-to-develop-groundbreaking-green-ammonia-project-in-the-netherlands/>
12. Global Hydrogen Review 2022 – Analysis. IEA (2022). <https://www.iea.org/reports/global-hydrogen-review-2022>.
13. Global Hydrogen Review 2023 – Analysis. IEA (2023). <https://www.iea.org/reports/global-hydrogen-review-2023>

BIBLIOGRAPHY

14. Wind energy in Europe: 2022 Statistics and the outlook for 2023–2027. WindEurope (2023). <https://windeurope.org/intelligence-platform/product/wind-energy-in-europe-2022-statistics-and-the-outlook-for-2023-2027>.
15. Green hydrogen cost reduction: Scaling up electrolyzers to meet the 1.5C climate goal. IEA (2020). https://www.irena.org/-/media/Files/IRENA/Agency/Publication/2020/Dec/IRENA_Green_hydrogen_cost_2020.pdf
16. Offshore Wind Outlook 2019: World Energy Outlook Special Report. IEA (2019). <https://www.iea.org/reports/offshore-wind-outlook-2019>
17. Renewable power generation costs in 2021. IRENA (2021). <https://www.irena.org/publications/2022/Jul/Renewable-Power-Generation-Costs-in-2021>
18. D. Snieckus. First ever gigawatt-scale electrolyser order confirmed for offshore wind-powered green hydrogen project. Recharge | Latest renewable energy news (2023). <https://www.rechargenews.com/energy-transition/first-ever-gigawatt-scale-electrolyser-order-confirmed-for-offshore-wind-powered-green-hydrogen-project/2-1-1220683>.
19. HyDeal España (2023). <https://www.hydeal.com/copie-de-hydeal-ambition>.
20. EU Emissions Trading System (ETS) data viewer. European Environment Agency (2023). <https://www.eea.europa.eu/data-and-maps/dashboards/emissions-trading-viewer-1>.
21. J. Marullaz. 2023 State of the EU ETS Report. ERCST (2023). <https://ercst.org/2023-state-of-the-eu-ets-report/>
22. Renewable hydrogen production: new rules formally adopted. European Commission (2023). https://energy.ec.europa.eu/news/renewable-hydrogen-production-new-rules-formally-adopted-2023-06-20_en.
23. G. Erbach, S. Svensson. EU rules for renewable hydrogen Delegated regulations on a methodology for renewable fuels of non-biological origin. European Parliamentary Research Service (2023). [https://www.europarl.europa.eu/RegData/etudes/BRIE/2023/747085/EPRS_BRI\(2023\)747085_EN.pdf](https://www.europarl.europa.eu/RegData/etudes/BRIE/2023/747085/EPRS_BRI(2023)747085_EN.pdf)
24. Carbon Border Adjustment Mechanism. European Commission (2021). https://ec.europa.eu/commission/presscorner/detail/en/qanda_21_3661.
25. Upcoming EU Hydrogen Bank pilot auction: European Commission publishes Terms & Conditions. European Commission (2023). https://climate.ec.europa.eu/news-your-voice/news/upcoming-eu-hydrogen-bank-pilot-auction-european-commission-publishes-terms-conditions-2023-08-30_en.



AUTHORS

Archery Strategy
Consulting

Julien Lamarque-Lacoste

Manon de la Motte Saint
Pierre

Théo Mange

Zenon Research & Mines
Paris PSL

Robin Girard

Thomas Boigontier

ACKNOWLEDGEMENTS

The authors gratefully
acknowledge the review and
useful suggestions from:

Cédric Philibert
IEA

Pedro Affonso Nobrega
Mines Paris, PERSEE

This note should be cited as:

Zenon Research, Archery Strategy Consulting (2023),
Low-carbon hydrogen production in the European Union:
what economic conditions are required to switch to low-
carbon hydrogen in 2030?

ARCHERY
STRATEGY CONSULTING

www.zenon.ngo
www.archeryconsulting.com