

103rd Annual Meeting of Transportation Research Board
ACP50 – Traffic Flow Theory and Characteristics Committee
3002 – Network Modeling and Control

A Bi-level Method for Link Speed Estimation Based on Macroscopic Fundamental Diagram Using Deep Learning

Zhixiong JIN^{1,2}, Dimitrio Tsitsokas², Nikolas Geroliminis² and Ludovic Leclercq¹

zhixiong.jin@univ-eiffel.fr

¹ Univ.Gustave Eiffel, ENTPE, LICIT-ECO7, Lyon, France

² École Polytechnique Fédérale de Lausanne (EPFL), Urban Transport Systems Laboratory, Switzerland

09.01.2023



This project has received funding from the European Union's Horizon 2020 research and innovation program under Grant Agreement no. 953783 (DIT4TraM).



Graduate School of Civil, Environmental and Urban Engineering

Introduction

Background

- **Urban Traffic Challenges:** Rapid urbanization and increasing vehicular usage exacerbate traffic congestion in cities.
- **Large-Scale Optimization:** Macroscopic Fundamental Diagram (MFD)^[1,2] offers a holistic perspective and efficient approach for optimizing traffic across urban networks.
 - Fast for large-scale optimization ^[3,4]

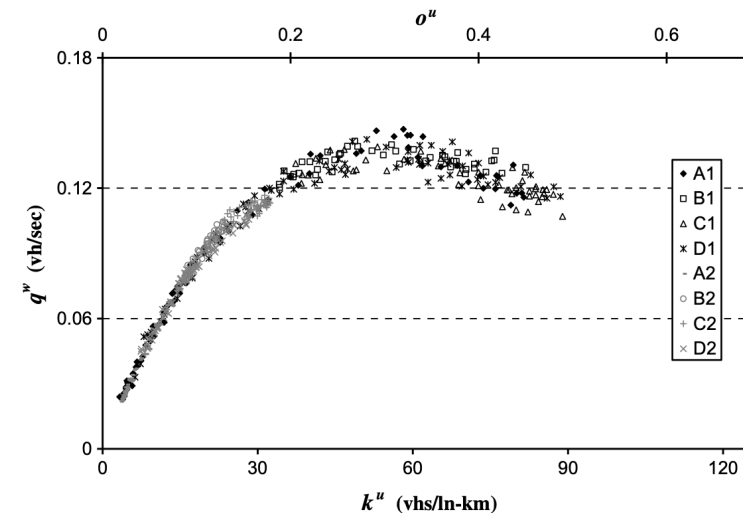

Introduction

Limitation of MFD-based simulator

- **Aggregated Data:** MFD uses aggregated traffic data, which ignores the unique conditions of individual road links
- **Limited Spatial Diversity**
 - Can't reflect the spatial diversity of road networks
 - A comprehensive traffic management approach may require integrating MFDs with more granular levels.

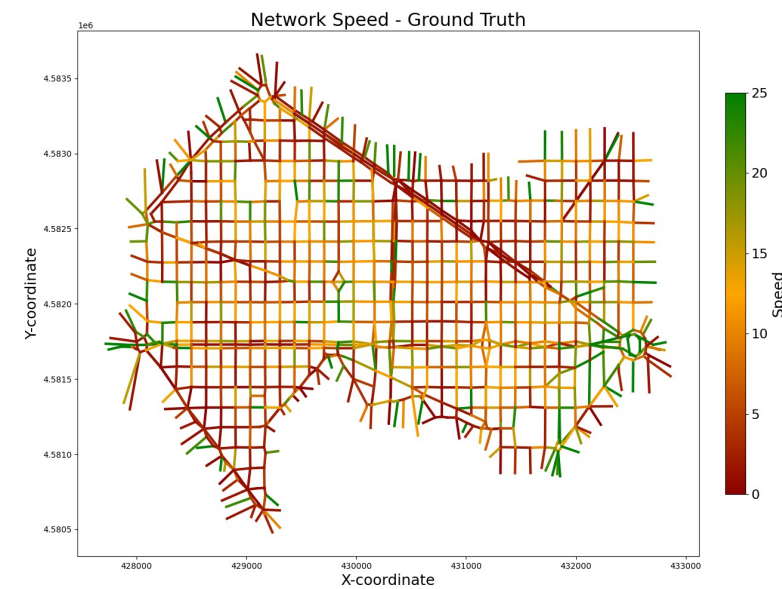
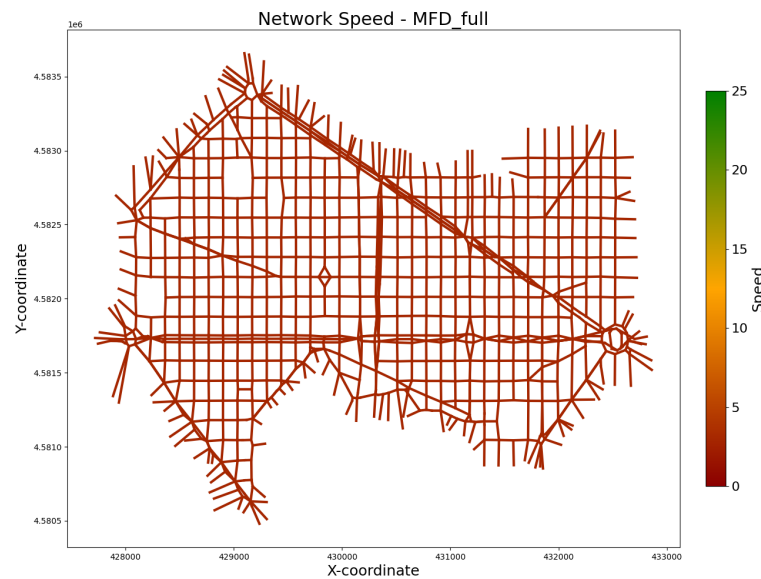

Problem Definition

Research Objective

- **Objective:** Estimate the speed of each link in the road network for the MFD-based simulator
 - Local correction factor (f_{LCF})
 - Input:
 - ✓ Spatial characteristic of each link ($S_{spatial}$)
 - ✓ Average speed information of network from speed MFD (V_{S-MFD})
 - Output:
 - Speed of each link in the network (V_{link})
 - $V_{link} = f_{LCF}(S_{spatial} + V_{S-MFD})$



Methodology

Deep learning approach

- Deep learning approach in speed estimation
 - Powerful techniques to solve complex non-linear problem
 - Popular approach in speed prediction^[5,6,7,8]
 - Multilayer-Perceptron (MLP), Recurrent Neural Network (RNN), Graph Neural Network (GNN) ...
 - Leverage information from aggregated data (MFD) and spatial characteristics to estimate the speed of the network.

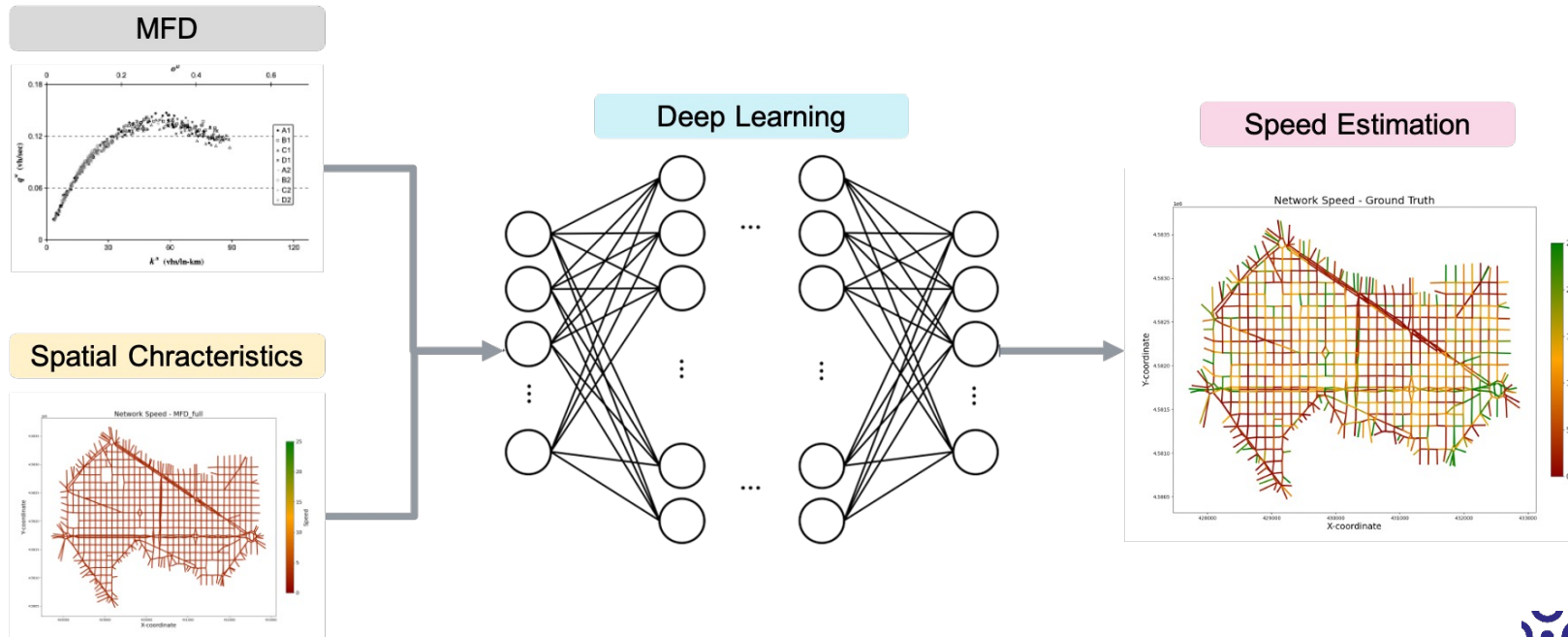

Methodology

Model framework – STGNN (Spatio-Temporal Graph Neural Network)

- Use three deep neural network models to estimate the speed of each link
 - Spatial Embedding: Graph Attention network (GAT)
 - Temporal Embedding: Gated Recurrent Unit (GRU)
 - Speed Estimator: Multi-layer Perceptrons (MLP)

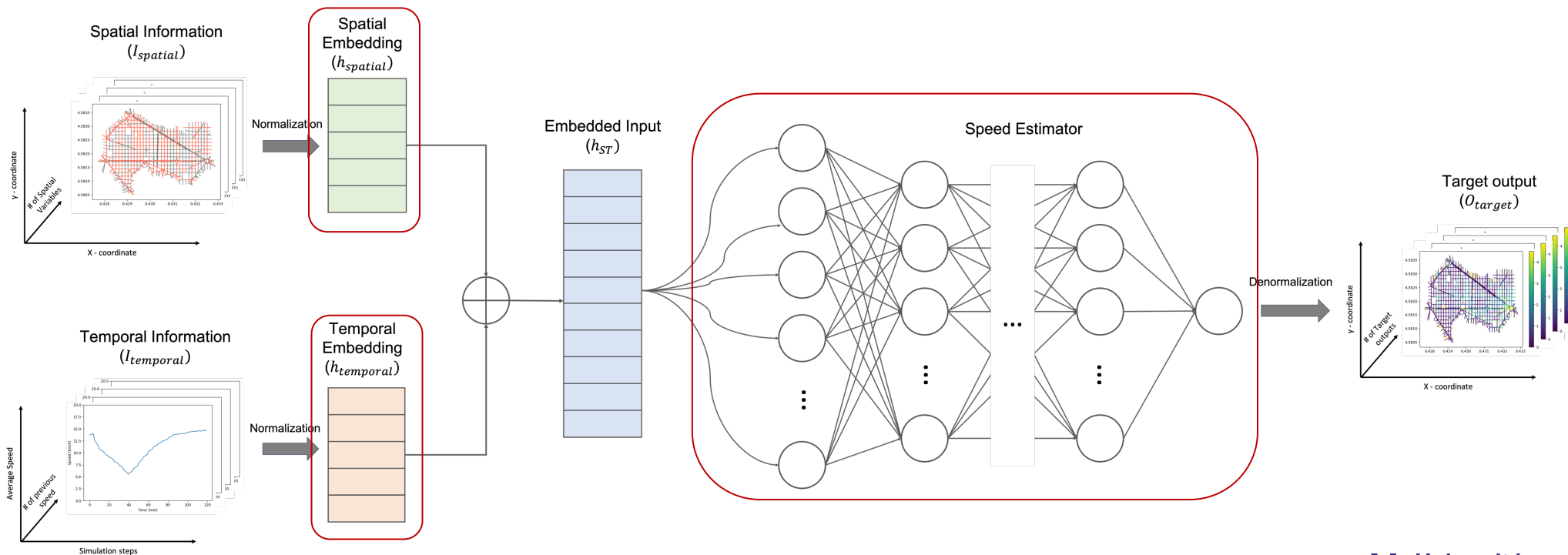

Methodology

Description of Spatial and Temporal Embedding

- GAT: dynamically weigh the influence of different nodes in a network
 - Spatial features: (10 features)
 - ✓ Length of link, number of lanes, number of upstream/downstream links, number of virtual links in upstream/downstream, ratio of lane reduction, number of bus lanes at upstream/downstream, label of partitioned sub-network
- GRU: efficiently captures temporal dependencies by using gates to regulate the flow of information
 - Average speed of speed MFD
 - Temporal features: average speed of each sub-network at previous time steps (4 steps)

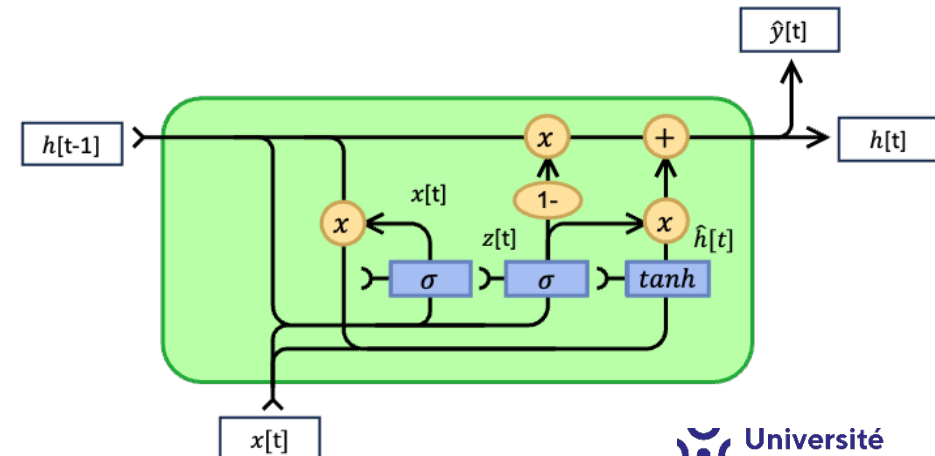
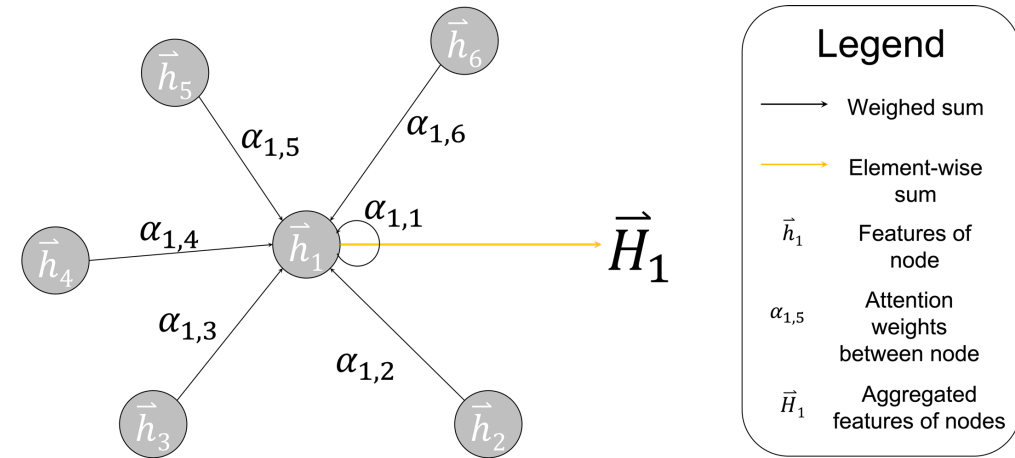

Performance Evaluation

Target area – Barcelona Network

- Number of links: 1570
- Number of nodes: 933
- Number of lanes: 1 to 5
- Number of dedicated bus lanes: 818
 - At least 2 lanes included in the link
 - Adjust the existence of bus lanes to change the road configuration
- Number of signalized junctions: 565

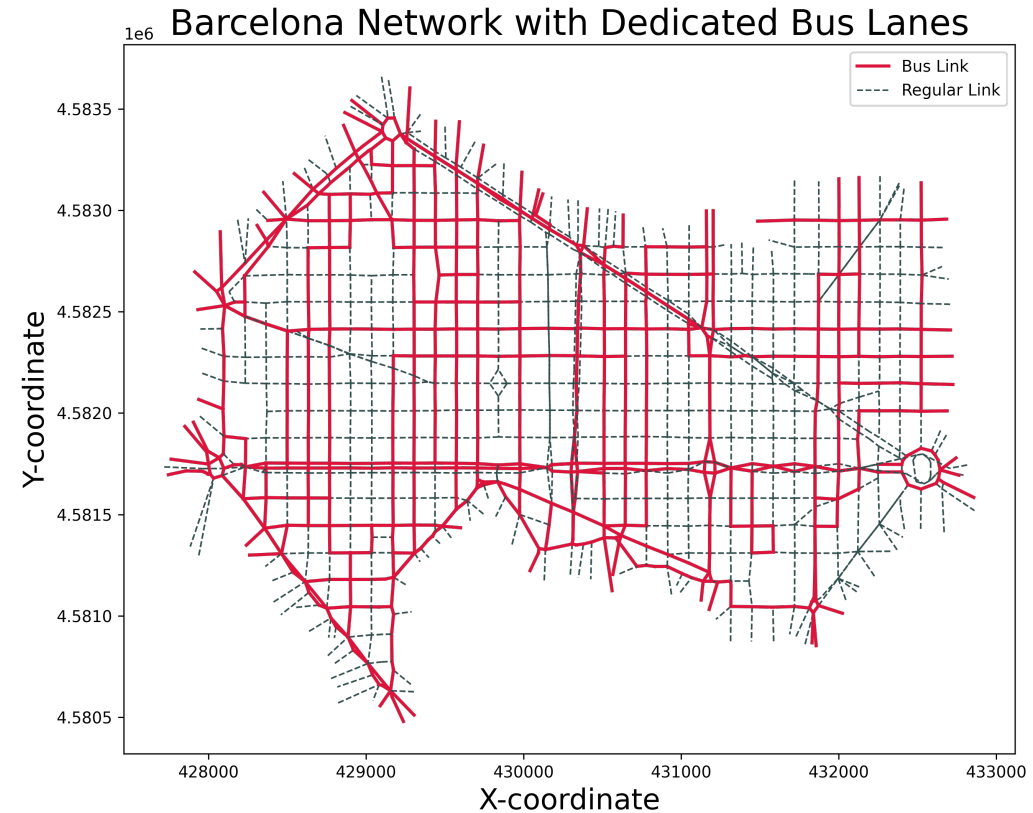

Performance Evaluation

Network partitioning

Link coordination
(X_{link}, Y_{link})

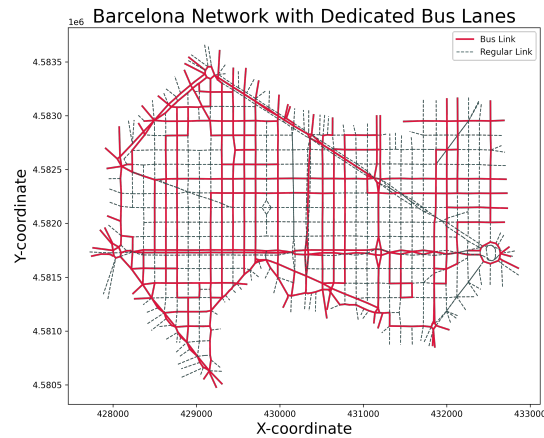

Average speed
at maximum
production
(V_{avg})

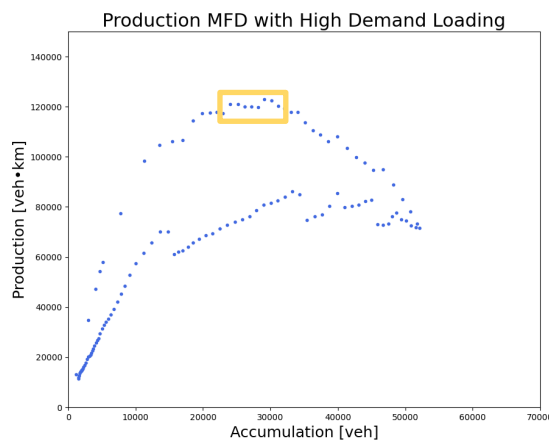

Clustering^[9,10]

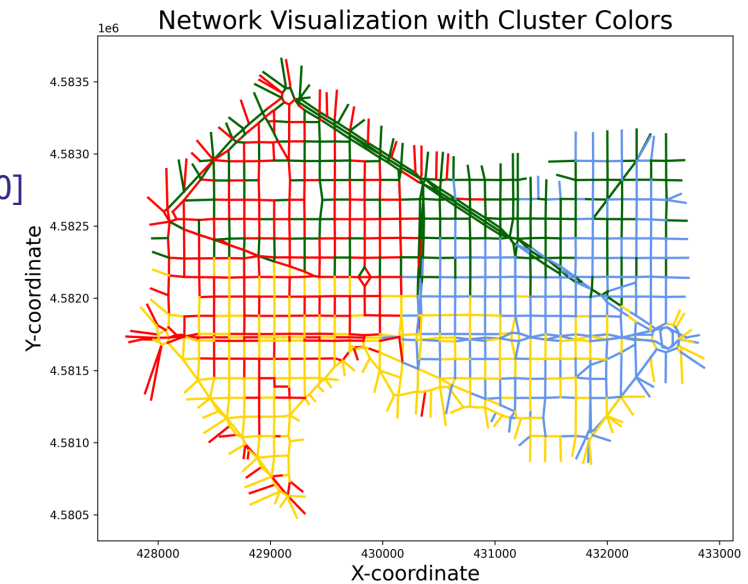

Performance Evaluation

Data generation - Simulation

- Macroscopic, Queue-based Store-and-Forward (SaF) paradigm with enhanced structural properties derived by S-Model^[11]
- Various scenario
 - Different OD, demand, road configuration
 - 6h simulation, 120 time steps, 3min aggregated/step
 - **Estimate the speed of the link at each time step**
- Three types of demand cases
 - Training: Medium demand, general scenarios (50 scenarios, 6000 steps)
 - Testing: 1. Normal: Medium demand, 2. Extreme: low and high demand (12 scenarios, 1440 steps)

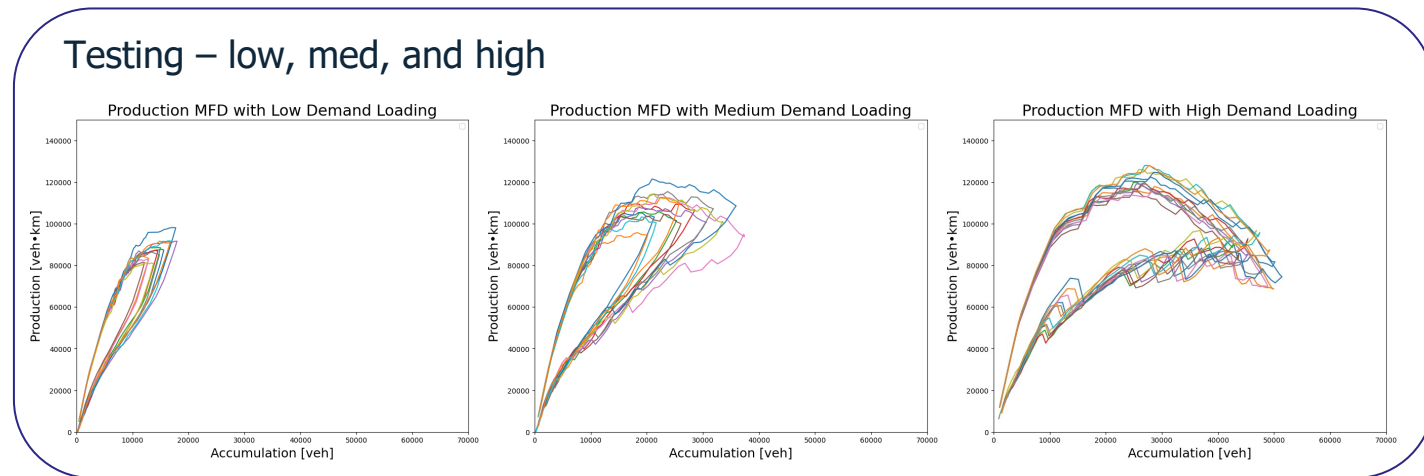
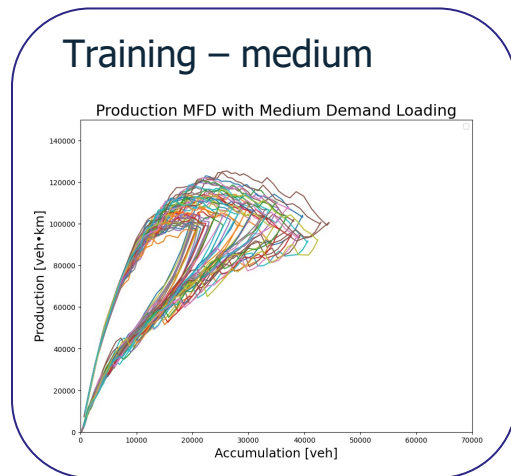

Performance Evaluation

Data generation – Baseline models & Metrics

- Baseline models
 - Linear Regression, XGBoost,
 - Deep Neural Network (DNN), Graph Neural Network (GNN), Spatio-Temporal Deep Neural Network (ST-DNN), and Spatio-Temporal Graph Neural Network (ST-GNN)
- Evaluation metrics
 - **Mean Absolute Error (MAE)**, Mean Squared Error (MSE) and Root Mean Squared Error (RMSE)
- Output format
 - Ratio: Actual speed / average speed
 - Diff: Actual speed - average speed
 - Speed: Actual speed



Performance Evaluation

Result (1) – Test in normal scenario (median demand loading)

- Deep learning-based model → high performance
 - STGNN: 1.3131 km/h error
- Temporal information → improve performance
 - DNN vs STDNN, GNN vs STGNN
- Different output → small performance differences

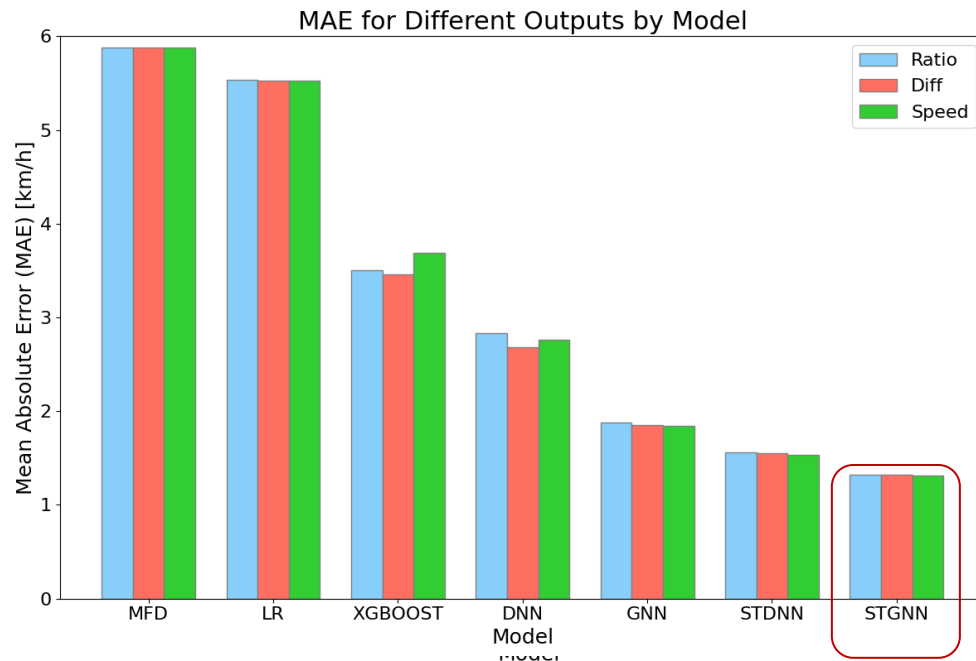

Tab 1: Performance evaluation with medium demand [km/h]

| Model | Output | MAE | MSE | Error Mean | Error STD |
|---------|--------------|---------------|---------------|----------------|---------------|
| MFD | - | 5.8808 | 48.7415 | 0.0000 | 6.9815 |
| LR | Ratio | 5.5348 | 44.1518 | 0.0119 | 6.6447 |
| | Diff | 5.5225 | 43.8645 | 0.0058 | 6.6230 |
| | Speed | 5.5226 | 43.8645 | 0.0066 | 6.6230 |
| XGBOOST | Ratio | 3.5032 | 25.0235 | 0.0934 | 5.0015 |
| | Diff | 3.4632 | 24.7820 | 0.0661 | 4.9777 |
| | Speed | 3.6887 | 27.2620 | 0.1501 | 5.2191 |
| DNN | Ratio | 2.8330 | 20.7619 | 0.2742 | 4.5483 |
| | Diff | 2.6806 | 19.7136 | 0.1808 | 4.4363 |
| | Speed | 2.7575 | 20.5260 | 0.2339 | 4.5245 |
| GNN | Ratio | 1.8784 | 12.8576 | 0.0471 | 3.5854 |
| | Diff | 1.8540 | 12.6814 | 0.0673 | 3.5605 |
| | Speed | 1.8466 | 12.8286 | 0.0954 | 3.5804 |
| STDNN | Ratio | 1.5591 | 8.8222 | 0.0806 | 2.9691 |
| | Diff | 1.5492 | 8.8086 | 0.0628 | 2.9587 |
| | Speed | 1.5338 | 8.7474 | 0.0538 | 2.9571 |
| STGNN | Ratio | 1.3250 | 7.6582 | 0.0649 | 2.7683 |
| | Diff | 1.3251 | 7.3392 | 0.0649 | 2.7083 |
| | Speed | 1.3131 | 7.3091 | -0.0124 | 2.7073 |

Performance Evaluation

Result (2) – Effect of network partitioning (median demand loading)

- Add network partitioned information → improve overall performances
 - STGNN: 1.0404 km/h error → 0.3km/h improvement
 - Efficient in model performance

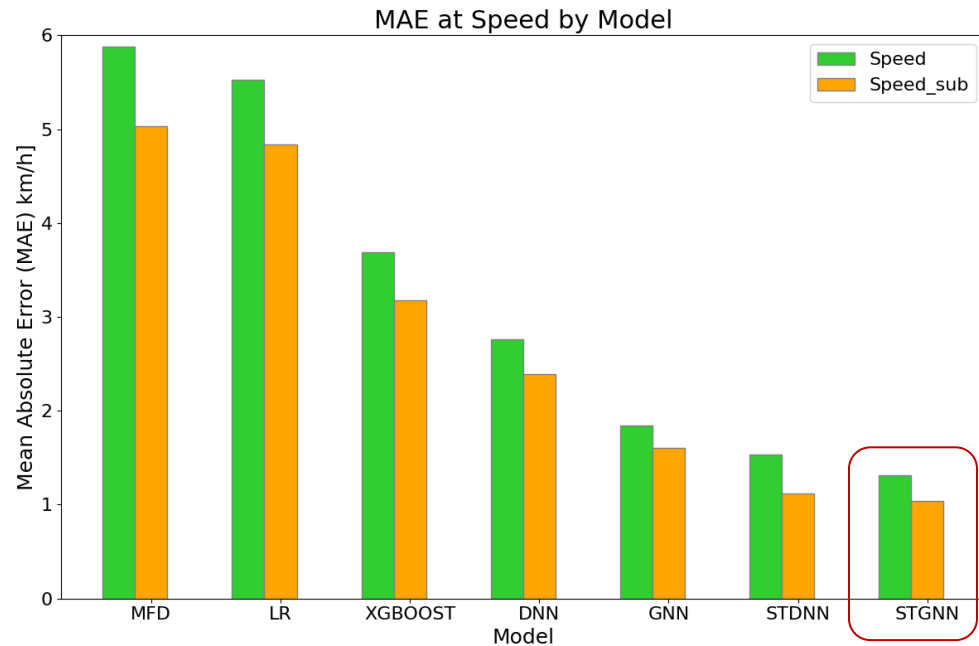

Tab 2: Performance evaluation with medium demand [km/h]

| Type | Model | MAE | Improve | Error Mean | Error STD |
|--------------|------------------|---------------|---------------|----------------|---------------|
| Origin | MFD | 5.8808 | - | 0.0000 | 6.9815 |
| Origin + sub | MFD_sub | 5.0319 | 14.44% | 0.0000 | 6.1299 |
| Origin | LR | 5.5226 | - | 0.0066 | 6.6230 |
| Origin + sub | LR_sub | 4.8373 | 12.41% | 0.0048 | 5.9290 |
| Origin | XGBOOST | 3.6887 | - | 0.1501 | 5.2191 |
| Origin + sub | XGBOOST_sub | 3.1742 | 13.94% | 0.1341 | 4.7334 |
| Origin | DNN | 2.7575 | - | 0.2339 | 4.5245 |
| Origin + sub | DNN_sub | 2.3885 | 13.40% | 0.1513 | 4.1213 |
| Origin | GNN | 1.8466 | - | 0.0954 | 3.5804 |
| Origin + sub | GNN_sub | 1.6075 | 12.95% | 0.0895 | 3.1966 |
| Origin | STDNN | 1.5338 | - | 0.0538 | 2.9571 |
| Origin + sub | STDNN_sub | 1.1184 | 27.08% | 0.0321 | 2.3836 |
| Origin | STGNN | 1.3131 | - | -0.0124 | 2.7073 |
| Origin + sub | STGNN_sub | 1.0404 | 23.84% | -0.0265 | 2.3160 |

Performance Evaluation

Result (3) – Test in extreme scenarios (low and high demand loading)

- Performance slightly decreases
 - STGNN - Low: 1.3206 km/h error, high: 1.4678 km/h error
 - Robustness of model in different scenarios (demand + OD distribution+ road configuration)

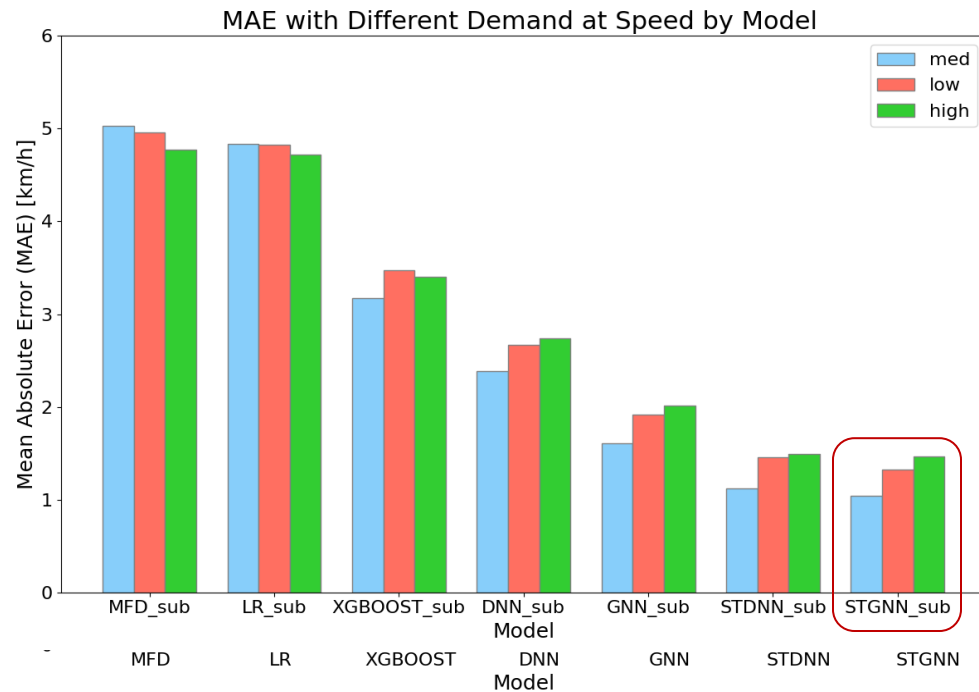

Tab 3: Performance evaluation with various demand [km/h]

| Model | Demand | MAE | Improve | Error Mean | Error STD |
|------------------|-------------|---------------|----------------|----------------|---------------|
| MFD_sub | med | 5.0319 | - | 0.0000 | 6.1299 |
| | low | 5.5052 | -9.41% | 0.0000 | 6.7059 |
| | high | 5.8304 | -15.87% | 0.0000 | 6.9921 |
| LR_sub | med | 4.8373 | - | 0.0048 | 5.9290 |
| | low | 4.8244 | -0.27% | 0.1385 | 5.9418 |
| | high | 4.7180 | -2.47% | -0.1045 | 5.8952 |
| XGBOOST_sub | med | 3.1742 | - | 0.1341 | 4.7334 |
| | low | 3.4769 | -9.54% | 0.0459 | 5.1713 |
| | high | 3.3997 | -7.10% | 0.0894 | 5.0446 |
| DNN_sub | med | 2.3885 | - | 0.1513 | 4.1213 |
| | low | 2.6696 | -11.77% | 0.1226 | 4.6639 |
| | high | 2.7350 | -14.51% | 0.0771 | 4.5994 |
| GNN_sub | med | 1.6075 | - | 0.0895 | 3.1966 |
| | low | 1.9137 | -19.05% | 0.0833 | 3.8190 |
| | high | 2.0134 | -25.25% | 0.1276 | 3.8436 |
| STDNN_sub | med | 1.1184 | - | 0.0321 | 2.3836 |
| | low | 1.4564 | -30.22% | 0.0625 | 3.1447 |
| | high | 1.4951 | -33.68% | -0.0689 | 3.1206 |
| STGNN_sub | med | 1.0404 | - | -0.0265 | 2.3160 |
| | low | 1.3206 | -26.93% | 0.1021 | 2.6330 |
| | high | 1.4678 | -41.08% | -0.0034 | 2.9863 |

Performance Evaluation

Result (4) – Speed Visualization

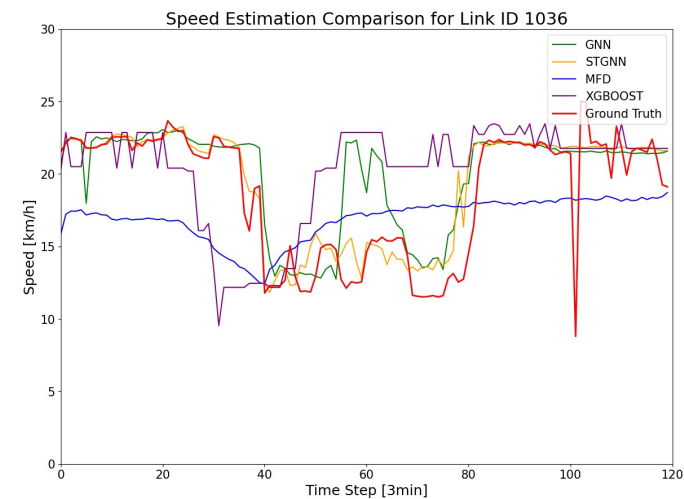
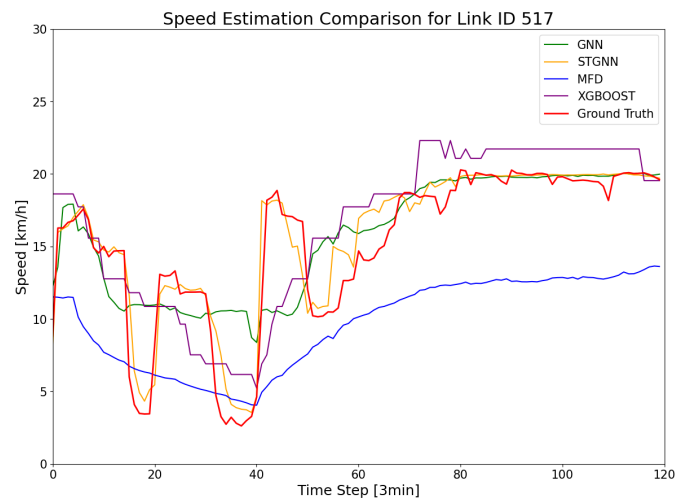
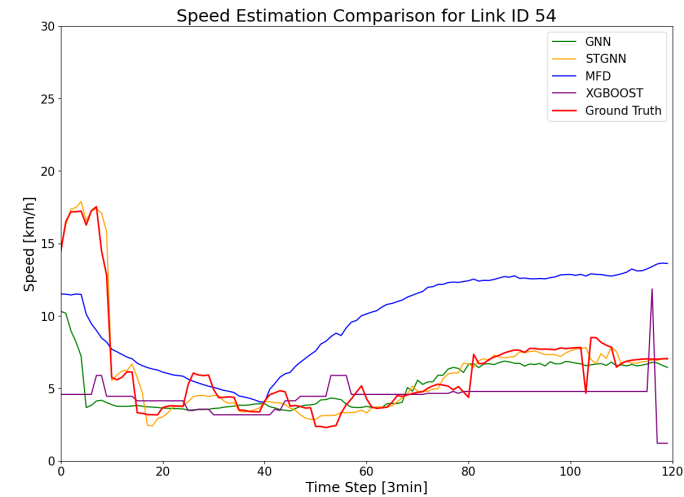
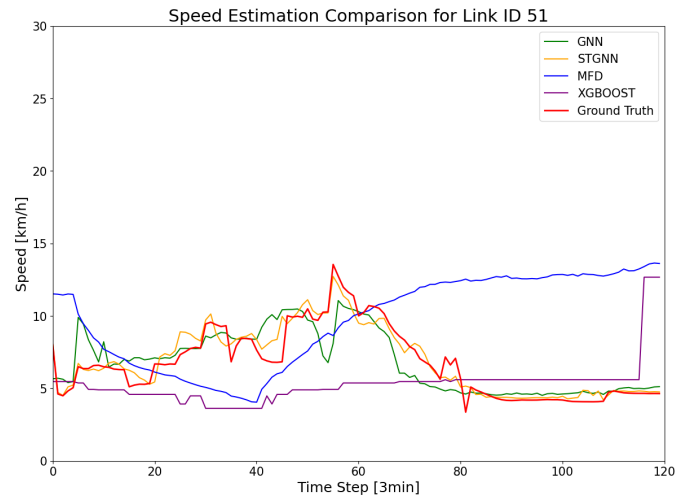

Performance Evaluation

Result (4) – Speed Visualization

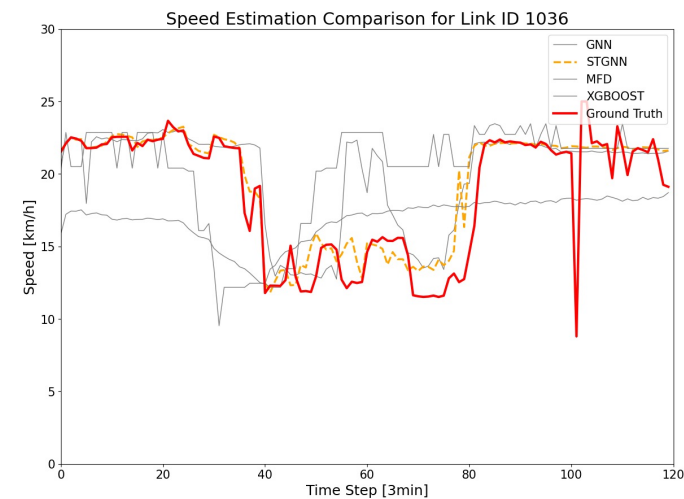
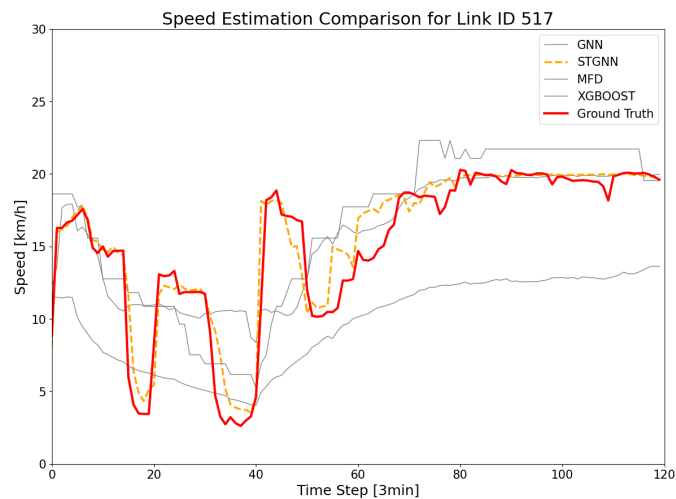
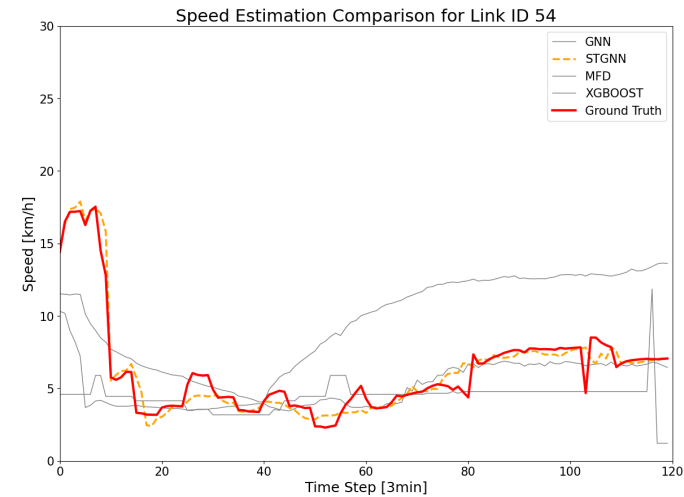
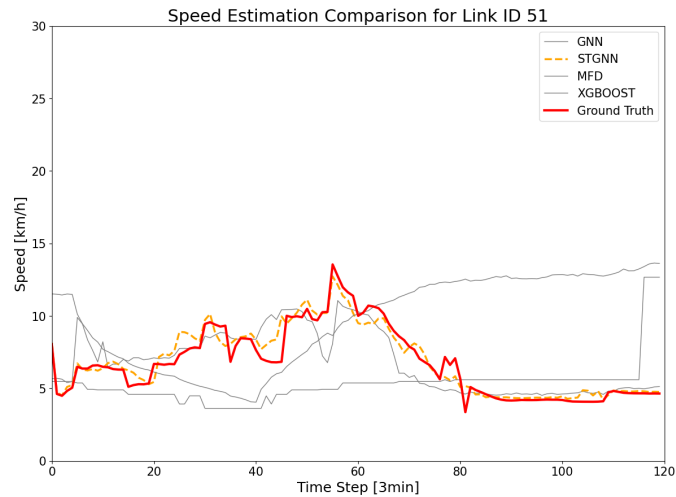

Performance Evaluation

Result (5) – Network Visualization

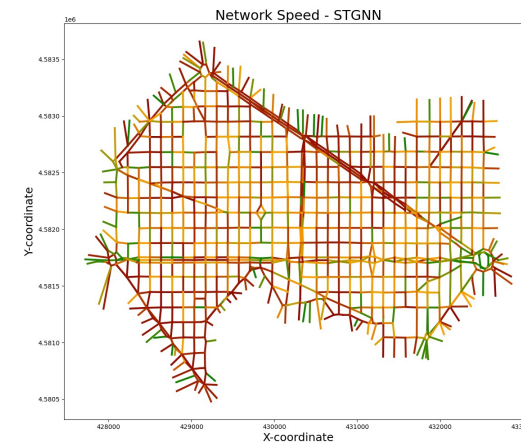
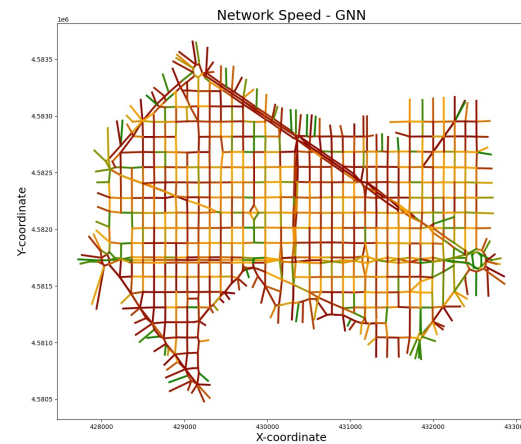
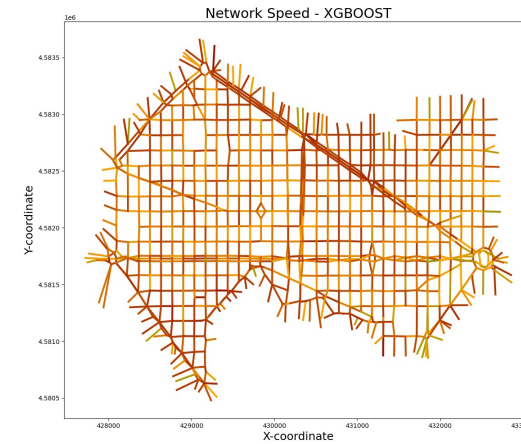
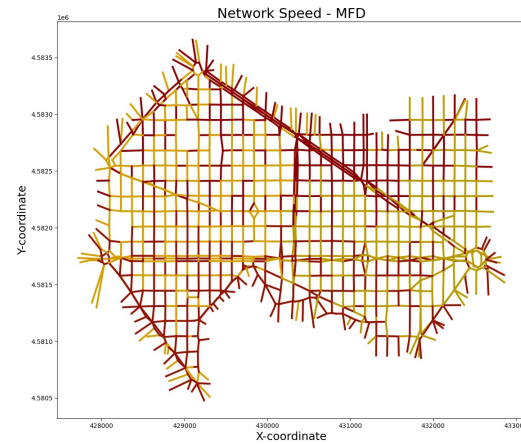
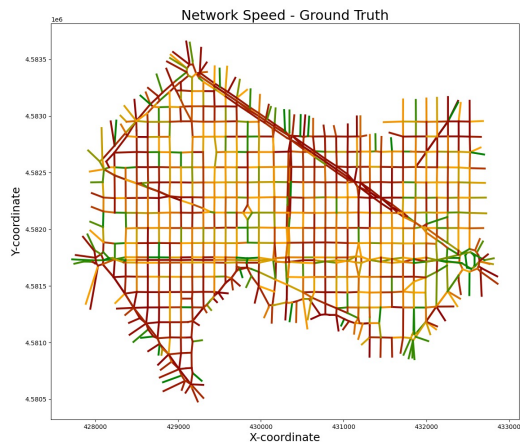

Conclusion

Summary & Future study

- Propose a deep learning method to estimate link speed based on spatial characteristics of the network and Macroscopic Fundamental Diagram (MFD)
 - **Local correction factor**
 - STGNN shows high performance among various baseline models
 - Apply network partitioning to improve model performance
 - Robust in various scenarios (demand + OD distribution + road configuration)
- Application in future study
 - Different city networks
 - Solve traffic optimization problems



103rd Annual Meeting of Transportation Research Board
ACP50 – Traffic Flow Theory and Characteristics Committee
3002 – Network Modeling and Control

Thank you for your attention

Zhixiong JIN^{1,2}, Dimitrio Tsitsokas², Nikolas Geroliminis² and Ludovic Leclercq¹

zhixiong.jin@univ-eiffel.fr

¹ Univ.Gustave Eiffel, ENTPE, LICIT-ECO7, Lyon, France

² École Polytechnique Fédérale de Lausanne (EPFL), Urban Transport Systems Laboratory, Switzerland



This project has received funding from the European Union's Horizon 2020 research and innovation program under Grant Agreement no. 953783 (DIT4TraM).



Graduate School of Civil, Environmental and Urban Engineering

Reference

1. Geroliminis, Nikolas, and Carlos F. Daganzo. "Existence of urban-scale macroscopic fundamental diagrams: Some experimental findings." *Transportation Research Part B: Methodological* 42.9 (2008): 759-770.
2. Daganzo, Carlos F., and Nikolas Geroliminis. "An analytical approximation for the macroscopic fundamental diagram of urban traffic." *Transportation Research Part B: Methodological* 42.9 (2008): 771-781.
3. Mariotte, Guilhem, et al. "Calibration and validation of multi-reservoir MFD models: A case study in Lyon." *Transportation Research Part B: Methodological* 136 (2020): 62-86.
4. Ingole, Deepak, Guilhem Mariotte, and Ludovic Leclercq. "Perimeter gating control and citywide dynamic user equilibrium: A macroscopic modeling framework." *Transportation research part C: emerging technologies* 111 (2020): 22-49
5. Jia, Yuhan, Jianping Wu, and Yiman Du. "Traffic speed prediction using deep learning method." *2016 IEEE 19th international conference on intelligent transportation systems (ITSC)*. IEEE, 2016.
6. Lu, Zhilong, et al. "LSTM variants meet graph neural networks for road speed prediction." *Neurocomputing* 400 (2020): 34-45.
7. Zhang, Chenhan, et al. "FASTGNN: A topological information protected federated learning approach for traffic speed forecasting." *IEEE Transactions on Industrial Informatics* 17.12 (2021): 8464-8474.
8. Xie, Zhipu, et al. "Sequential graph neural network for urban road traffic speed prediction." *IEEE Access* 8 (2019): 63349-63358.
9. Liu, Duanyang, Mengting Wang, and Guojiang Shen. "A new combinatorial characteristic parameter for clustering-based traffic network partitioning." *IEEE Access* 7 (2019): 40175-40182
10. Saeedmanesh, Mohammadreza, and Nikolas Geroliminis. "Dynamic clustering and propagation of congestion in heterogeneously congested urban traffic networks." *Transportation research procedia* 23 (2017): 962-979.
11. Tsitsokas, Dimitrios, Anastasios Kouvelas, and Nikolas Geroliminis. "Modeling and optimization of dedicated bus lanes space allocation in large networks with dynamic congestion." *Transportation Research Part C: Emerging Technologies* 127 (2021): 103082.

Performance Evaluation

Result (1) – Test in normal scenario (median demand loading)

- Deep learning-based model → high performance
 - STGNN: 1.3131 km/h error
- Different output → small performance differences
- Temporal information → improve performance
 - DNN vs STDNN, GNN vs STGNN

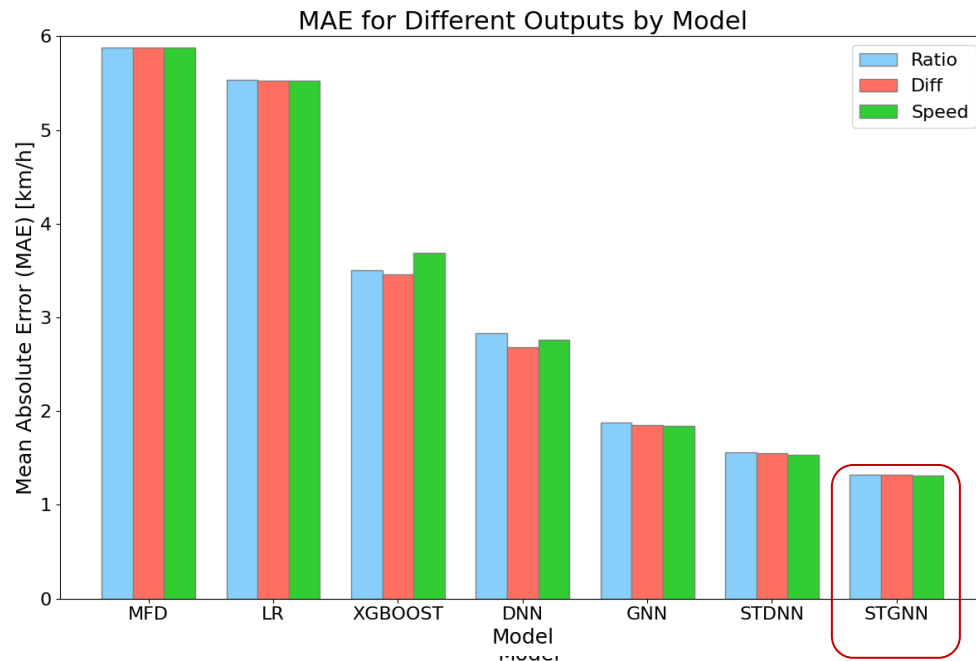

Tab 1: Performance evaluation with medium demand [km/h]

| Model | Output | MAE | MSE | Error Mean | Error STD |
|---------|--------|---------------|---------------|----------------|---------------|
| MFD | - | 5.8808 | 48.7415 | 0.0000 | 6.9815 |
| LR | Ratio | 5.5348 | 44.1518 | 0.0119 | 6.6447 |
| | Diff | 5.5225 | 43.8645 | 0.0058 | 6.6230 |
| | Speed | 5.5226 | 43.8645 | 0.0066 | 6.6230 |
| XGBOOST | Ratio | 3.5032 | 25.0235 | 0.0934 | 5.0015 |
| | Diff | 3.4632 | 24.7820 | 0.0661 | 4.9777 |
| | Speed | 3.6887 | 27.2620 | 0.1501 | 5.2191 |
| DNN | Ratio | 2.8330 | 20.7619 | 0.2742 | 4.5483 |
| | Diff | 2.6806 | 19.7136 | 0.1808 | 4.4363 |
| | Speed | 2.7575 | 20.5260 | 0.2339 | 4.5245 |
| GNN | Ratio | 1.8784 | 12.8576 | 0.0471 | 3.5854 |
| | Diff | 1.8540 | 12.6814 | 0.0673 | 3.5605 |
| | Speed | 1.8466 | 12.8286 | 0.0954 | 3.5804 |
| STDNN | Ratio | 1.5591 | 8.8222 | 0.0806 | 2.9691 |
| | Diff | 1.5492 | 8.8086 | 0.0628 | 2.9587 |
| | Speed | 1.5338 | 8.7474 | 0.0538 | 2.9571 |
| STGNN | Ratio | 1.3250 | 7.6582 | 0.0649 | 2.7683 |
| | Diff | 1.3251 | 7.3392 | 0.0649 | 2.7083 |
| | Speed | 1.3131 | 7.3091 | -0.0124 | 2.7073 |

Performance Evaluation

Result (2) – Test in normal scenario (median demand loading)

- Add network partitioned information → improve overall performances
 - STGNN: 1.0404 km/h error → 0.3km/h improvement
 - Efficient in model performance

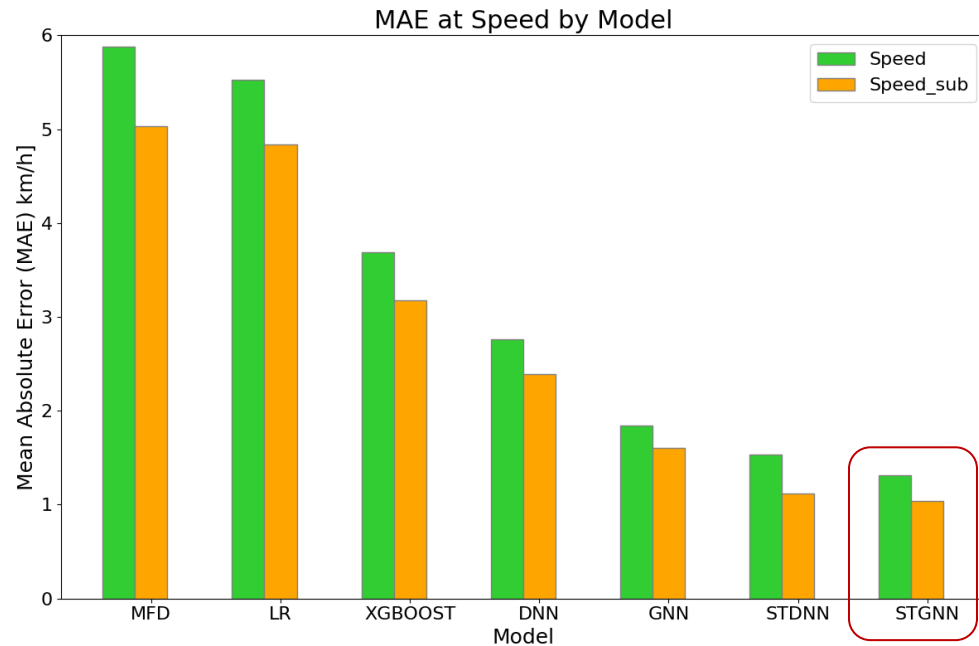

Tab 2: Performance evaluation with medium demand [km/h]

| Model | MAE | MSE | Error Mean | Error STD |
|------------------|---------------|---------------|----------------|---------------|
| MFD | 5.8808 | 48.7415 | 0.0000 | 6.9815 |
| MFD_sub | 5.0319 | 37.5756 | 0.0000 | 6.1299 |
| LR | 5.5226 | 43.8645 | 0.0066 | 6.6230 |
| LR_sub | 4.8373 | 35.1528 | 0.0048 | 5.9290 |
| XGBOOST | 3.6887 | 27.2620 | 0.1501 | 5.2191 |
| XGBOOST_sub | 3.1742 | 22.4228 | 0.1341 | 4.7334 |
| DNN | 2.7575 | 20.5260 | 0.2339 | 4.5245 |
| DNN_sub | 2.3885 | 17.0077 | 0.1513 | 4.1213 |
| GNN | 1.8466 | 12.8286 | 0.0954 | 3.5804 |
| GNN_sub | 1.6075 | 10.2265 | 0.0895 | 3.1966 |
| STDNN | 1.5338 | 8.7474 | 0.0538 | 2.9571 |
| STDNN_sub | 1.1184 | 5.6825 | 0.0321 | 2.3836 |
| STGNN | 1.3131 | 7.3392 | -0.0124 | 2.7073 |
| STGNN_sub | 1.0404 | 5.3646 | -0.0265 | 2.3160 |

Performance Evaluation

Result (3) – Test in extreme scenarios (low and high demand loading)

- Performance slightly decreases
 - STGNN - Low: 1.3206 km/h error, high: 1.4678 km/h error
 - Robustness of model in different scenarios (demand + OD + road configuration)

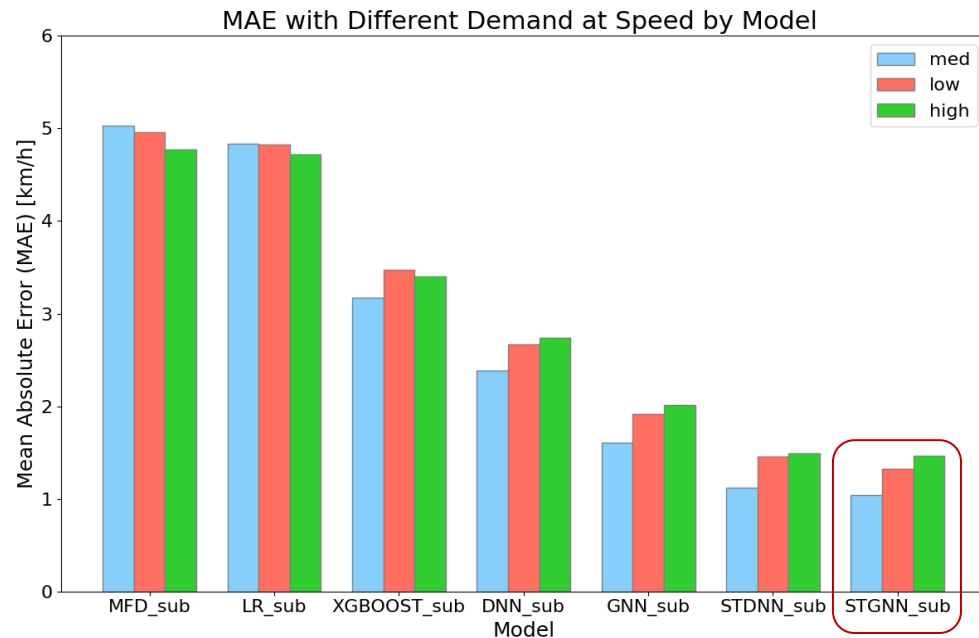

Tab 3: Performance evaluation with various demand [km/h]

| Model | Demand | MAE | MSE | RMSE | Error Mean | Error STD |
|-------------|--------|--------|---------|--------|------------|-----------|
| MFD_sub | med | 5.0319 | 37.5756 | 6.1299 | 0.0000 | 6.1299 |
| | low | 5.5052 | 44.9693 | 6.7059 | 0.0000 | 6.7059 |
| | high | 5.8304 | 48.8893 | 6.9921 | 0.0000 | 6.9921 |
| LR_sub | med | 4.8373 | 35.1528 | 5.9290 | 0.0048 | 5.9290 |
| | low | 4.8244 | 35.3243 | 5.9434 | 0.1385 | 5.9418 |
| | high | 4.7180 | 34.7639 | 5.8961 | -0.1045 | 5.8952 |
| XGBOOST_sub | med | 3.1742 | 22.4228 | 4.7353 | 0.1341 | 4.7334 |
| | low | 3.4769 | 26.7450 | 5.1716 | 0.0459 | 5.1713 |
| | high | 3.3997 | 25.4555 | 5.0453 | 0.0894 | 5.0446 |
| DNN_sub | med | 2.3885 | 17.0077 | 4.1240 | 0.1513 | 4.1213 |
| | low | 2.6696 | 21.7672 | 4.6655 | 0.1226 | 4.6639 |
| | high | 2.7350 | 21.1608 | 4.6001 | 0.0771 | 4.5994 |
| GNN_sub | med | 1.6075 | 10.2265 | 3.1979 | 0.0895 | 3.1966 |
| | low | 1.9137 | 14.5917 | 3.8199 | 0.0833 | 3.8190 |
| | high | 2.0134 | 14.7896 | 3.8457 | 0.1276 | 3.8436 |
| STDNN_sub | med | 1.1184 | 5.6825 | 2.3838 | 0.0321 | 2.3836 |
| | low | 1.4564 | 9.8931 | 3.1453 | 0.0625 | 3.1447 |
| | high | 1.4951 | 9.7429 | 3.1214 | -0.0689 | 3.1206 |
| STGNN_sub | med | 1.0404 | 5.3646 | 2.3162 | -0.0265 | 2.3160 |
| | low | 1.3206 | 6.9429 | 2.6349 | 0.1021 | 2.6330 |
| | high | 1.4678 | 8.9182 | 2.9863 | -0.0034 | 2.9863 |