



HAL
open science

Enantiopurity by directed evolution of crystallization behaviour and nonequilibrium conditions

Clément Pinètre, Sjoerd van Dongen, Clément Brandel, Anne-Sophie Léonard, Maxime Charpentier, Valerie Dupray, Kasper Oosterling, Bernard Kaptein, Michel Leeman, Richard Kellogg, et al.

► To cite this version:

Clément Pinètre, Sjoerd van Dongen, Clément Brandel, Anne-Sophie Léonard, Maxime Charpentier, et al.. Enantiopurity by directed evolution of crystallization behaviour and nonequilibrium conditions. The 29th BIWIC – International Workshop on Industrial Crystallization, 2024. hal-04698380

HAL Id: hal-04698380

<https://hal.science/hal-04698380v1>

Submitted on 16 Sep 2024

HAL is a multi-disciplinary open access archive for the deposit and dissemination of scientific research documents, whether they are published or not. The documents may come from teaching and research institutions in France or abroad, or from public or private research centers.

L'archive ouverte pluridisciplinaire **HAL**, est destinée au dépôt et à la diffusion de documents scientifiques de niveau recherche, publiés ou non, émanant des établissements d'enseignement et de recherche français ou étrangers, des laboratoires publics ou privés.

BIWIC 2024

Book of Abstracts & Posters



11th - 13th September 2024
Delft, The Netherlands





Hosted by



Delft University of Technology

Sponsors



Poster Awards



Football T-shirt





Committee

Scientific

- Gérard Coquerel | University of Rouen, France
- H. Burak Eral | Delft University of Technology, The Netherlands
- Sônia Denise Ferreira Rocha | Universidade Federal de Minas Gerais, Brazil
- Adrian Flood | Vidyasirimedhi Institute of Science and Technology, Thailand
- Kerstin Forsberg | Royal Institute of Technology, Sweden
- Hongxun Hao | Tianjin University, China
- Alison Lewis | University of Cape Town, South Africa
- Heike Lorenz | Max-Planck Inst., Magdeburg, Germany
- Marjatta Louhi-Kultanen | Aalto University, Finland
- Daniele Marchisio | Politecnico di Torino, Italy
- Hugo Meekes | Radboud University, The Netherlands
- Torsten Stelzer | University of Puerto Rico, USA
- Joachim Ulrich | Martin-Luther University, Germany
- Kerstin Wohlgemuth | TU Dortmund, Germany

Organizing

- H. Burak Eral | Delft University of Technology, The Netherlands
- Fred Marques Penha | KTH Royal Institute of Technology, Sweden
- Joop ter Horst | Tiofarma, The Netherlands
- Michael Svärd | KTH Royal Institute of Technology, Sweden
- Leslie van Leeuwen | Delft University of Technology, The Netherlands
- Leonie de Kluijs | Delft University of Technology, The Netherlands
- An Qi | Delft University of Technology, The Netherlands
- Wang Zhaopeng | Delft University of Technology, The Netherlands
- Julien Postma | Delft University of Technology, The Netherlands
- Chérise Tomsjansen | Delft University of Technology, The Netherlands
- Pepijn van Tooren | Delft University of Technology, The Netherlands



ABSTRACTS



Content of Abstract for Oral Presentations

A new take on caking and anticaking agents for NaCl.....	1
A novel pilot-scale crystallizer for the production of Mg(OH) ₂ compound from salt solutions.....	2
Agglomerated Crystallization of Medium-Chain Organic Acids Salts.....	4
Continuous production of single enantiomers by coupling enantioselective fluidized bed crystallization with enzymatic racemization.....	5
Control over sodium sulfate hydrates formation upon temperature cycling for sustainable thermal energy storage.....	6
Crystal Growth and Dissolution Behavior Throughout Temperature Cycle Induced Deracemization	8
Crystallization kinetics of full-length monoclonal antibodies across varying scales.....	9
Crystallization Process with Solid Form Control for Integrated Continuous Drug Substance Manufacturing.....	10
Enantiopurity by directed evolution of crystallization behaviour and non-equilibrium conditions	11
Feasibility of Data-Driven Model to Predict Crystallisation Induction Time.....	12
Impact of Foreign Species on Crystallization: Process Design and Monitoring.....	13
Importance of Seed Design to Crystallization-Induced Deracemizations	14
In-Situ studies of Crystallization and Filtration processes using Time-Resolved synchrotron based X-Ray Phase Contrast Imaging (XPCI)	15
Integration of Deep Learning and 3D CFD-PBM Model for Characterizing Mg(OH) ₂ Precipitation.....	16
New insights into the solubilization of multicomponent crystals: a case study of pipemidic acid	18
Potential of Eutectic Freeze Crystallization for Lithium-Containing Boron Extraction Waste Stream	20
Probing the nature of the crystal-solution boundary layer: an experimental campaign studying secondary nucleation from nuclei breeding.....	21
Process Development for Recovery of Lithium Carbonate from a Battery Recycling Process	22
Simultaneous and Sequential Precipitation from Lithium-Ion Batteries (LIBs) Recycling Process	23
The deployment of 2D population balance modelling to optimise particle processability in pharmaceutical crystallisation processes.....	24
Towards sustainability in industry: PET recycling approaches on an industrial scale.....	25
Understanding the Effect of Screw Design on Continuous Particle Isolation Performance within the Continuous Vacuum Screw Filter.....	26
Using CO ₂ to precipitate MnCO ₃ for a lithium-ion battery precursor	28



A new take on caking and anticaking agents for NaCl

Dan G. Dumitrescu,* Eric Berghuis, Aalbert Zwijnenburg

¹Nobian, RD&I Salt, Deventer, The Netherlands;

* dan.dumitrescu@nobian.com

Keywords: anticaking agent, sodium chloride, ferrocyanide

Salt (NaCl) has always been a staple of human activity, both as a food additive and, in the present day, as a feedstock for the chemical industry. Salt however has the tendency to cake, which can greatly complicate its transportation, unloading/loading and storage. Fundamentally, caking of salt is perceived as a drying process, driven mostly by the fluctuations in temperature and humidity of the environment. These fluctuations result in successive dissolution and recrystallization cycles which in turn lead to salt bridges formed between the particles. Several strategies can be adopted to mitigate salt caking, either a thorough control of the moisture levels and storage conditions or via the addition of anticaking agents. Significant research into the latter has been ongoing since the early 1960s. One of the first identified anticaking agents, and probably the most widely used today, is the complex ion ferrocyanide, $[\text{Fe}(\text{CN})_6]^{4-}$. [1] This octahedral ion replaces can replace $[\text{NaCl}_6]^{5-}$ on the sodium chloride lattice surface due to their near perfect geometric match and charge similarity. However, the charge mismatch between the two results in an energetically unfavorable de-adsorption from the lattice, and therefore inhibiting the formation of crystal bridges. [2] Previous literature states that, while other octahedral hexacyanide complexes exist, they are worse anticaking agents than ferrocyanide due to larger geometric and/or charge mismatches. [1] This anticaking mechanism was checked experimentally using both AFM and surface diffraction experiments. [3] Furthermore, $[\text{Fe}(\text{CN})_6]^{4-}$ was recently investigated as a potential anticaking agent for other cubic salts. [4]

Herein we present a new interpretation of caking as a dynamic phenomenon, under constant moisture conditions, and present a new testing method. The role of time, pressure and temperature on the caking of salt are also explored. In this new interpretation, salt caking is not a drying process, but rather a surface minimization phenomenon. Furthermore, we re-investigate other cyanide complexes and compare their effect to $[\text{Fe}(\text{CN})_6]^{4-}$, namely $[\text{Ru}(\text{CN})_6]^{4-}$, $[\text{Fe}(\text{CN})_6]^{3-}$ and $[\text{Co}(\text{CN})_6]^{3-}$, as well as the square planar $[\text{Ni}(\text{CN})_4]^{2-}$. In this way, we show that the geometric compatibility between the NaCl lattice and the cyanide complex has less influence than previously thought. Furthermore, we show a marked difference between the results ‘dry’ and ‘wet’ caking test methods on these compounds.

- [1] M.A. van Damme-van Weele, (1965) **Influence of Additives on the Growth and Dissolution of NaCl Crystals**, TU Twente d. Ph.D. thesis.
- [2] M. Mauriaucourt, S. Jiang, A. Soare, A. Zwijnenburg, N. Shahidzadeh, (2020) **Multiscale Study on the Mechanism of a Bio-Based Anticaking Agent for NaCl Crystals**, *ACS Omega*, 5(49) , 31575.
- [3] A. A. C. Bode, V. Vonk, F.J. vanden Bruele, D.J. Kok, A.M. Kerkenaar, M.F. Mantilla, S. Jiang, J.A.M. Meijer, W.J.P. van Enkevort, E. Vlieg, E. (2012) **Anticaking Activity of Ferrocyanide on Sodium Chloride Explained by Charge Mismatch** *Cryst. Growth. Des.*, 12, 1919.
- [4] M.A.R. Blijlevens, E.R. Townsend, P. Tinnemans, W.J.P. van Enkevort, E. Vlieg, (2022) **Effect of the Anticaking Agent FeCN on the Creeping Properties of Alkali Halide Crystals** *Cryst. Growth. Des.*, 22, 6575.

A novel pilot-scale crystallizer for the production of $Mg(OH)_2$ compound from salt solutions

G. Battaglia^{1,*}, F. Miciletta¹, G. Scelfo^{1,2}, F. Vassallo¹, F. Vicari², A. Tamburini¹, A. Cipollina¹, G. Micale¹

¹ Dipartimento di Ingegneria, Università degli Studi di Palermo, Palermo, Viale delle Scienze, 90128, Italy;

² ResourSEAs SrL, Via Notarbartolon. 38, 90141 Palermo, Italy

*giuseppe.battaglia03@unipa.it

Keywords: reactive crystallization, particle growth, mineral recovery

Magnesium hydroxide, $Mg(OH)_2$, is an inorganic compound adopted in numerous industrial applications. It is mainly synthesized from magnesium-rich minerals. Nevertheless, $Mg(OH)_2$ can be produced from magnesium-rich solutions by reactive crystallization [1]. The production of $Mg(OH)_2$ powders by reactive crystallization, however, is hindered by the low thickening and filterability characteristics of the synthesized slurries. This issue is even more critical when sodium hydroxide, NaOH, solutions are adopted as alkaline reagents [2].

In this work, a novel pilot-scale crystallizer is presented for the recovery of Mg^{2+} , in the form of magnesium hydroxide, from saltworks bitterns. Bitterns are the by-product stream of the sea salt production from seawater. Mg^{2+} concentration in bitterns can reach values up to 60 g/L, being more than 30 times that in seawater. The design of the crystallizer aimed at minimizing the local supersaturation level all over the reactor volume. This was achieved by adopting a double-product recirculation strategy to (i) dilute reagents before entering the reactor and (ii) dilute the reaction environment. Different inlet reagent configurations were investigated leading to the production of either globular-shaped $Mg(OH)_2$ nanoparticles or sand rose-like nano-platelets, as shown in Figure 1.

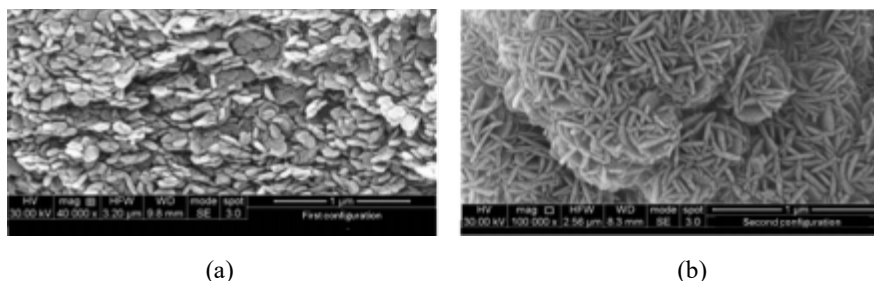

Figure 1 (a) Nano-globular $Mg(OH)_2$ particles; (b) sand-rose like $Mg(OH)_2$ nano-platelet produced by adopting the novel crystallizer under different inlet reagent configurations.



In the case of sand-rose nano-platelets, a ~ 12 g/L $\text{Mg}(\text{OH})_2$ suspension was produced by adopting a 0.5 M synthetic NaOH solution and a ~ 48 g/L Mg^{2+} -containing bittern, collected from Margi saltworks (Trapani, Italy). A thickening rate of ~ 500 mm/h and a filtration rate of ~ 85 kg/(m² h) were measured, being more than three times faster than data reported in the literature [2]. The novel pilot scale crystallizer represents a reliable technology for the production of $\text{Mg}(\text{OH})_2$ suspensions with excellent filtration and thickening performances from salt solutions for $\text{Mg}(\text{OH})_2$ supply in the European Union.

Acknowledgments

This project has received funding from the European Union's Horizon 2020 research and innovation programme under Grant Agreement No. 869467 (SEArcularMINE). This output reflects only the author's view. The European Health and Digital Executive Agency (HaDEA) and the European Commission cannot be held responsible for any use that maybe made of the information contained therein.

References

- [1] G. Battaglia, M.A. Domina, R. Lo Brutto, J. Lopez Rodriguez, M. Fernandez de Labastida, J.L. Cortina, A. Pettignano, A. Cipollina, A. Tamburini, and G. Micale (2023): **Evaluation of the Purity of Magnesium Hydroxide Recovered from Saltwork Bitterns**, *Water*, 15.
- [2] M. Turek and W. Gnot (1995): **Precipitation of Magnesium Hydroxide from Brine**, *Ind. Eng. Chem. Res.*, vol. 34, no. 1, pp. 244–250.



Agglomerated Crystallization of Medium-Chain Organic Acids Salts

L. Codan^{1*}, C. Pons Siepermann², and E. Sirota²

¹PR&D, MSD Werthenstein BioPharma, Schachen LU, Switzerland;

²PR&D, Merck & Co., Inc., Rahway, NJ, USA;

*lorenzo.codan@msd.com

Keywords: agglomeration, liquid-liquid phase separation, suppressing gel formation

Sodium salts of medium chain saturated organic acids are surprisingly difficult to crystallize. These molecules have a strong propensity towards gelling and making unstirrable slurries in most solvent systems. The natural crystalline morphology for these compounds is long fibers/needles that are difficult to isolate in standard equipment trains, have undesirable powder properties for formulation applications, and tend to entrain solvent. Commercially available material of this kind is typically isolated through spray-drying (limited morphology control), or retains the suboptimal fiber-like morphology. We have developed a novel approach for the crystallization of this kind of compounds, leveraging particle agglomeration induced by liquid- liquid phase separation. By identifying a highly specific solvent composition that suppresses gel formation and entraps the solids within the dispersed droplets of the second phase, we designed a single-pot, low-energy crystallization process using cheap, commercially accessible starting materials. The resulting solids are agglomerates of tunable particle size with powder properties superior to those of commercially available alternatives. In this contribution, the history that led to this discovery, the process handles that can be used to control the product particle size, our understanding of the mechanisms that govern the agglomeration, and the design optimizations that were used to reach a scalable and transferrable process sequence will be presented.



Continuous production of single enantiomers by coupling enantioselective fluidized bed crystallization with enzymatic racemization

K. Oliynyk*, J. Gänsch, A. Seidel-Morgenstern, H. Lorenz

Max Planck Institute for Dynamics of Complex Technical Systems, Magdeburg, Germany

* oliynyk@mpi-magdeburg.mpg.de

Keywords: enantiomers, fluidized bed crystallization, enzymatic racemization, chiral resolution, chiral inversion

The manufacturing of enantiopure substances is increasingly on demand for the pharmaceutical, fine chemical and other life science industries. Due to a high similarity of the enantiomers of a chiral substance in chemical and physical properties, the production of single enantiomers is challenging and cost-intensive. One of the common approaches is the production of the racemic (50:50) mixture followed by a resolution process. This can be achieved using Preferential Crystallization which allows the direct crystallization of a pure target-enantiomer from a racemic solution. Since in many cases only one of the enantiomers is needed, the yield of this process is limited to 50%. As proposed in former work [1], this yield limitation can be avoided by coupling the Preferential Crystallization with an enzymatic racemization.

In this work, a novel process configuration for the efficient coupling of an enzymatic racemization with enantioselective fluidized bed crystallization is developed facilitating the continuous production of single enantiomers. The proposed process uses a fixed bed reactor, packed with immobilized racemase [1] for enzymatic racemization and two-stage fluidized bed crystallization setup [2]. The mother liquor is continuously recycled without solvent removal. This approach promises an efficient utilization of the enzyme as well as the continuous production of the target enantiomer at 100% theoretical yield. Furthermore, the proposed process is suitable for continuous chiral inversion, utilizing an undesired enantiomer as feed and continuously converting it to a desired target enantiomer [3]. In this contribution, the proposed process configuration will be introduced and its performance investigated via process modeling and pilot plant experiments described in detail. Two different applications are studied: First, the continuous production of one desired enantiomer from a racemic feedstock, and second, the continuous chiral inversion of an undesired enantiomer to its desired form. The simulation results will be evaluated and discussed with respect to productivity, process robustness and limitations of the operation window. Finally, experimental results will be for the substance system D/L-asparagine monohydrate/water.

- [1] T. Carneiro, K. Wrzosek, K. Bettenbrock, H. Lorenz, and A. Seidel-Morgenstern (2020): **Immobilization of an amino acid racemase for application in crystallization-based chiral resolutions of asparagine monohydrate** *Eng Life Sci.*, 20, 550-561.
- [2] J. Gänsch, N. Huskova, K. Kerst, E. Temmel, H. Lorenz, M. Mangold, G. Janiga, and A. Seidel-Morgenstern (2021): **Continuous enantioselective crystallization of chiral compounds in coupled fluidized beds**, *Chemical Engineering Journal*, 422, 129627.
- [3] J. Gänsch, K. Oliynyk, H. Lorenz, A. Seidel-Morgenstern (2024): **Continuous chiral inversion by coupling enantioselective fluidized bed crystallization with enzymatic racemization**, Manuscript in preparation.



Control over sodium sulfate hydrates formation upon temperature cycling for sustainable thermal energy storage

A. Claude^{1*}, J. vande Groep¹ and N. Shahidzadeh¹

Institute of Physics, Van der Waals-Zeeman Institute, University of Amsterdam,
Science Park 904, 1098 XH Amsterdam, The Netherlands;

*a.claude@uva.nl

Keywords: salt hydrate, sodium sulfate, thermal energy storage, hydration, supercooling

Salt hydrates are inorganic salts ($X \cdot nH_2O$) containing a fixed number of water molecules in the crystalline lattice. They form an important class of materials both as thermochemical and Phase Change Materials [1-2] in terms of theoretical storage capacity ($\sim 1-3 \text{ GJ/m}^3$) by producing heat during the hydration and storing heat during dehydration [3-5]. In built environment, based on the reversible dehydration / hydration reaction temperatures, these hydrated salts can provide cooling or heating by taking up heat during the day at their phase change temperature until all the material is converted from solid to liquid. Subsequently, at night when the temperature drops, they can convert to their solid state and release the latent heat that was stored. One potential concrete application of these salts could be for domestic usage like boiling water.

However, the deployment of these crystalline materials in a sustainable way is still limited because of a number of technical challenges such as a broad transition temperature range, supercooling hysteresis and degradation with cycling (i.e. irreversible phase transformation) [6]. Here, we perform a systematic study on sodium sulfate hydrates precipitation and dissolution by temperature cycling in the range of -20 to 50°C for a range of concentrations based on the equilibrium phase diagram of sodium sulfate in water [7] and map the crystallization of the heptahydrate and decahydrate (mirabilite) forms using laser- transmittance experiments and confocal Raman microspectroscopy. Our results show that upon cooling/heating cycles at a given concentration, the system doesn't follow the predicted phase transition with the precipitation of the decahydrate form. The metastable heptahydrate form precipitates spontaneously independent of the concentration of the solutes in the solution. The metastability limit for the precipitation of the heptahydrate crystals have been therefore identified. Our findings highlight that experimentally the phase diagram is more complex than what is established in literature, and there is a distinct nucleation barrier for mirabilite that needs to be mitigated to benefit from the large latent heat associated with the phase transition.



Consequently, to overcome this nucleation barrier, different types of impurity have been added to the sodium sulfate solution (2.8 molal) prior to cycling to promote the nucleation of the decahydrate form. Our results show that the impurities have no significant impact on the reduction of the activation energy barrier and that the precipitation of the decahydrate form cannot occur from undersaturated salt solutions with and without particles upon cooling down to 0°C.

- [1] M.M. Farid, A. M. Khudhair, S. A. K. Razack, S. Al-Hallaj (2004): **A review on phase change energy storage: materials and applications**, *Energy Conversion and Management*, 45, 1597-1615.
- [2] G. A. Lane (1992): **Prevention of supercooling and stabilization of inorganic salt hydrates as latent heat storage materials**, *Solar Energy Materials and Solar Cells*, 27, 135-160.
- [3] P.A.J. Donkers, L.C. Sögütöglu, H.P. Huinink, H.R. Fisher, O.C.G. Adan (2017), **A review of salt hydrates for seasonal heat storage in domestic application**, *Applied Energy*, 199, 45-68.
- [4] A. Sharma, V.V. Tyagi, C.R. Chen, D. Buddhi (2009): **Review on thermal energy storage with phase change materials and applications**, *Renewable and Sustainable Energy Reviews*, 13, 318-345.
- [5] A. Safari, R. Saidur, F.A. Sulaiman, Y. Xu, J. Dong (2017): **A review on supercooling of Phase Change Materials in thermal energy storage systems**, *Renewable and Sustainable Energy Reviews*, 70, 905-919.
- [6] P. Marliacy, R. Solimando, M. Bouroukba, L. Schuffenecker (2000): **Thermodynamics of crystallization of sodium sulfate decahydrate in H₂O-NaCl-Na₂SO₄: application to Na₂SO₄ · 10H₂O-based latent heat storage materials**, *Thermochimica Acta*, 344, 85-94
- [7] M. Steiger, S. Amussen (2008): **Crystallization of sodium sulfate phases in porous materials: The phase diagram Na₂SO₄-H₂O and the generation of stress**, *Geochimica et Cosmochimica Acta*, 72, 4291-4306.



Crystal Growth and Dissolution Behavior Throughout Temperature Cycle Induced Deracemization

J. Maeda^{1,2}, P. Cardinael², A. Flood¹, and G. Coquerel^{2*}

¹Faculty of Energy Science and Engineering, Vidyasirimedhi Institute of Science and Engineering (VISTEC), Rayong, Thailand

²Univ Rouen Normandie, Normandie Univ, SMS UR 3233, F-76000 Rouen, France

[*gerard.coquerel@univ-rouen.fr](mailto:gerard.coquerel@univ-rouen.fr)

Keywords: Deracemization, temperature cycling, mechanism.

Temperature cycle-induced deracemization (TCID) has been shown to be a promising method to obtain enantiomerically pure compounds. By introducing temperature swings in place of grinding (for Viedma ripening), significant changes in dissolution and crystal growth are achieved, which accelerate the overall process time from a few weeks to a few hours. Due to the similarity in these processes, the behavior of crystal growth and dissolution, and the driving force of deracemization, has been assumed to be identical; that solubility depends solely on crystal size, with the minor enantiomer being smaller on average. In Viedma ripening, attrition alters the crystal size distribution, while in TCID, minor enantiomers dissolve more readily during heating, increasing the crystal enantiomeric excess (c.e.e.) and cooling allows both enantiomers to crystallize, decreasing the c.e.e. The difference in amplitude of these steps enable the system to reach enantiopurity [1].

Herein, experimental data of TCID on Cl-TAK (1-(4-chlorophenyl)-4,4-dimethyl-2-(1H-1,2,4-triazol-1-yl) pentan-3-one), which has been shown to successfully undergo deracemization by TCID [2] suggest that the heating and cooling have different effects on the evolution of c.e.e. throughout the course of the process. During the initial stages (low c.e.e.), heating increases the c.e.e., while cooling slightly decreases it, whereas near the end (high c.e.e.), heating decreases the c.e.e. and cooling increases it. The first half of TCID seems to align with previous computational works, but the latter half of the results suggest the opposite trend. As the process progresses, the population of the dominant enantiomer increases while the minor enantiomer decreases. This widening gap in population enhances the likelihood of the dominant enantiomer's dissolution due to its greater presence. In addition to the size-dependent solubility, this likely explains this phenomenon both statistically and kinetically.

This behavior of Cl-TAK during the course of heating and cooling steps throughout TCID challenges the current understanding on how these systems evolve, and consequently how calculations are made to model such systems.

[1] L.-T. Deck, M. S. Hosseinalipour, M. Mazzotti (2024): **Exact and Ubiquitous Condition for Solid-State Deracemization in Vitro and in Nature**, *J. Am. Chem. Soc.* 146, 3872-3882.



Crystallization kinetics of full-length monoclonal antibodies across varying scales

J. Ferreira^{1*}, D. Ranansinghe¹, J. Yadav¹, K. Chattaraj¹, K. Ganko¹, T. Stelzer^{1,2,3}, R. Braatz¹, B. Trout¹, and Allan Myerson¹

¹Department of Chemical Engineering, Massachusetts Institute of Technology,
400 Main Street, Cambridge MA 02142, USA;

²Department of Pharmaceutical Sciences, University of Puerto Rico – Medical
Sciences Campus, San Juan, Puerto Rico 00936, USA

³Crystallization Design Institute, Molecular Sciences Research Center, University of
Puerto Rico, San Juan, Puerto Rico 00926, USA

*joanaf@mit.edu

Keywords: Full-length mAb, crystallization, kinetics, thermodynamics

The growing demand for monoclonal antibodies (mAbs) production coupled with the high-cost of traditional chromatography columns requires the exploration of more cost-effective and sustainable alternatives [1]. Therefore, crystallization emerges as a cost-efficient purification strategy by reducing operational costs and facility size. Nevertheless, establishing the crystallization conditions of a full-length mAb remains a challenging task due to its size, complexity, and dynamic behavior, as well as the intricacy of all the occurring interactions (*e.g.* protein-protein interactions, protein-solvent interactions, etc.) [2]. Firstly, crystallization and/or precipitation states at a broad range of precipitant solutions (*e.g.* salts, co-solvents, additives) were investigated across varying scales from nanoliters to milliliters by ensuring optimal yields and purity levels of the target mAbs. Analytical techniques such as HPLC, protein A, SDS-PAGE, etc. were used to assess the quality and efficacy of the purified mAbs. In parallel, the underlying mechanism of crystallization propensity was investigated by molecular modeling and machine learning algorithms. Ultimately, needle-shaped crystals were obtained and characterized (*e.g.* XRD, Cryo-EM), and crystallization thermodynamics and kinetics parameters were quantified by combining automated optical microscopy capturing and image analysis techniques. In summary, establishing the crystallization conditions of a mAb remains a challenging task due to stochastic behavior of nucleation and the intricacy of all the occurring interactions. Moreover, the inherent flexibility of full-length mAbs leads to diverse conformational forms, which makes full-length antibody crystallization nearly impossible. However, the employed methodologies showed promising results to fully quantify crystallization kinetics of mAbs across a broad scale range.

- [1] A. Shukla *et al.* (2007): **Downstream processing of monoclonal antibodies - application of platform approaches**, *J Chromatogr B* 848, 28–39.
- [2] J. Ferreira and F. Castro (2023): **Advances in protein solubility and thermodynamics: quantification, instrumentation, and perspectives**, *CrystEngComm* 25, 6388–6404.



Crystallization Process with Solid Form Control for Integrated Continuous Drug Substance Manufacturing

Cornelis Vlaar,¹ Jean-Christophe Monbaliu,² Allan Myerson,³ Torsten Stelzer^{1,3,4*}

¹Department of Pharmaceutical Sciences, University of Puerto Rico, San Juan, Puerto Rico 00936, USA

²Center for Integrated Technology and Organic Synthesis, MolSys Research Unit, University of Liège, B-4000 Liège (Sart Tilman), Belgium

³Department of Chemical Engineering, Massachusetts Institute of Technology, Cambridge, MA 02139, USA

⁴Crystallization Design Institute, Molecular Sciences Research Center, University of Puerto Rico, San Juan, Puerto Rico 00926, United States

[*torsten.stelzer@upr.edu](mailto:torsten.stelzer@upr.edu)

Keywords: integrated manufacturing, solid form control, continuous

Though a vast number of publications report novel continuous synthesis (flow synthesis) processes for drug substances (a.k.a. APIs, e.g., [1,2]), till today their integration with vital continuous crystallization to produce crystalline APIs has not been realized to the same extent.[3] In this study, we will report the purification for an API obtained by flow synthesis via continuous crystallization to deliver it as crystalline material ready for formulation in the desired solid form (e.g., polymorph, solvate). Ultimately, this study represents a vital step that contributes to the overarching goal of integrating crystallization with flow synthesis to reap the benefits of continuous manufacturing of pharmaceuticals.

- [1] Silva-Brenes, D. V; Emmanuel, N.; Lopez-Mejias, V.; Duconge Soler, J.; Vlaar, C.; Stelzer, T.; Monbaliu, J.-C. M. Out-Smarting Smart Drug Modafinil through Flow Chemistry. *Green Chem.* **2022**, *24*, 2094– 2103. <https://doi.org/10.1039/D1GC04666G>
- [2] Silva-Brenes, D. V; Reyes-Vargas, S. K.; Duconge, J.; Vlaar, C.; Stelzer, T.; Monbaliu, J.-C. M. Continuous Flow Intensification for the Synthesis of High-Purity Warfarin. *Org. Process Res. Dev.* **2023**. <https://doi.org/10.1021/acs.oprd.3c00338>
- [3] Stelzer, T.; Lakerveld, R.; Myerson, A. S. Process Intensification in Continuous Crystallization. In *The Handbook of Continuous Crystallization*; Yazdanpanah, N., Nagy, Z. K., Eds.; The Royal Society of Chemistry, 2020; pp 266–320. <http://dx.doi.org/10.1039/9781788013581-00266>



Enantiopurity by directed evolution of crystallization behaviour and non-equilibrium conditions

C. Pinetre^{1*}, S. W. vanDongen², C. Brandel¹, A-S. Leonard², G. Valenti³, M. Charpentier⁴, K. Oosterling³, B. Kaptein⁵, M. Leeman³, R. M. Kellogg³, J. H. ter Horst⁷, V. Dupray¹ and W. L. Noorduin²

¹ Univ Rouen Normandie, Normandie Univ, SMS, UR 3233, F-76000 Rouen, France

² AMOLF, Science Park 104, Amsterdam 1098 XG, The Netherlands. ³ Symeres, Kadijk 3, Groningen 9747 AT, The Netherlands

⁴ EPSRC, CMAC, University of Strathclyde, TIC, Glasgow, G11RD, U.K.

⁵ InnoSyn BV, Urmonderbaan 22, Geleen 6167 RD, The Netherlands

*clement.pinetre1@univ-rouen.fr

Keywords: Chirality, Chiral purification, Non-equilibrium conditions, Evolutionary design

Ever since the first sorting of enantiomers by Louis Pasteur, crystallization has become a powerful method for isolating molecules of a desired handedness. Although in the past century many variations of this method have been developed, widespread use of chiral purification by crystallization is still hindered by one imperative: enantiomers need to sort themselves in separate enantiopure crystals (*i.e.* racemic conglomerates). Unfortunately, the overwhelming majority of enantiomeric mixtures crystallizes into thermodynamically favored racemic compounds (90-95%), which hinders such separation techniques.[1] We suggest that this thermodynamic limitation may be overcome by exploiting non-equilibrium conditions, in which crystallization rates - instead of thermodynamic stabilities alone - may determine which crystalline phase dominates. This opens the potential to exploit non-equilibrium conditions for favoring enantiopure crystals at the expense of stable racemic compounds.[2]

Motivated by these insights, we analyzed energy differences between racemates and their enantiopure counterparts (ΔG^ϕ) for two libraries of biorelevant target molecules with different chemical modifications. We found, surprisingly, a large and continuous distribution of ΔG^ϕ , in which similar chemical modifications are clustering. This enabled a directed evolutionary design strategy (*i.e.* iterative methodological library design) to discover systems with low ΔG^ϕ ($< 0.5 \text{ kcal.mol}^{-1}$), for which we demonstrate that the desired enantiomer can be isolated by preferential crystallization or deracemization under non-equilibrium conditions.

Comparison with over a hundred previously reported racemic compounds suggests that the continuum of ΔG^ϕ of structurally related compounds offers much better odds for discovering kinetically stabilizable conglomerates (50-60%). Hence, both the evolutionary library design and exploitation of non-equilibrium open up many new opportunities for crystallization-based routes towards enantiopure molecules that are essential in our daily lives.

[1] J. Jacques, A. Collet, S. H. Wilen (1994): *Enantiomers, Racemates, and Resolutions*, Krieger Publishing Company: Malabar.

[2] C. Brandel, Y. Amharar, J. M. Rollinger, U. J. Griesser, Y. Cartigny, S. Petit, G. Coquerel (2013): **Impact of Molecular Flexibility on Double Polymorphism, Solid Solutions and Chiral Discrimination during Crystallization of Diprophylline Enantiomers**, Mol. Pharmaceutics, 10 (10), 3850-3861.



Feasibility of Data-Driven Model to Predict Crystallisation Induction Time

M.K. Mandaza^{1,2*}, C. Brown^{1,2}, and J. Sefcik^{1,3}

¹Strathclyde Institute of Pharmacy & Biomedical Sciences, University of Strathclyde,
Glasgow, UK

²EPSRC Future Manufacturing Hub for Continuous Manufacturing and Advanced
Crystallisation, Technology and Innovation Centre, University of Strathclyde, UK

³Department of Chemical and Process Engineering, University of Strathclyde,
Glasgow, UK

* mitchelle.mnemo@strath.ac.uk

Keywords: Active pharmaceutical ingredient (API), nucleation kinetics, scale-up, machine learning.

Active pharmaceutical ingredient (API) crystallisation is integral in the drug manufacturing process¹, influencing product quality, yield, and production efficiency. The more complex drug structures and advanced formulations become, the more challenging they are to crystallise². It is critical to understand the chemical and mechanical properties of solutes and solvents and their influence on induction time, a vital parameter of crystallisation kinetics. During the transition from laboratory-scale production to manufacturing, various technology transfer stages are necessary. It's crucial to recognise that different crystallisation systems may not respond uniformly to scale-up, and the effects on each active pharmaceutical ingredient (API) being developed can vary³.

Induction time is a key kinetic characteristic of crystallisation reactions⁴. A lack of understanding of how process parameters such as cooling rate and agitation influence crystallisation, makes controlling these processes more challenging and consequently affects the final drug product quality. The ability to accurately predict the induction time of a solute/solvent system will provide an initial step to the design and optimisation of crystallisers.

Machine learning methods have been used widely for the prediction of physicochemical properties and the prediction of suitable solvents for crystallisation^{5,6}. By implementing machine learning tools, this study explores the relationship between solute-solvent properties and induction times for APIs. A predictive model is developed utilising molecular features to forecast induction times for unknown solute-solvent combinations. These methods enable the understanding of the complex processes involved. As well as reducing resource waste and loss, they save experimental time. Comprehensive data analysis will reveal insights into the relationships between induction time and various variables, enabling appropriate predictions and informed decisions related to industrial crystallisation development.

- [1] Chanda A, Daly AM, Foley DA, Lapack MA, Mukherjee S, Orr JD, et al. Industry perspectives on process analytical technology: Tools and applications in API development. *Org Process Res Dev.* 2015;19(1):63-83.
- [2] Chen J, Sarma B, Evans JMB, Myerson AS. Pharmaceutical Crystallization Published as part of the Crystal Growth & Design 10th Anniversary Perspective. 2011;887-95.
- [3] Nere NK, Diwan M, Czyzewski AM, Marek JC, Sinha K, Li H. Case Studies on Crystallization Scale-Up. *Chem Eng Pharm Ind.* 2019;617-33.
- [4] Maosoongnern S, Flood AE. Validation of Models Predicting Nucleation Rates from Induction Times and Metastable Zone Widths. *Chem Eng Technol.* 2018;41(10):2066-76.
- [5] Boobier S, Hose DRJ. Machine learning with physicochemical relationships: solubility prediction in organic solvents and water. *Nat Commun* [Internet]. (2020):1-10. Available from: <http://dx.doi.org/10.1038/s41467-020-19594-z>
- [6] Diaz LP, Brown J, Ojo E. Machine Learning Approaches to the Prediction of Powder Flow Behaviour of Pharmaceutical Materials from Physical Properties. :1-11.



Impact of Foreign Species on Crystallization: Process Design and Monitoring

Silvio Trespi¹*, Tommaso Guida¹, Marco Mazzotti¹

¹ETH Zurich, Institute of Energy and Process Engineering, 8092 Zurich, Switzerland

*strespi@ipe.mavt.ethz.ch

Keywords: Chromatography, Crystallization, Impurity Rejection, Population Balance Model

Crystallization process development focuses on finding the operating conditions that guarantee a high productivity, economically viable process while finding a compromise with product attributes like particle size and shape distribution, solid form and processability. However, satisfying the purity requirements in process development is a goal that does not accept a compromise. Crystallization is a separation technique that is known to achieve a high-purity product from a relative impure mother liquor. However, impurities are known to affect even in low quantities the outcome of the process and, therefore, it is of pivotal importance to understand how they are incorporated in the host crystal lattice in order to limit their uptake.

We address the topic of lactose purification by cooling crystallization, a well-established process in the dairy industry. In aqueous solution, lactose undergoes an intramolecular reaction leading to two diastereomers, alpha- and beta-lactose, that slowly interconvert until equilibrium: the reaction is called mutarotation. Below 93 °C, alpha-lactose is the least soluble compound and is traditionally recovered as monohydrate via seeded batch cooling crystallization [1,2], after an initial concentration step by evaporation. Beta-lactose is known to influence the crystallization kinetics by acting as a nucleation and growth rate inhibitor [1] whereas acidic impurities arising in the upstream cheese making process are easily incorporated in the crystal lattice. They make commercial lactose powder more acidic than similar sugars and have been reported to be a strong growth rate inhibitor [3].

The objective of this work is to reduce the unexplained variability in lactose crystallization outcome through the development of a mechanistic model that relies on particle size distribution data, the impurity incorporation rate and a recently developed chromatographic protocol to monitor the composition of a lactose solution [4,5]. A pre-treatment step to remove acidic impurities before seeded-batch supersaturation experiments is critically evaluated as part of an optimal policy to improve lactose recovery and end-product quality.

- [1] A.H.J. Paterson (2017): **Lactose processing: From fundamental understanding to industrial application**, *Int. Dairy J.* 67, 80-90.
- [2] E. Simone, A.I.I. Tyler, D. Kuah, X. Bao, M.E. Ries, and D. Baker (2019): **Optimal Design of Crystallization Processes for the Recovery of a Slow-Nucleating Sugar with a Complex Chemical Equilibrium In Aqueous Solution: The Case of Lactose**, *Org. Process Res. Dev.* 23, 220–233.
- [3] E.V. Lifran, T.T.L. Vu, R.J. Durham, J.A. Hourigan., R.W. Sleight (2007): **Crystallization Kinetics of Lactose in the Presence of Lactose Phosphate**, *Powder Technology*, 179, 43-54.
- [4] S. Trespi, M. Mazzotti (2024): **HPLC Method Development for the Quantification of a Mixture of Reacting Species: The Case of Lactose**, *J. Chromatogr. A* 1715, 464553.
- [5] S. Trespi, M. Mazzotti (2024): **Kinetics and Thermodynamics of Lactose Mutarotation through Chromatography**, *Ind. Eng. Chem. Res.* 63, 12, 5028-5038.



Importance of Seed Design to Crystallization-Induced Deracemizations

Sjoerd W. van Dongen^{1*} and Willem L. Noorduin^{1,2**}

¹AMOLF, Amsterdam, the Netherlands;

²Van 't Hoff Institute for Molecular Sciences, University of Amsterdam,
Amsterdam, the Netherlands

* vdongen@amolf.nl, ** noorduin@amolf.nl

Keywords: chirality, crystallization of organic molecules, deracemization, seed crystals

Obtaining enantiomerically pure compounds is a critical challenge for pharmaceutical industry, given over 90% of newly marketed drugs are chiral [1]. Traditional synthetic methods, however, often yield racemic mixtures, while asymmetric syntheses require expensive chiral catalysts or reagents or are limited in scope. Pasteur's demonstration of preferential crystallization has opened up a simple and scalable route for the resolution of chiral compounds that crystallize as conglomerates (i.e. enantiomerically pure crystals of left- and right-handed molecules). A subsequent breakthrough by Viedma demonstrated full deracemization of NaClO₃ through grinding [2]. Viedma Ripening, along with similar processes based on temperature cycles (TCID) or solvent cycling, has been extended to organic molecules and exhibits yields of up to 100% (as compared to 50% for separation), thereby showing great promise for the development of industrial scale crystallization-induced deracemization processes [3-5]. Seeding is a critical part of crystallization processes that can greatly determine their outcome and the significance of the purity and composition of the seed crystals that kickstart the deracemization processes has been established [6, 7]. So far, however, the deliberate design of these seed crystals remains underexplored. Here, we systematically study how design parameters such as size, shape, surface properties and crystal structure affect the crystallization-induced deracemization process. We show that rational seed design can greatly enhance the deracemization kinetics, while an unfortunate choice of seed crystals could potentially lead to racemization rather than deracemization. As such effects will be more pronounced with larger scale, these findings are crucial for industrial-scale implementation of crystallization-induced deracemizations.

- [1] L.A. Nguyen, H. He and C. Pham-Huy (2006): **Chiral Drugs: An Overview**, *Int. J. Biomed. Sci.*, 2, 85–100.
- [2] C. Viedma (2005): **Chiral Symmetry Breaking During Crystallization**, *Phys. Rev. Lett.*, 94, 065504.
- [3] W.L. Noorduin, T. Izumi, A. Millemaggi, M. Leeman, H. Meekes, W.J.P. van Enckevort, R.M. Kellogg, B. Kaptein, E. Vlieg and D.G. Blackmond (2008): **Emergence of a Single Solid Chiral State from a Nearly Racemic Amino Acid Derivative**, *JACS*, 130, 1158–1159.
- [4] K. Suwannasang, A.E. Flood, C. Rougeot and G. Coquerel (2013): **Using Programmed Heating–Cooling Cycles with Racemization in Solution for Complete Symmetry Breaking of a Conglomerate Forming System**, *Cryst. Growth Des.*, 13, 3498–3504.
- [5] S. W. van Dongen, I. Baglai, M. Leeman, R. M. Kellogg, B. Kaptein and W. L. Noorduin (2023): **Rapid deracemization through solvent cycling**, *Chem. Commun.*, 59, 3838–3841.
- [6] F. Zhang, B. Shan, Y. Wang, Z. Zhu, Z. Yu and C. Y. Ma (2021): **Progress and Opportunities of Seeding Technique in Crystallization Processes**, *ORPD*, 25, 1496–1511.
- [7] S. W. van Dongen, I. Ahlal, M. Leeman, B. Kaptein, R. M. Kellogg, I. Baglai and W. L. Noorduin (2023): **Chiral Amplification through the Interplay of Racemizing Conditions and Asymmetric Crystal Growth**, *JACS*, 145, 436–442.



In-Situ studies of Crystallization and Filtration processes using Time-Resolved synchrotron based X-Ray Phase Contrast Imaging (XPCI)

O. V. Towns^{1,2}, A. Alshukri¹, N. Hennessy¹, T. Mahmud¹, J. Leng³, S. Ottoboni^{2,4}, C. J. Price^{2,4}, H. Wheatcroft⁵, A. Jawor-Baczynska⁵, S. L. M. Schroeder^{1,2}

¹Chemical and Process Engineering, University of Leeds, Leeds, LS2 9JT, UK, ²EPSRC Centre for Innovative Manufacturing in Continuous Manufacturing and Crystallisation, University of Strathclyde, Glasgow, G1 1RD, UK, ³School of Computer Science, University of Leeds, Leeds, LS2 9JT, UK, ⁴Department of Chemical and Process Engineering, University of Strathclyde, Glasgow, G1 1RD, UK, ⁵Chemical Development, Pharmaceutical Technology & Development, Operations, AstraZeneca, Macclesfield, UK

Introduction: Synchrotron X-ray phase contrast imaging (XPCI) allows rapid microscopic imaging of multiphase systems that have otherwise low X-ray absorption contrast, such as organic crystals in solvents. This permits time-resolved studies of the structural evolution of dynamic systems. This technique has now been applied to both crystal population analysis, using 2D radiographic imaging, and to filtration processes, using 3D tomography scans.

Crystal Growth Radiography: Synchrotron based XPCI was used to image glycine cooling crystallizations in real-time with high frame rates (100 Hz) and similar resolution to conventional microscopic imaging probes (~1 μm). This method has some advantages over standard microscopic monitoring: Due to the parallel X-ray beam, all crystals in the imaged volume are resolved, minimizing the influence of out-of-focus crystals obscuring the foreground or background, making automatic processing easier compared to optical imaging techniques. There is scope to pair this technique with other X-ray modalities, e.g. dual imaging and diffraction (DIAD). Finally, 3D information can be obtained from a single 2D XPCI image [1], so crystal populations can be tracked through time in 3 dimensions, which can be used to inform more accurate 3D population balance models (PBMs). A software package that automatically detects crystals in an XPCI video and extracts information on the crystal population size with respect to time in 2-dimensions has already been created, with the intention to extend this study into 3 dimensions using Paganin filtering [1].

Filtration Tomography: Synchrotron based XPCI was also used to image filtration processes using 3-dimensional tomography. Exposure time for low absorbing mediums (such as organic API inorganic solvent) using standard laboratory tomography equipment is too long for dynamic, *in-situ*, studies to take place. The short exposure times gained by using synchrotron phase contrast imaging allowed for scans to take place in under a minute, rather than multiple hours, enabling *in-situ* 3D imaging of filtration, washing, and drying processes. Parameters were varied such as API size and shape, washing solvent, filtration endpoint, and drying rate. Scans were taken throughout each process and are analogous to frames in a video, but in 3-dimensions. Each phase in a scan can be separated and analysed. With the data collected more insights can be made into each process step, and important information such as impurity retention can be investigated.

References:

[1] Paganin D. et al. (2002) *Journal of Microscopy*, 206, 1, 33 - 40.



Integration of Deep Learning and 3D CFD-PBM Model for Characterizing $\text{Mg}(\text{OH})_2$ Precipitation

A. Raponi¹, D. Marchisio^{1*}

¹Politecnico di Torino, Institute of Chemical Engineering, Department of Applied Science and Technology, 10129 Torino, Italy

*daniele.marchisio@polito.it

Keywords: Deep learning, CFD, Precipitation

Contemporary research in reactive crystallization processes involves a multitude of phenomena spanning various scales. Notably, supersaturation is generated at the micro-scale due to chemical reactions. This heightened supersaturation level directly triggers primary nucleation and molecular growth (molecular processes) and indirectly leads to irreversible agglomeration (a secondary process). Modelling these phenomena requires assuming a functional form (kernel) and tuning the fitting parameters appropriately (eight in this contribution).

The most prevalent methodology for simplified models involves executing a multivariate optimization routine that identifies the optimal parameter set by comparing model predictions with experimental targets (e.g., characteristic sizes from Number Size Distributions). A randomly chosen initial point (or a swarm of initial points) is subjected to a local minimum search through an optimization method (such as conjugate gradient).

However, a simplified eight-parameter model reveals a plethora of local minima, making the optimization problem highly dependent on the initial candidate and, on the other hand, it becomes practically impossible to perform for 3D models. In this contribution, the authors propose an innovative, quick-responsive procedure that provides a data-driven model for computationally expensive 3D models employing Neural Networks. Initially, a Computational Fluid Dynamics (CFD) - Population Balance Model (PBM) describing the precipitation in a T-mixer (Figure 1) was employed to generate the numerical dataset. Solving partial differential equations, the CFD-PBM model associates parameter sets and operational conditions (e.g., initial concentrations of reactants) with corresponding sizes.

Subsequently, a Deep Learning Neural Network (DLNN) was trained using the dataset above, with the input-output order reversed: sizes and concentrations were given as input, and the parameter set was the output. Experimental sizes at five concentrations were then provided to the trained DLNN, and the predicted mean parameter set was tested with the 3D model. The resulting set successfully reproduced the experimental data to infer parameters and predict diameters in a Y-mixer. Furthermore, uncertainty in parameters was quantified and depicted in Figure 2.

This innovative approach attests to the effectiveness of integrating 3D CFD-PBM models and deep learning techniques to precisely and responsively characterize reactive crystallization processes. It paves the way for a deeper understanding and more optimized design of reactive crystallization processes.

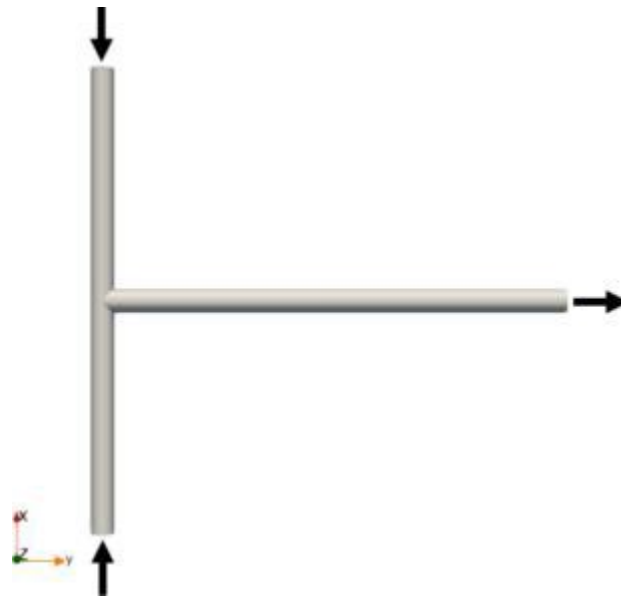

T-mixer system used to produce experimental data for the machine learning model

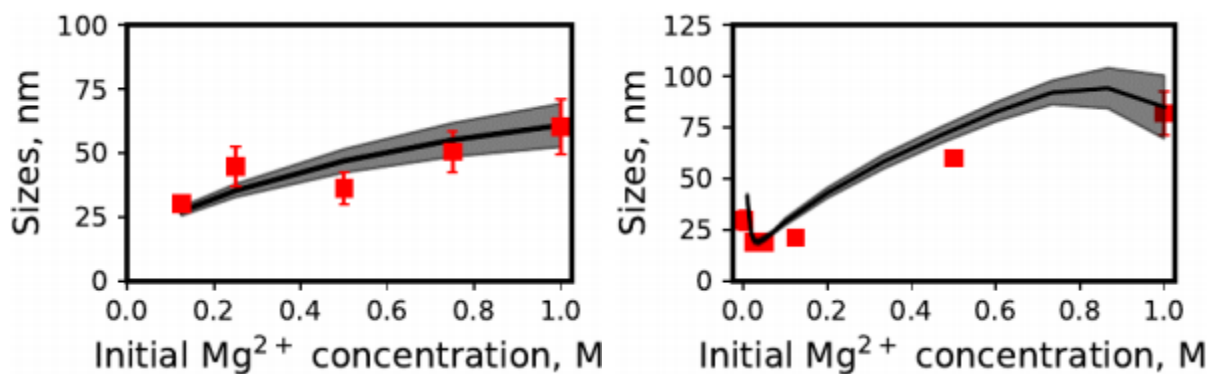

Experimental data vs numerical predictions: solid line refers to the average trend and the grey zone refers to the confidence interval

Acknowledgements

This project has received funding from the European Union's Horizon 2020 research and innovation programme under Grant Agreement No. 869467 (SEArcularMINE). This output reflects only the author's view. The European Health and Digital Executive Agency (HaDEA) and the European Commission cannot be held responsible for any use that may be made of the information contained therein. Computational resources were provided by HPC@POLITO, a project of Academic Computing within the Department of Control and Computer Engineering at the Politecnico di Torino (<http://www.hpc.polito.it>).



New insights into the solubilization of multicomponent crystals: a case study of pipemidic acid

Chuanhua Wu¹, Na Wang^{1,2}, Ting Wang^{1,2}, Xin Huang^{1,2}, Ying Bao^{1,2} and Hongxun Hao^{1,2*}

¹ School of Chemical Engineering and Technology, State Key Laboratory of Chemical Engineering, Tianjin University, Tianjin 300072, People's Republic of China;

² The Co-Innovation Center of Chemistry and Chemical Engineering of Tianjin, Tianjin University, Tianjin 300072, People's Republic of China.

* hongxunhao@tju.edu.cn

Keywords: Multicomponent crystals; Solubilization; intrinsic dissolution rate; Structure characteristics; Molecular dynamic simulation

Abstract:

Multicomponent crystals have been proven to be an effective strategy for tuning the dissolution property of pharmaceutical^[1,2]. As one of the most prominent medications of the second generation of quinolones with broad-spectrum antibacterial activity, the therapeutic effect of pipemidic acid (PPA) has been seriously underestimated due to its low solubility^[3, 4], short half-life^[5], poor efficacy and numerous side effects. In response to these issues, some new multicomponent crystals of PPA were successfully synthesized based on crystals screening using salicylic acid (SAA), gentian acid (GA), protocatechuic acid (PCA), caffeic acid (CAA) and saccharin (SAC) as cofomers, and fully characterizations on the crystal structures,

morphology, solubility, stability, etc., were performed. Single crystal structure analysis (SCXRD) combined with solid-state carbon nuclear magnetic resonance spectra (ssNMR) confirmed that proton transfer occurred between PPA and the five cofomers at room temperature, resulting in the formation of salts. Differential scanning calorimetry (DSC) analysis and variable temperature single crystal structure analysis (VT-SCXRD) confirmed the existence of interconverting polymorphism in the PPA-GA system. The solubility and the in vitro dissolution test of the multicomponent crystals shows that all the multicomponent crystals exhibit advantages such as increased solubility and decelerated intrinsic dissolution rate, compared with the pure PPA crystals, which can lead to the release of the multicomponent crystals at a slower rate, thus improving bioavailability. In additionally, all multicomponent crystals exhibited excellent stability over 8 weeks at accelerated storage conditions (40 °C and 75% RH). Further exploration of the solubilization mechanism of multi-component crystals was conducted using molecular simulation techniques, and the results indicate that the solubilizing effect is caused by the lower lattice energy and full exposure of hydrophilic groups. Hirshfeld Surface (HS) analysis showed that compared with PPA trihydrate, the contribution of the strong interactions in the multicomponent crystal structure to maintain the crystal structure tended to be weakened, indicating that the multicomponent crystal may increase the apparent solubility of PPA. Moreover, unlike cyclic supramolecular synthons in other multicomponent crystals from structure point, the synthons in PPA-SAA salts are chain-like, which may be one of the main reasons for the most significant increase in its apparent solubility. In summary, this work demonstrates that multicomponent crystals can offer a promising potential to slow the release rate and enhance the solubility for these defective pharmaceuticals.

- [1] Shan, N.; Zaworotko, M. J., **The role of cocrystals in pharmaceutical science**, *Drug Discovery Today*, 13 (9-10), 440-446.
- [2] Shaikh, R.; Singh, R.; Walker, G. M.; Croker, D. M., **Pharmaceutical cocrystal drug products: an outlook on product development**, *Trends Pharmacol. Sci.* 39 (12), 1033-1048.
- [3] Zhang, C.-L.; Wang, Y., **Aqueous solubilities for ofloxacin, norfloxacin, lomefloxacin, ciprofloxacin, pefloxacin, and pipemidic acid from (293.15 to 323.15) K**, *J. Chem. Eng. Data*, 53 (6), 1295-1297.
- [4] Pancani, E.; Menendez-Miranda, M.; Pastor, A.; Brisset, F.; Bernet-Camard, M.-F.; Desmaële, D.; Gref, R., **Nanoparticles with high payloads of pipemidic acid, a poorly soluble crystalline drug: drug- initiated polymerization and self-assembly approach**, *Acta Pharm. Sin. B*, 8 (3), 420-431.
- [5] Li, B.; Deng, Q.; Lv, J.; Zhang, Z., **Homogeneous chemiluminescence system in neutral and near neutral aqueous solution with ClO₂ as oxidant and its analytical application**. *Anal. Chim. Acta*, 560 (1-2), 128- 133.

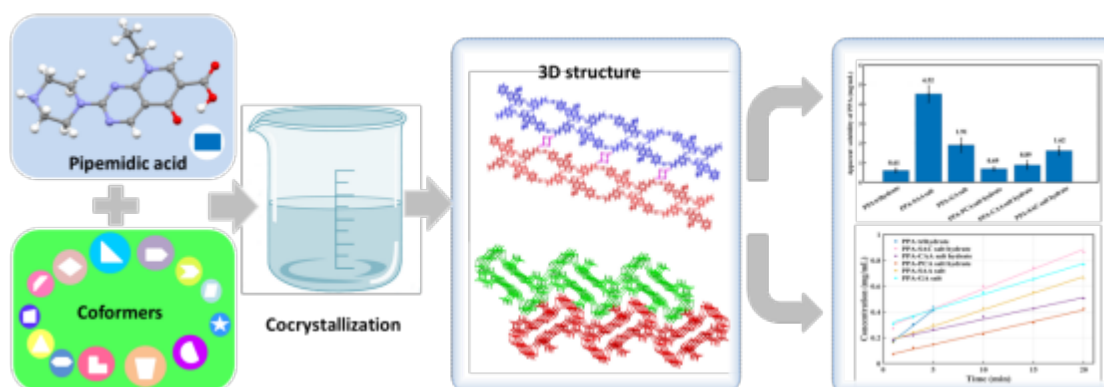

Potential of Eutectic Freeze Crystallization for Lithium-Containing Boron Extraction Waste Stream

Emek Yüksek¹, Mert Sarıkaya¹, Fatma Elif Genceli Güner¹*

¹Istanbul Technical University, Chemical Engineering Department, Istanbul, Turkey;
*gencelie@itu.edu.tr

Keywords: Eutectic Freeze Crystallization, sodium chloride, lithium, boron, recovery

One of the critical components of green energy is lithium. However, lithium resources have a noticeable scarcity due to the rapid development and broad use of automotive lithium-based batteries. These challenges have made the manufacturing, recovering, and recycling of lithium significantly difficult [1]. Similarly, boron and its derivatives play a vital role in modern industry, finding extensive use in the nuclear, chemical, electronics, pharmaceutical, glass, and ceramic sectors [2]. In this context, Eutectic Freeze Crystallization (EFC) emerges as a beacon of hope. EFC is a concentrated brine stream separation technology that can sort aqueous solutions into pure water and pure salt without the need for any extra solvent, all in an energetically favorable way.

This study considers the waste of liquid-liquid boron extraction from continental brines containing Li, B, Na, Ca, Mg, K, Cl, and SO₄. The waste solution was prepared synthetically according to the recipe [3], and the possibility of its treatment via EFC technology was investigated. EFC was carried out in a 1-liter crystallizer in a cold room that can be lowered to -45°C. Batch experiments were performed with a gradual decrease of the coolant set temperature up to -33 °C with a cooling rate of 4 °C/hour. Temperature data from 2 different points of the crystallizer were monitored online. The onset of the eutectic point (EP) was detected by a sudden jump in the temperature profile and visualized by ice and salt crystal formation. The first EP was recorded at -23.5 °C. Optical microscope pictures of produced salt and ice are presented in Fig 1. a-b. The XRD analysis further characterized salt crystals. ICP- OES analysis of the solution samples collected every 15 minutes lets us report the aqueous stream's behavior upon cooling and concentration change due to crystallization (Fig 2. a-b). Up on cooling further and concentrating gradually, the system's approach for crystallizing the following salt, especially the lithium and boron salts formation, is expected to be investigated. EFC is a remarkable separation process for converting waste into economic and ecological value. It was previously applied to many discarded solutions. These preliminary results prove the potential to treat the lithium-containing boron extraction waste stream via EFC.

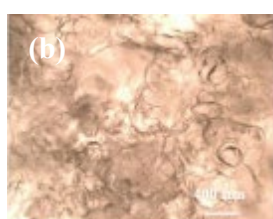
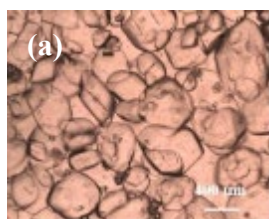

Fig. 1 Microscopic image of (a) salt (b) ice

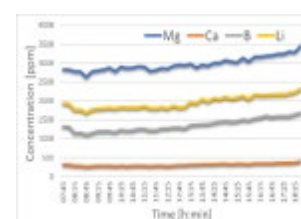

Fig. 2 Ion concentrations of (a) Na, K (b) Mg, Ca, B, Li

- [1] Lu, M., Shao, L., Yang, Y., & Li, P. (2023). *Ind. Eng. Chem. Res.*, 62(3), 1508-1522.
[2] Akbarkermani, M.R. & Genceli Guner, F.E. (2023). *Chemical Papers*, 77(10), 5881-5891.
[3] A.F. Kiemde, A.F., Marin, J., Flexer, V. & Chagnes, A. (2023), *RSC Adv.*, 2024,14, 2170-2181



Probing the nature of the crystal-solution boundary layer: an experimental campaign studying secondary nucleation from nuclei breeding

L. De Vrieze¹ and S. Kuhn^{1*}

¹ KU Leuven, Department of Chemical Engineering, 3001 Leuven, Belgium

*simon.kuhn@kuleuven.be

Keywords: Fluid shear, secondary nucleation (nuclei breeding), solute clustering

Over the last decades, the call for a method to tightly control critical quality attributes such as polymorphism and chirality during solution crystallization has only become stronger. To achieve the current level of control, companies usually rely upon seeding. Although seeding generally leads to crystals with the required properties, few instances are reported of unwanted polymorph/enantiomer formation which can render an entire crystallization batch worthless.

It is generally agreed that the most dominant mechanism for crystal proliferation in industrial conditions is secondary nucleation [1]. Despite its importance, the working mechanism still remains unknown. Intuitively, attrition is the best explanation for secondary nucleation: impact can break off small crystalline pieces of the seeds. However, the formation of the undesired crystal polymorph/enantiomer hints at another secondary nucleation mechanism, coined nuclei breeding by the scientific community [2]. Contrary to attrition, in nuclei breeding the new crystals are assumed to form in the crystal-solution boundary layer and thus do not necessarily have the same nature as the seed crystal. A better fundamental understanding of nuclei breeding and the nature of this crystal-solution boundary layer will lead to better crystal product control.

In this work, innovative experiments were designed to specifically study nuclei breeding. Polythermal nucleation experiments (0.1°C/min cooling rate) were conducted in temperature-controlled 20 mL well-stirred vials containing a stagnant tethered crystal of NaClO₃ in water. Since special attention was paid to eliminating attrition/contact and initial breeding, fluid shear was the acting nuclei removal mechanism. Interestingly, reference experiments for primary nucleation were here for the first time performed using a 3D printed object of the same shape as a real crystal, assuring that shear rates for nuclei breeding and primary nucleation were the same. Polarization microscopy was applied to analyze the nature of the newly formed crystals.

Although similar works noticed a clear distinction in nucleation rate (also from polythermal experiments) between primary nucleation and nuclei breeding [3], the distinction between both was here found to be less clear. Moreover, the chirality of the formed crystals in experiments with tethered seed crystals was measured to be around 50/50 *l*-NaClO₃/*d*-NaClO₃, indicating that the seed crystal does not dominate the crystal product chirality for nuclei breeding.

- [1] J. Hoffmann et al. (2022): **The Unexpected Dominance of Secondary over Primary Nucleation**, Faraday Discuss., vol. 235, pp. 109-131.
- [2] J. Anwar, S. Khan, and L. Lindfors (2015): **Secondary Crystal Nucleation: Nuclei Breeding Factory Uncovered**, Angew. Chemie Int. Ed., vol. 54, no. 49, pp. 14681-14684.
- [3] M. Yousuf and P. J. Frawley (2018): **Experimental Evaluation of Fluid Shear Stress Impact on Secondary Nucleation in a Solution Crystallization of Paracetamol**, Cryst. Growth Des., vol. 18, no. 11, pp. 6843-6852



Process Development for Recovery of Lithium Carbonate from a Battery Recycling Process

S. Musholt¹, and A. Jupke^{1*}

¹AVT.FVT - Fluid Process Engineering, RWTH Aachen University, Aachen,
Germany

*andreas.jupke@avt.rwth-aachen.de

Keywords: Lithium carbonate precipitation, battery recycling, process development

As energy storage devices for mobile and stationary applications, lithium-ion batteries (LIBs) have long become part of our everyday lives. Production capacities for LIBs are being significantly expanded due to the ever-increasing global demand. The recovery of raw materials from end-of-life LIBs and their return to the production process is therefore of great importance for the long-term security of raw materials in Europe. Particular attention is being paid to the elements lithium and cobalt, as well as natural graphite, which are incorporated in LIBs. Due to their limited availability and economic importance, these three materials have been declared critical raw materials by the EU.

In commercial LIB recycling processes, the elements from the LIB cathode - including lithium and cobalt - are made accessible for recovery in subsequent wet chemical process steps by mechanically crushing the LIBs and dissolving them in acid. Recovery as salts then takes place in a combination of liquid-liquid extraction and precipitation processes. Due to the high selectivity of these process steps with respect to the polyvalent cations, the monovalent lithium is usually recovered in the last process step. The lithium can be precipitated as a lithium carbonate salt by adding a saturated sodium carbonate solution. An alternative approach to recovering lithium as a lithium carbonate salt is to fumigate the lithium containing solution with carbon dioxide. For example, waste gas streams can be used as a source of carbon dioxide. If too much carbon dioxide is added to the lithium-containing solution, the pH is lowered to such an extent that the carbonate is converted to hydrogen carbonate. This results in a product loss of solid lithium carbonate. This means that controlling the process is very important here.

The investigations discussed in this article are aimed at the design and implementation of a continuous lithium precipitation process. The central objective is to achieve a high purity of the lithium carbonate produced with the highest possible yield. As part of these investigations, the species present during the process are quantified and the influence of the initial composition on the yield is investigated. Both artificial and real material systems are used for this purpose. Due to the high tendency of lithium carbonate to agglomerate, the supersaturation in the process should be controlled in the future by suitable measurement variables. Based on the knowledge gained about the influence of process conditions on the particle size distribution, the particle size distribution will then be specifically adjusted.



Simultaneous and Sequential Precipitation from Lithium-Ion Batteries (LIBs) Recycling Process

A. Mazur¹, C. R. Souza², F. M. Penha^{1*}

¹ Department of Chemical Engineering, KTH Royal Institute of Technology, Stockholm, Sweden,

² Department of Mining Engineering, UFMG Federal University de Minas Gerais, Belo

Horizonte, Brazil.

* frempe@kth.se

Keywords:

simultaneous precipitation, oxalates, lithium carbonate, resource recovery, process intensification.

The EU Raw Materials Initiative identifies 34 critical raw materials essential for Europe's technological advancement, including lithium, cobalt, nickel, and manganese, crucial for battery production in the transition to clean energy. Addressing their recovery from secondary sources (recycling) is imperative for sustainable practices and a circular economy. Despite existing methods, the recycling of lithium-ion batteries (LIBs) could benefit from intensified methods to close the material loop. State-of-the-art is heavily based on solvent extraction, which, while effective, shows drawbacks regarding energy consumption and time expenditure, particularly in separating the materials required for subsequent steps. Here, we explore the simultaneous precipitation to recover metals from synthetic a LIB liquor, akin to NMC precursors, using oxalic acid. The precipitation process was simulated in OLI Stream Analyzer, to assess oxalate addition in simultaneous and fractional precipitation processes. 1M oxalic acid was added at once to recover Ni, Co and Mn, whilst for the fractional processes, first 0.3M oxalic acid was added to recover Ni and Co and subsequently additional 0.7M oxalic acid was used to recover the majority of Mn and remaining traces of Ni and Co. Experimental results show cobalt and nickel recovery to be circa 98% in both precipitations. In contrast, manganese recovery falls short compared to simulations, reaching 27.5% in simultaneous and 32% in fractional precipitation, when the expected recovery was 79.9%. Lithium recovery, unanticipated in simulations, reached 11.4% in simultaneous and 5.7% fractional precipitation methods. The solids recovered were calcinated at 900°C for 24h, while the remainder of Li content in the exhausted liquor was recovered through carbonate precipitation and the solid analyzed by microscopy optical and SEM-EDS, FTIR and XRD. To recover lithium, a pretreatment for pH adjustment from the exhausted liquor was made with the addition of 2M Ca(OH)₂. This allowed the optimization of lithium recovery while simultaneously reducing the sulfate content of the system by gypsum precipitation. Sodium carbonate (2.5M) is then added to the system and lithium carbonate recovery is expected to reach up to 70% in this setup. This process allowed the recovery of all main components from the LIB liquor by carefully tailoring precipitation processes based on thermodynamic simulations.



The deployment of 2D population balance modelling to optimise particle processability in pharmaceutical crystallisation processes

O. L. Watson^{1*}, A. Jawor-Baczynska¹

¹Chemical Development, Pharmaceutical Technology & Development, Operations,
AstraZeneca, Macclesfield, UK;

[*oliver.watson1@astrazeneca.com](mailto:oliver.watson1@astrazeneca.com)

Keywords: Population Balance Modelling, Crystallisation, Optimisation

With the vast majority of pharmaceutical drug products delivered to patients in solid form, the conveyance and processing of crystalline solid material is inevitable during pharmaceutical production, and with it: a raft of technical challenges. Unlike the relative simplicity of solution-based operations, the transferral of solid particles around a manufacturing plant requires the utilisation of chutes, silos, conveyors and, commonly, other mechanical intervention; a high level of flowability in crystalline drug products is essential for a robust manufacturing process. Indeed, poor control of the particle size and shape can lead to complications in downstream unit operations, such as the blocking of filters or the formation of powder structures over hoppers and chutes – particularly challenging for continuous tableting operations (e.g., roller compaction, continuous direct compression).

That said, initial development is often undertaken in the pursuit of high crystal yield and purity, and reducing solvent usage, with less attention given to powder properties and the impact of those quality attributes on downstream processing – prohibitive time, material and resource constraints inherent in laboratory work mean additional control of crystal size and shape is required down the line. Conventionally, additional unit operations are introduced to this end, aiming to reduce crystal aspect ratio and limit the volume of very small particles – ‘fines’ – present in the bulk powder. Particles can be milled to reduce their size and aspect ratio, however such processes can be challenging to control and risk the generation of fines which adversely affect the physical properties of the API. Hence, temperature cycling is regularly employed in concert – this recrystallisation process will preferentially dissolve smaller crystals during heating, whilst larger particles have the potential to grow during cooling. A fine balance between these two techniques is critical; with further mechanical intervention frequently necessitated during secondary processing to disrupt powder structures. Beside the increased risk of batch-to-batch variation or failure due to this added complexity, particle size reduction operations are highly inefficient and energy intensive; those concerned with sustainable manufacturing practices should strive to eliminate these highly inefficient procedures.

We employ 2D population balance modelling in gPROMS as a tool to model crystal growth and nucleation kinetics of unfavourable particle morphologies, incorporating bulk property models – conceived primarily for drug product – to develop greater holistic understanding. The impact of seeding strategy, cooling rates and temperature cycling on critical quality attributes (particle size, shape and flowability) is investigated via mathematical optimisation and design space exploration, to then guide experimentation towards a highly effective crystallisation process. Moreover, this assists in the understanding of the crystallisation design space, as well as providing a model to guide scale-up for API production in the future.



Towards sustainability in industry: PET recycling approaches on an industrial scale

L. Marc^{1*}, M. Schwiderski¹, M. Stepanski¹, and E. Temmel¹

¹ Sulzer Chemtech Ltd, Neuwiesenstrasse 15, CH-8401 Winterthur, Switzerland

*laureline.marc@sulzer.com

Keywords: PET recycling; separation technologies; sustainable industry

Worldwide plastics annual production reached an all-time high of more than 450 mt in 2019 of which around 25 mt can be attributed to polyethylene terephthalate (PET) [1]. This versatile material is widely applied in automotive, packaging, or medical industry [2], for example, but is mainly known from thin-walled containers for beverages and from fibers [3]. Fibers and bottles represent a large source for microplastic, hence, environmental contamination, if the waste is not managed appropriately.

In Europe, a good collection rate of PET waste is reached for bottles, around 73% in 2020 [4]. Subsequently, mainly mechanical recycling is applied to regenerate the PET before it is sent back into goods production. The drawback is a downcycling of the material, or loss of plastics quality, which leads eventually to a final disposal or incineration of the PET. To utilize also this feed stock, chemical recycling can be applied, which degrades the polymer into its monomers. This facilitates a purification before repolymerization and, hence, allows for high PET product qualities. But only an economically and energetically reasonable process will be applied in large-scale and lead towards a true circular economy.

To date, two processes are mature enough to be close to their industrial realization: PET methanolysis and glycolysis. While the first involves poisonous methanol, the obtained product, dimethyl terephthalate (DMT), can be easily purified by distillation-crystallization combinations. The achievable qualities allow for a virgin or food-grade PET quality after a hydrolysis from DMT to TPA [5]. On the other hand, the glycolysis involves only non-hazardous ethylene glycol (EG) to produce bis(2-Hydroxyethyl) terephthalate (BHET), which can be repolymerized directly. Due to these advantages, several industries are searching for a competitive process to purify BHET, especially if other materials are present in large quantities in the glycolysis feedstock like in fibers.

Crystallization can be applied as a first recovery of BHET from the mixture after depolymerization reaction. It usually provides a very good separation efficiency with lower energy consumption compared to distillation. In this contribution, three different crystallization methods will be compared, namely layer-forming, cooling and anti-solvent suspension crystallization, on the basis of their resulting yield, productivity and ability to remove ethylene glycol and other impurities. Other technologies will also be evaluated regarding their potential in terms of separation and refinement. Based on these results, an indication for the most reasonable BHET production and purification process can be given.

- [1] <https://ourworldindata.org/plastic-pollution>, consulted on 03.05.2024. Cited sources: Geyer et al. (2017); OECD (2022)
- [2] V. Dhaka *et al.* (2022): **Occurrence, toxicity and remediation of polyethylene terephthalate plastics. A review.** *Environ. Chem. Lett.* 20, 1777-1800.
- [3] S. Kumartasli, and O. Avinc (2020): **Important Step in Sustainability: Polyethylene Terephthalate Recycling and the Recent Developments.** In: Muthu, S.S., Gardetti, M.A. (eds) *Sustainability in the Textile and Apparel Industries. Sustainable Textiles: Production, Processing, Manufacturing & Chemistry.* Springer, Cham.
- [4] Systemiq (July 2023): **Circular PET and Polyester. A circular economy blueprint for packaging and textiles in Europe.** <https://www.systemiq.earth/pet-polyester/>, consulted on 10.11.2023.
- [5] C. Pudack, M. Stepanski, P. Fässler (2020): **PET Recycling-Contributions of crystallization to sustainability.** *Chem. Ing. Tech.* 92(4), 452-458.

Understanding the Effect of Screw Design on Continuous Particle Isolation Performance within the Continuous Vacuum Screw Filter

M. Meier, H. Bettin, and K. Wohlgemuth*

TU Dortmund University, Dortmund, Germany;

*kerstin.wohlgemuth@tu-dortmund.de

Keywords: continuous particle isolation; small-scale production; high-quality products; pharmaceuticals; continuous vacuum screw filter

Approximately 90 % of all active pharmaceutical ingredients (APIs) are obtained in crystalline form. Due to the increasing demand for continuous small-scale manufacturing processes (250 - 1000 kg a⁻¹), the development of continuous small-scale manufacturing equipment for particle generation and isolation is required. The patented modular Continuous Vacuum Screw Filter (CVSF) for continuous particle isolation combines the unit operations filtration, washing, and drying in one flexible apparatus.

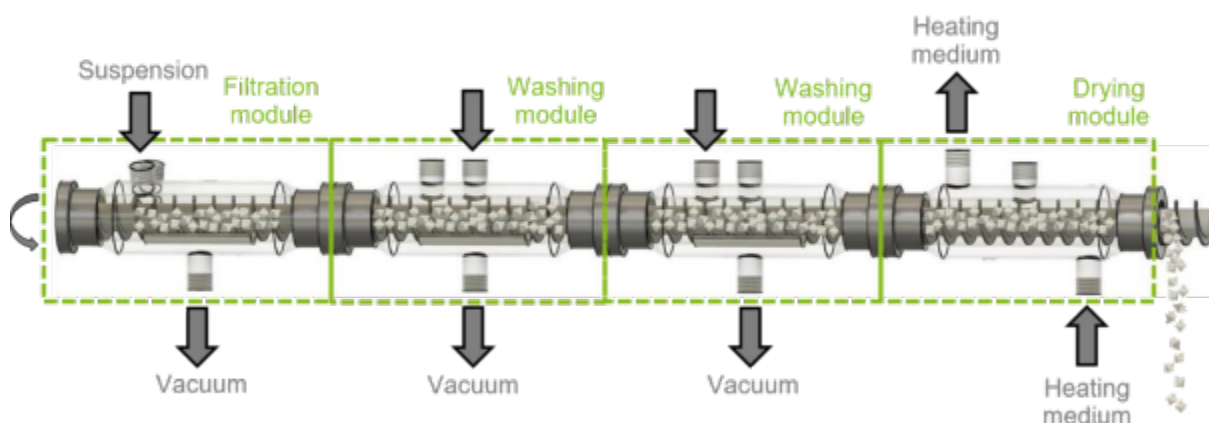

Figure 1: Exemplary setup of the CVSF consisting of one filtration module, two washing modules and a drying module. Grey arrows mark the main material flows.

As depicted in Figure 1, the CVSF consists of two main elements: a variable number of tubular modules connected via flanges and a screw. The modular setup enables, depending on the individual module design, a flexible process design by combining modules for filtration, washing, and drying. Thus, the CVSF setup can be flexibly adapted to different material systems or operating parameters. Furthermore, the rotating screw provides a gentle axial transport of the product particles due to low rotation frequencies, ensuring the preservation of particle specifications during the continuous particle isolation process in the CVSF. The apparatus is continuously fed with crystal suspension through an inlet in the first filtration module. By applying vacuum to the module, the mother liquor is removed through the porous filter medium located at the lower half of the tubular body. In the subsequent washing modules wash liquid is distributed on the wet particles via washing nozzles, while the liquid is simultaneously removed from the filter cake through a porous filter medium by applying vacuum. The drying module is equipped with a tempered double jacket allowing further reduction of residual moisture, if needed, in order to ensure dry, free-flowing particles with a residual moisture below 1 %. [1]

Previous studies have shown that a filling degree of 50 % in the CVSF is essential for optimal performance of the CVSF process. The filling degree is influenced by the inlet crystal suspension volume flow rate, solid loading, and rotational screw speed for a fixed screw design. Since the crystal suspension volume flow rate and solid loading are predefined by the preceding crystallization process within a continuous crystal process chain, the only degree of freedom to adjust the filling degree is the rotational screw speed. [1].

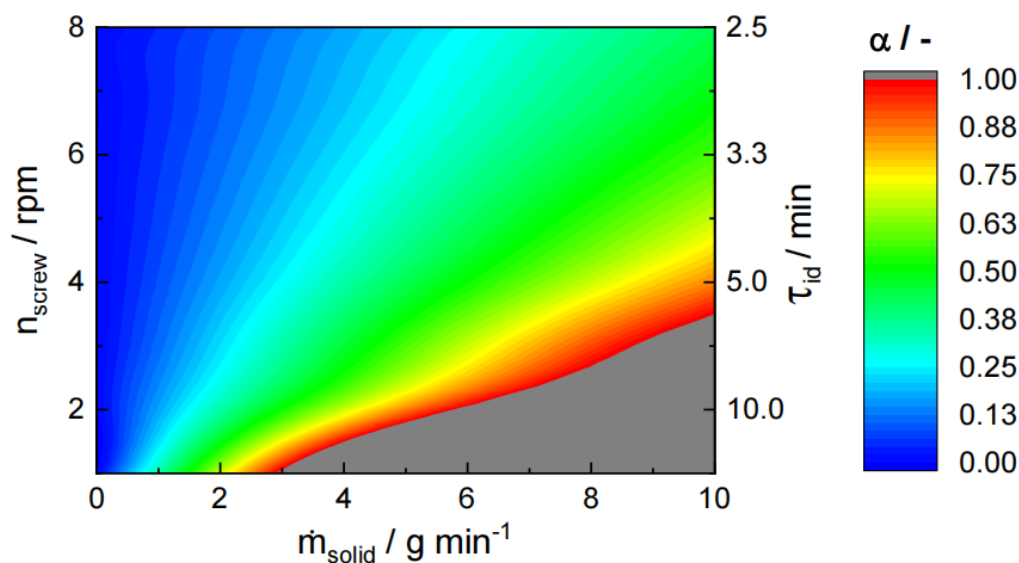

Figure 2: Filling degree α as function of rotational screw speed n_{screw} (first y-axis) and solid mass flow rate m_{solid} (x-axis) at fixed screw design. The mean ideal residence time τ_{id} (second y-axis) is calculated based on n_{screw} and the screw design. [1]

However, the screw design provides a further degree of freedom in order to increase the flexibility of the CVSF. By varying design parameters of the screw, like shaft diameter D_i and pitch distance P , the filling degree and residence time in the CVSF can be adjusted independently of the crystal suspension volume flow rate and solid loading. The results of various screw designs with respect to process performance using aqueous L-alanine suspensions as model system will be presented.

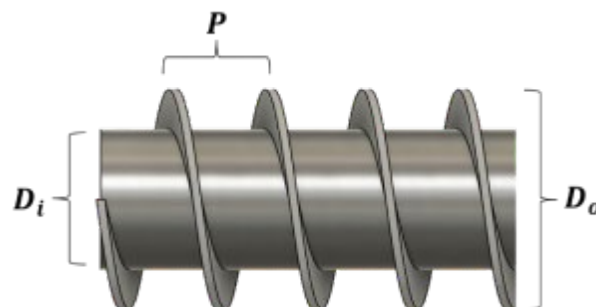

Figure 3: Schematic screw design with shaft diameter D_i , pitch distance P , and outer diameter D_o .

[1] C. Steenweg, A.I. Seifert, G. Schembecker, K. Wohlgemuth (2021): **Characterization of a Modular Continuous Vacuum Screw Filter for Small-Scale Solid-Liquid Separation of Suspensions**, *Org. Process Res. Dev.* 25, 926-940.



Using CO₂ to precipitate MnCO₃ for a lithium-ion battery precursor

T.Sibanda¹, S.Mgabhi¹, J.Chivavava¹ and A.E. Lewis^{1*}

¹Univeristy of Cape Town, CapeTown, South Africa

*Alison.Lewis@uct.ac.za

Keywords:

Lithium-ion batteries, carbonate precipitation, manganese, CO₂ gas

South Africa has the world's largest reserves of manganese (Mn), and it is predicted that demand will significantly increase as Mn is a core requirement in new generation electric vehicle batteries.

High Purity Manganese, also known as battery grade manganese, is needed in the form of High Purity Manganese Sulphate Monohydrate (HPMSM), MnSO₄·H₂O. However, producing HPMSM from the Mn ore is conventionally achieved using electrowinning to recover Mn from the leachates, followed by redissolution of the recovered Mn metal in sulphuric acid. This process is energy intensive, hence has a large carbon footprint and its own technical challenges. This study explored an alternative, novel method of recovering Mn from leach liquors via precipitation. This involves precipitation of MnCO₃ using a carbonate source, in order to separate the Mn from the impurities in the leach liquor. This pure carbonate salt can then be dissolved and recrystallized as HPMSM. Existing work on precipitation of MnCO₃ from waste liquors has used ammonium bicarbonate (ABC) as the carbonate source^[1].

An added advantage of this route is that there is potential to use CO₂, a major greenhouse gas, as the carbonate source, saving costs as well as designing a more environmentally friendly process.

Although these concepts have been tested in low-grade waste streams^[1-3], only partial success has been achieved and the concept has not yet been applied to manganese salt production from leach liquors of primary ores.

The first phase of the research project was a desktop study, to develop a conceptual process design; to identify operating conditions and to generate an overall material balance for a potential CO₂ precipitation process. This phase was carried out using the thermodynamic modelling package OLI Stream Analyser^[4] which uses the revised Helgeson-Kirkham-Flowers (HKF) model for the calculation of standard thermodynamic properties of aqueous species and the frameworks of Bromley, Zemaitis, Pitzer, Debye-Hückel, and others for the excess terms. The thermodynamic modelling investigated the following scenarios:

1. Effect of pH on CO ₂ solubility
2. Effect of pH on theoretical Mg, Mn and Ca yields.
3. Effect of pressure on CO ₂ solubility with pH control at pH = 6.6
4. Effect of pressure on yield of MnCO ₃ at a range of pH values

The modelling showed that the theoretical yield of MnCO₃ using CO₂ is at least equivalent to that using ammonium bicarbonate (ABC). The modelling successfully identified the necessary pH conditions for optimum dissolution of CO₂, maximum precipitation of MnCO₃ and minimum co-precipitation of Mg and Ca. This condition is $6.6 < \text{pH} < 7.9$.



The second phase was a bench scale laboratory study to develop a CO₂-based precipitation process on the laboratory scale with accompanying conceptual design. In this stage, the kinetic

effects (which cannot be modelled using the desktop thermodynamic software) were examined. The focus here was on:

- a. Establishing the effect of using gaseous CO₂ as a precipitant on the recovery and purity of the produced MnCO₃ salt.
- b. Establishing the effect of CO₂ pressure on the recovery and purity of the product.

A bench scale laboratory reactor with pH control and CO₂ sparger designed for optimum gas liquid mass transfer was successfully commissioned and operated. A CO₂-based precipitation process with an accompanying conceptual design was developed at the laboratory scale. This process generated kinetic information (i.e., the effect of reaction time) and showed that increasing the run time significantly affected the yield, from 4% at one hour to 94% at 11 hours. Increasing the CO₂ pressure to 2 barg significantly improved the kinetics, with a yield of 72% at 1 hour run time.

The process resulted in the rejection of Mg and Ca of 99 and 98%, respectively, from the product. Thus, high purity MnCO₃ product was obtained after washing which showed that Mn was selectively recovered from a leach liquor containing both Ca and Mg impurities.

- [1] Lin, Q.-q., et al., *Separation of manganese from calcium and magnesium in sulfate solutions via carbonate precipitation*. Transactions of Nonferrous Metals Society of China, 2016. **26**(4): p. 1118-1125.
- [2] Yu, C., et al., *A novel approach for recovery of manganese from on-site manganese-bearing wastewater*. Journal of Cleaner Production, 2019. **227**: p. 675-682.
- [3] Wang, N., et al., *Recovery of soluble manganese from electrolyte manganese residue using a combination of ammonia and CO₂*. Hydrometallurgy, 2016. **164**: p. 288-294.
- [4] OLI Systems Inc, *OLI Studio Stream Analyzer, v11.5 (Build 1.7) 15-Sep-2022*. Morris Plains, New Jersey, 2022.



Posters



Content of Abstract for Posters

A.P.1.	A predictive approach to recover solvent and lost APIs from mother liquor.....	33
A.P.2.	A Simplified Analytical Model for the Impurity Heating Hypothesis of Laser-Induced Crystal Nucleation	34
A.P.3.	Aggregation of <i>rac</i> -Na-Ibuprofen-2H ₂ O with or without silica.....	35
A.P.4.	AI for development of solid salt hydrates for thermal energy storage	36
A.P.5.	Antisolvent Crystallization of Polymorphs of DL-Methionine.....	38
A.P.6.	Anti-solvent crystallization from a deep eutectic solvent for recycling of lithium-ion batteries augmented with computational density functional theory (DFT).....	39
A.P.7.	Application of Real-Time In-Process Image Derived Particle Size & Count, Polarization Vision, & Dispersed Phase Signal Enhanced Raman for Faster, Deeper Process Understanding of Crystallization.....	40
A.P.8.	Behaviors of Fluid Inclusions in Dicumyl Peroxide single crystals versus.....	41
A.P.9.	Characterization and Selective Crystallization of Curcuminoids.....	43
A.P.10.	Continuous Crystallization of carbamazepine dihydrate using a Fluidic Oscillator as a Mixing Device	44
A.P.11.	Cooling Crystallization of NaB(OH) ₄ for hydrogen production in NaBH ₄ hydrolysis recycle systems.....	46
A.P.12.	Cooling crystallization of potassium niobate in aqueous medium.....	47
A.P.13.	Crystallization Process Design at Servier: A Case Study.....	48
A.P.14.	Crystallization-based separation studies of L-homophenylalanine from a biocatalytic reaction system - Fundamental studies	49
A.P.15.	Current view on solid-state deracemization by temperature-cycling	50
A.P.16.	Data Uncertainty within the Small-Scale Crystallisation DataFactory	51
A.P.17.	Deep Learning Enhanced Correlation of Particle Descriptors to Sustainable Pharmaceutical Manufacturing Processes	52
A.P.18.	Effect of impeller diameter on crystallization kinetics in borax sonocrystallization under pulsed ultrasound irradiation	53
A.P.19.	Effects of Ultrasound on Reactive Crystallization and Particle Properties of an Aromatic Amine in Batch and Continuous modes	54
A.P.20.	Evaporative crystallization of sessile droplets using electrowetting.....	55



A.P.21.	Feasibility of Data-Driven Model to Predict Crystallisation Induction Time.....	56
A.P.22.	Importance of Seed Design to Crystallization-Induced Deracemizations.....	57
A.P.23.	Influence of processing conditions on the industrial crystallisation and crystal morphology of iron (II) sulphate heptahydrate.....	58
A.P.24.	In-Situ Studies Of Crystallization And Filtration Processes Using Time-Resolved Synchrotron Based X-Ray Phase Contrast Imaging (Xpci)	59
A.P.25.	Laser induced nucleation emerging from interaction of thermocavitation bubble pairs	60
A.P.26.	Magnetics and Turbulence: a macroscopic pathway to novel crystallization	61
A.P.27.	Mechanism of leaching and antisolvent crystallization of spent lithium-ion batteries in ascorbic acid system.....	63
A.P.28.	Melting properties of L-homophenylalanine revealed from Fast Scanning Calorimetry ..	64
A.P.29.	Metastable Zone Width and Growth Kinetics of Soda Ash Hydrates in the Na ₂ CO ₃ -NaOH-H ₂ O System	65
A.P.30.	Multi-Label Detection of Crystallization Phenomena Using In-Situ Imaging and Deep Learning	66
A.P.31.	Non-linear and Two-level Modell Predictive Controller Design to CMSMPR Crystallizer.....	67
A.P.32.	Novel materials and directed crystal engineering for continuous Eutectic Freeze Crystallization (EFC).....	69
A.P.33.	Polymorphic change induced by secondary nucleation in single-seed crystallizations with gamma glycine.....	71
A.P.34.	Recovery of Ni, Co and Mn methane sulfonate hydrates by liquid antisolvent crystallization and eutectic freeze crystallization	73
A.P.35.	Salt screening of racemic and Ibuprofen with inorganic bases.....	74
A.P.36.	TiNb ₂ O ₇ formation through a simple precipitation route	75
A.P.37.	Using CO ₂ to precipitate MnCO ₃ for a lithium-ion battery precursor.....	76
A.P.38.	Water purification in a freeze concentration process	78



A.P.1. A predictive approach to recover solvent and lost APIs from mother liquor

Yusuf Khan^{1,2*}, Chris J. Price^{1,2}, Scott Brown^{1,2}, Jan Sefcik^{1,2} and Anna Jawor-Baczynska³

1 Department of Chemical and Process Engineering, University of Strathclyde, United Kingdom G1 1XQ

2 CMAC Future Manufacturing Hub, University of Strathclyde, United Kingdom G1 1RD

3 Chemical Development, Pharmaceutical Technology & Development, Operations, AstraZeneca, Macclesfield, UK

*yusuf.khan@strath.ac.uk

Keywords: Crystallization, API Recovery, Mother Liquor Recycling

Sustainability has recently become a crucial consideration, particularly in pharmaceutical crystallization, which is the focus of this study. The mother liquor resulting from the crystallization process contains not only crystallization solvents and impurities but also dissolved valuable active pharmaceutical ingredients (APIs) that have the potential for recovery. Due to its impurity content, this mother liquor is often regarded as a waste stream and its reuse in the process could lead to an accumulation of impurities, potentially affecting the purity of the final API product. Previous studies have shown that the level of impurity buildup eventually stabilizes after a certain number of recycling cycles, dependent on the fraction of mother liquor recycled [1,2]. In our current work, we first developed a predictive model in Aspen that quantifies the impurity buildup in the mother liquor based on the fraction recycled in a batch process. This model was subsequently validated through experimental methods. The mother liquor was recycled multiple times, and assays were conducted to determine API concentration and impurity buildup at each cycle, comparing these values against the simulation predictions. Both the model and experimental results generally conformed to those of earlier studies [1,2], demonstrating that recycling 60% of the mother liquor can reduce the amount of API needed per cycle by 40% while maintaining a consistent yield.

Given the enhanced efficiency, cost-effectiveness, and flexibility of continuous processes [3], we extended our study to develop a continuous process model in Aspen. In this model, we concentrated the mother liquor using distillation column from the end composition of the crystallization process back to the initial API feed concentration before recycling 60% of it back into the crystallizer. This continuous process, involving both concentration and recycling, is predicted to achieve a 60% increase in yield compared to conventional processes without recycling. We explored a range of concentration endpoints to evaluate their potential in maximizing API recovery from the mother liquor. Further, we aim to incorporate the use of gPROMS to predict the properties of the APIs across different process topologies and assess the impact of impurity buildup on the APIs in each scenario. This "predict first" approach allows us to establish a theoretical baseline, which we then validate through experimental work. This study will provide promising strategy for the pharmaceutical industry, significantly reducing environmental impact while maintaining product quality.

[1] Smith, A.A. (1997) 'A model for mother liquor recycle in batch processing', *Organic Process Research Development*, 1, 165–167.

[2] Keshavarz, L., Steendam, R.R. and Frawley, P.J. (2018) 'Impact of mother liquor recycle on the impurity buildup in crystallization processes', *Organic Process Research Development*, 22, 1541–1547.

[3] Patrascu, M. and Barton, P.I. (2019) 'Optimal Dynamic Continuous Manufacturing of pharmaceuticals with Recycle', *Industrial Engineering Chemistry Research*, 58, 13423–13436.



A.P.2. A Simplified Analytical Model for the Impurity Heating Hypothesis of Laser-Induced Crystal Nucleation

P. van Tooren¹, H.B. Eral^{1*}

¹Delft University of Technology, Delft, The Netherlands;

*h.b.eral@tudelft.nl

Keywords: Crystallization, Laser-Induced Nucleation, Impurity Heating Mechanism.

Crystallization is an important process in chemical and pharmaceutical industry[1, 2, 3]. One of the promising new crystallisation processes is called Non-Photochemical Laser-Induced Nucleation (NPLIN)[4]. Non-Photochemical Laser-Induced Nucleation (NPLIN) promises to reduce the induction time of compounds in comparison to conventional crystallisation processes. Unfortunately, NPLIN is poorly understood on a theoretical level. A potential theory is that laser light heats up small impurities present in the solution to the point that these impurities start acting like small evaporative crystallisers. This is called the Impurity Heating (IH) hypothesis. Whilst conceptually captivating, there are only few mathematical models of IH present in literature, and all of them involve many complicated equations[5, 6]. A simplified analytical model presents an opportunity for reducing the amount of independent parameters involved in the process. Furthermore it may ultimately provide a guideline for using NPLIN in crystal engineering. Using analytical mathematical methods, the physics in the governing equations of previous computational work[6] on the IH hypothesis are condensed into simplified expressions. The resulting model fits accurately to previous computational work on the concentration profile, but fits poorly with the expected temperature profile from the same simulations. The simplified model accurately reproduces the NPLIN of KCl and NaCl, as well as the finding that Sodium Chlorate does not, but fails to explain why Urea, an organic molecule, undergoes NPLIN. Potential reasons why the simplified model fails to universally accurately predict whether NPLIN will occur or not: (a) the simplified model is incomplete and the prediction of the NPLIN of compounds has to incorporate non-ideal thermodynamic behaviour and/or crystal kinetics as well. (b) the simplified model is not accurate enough to predict the correct changes in driving potentials during the cavitation event. (c) the Impurity Heating hypothesis is not sufficient to serve as a universal model of NPLIN.

- [1] Myerson (2002): **Handbook of Industrial Crystallization** (2e), *Butterworth-Heinemann: Woburn*.
- [2] Lewis, M. Seckler, H. Kramer (2015): **Industrial Crystallization: Fundamentals and Applications**; *Cambridge University Press*, Vol. 1.
- [3] M. Jehannin, A. Rao, H. Cölfen (2019): **New Horizons of Nonclassical Crystallization**. *J. Am. Chem. Soc.* 141, 10120-10136.
- [4] V. Korede, N. Nagalingam, F. Penha, N. van der Linden, J. Padding, R. Hartkamp, H. Eral (2023): **A review of laser-induced crystallization from solution**. *Crystal Growth & Design*, 23(5), 3873-3916.
- [5] N. Hidman, G. Sardina, D. Maggiolo, H. Ström, S. Sasic (2020): **Numerical frameworks for laser-induced cavitation: is interface supersaturation a plausible primary nucleation mechanism?** *Crystal Growth & Design*, 20(11), 7276-7290
- [6] N. Nagalingam, A. Raghunathan, V. Korede, C. Poelma, C. Smith, R. Hartkamp, J. Padding, H. Eral
- [7] (2023): **Laser-Induced Cavitation for Controlling Crystallization from Solution**. *Physical review letters*, 131(12), 124001



A.P.3. Aggregation of *rac*-Na-Ibuprofen-2H₂O with or without silica

Z. DELABAUDIÈRE-LE MEUR¹, W-S. KIM², P. CARDINAE¹ and G. COQUEREL¹

¹Laboratoire SMS UR 3233 – Université de Rouen Normandie – Place Émile Blondel
76821 Mont-Saint-Aignan CEDEX;

²Department of Chemical Engineering, ILRI, Kyung Hee University, Yoing Kiheung-
ku Seochun-dong 1, Kyungki-do 449-701, Republic of Korea

*zoe.delabaudiere-le-meur@univ-rouen.fr

Keywords: Ibuprofen, Flowability, Agglomeration, Couette-Taylor, Spray-Drying

Flowability of powders depends on many factors such as: particle morphology, particle size distribution, inter-particle forces, etc. Unfortunately, many active pharmaceutical ingredients (APIs), like *rac*-Na-Ibuprofen-2H₂O, (*rac*-Na-IBU hereafter) are defined as cohesive powders, impacting different steps in the drug product fabrication process. Therefore, to improve the flowability of *rac*-Na-IBU, the objective is to transform its initial plates-like crystals into particles with a rounded shape by spherical agglomeration^{1,2,5}, surface modification^{3,4} or core-shell⁶ synthesis, with or without the presence of silica, using different technologies: Mixed Tank (MT), Couette-Taylor (CT) and Spray Drying (SD).

The synthesis of core-shell particles in MT led to a heterogeneous coating of *rac*-Na-IBU around silica particles and a heterogeneous coating within the samples. A similar method transferred to a CT crystallizer failed: there was no coating and at high rpm, some silica beads were broken but there was some crystal aggregation. The results in the CT were the same with or without the presence of silica. The spherical agglomeration conducted in MT showed that it is possible to obtain *rac*-Na-IBU agglomerates. The results were better without silica, but the shape and size distribution of the aggregates were heterogeneous. Due to the utilization of two immiscible solvents, the utilization of the CT is complex, and up to now, the results are not successful. With the spray-drying technique, it is possible to obtain some spherical agglomerates of *rac*-Na-IBU without silica particles, but the presence of silica beads improves the result and uniformity.

[1] Y. KAWASHIMA *et al.* (1994): **Improvements in flowability and compressibility of pharmaceutical crystals for direct tableting by spherical crystallization with a two-solvents system**, *Powder Technol.* 78, 151- 157.

[2] N. RAVOURU *et al.* (2018): **Preparation and in vitro evaluation of ibuprofen spherical agglomerates**, *Turk. J. Phar. Sci.* 15, 7-15.

[3] T. KOJIMA, J.A. ELIOTT (2013): **Effects of silica nanoparticles on the bulk flow properties of fine cohesive powders**, *Chem. Eng. Sci.* 101, 315-328.

[4] L.J. JALLO *et al.* (2011): **Improvement of flow and bulk density of pharmaceutical powders using surface modification**, *Int. J. Pharm.* 423, 213-225

[5] J-M. KIM (2011): **Agglomeration of nickel/cobalt/manganese hydroxide crystals in CT crystallizer**, *Colloid Surface A* 384, 31-39.

[6] J. HELBIG *et al.* (2020): **Li/Mn-rich cathode materials with low-cobalt content and core-shell particle design of high-energy lithium ion-batteries**, *J. Electrochem. Soc.* 176, 060519.



A.P.4. AI for development of solid salt hydrates for thermal energy storage

A. A. Korotkevich^{1*}, S. Woutersen², N. Shahidzadeh¹, and A. Pérez de Alba Ortíz^{2,3}

¹Van der Waals-Zeeman Institute of Physics, University of Amsterdam

²Van 't Hoff Institute for Molecular Sciences, University of Amsterdam

³Informatics Institute, University of Amsterdam

*a.korotkevich@uva.nl

Keywords: artificial intelligence, thermal energy storage, salt hydrates, sustainability

More than 50% of energy consumed in buildings is for thermal end use. Hence, in view of the global energy crisis there is urgency to develop technologies that efficiently store and reuse the available heat. A promising approach addressing this challenge is based on hydration reactions of solid salts:

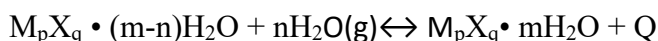

This process is reversible, hydration reaction leads to release of heat, while the dehydration is endothermic. reversible hydration reactions Such “heat batteries” have high energy densities ($>1GJ/m^3$) and are environmentally benign. However, these materials need improvement in durability and operational conditions for real-life applications. We aim to discover new promising salt hydrates and optimize their design. This design space is however quite large ($> 10^8$ reactions), making the conventional high-throughput screening unreasonable.

To approach this problem, we apply artificial intelligence. We fit machine learning models on thermochemical data for salt hydration reactions. As model input, we use reaction representations based on stoichiometry. Those simple representations are available for any hydration reaction, however they encode only limited information about the reactants. We tackle this by introducing chemical contextual awareness, similar to context attention in natural language processing. Thanks to the attention mechanism we can learn information-rich graph-like representations of salt hydrates directly from data. This way we developed models capable of predicting heat and energy density of hydration reactions with accuracies (Figure 1).

We believe that our work will benefit the community of material scientists by providing tools for smart choice of materials for experimental screening.

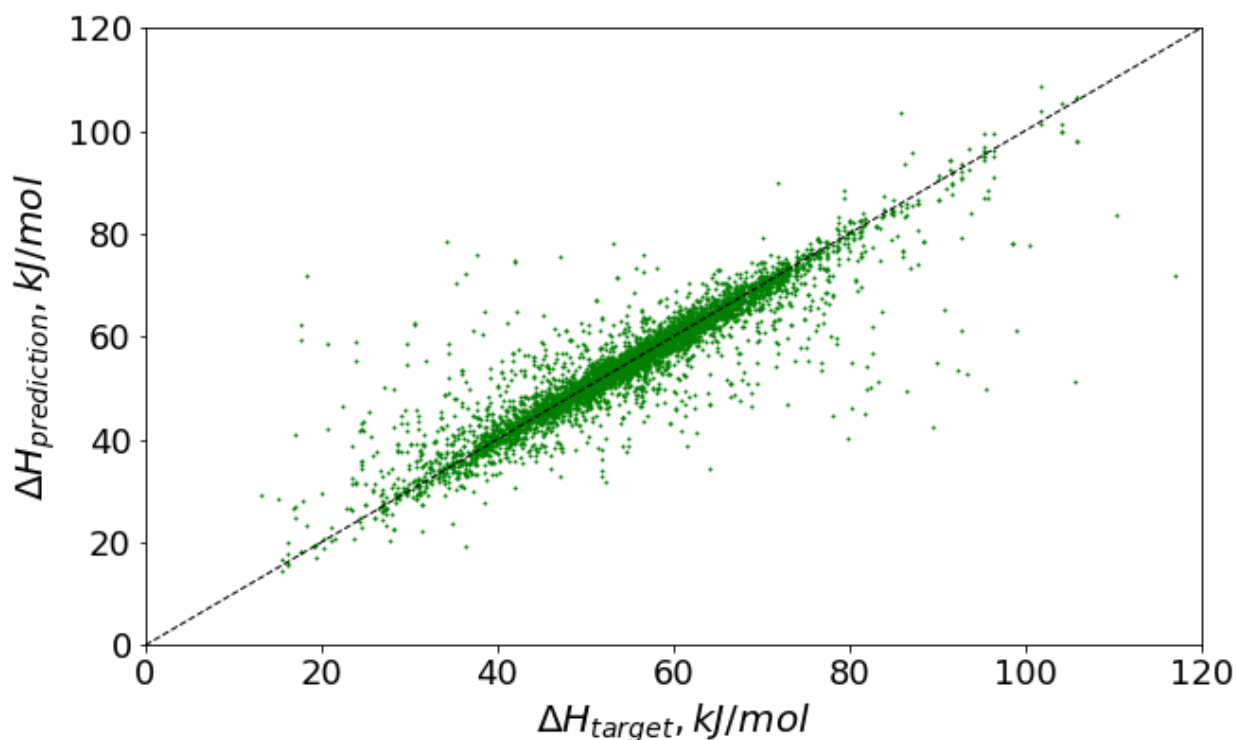

Figure 1 Result of prediction of hydration enthalpies of salt hydration reactions obtained with a machine learning model based on salt stoichiometry; mean absolute error of the prediction is 2.6 kJ/mol

References

- [1] Steven Kiyabu and Donald J. Siegel (2023) **Computational Discovery of Thermochemical Heat Storage Materials Based on Chalcogenide and Complex Anion Salt Hydrates**, *ACS Appl. Eng. Mater.*, 1 (10), 2614-2625
- [2] N.Mazur et al (2023) **Revisiting salt hydrate selection for domestic heat storage applications**, *Renew. Energy*, 218, 119331
- [3] Goodall, R.E.A., Lee, A.A. (2020) **Predicting materials properties without crystal structure: deep representation learning from stoichiometry**, *Nat Commun* 11, 6280



A.P.5. Antisolvent Crystallization of Polymorphs of DL-Methionine

L. Inthavideth and L. Wantha*

School of Chemical Engineering, Institute of Engineering,
Suranaree University of Technology, Muang District, Nakhon Ratchasima 30000,
Thailand

*lekwa@g.sut.ac.th

Keywords: Antisolvent crystallization, DL-Methionine, Nucleation rate, Polymorphs,

DL-methionine is crucial in the case of health maintenance and produced as an active pharmaceutical ingredient, a dietary supplement, in animal feed, and as a precursor for other chemicals. DL-methionine could be crystallized into three forms: α —metastable, β —stable, and γ —most stable. α and β forms normally nucleate concomitantly in the crystallization, then transform into γ , the most stable form. In this study, ethanol was selected as antisolvent, an antisolvent crystallization was carried out to nucleate the crystals and a pure form. Raman spectroscopy and Microscopy were used for identifying crystal polymorphism. α form was obtained at a high fraction of antisolvent used. A mixture of α and β form were obtained at lower fraction of ethanol. The effect of the fraction of ethanol was investigated the solubility and nucleation rate of α form. The nucleation rate at 35 °C was measured by Focus Beam Reflectance Measurement (FBRM). The solubility of α form decreased with increasing the fraction of ethanol. The nucleation rate increased with increasing the fraction of ethanol. Moreover, the particle size decreased with increasing the fraction of ethanol.



A.P.6. Anti-solvent crystallization from a deep eutectic solvent for recycling of lithium-ion batteries augmented with computational density functional theory (DFT)

S. Teimouri¹, C. Ma¹, M. Svärd¹, and K. Forsberg^{1*}

¹KTH Royal Institute of Technology, Stockholm, Sweden

*kerstino@kth.se

Keywords: Anti-solvent crystallization, Deep Eutectic Solvent (DES), Recycling, Li-ion batteries, Density Functional Theory (DFT).

The proliferation of lithium-ion batteries (LIB) necessitates environmentally-benign and efficient methods for recycling the resulting LIB waste [1]. Deep eutectic solvents (DESs) offer a promising way for LIB recycling in a closed-loop system. ADES is a eutectic mixture formed through hydrogen bonding, typically between two components where one acts as a hydrogen bond donor (HBD) and the other as hydrogen bond acceptor (HBA). DESs, which typically comprise relatively inexpensive and biodegradable compounds, have properties including non-volatility, biodegradability, easy synthesis, and does not require an extra reducing agent in the leaching process [2, 3]. This study examined five carboxylic acid based DESs for their ability to dissolve lithium cobalt oxide (LCO), a common cathode material in LIBs. After determining the best DES for extracting Li and Co from LCO, the metals are recovered through anti-solvent crystallization. Anti-solvent crystallization entails adding a water-miscible organic solvent (i.e. acetone, ethanol) to the pregnant DES solution to reduce the solubility of the solute and impose precipitation. The difference in volatility between that of the DES and that of the anti-solvent (i.e. acetone) aids their separation by evaporation, allowing for a relatively low-energy process to recover both for reuse [4].

In addition to experimentation, one can calculate the Gibbs Free Energy of reactions with density functional theory (DFT), a computational modeling technique [5]. DFT helps to predict which of the carboxylic acid based HBDs might be the most stable, and therefore likely ligand to form complexes with Li and Co. By corroborating the experimental results of this study, DFT is proposed as a complementary tool that may save time and cost of further research. DFT also provides additional insight into the studied systems, such as the optimal geometry of complexes, so as to understand reactions at a fundamental level.

[1] J. Neumann, M. Petranikova, M. Meeus, J.D. Gamarra, R. Younesi, M. Winter, S. Nowak, (2022): **Recycling of Lithium-Ion Batteries—Current State of the Art, Circular Economy, and Next Generation Recycling**, *Advanced Energy Materials*, 12, 1-26.

[2] B. Li, Q. Li, Q. Wang, X. Yan, M. Shi, C. Wu, (2022): **Deep eutectic solvent for spent lithium-ion battery recycling: comparison with inorganic acid leaching**, *Physical Chemistry Chemical Physics*, 24, 19029-19051.

[3] N. Peeters, K. Binnemans, S. Riaño, (2020): **Solvometallurgical recovery of cobalt from lithium-ion battery cathode materials using deep-eutectic solvents**, *Green Chemistry*, 22, 4210-4222.

[4] C. Ma, J.D. Gamarra, R. Younesi, K. Forsberg, M. Svärd, (2023), **Antisolvent crystallization from deep eutectic solvent leachates of $\text{LiNi}_{1/3}\text{Mn}_{1/3}\text{Co}_{1/3}\text{O}_2$ for recycling and direct synthesis of battery cathodes**, *Resources, Conservation and Recycling*, 198, 107210.

[5] S. Mohammadnejad, J. L., Provis, & J. S. J. van Deventer, (2017). **Computational modelling of interactions between gold complexes and silicates**. *Computational and Theoretical Chemistry*, 110, 113-121.



A.P.7. Application of Real-Time In-Process Image Derived Particle Size & Count, Polarization Vision, & Dispersed Phase Signal Enhanced Raman for Faster, Deeper Process Understanding of Crystallization.

Craig Callahan, Piotr Cholewa, Richard Becker*

¹BlazeMetrics, Seattle, USA;

*richard.becker@blazemetrics.com

Keywords: Process Analytical Technology, In-line microscopy, particle characterization, Raman spectroscopy

Process Analytical Technology (PAT) has dramatically expanded its capability over the last decade. Today's PAT enables an in-depth understanding of processes on both macroscopic and molecular levels, allowing scientists and engineers to accurately track the impact of process variables on system behaviour. Whether in a reactor, a continuous flow line, or a filter/dryer, kinetic mechanisms such as nucleation, growth, breakage, agglomeration, and "oiling out" play a major role in downstream drug manufacturing.

BlazePAT is being implemented all over the world from Lab to Plant in 1mm flow lines to ATEX/NFPA production vessels. It is a single probe technology incorporating Polarization Microscopy, Dispersed Phase Signal Enhanced Raman Spectroscopy, Image Analysis Derived Particle Size, Particle Count, & HDR Turbidity. Using next generation BlazePAT, these mechanisms are understood in real-time and can be related to final particle morphology, surface, size, and structure, which ultimately drive downstream processability. The application of PAT to these downstream efforts presents new opportunity for deeper process understanding and control through further steps of the drug product cycle.

In this paper I will focus on the application of Blaze technology to speed and improve the depth of understanding for an anhydrous to hydrate conversion, a Tri-Mode Crystallization, as well as controlling a process by determining in real-time a Sub-Micron milling endpoint.



A.P.8. Behaviors of Fluid Inclusions in Dicumyl Peroxide single crystals versus temperature.

L. Salgado^{1*}, F. Faure² G. Coquerel¹

¹Université de Rouen, Rouen, France ² CRPG Vandœuvre-lès-Nancy *luis-alberto.salgado-paredes@univ-rouen.fr

Keywords: FIs, shape evolution vs Temperature, Cooling rates, CO₂ concentration, Behaviors

Fluid inclusions are cavities, typically ranging from sub micrometers to millimeters in size, that form within the crystal during crystal growth. These inclusions trap fluids present during the crystal formation, providing valuable insights into the physicochemical conditions prevailing at the time of crystallization [1]. These inclusions can compromise the purity of the crystal, presenting a challenge for achieving high purity standards [1,2]. Common behavior of fluid inclusions (FIs) during heating-cooling cycles of different crystals of organic compounds has shown a change in size and morphology from a rounded shape towards a faceted shape (i.e., ‘negative crystal’) when they are heated up [2,3]. On cooling, they comeback to their original ellipsoidal shape with a gas bubble inside; this is metastable state [3,4]. Since different parameters affect the properties of fluid inclusions, it has been studied the effects of impurities on the formation of fluid inclusions and then their impacts in the fluid inclusion shape and behaviors. By contrast to this ‘classical behavior’, in Dicumyl Peroxide (DCP) some FIs can exhibit a rapid and drastic contraction with a change in curvature upon fast cooling rates. Those inclusions are transiently in a shape of a holly leaf. This phenomenon, previously undocumented, has been recently observed in olivine volcanic rocks containing an excess of CO₂. This novel observation could provide an elucidation of the mechanisms underlying the change in curvature of FIs, both in organic and geological crystals, specifically olivine rocks [5,6]. In order to reach a high density of fluid inclusions (FIs) within the crystals, the crystals were grown by slow cooling of an aqueous ethanol solution with a substantial concentration of CO₂. The FIs that exhibited hollyleaf shape upon cooling frequently contained a relatively large gas bubble, indicating the presence of an entrapped gaseous phase within the inclusions. Depending on temperature, it takes from few minutes to several days to comeback to rounded shape with an unchanged gas bubble. After along period of time a more faceted shape reappears corresponding to thermodynamic equilibrium [7,8]. This new behavior is not applicable to all FIs in DCP crystals in ethanol systems. The turn-backs of the holly leaves point the former corner of the negative crystal. In order to foster the curvature inversion phenomenon, UV radiation was employed, significantly amplifying the curvature of fluid inclusions under a rapid cooling. This observation emphasizes the crucial interplay between radiation exposure concentration of CO₂ dissolved and cooling kinetics.

[1] Bobo. Emilie, "Contribution on the formation and the behaviors of fluid inclusions in crystals.," 2016, p. 46.

[2] S. H.C, "On the microscopical structure of crystals, indicating origin of minerals and rocks.," Quart. J. Geol. Soc. London, pp. 14, 453–500.



- [3] Waldschmidt A., " **About aged heterogeneous liquid inclusions inside organic crystals in relation to crystal formation, structure and morphology.**" (2011).
- [4] R. Buso, " **Les magmas parentaux du volcanisme récent du Bas-Vivarais (Ardèche, France) : composition, conditions de genèse et origine de leur richesse en CO₂.** Doctoral dissertation," École Doctorale des Sciences Fondamentales, Université Clermont Auvergne, 2023.
- [5] R. Buso, " **High-pressure homogenization of olivine-hosted CO₂-rich melt inclusions in a piston cylinder: insight.**" *European Journal of Mineralogy*, vol. 34, pp. 8-15, 2023.
- [6] Bobo E., " **Growth rate dispersion at single crystal level.**" *Chem. Eng.* 38, pp. 1011-1016, 2015.
- [7] Bobo E., " **Evidence of Two Types of Fluid Inclusions in Single Crystals.**" *CrystEngComm* 18, p. 5287–5295, 2016.
- [8] Marc L., " **Impact of a partial solid solution and water molecules on the formation of fibrous crystals and fluid inclusions.**" *Crystals* 2021., pp. 11, 1188, doi.org/10.3390/cryst11101188 , (2021) .
- [9] Cooper J., " **Antisolvent addition : an effective method of controlled fluid inclusion formation in RDX crystals.**" *Cryst. Growth Des.*, Vols. 20, 7120–7128. , 2020.
- [10] Z. Jing, " **Formation mechanisms of liquid inclusions in Dicumyl 23, 4551-4562.**" *CrystEngComm*, pp. 23, 4551-4562. , 2021.
- [11] Z. L. Hou, " **Measurement and correlation of solubility and thermodynamic properties of dicumyl peroxide (DCP) in pure and binary solvents.**" School of Chemical Engineering, Tianjin University], 2021.
- [12] F. Tissandier L., " **A new heating stage for high temperature/low pO₂ conditions. J.**" *Cryst. Growth* 458, 72-79. , vol. 458, pp. 72-79. , (2017).
- [13] T. Ulrich, " **Crystalline coats or hollow crystals as tools for product design in pharmaceutical industry.**" *J. Cryst. Growth*, vol. 362, pp. , 235-237. , 2021.



A.P.9. Characterization and Selective Crystallization of Curcuminoids

L. Lamkowski¹, M. F. Gutiérrez¹ and H. Lorenz¹ *

¹Max Planck Institute for Dynamics of Complex Technical Systems, Magdeburg,
Germany

*lorenz@mpi-magdeburg.mpg.de

Keywords: Curcuminoids, separation, solid-state forms, solubility, UNIFAC

The turmeric plant (*Curcuma longa* L.) is valued as a functional food and is associated with health-promoting properties such as anti-inflammatory, anti-oxidant, anti-microbial, anti-cancer, and many more. The extract of the plant contains three bioactive components, namely curcumin, demethoxycurcumin (DMC), and bisdemethoxycurcumin (BDMC). Commercially available curcumin is usually a ternary mixture, with BDMC and DMC contents of up to 10% and 25% respectively. While curcumin is the most extensively studied curcuminoid, DMC and BDMC have not received much attention. Some studies revealed different biological activities for the individual curcuminoids, leading to the assumption that DMC and BDMC are pharmaceutically relevant ingredients [1]. Thus, their separation is of general interest. In previous projects, a seeded cooling crystallization approach was studied to isolate curcumin [2], and BDMC was investigated regarding its various solid-state forms [3].

The aim of this work is to separate BDMC and DMC via crystallization to provide them in higher quantities. Therefore, we characterized the pure compounds via thermal analysis, nuclear magnetic resonance, X-ray diffraction and spectroscopy techniques, including inline spectroscopy. Furthermore, in a solvent screening approach, we synthesized and characterized three multicomponent solid-state forms of DMC. For a separation process, solubility data in the curcumin, BDMC and the DMC/solvent system were obtained experimentally. These data were used to assess the capabilities of both the UNIFAC and modified UNIFAC (Dortmund) models in predicting the solubilities of the curcuminoids in different solvents. Based on the results of these studies, we present and discuss preliminary separation strategies.

- [1] Amalraj, A. Pius, S. Gopi, S. Gopi (2017): **Biological activities of curcuminoids, other biomolecules from turmeric and their derivatives - A review**, *J. Tradit. Complement. Med.* 7, 205-233.
- [2] E. Horosanskaia, L. Yuan, A. Seidel-Morgenstern, H. Lorenz (2020): **Purification of Curcumin from Ternary Extract-Similar Mixtures of Curcuminoids in a Single Crystallization Step**, *Crystals* 10, 206.
- [3] S. Wünsche, A. Seidel-Morgenstern, H. Lorenz (2022): **Cocrystallization of Curcuminoids with Hydroxybenzenes Pyrogallol and Hydroxyquinol: Investigations of Binary Thermal Phase Behaviors**, *Cryst. Growth Des.* 22, 3303-3310.



A.P.10. Continuous Crystallization of carbamazepine dihydrate using a Fluidic Oscillator as a Mixing Device

V. Honavar¹, R. G. Ellis², N. Nere², and V. V. Ranade^{1*}

¹Multiphase Reactors and Intensification Group, University of Limerick, Ireland;

² Small Molecule CMC Process Engineering, AbbVie Inc., North Chicago, IL, USA

*Vivek.Ranade@ul.ie

Keywords: Anti-solvent crystallization, fluidic devices, population balance modelling

The pharmaceutical industry is rapidly evolving the prevailing crystallization systems to achieve better control over the critical quality attributes of the Active Pharmaceutical Ingredient (API) produced.^[1] Fluidic devices can provide superior mixing and scalability compared to conventional crystallizers, while also facilitating control of the particle size distribution (PSD).^[2] Fluidic oscillators are devices without moving parts that utilize jet oscillations to display enhanced mixing, heat and mass transfer. In this study, we investigated the use of fluidic oscillator for the anti-solvent crystallization of carbamazepine dihydrate (CBZ-DH) from ethanolic solutions using water as an antisolvent. Following Pandit and Ranade^[3], a loop setup was used for the operation of the fluidic oscillator (augmented with a helical coil) as a continuous crystallizer. The performance of the loop setup in terms of the PSD of the acicular crystals (measured using the SOPAT imaging probe) and the yield was benchmarked against the performance of a continuous stirred tank crystallizer (CSTC) and a continuous oscillatory baffled crystallizer (COBC) operating at the same supersaturation ratio and residence time. The experiments were modelled using 1D population balance models and the kinetic parameters of secondary nucleation and growth were estimated by fitting the predicted PSD and concentration profiles to the corresponding experimental profiles, for different cases. The experimental data obtained from the loop setup by varying initial supersaturations (1.5 and 3) and residence times (6, 12 and 24 minutes) was used to evaluate the model. The validated model was used to investigate sensitivity of different operating parameters (supersaturation, residence time, temperature etc.) on key performance indicators (PSD, yield, productivity). The residence time and supersaturation were found to be key factors influencing performance. Increasing the residence time at a constant initial supersaturation, resulted in larger particles and higher yield up to a certain limit. The initial supersaturation influences the overall yield of the process without affecting the PSD. This study supports the potential of the fluidic oscillator as a mixing device for anti-solvent crystallization applications and lays the foundation for multi-dimensional modelling of anti-solvent crystallization of CBZ-DH in fluidic devices.

- [1] Nagy, Z.K., et al., *Recent advances in the monitoring, modelling and control of crystallization systems*. Chemical Engineering Research and Design, 2013. **91**(10): p. 1903-1922.
- [2] Madane, K. and Ranade, V.V., *Anti-solvent crystallization: Particle size distribution with different devices*. Chemical Engineering Journal, 2022. **446**.
- [3] Pandit, A.V. and Ranade, V.V., *Fluidic oscillator as a continuous crystallizer: feasibility evaluation*. Industrial & Engineering Chemistry Research, 2020. **59**(9): p. 3996-4006.

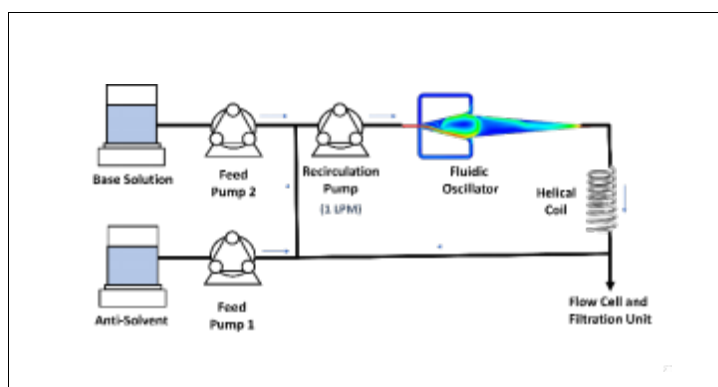

Figure 1. The loop setup for continuous containing the fluidic devices (fluidic oscillator and helical coil)

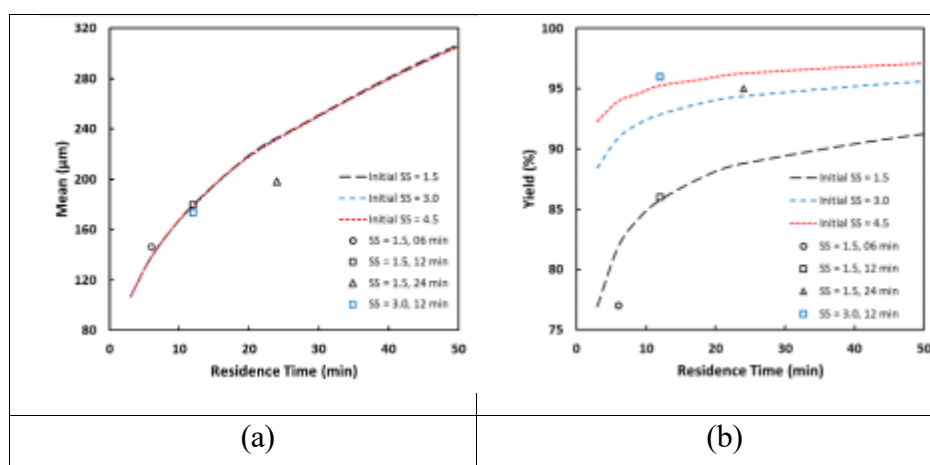

Figure 2. Plot of (a) mean (in micron) of the PSD and (b) yield obtained over a range of residence times at different supersaturations (lines represent simulated data and symbols represent experiments)

Disclosures:

R. G. Ellis and N. Nere are employees of AbbVie and may own AbbVie stock. AbbVie sponsored and funded the study, contributed to the design, participated in the collection, analysis, and interpretation of data, and in writing, reviewing and approval of the final publication.



A.P.11. Cooling Crystallization of $\text{NaB}(\text{OH})_4$ for hydrogen production in NaBH_4 hydrolysis recycle systems.

J. R. T. Postma^{1*}, M. van der Vooren, A. Wijnands, H. B. Eral¹, J. T. Padding¹.

¹ Complex Fluid Processing, Process & Energy Department, Faculty of Mechanical Engineering, Delft University of Technology, Leeghwaterstraat 39, 2628 CB Delft,

The Netherland;

*J.R.T.Postma@tudelft.nl

Keywords: Crystallization, Cooling, Growth, Hydrogen, Nucleation.

The energy transition from fossil fuels to hydrogen as a fuel is becoming more of a reality every day. Especially in the maritime sector will this transition have a significant impact on the green-house-gas (ghg) emissions. One group of these hydrogen fuels is the hydrogen carriers of which NaBH_4 is one of the most promising. NaBH_4 reacts with water in an exothermic reaction producing hydrogen gas and $\text{NaB}(\text{OH})_4$. To ensure a safe and constant supply of fuel to the maritime vessel a continuous addition of NaBH_4 and removal of $\text{NaB}(\text{OH})_4$ is required. To make this a continuous process a recycle system is set-up, consisting of a hydrolysis reactor and $\text{NaB}(\text{OH})_4$ crystallizer. For the design of the crystallizer in such a recycle system, detailed data on solubility, nucleation rate and crystal growth of $\text{NaB}(\text{OH})_4$ is required. In this work we validate the solubility of $\text{NaB}(\text{OH})_4$ and the effects of NaBH_4 on the solubility of $\text{NaB}(\text{OH})_4$, which are found to have little effect on the solubility of $\text{NaB}(\text{OH})_4$ in the 34-53 wt% range. For nucleation we looked into homogeneous nucleation in a supersaturation concentration ratio between 1.2-3.2 at 293 K and 1.2-2.5 at 303 K and found no visible nucleation of $\text{NaB}(\text{OH})_4$ crystals in 1.5 mL aqueous solution of $\text{NaB}(\text{OH})_4$ after 3 days. After changing the conditions to no stirring and 295 K, an additional 4 weeks did not provide consistent crystallization (1/20 samples showed visible crystals). We measured crystal growth using seeded cooling crystallization without stirring. 6 seeds are added to a 30 mL aqueous solution of $\text{NaB}(\text{OH})_4$ at 295 K and a consistent crystal growth is observed on the added seeds.



A.P.12. Cooling crystallization of potassium niobate in aqueous medium

C. R. Souza^{1*}, F.M. Penha² and S. D. F. Rocha¹

¹Universidade Federal de Minas Gerais, Belo Horizonte, Brazil;

²KTH Royal Institute of Technology, Stockholm, Sweden

*cassiasouza@ufmg.br

Keywords: potassium niobate, cooling crystallization, physicochemical characterization

Potassium niobate as the most stable phase – KNbO_3 – is a perovskite-type compound and its crystalline structure depends on the temperature of synthesis, which can be cubic, tetragonal, rhombic, and orthorhombic. In alkaline medium, Nb(V) forms Lindqvist-type ions $\text{H}_x\text{M}_6\text{O}_{19}^{(x-8)}$ (M= metal) and the formation of the cluster M_6O_{19} is related to the formation of hexaniobate salts $\text{H}_x\text{Nb}_6\text{O}_{19}^{(x-8)}$ [1]. The synthesis of potassium niobate has been studied by several methods, such as the sol-gel, microwave-assisted solvothermal, and hydrothermal methods. Only a few studies are reported using precipitation [2] and crystallization [3] methods. Depending on the synthesis path, the niobates crystallization could involve the formation of metastable phases which are later converted to the most stable phase. In this context, we have investigated the crystallization of potassium niobate at atmospheric temperature and pressure from the alkaline leachate of the Fe-Nb alloy fines. Experimentally, atmospheric cooling crystallization of potassium niobate was carried out from the alkaline liquor, after a pre-concentration step through evaporation. The initial concentration of niobium in the liquor of 1.0, 1.1 and 1.3 M – based on pre-concentration steps of 20, 40 and 60 wt% of water removal, respectively – and cooling rate – 0.1, 0.5 and 1.0 °C/min – were evaluated to understand their influence on the crystallization of potassium niobate, mainly in the form (stable/metastable), particle morphology, size, and size distribution of the particles. The solids were characterized by XRD, FTIR and microscopy. The chemical composition of the solutions was obtained through ICP- OES. The XRD of synthesized potassium niobate shows the presence of two dominant phases KNbO_3 and $\text{K}_4\text{Nb}_6\text{O}_{17}$. The liquor pre-concentrated at 40 wt% water removal shows to be the better option to crystallizing potassium niobate, considering the extension of reaction and energy consumption. It was observed that an increase in the cooling rate of crystallization led to a decrease in niobium consumption from the solution, i.e., less solid phase was formed. After cooling, the solution was kept at 30 °C and under agitation for 24 hours. Within the first hour, 7%, 28% 29% of niobium was consumed from the initial solution at cooling rates 1.0, 0.5 and

0.1 °C/min, respectively. After 24 hours, niobium consumption reached 12%, 46% and 82%, respectively. These results are essential to developing scientific and technological knowledge about niobium in aqueous media, which is scarce in the literature. Therefore, this study not only reports an alternative method of niobium recovery but also proposes the obtention of potassium niobate from secondary sources.

[1] G. J. P. Deblonde et al. “Experimental and computational exploration of the UV-visible properties of hexaniobate and hexatantalate ions,” *RSC Adv.*, vol. 5, no. 10, pp. 7619–7627, 2015, doi: 10.1039/c4ra14866e.

[2] R. Komatsu, K. Adachi, and K. Ikeda, “Growth and characterization of potassium niobate (KNbO_3) crystal from an aqueous solution,” *Japanese J. Appl. Physics, Part 1 Regul. Pap. Short Notes Rev. Pap.*, vol. 40, no. 9 B, pp. 5657–5659, 2001, doi: 10.1143/jjap.40.5657.

[3] X. Wang, S. Zheng, H. Xu, and Y. Zhang, “Leaching of niobium and tantalum from a low-grade ore using a KOH roast-water leach system,” *Hydrometallurgy*, vol. 98, no. 3–4, pp. 219–223, 2009.



A.P.13. Crystallization Process Design at Servier: A Case Study

B.Schammé¹, M.Schindler¹, D.Baltes¹, and M.Paugam,^{1*}

¹ORIL Industrie - Servier, Chemical & Analytical Development, Bolbec, France

[*mikael.paugam@servier.com](mailto:mikael.paugam@servier.com)

Keywords: Crystallization, Polymorphism, Industrial feasibility

In the field of industrial crystallization, design of crystallization process for active pharmaceutical ingredient (API) meets requirements and challenges.

The most relevant parameter will be the industrial feasibility which includes not only the yield and the chemical product quality but also the physical product quality such as process control, crystalline form (polymorphism, stability, and crystal shape), productivity, filterability, etc.

In this way, different research axes are involved in the crystallization process design such as (i) polymorph and solvate screening, (ii) solubility screening, (iii) characterization and stability studies.

These studies will make it possible to rate each crystalline form, in term of industrial feasibility, and to choose the best one for the further development of the API. Following which, a well- controlled crystallization process must be designed for the desired crystalline form.

This study presents the development of a crystallization process for an API from Servier presenting different polymorphic forms (salt, hydrate, anhydrous and solvate). Study of relative stabilities and solubilities led to design phase diagram helping to develop the robust crystallization process meeting the requirements of industrial processability. Indeed, while the hydrate form was the most stable one and chose as the form to develop, a new solvate appears in DMSO during the solubility screening. Therefore, determination of stability domain as a function of proportion Water/DMSO (i.e., elaboration of ternary phase diagram between API, Water and DMSO) allowed to describe a reliable crystallization process in DMSO/Water mix to obtain pure hydrate form and avoiding crystallization of undesired form such as anhydrous and/or DMSO solvate.

A.P.14. Crystallization-based separation studies of L-homophenylalanine from a biocatalytic reaction system - Fundamental studies

A. Schultheis^{1*}, and H. Lorenz¹

¹Max Planck Institute for Dynamics of Complex Technical Systems, Magdeburg, Germany;

*schultheis@mpi-magdeburg.mpg.de

Keywords: L-Homophenylalanine, Solubility, Solid-Liquid Equilibria, HPLC, Amino Acid

The non-natural amino acid L-Homophenylalanine (L-HPA) is employed as precursor for chiral pharmaceutical products such as β -lactam antibiotics or various inhibitors. Several biocatalytic production methods for L-HPA were developed [1, 2]. After synthesis, L-HPA has to be separated from the multi-component mixture in high purity to minimize the risk of complications in a potential drug application. This task can be accomplished using crystallization, where information regarding the solubility of the target compound as a function of process parameters such as temperature, pH and further mixture components is needed. However, there is only very limited information available regarding the fundamental crystallization properties of L-HPA in the open literature.

Our aim in a broader collaboration project is to develop a crystallization process to isolate L-HPA efficiently and in high purity from a biocatalytic reaction system. Therefore, first basic studies on the solid-state behavior and the solubility of the target compound in water have been performed showing extraordinary low solubilities compared to other amino acids (0.07 wt.% at 25 °C), which can be greatly influenced by pH [3], as shown in Figure 1. Currently, we are developing the analytics to quantify the relevant components in the biocatalytic reaction system such as educts and byproducts in the buffer system used. Further we perform isothermal solubility experiments to evaluate the influence of the admixture components on the target compounds' solubility and the basic crystallization behavior. In the contribution the results obtained will be described.

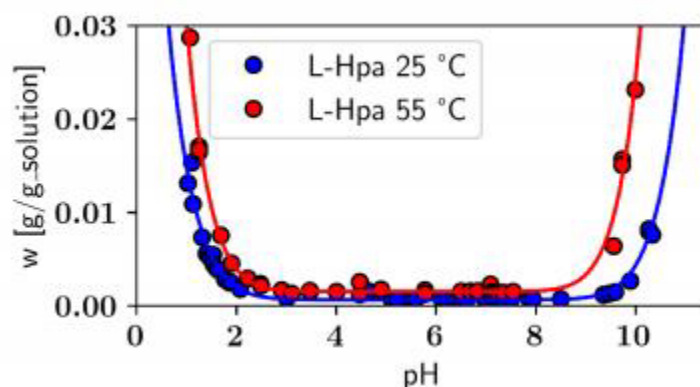

Figure 1: pH-solubility profile for L-HPA. (Adapted from [3])

[1] D. Gao, W. Song, J. Wu, L. Guo, C. Gao, J. Liu et al. *Angew. Chem. Int. Ed.* 61 (2022), e202207077

[2] A. L. Ahmad, P. C. Oh, and S. R. A. Shukor. *Biotechnol. Adv.* 27 (2009), 286–296

[3] V. Tenberg, M. Sadeghi, A. Schultheis, M. Joshi, M. Stein, and H. Lorenz. *RSC Adv.* 15 (2024), 10580–10589



A.P.15. Current view on solid-state deracemization by temperature-cycling

M.S. Hosseinalipour, L-T. Deck and M. Mazzotti*

Institute of Energy and Process Engineering, ETH Zurich, 8092 Zurich, Switzerland

*marco.mazzotti@ipe.mavt.ethz.ch

Keywords: solid-state deracemization, temperature-cycling, chiral resolution

The separation of the two enantiomers of a chiral molecule is essential in chemical, pharmaceutical and agricultural applications. [1] Temperature cycling has been demonstrated to be an attractive technique for this purpose. [2]

Using theoretical, modeling, and experimental analysis we showed that for a conglomerate compound deracemization happens if and only if crystal dissolution is faster than growth in presence of racemizing agent in solution. [3] To support this finding, we developed simple experimental protocol combined with population balance equations modeling to assess the crystallization kinetics of compounds that are reported in literature to be deracemized by temperature cycling.

In addition, to facilitate further implementation of such process in industry, this study explores strategies to improve two key performance indicators of this technique, namely productivity and solute recovery. In doing so, we show that temperature cycling at elevated temperatures accelerates deracemization and, hence, increases productivity. However, this comes at the cost of lower recovery because the solution contains a higher amount of solute due to the higher solubility at elevated temperatures. We introduce and compare two process extensions that mitigate this issue. The first involves temperature cycling followed by linear cooling, whereas the second is based on merging the temperature cycles and cooling crystallization. We show that the former variant is faster than the latter and it is easier to design and implement. [4]

The findings reported in this contribution promise to be of great interest to practitioners and researchers in industrial crystallization.

[1] Lorenz, H.; Seidel-Morgenstern, A. **Processes to Separate Enantiomers.** *Angew. Chemie - Int. Ed.* 2014, 53 (5), 1218-1250.

[2] Breveglieri, F.; Maggioni, G. M.; Mazzotti, M. **Deracemization of NMPA via Temperature Cycles.** *Cryst. Growth Des.* 2018, 18 (3), 1873-1881.

[3] Deck, L. T.; Hosseinalipour, M. S.; Mazzotti, M. **Exact and Ubiquitous Condition for Solid-State**

Deracemization in Vitro and in Nature. *Journal of the American Chemical Society.* 2024, 146 (6), 3872- 3882.

[4] Hosseinalipour, M. S.; Deck, L. T.; Mazzotti, M. **On solute recovery and productivity in chiral resolution through solid-state deracemization by temperature-cycling.** *Cryst. Growth Des.* 2024, (accepted, in press).



A.P.16. Data Uncertainty within the Small-Scale Crystallisation DataFactory

Amal Osman^{1,2}, Chantal Mustoe^{1,2}, Murray Robertson^{1,2}, Michael Chrubasik³, Paul Duncan³, Blair Johnston^{1,2}, Alastair Florence^{1,2}

1. Strathclyde Institute of Pharmacy and Biomedical Sciences, University of Strathclyde, Glasgow, UK

2. Continuous Manufacturing and Advanced Crystallisation (CMAC) Future Manufacturing Research Hub, University of Strathclyde, Glasgow, UK

3. National Physical Laboratory, Glasgow, UK

Background: Drug candidates within the discovery phase often require modification of their physiochemical properties such as particle shape and size to improve clinical efficacy while decreasing harm to patients. Crystallisation is a common technique used within pharmaceutical manufacturing for separation or purification purposes and allows for the formation of crystals of a pure active pharmaceutical ingredient (API) with varying physical properties such as melting point, dissolution rate as well as particle size and shape. However crystallization can be a resource and time-consuming process.

Aims/Objectives: The CMAC DataFactory has been developed to overcome these limitations of traditional crystallization processes¹. It uses robotic platforms and model-driven experimental design to generate initial experimental data which helps predict solubility, kinetic parameters and crystal physical attributes. By combining various sensors and data analysis techniques, the project seeks to optimize the design of the crystallization process based on these predictions. However, uncertainties throughout the DataFactory are poorly understood and thus research is being carried out to evaluate the measurement of uncertainties throughout the digital design process.

Method: Previously available literature data of thermodynamic properties will be collated and used as primary data to help create the initial experiments. Preparation of samples are carried out by *Zinsser WinLissy*, an automated robotic dispensing platform. Samples are then transferred into a *Technobis Crystalline* which will carry out various thermodynamic experiments. Experimental data will be analysed and used to develop the next best experiments. Throughout the process design, areas of measurement uncertainty will be identified and evaluated to determine their impact on the overall digital design process.

Current Plans: Various samples are being prepared to validate the efficiency and reliability of the *Zinsser*. Solubility experiments are being carried out within the *Technobis Crystalline* where different parameters such as heating rate, cooling rate, stirring rate and stirring type are being investigated to determine the impact of each of these parameters on solubility data. The aim of this research area is to confirm an optimized crystallization workflow to be incorporated within the DataFactory that will produce reliable, accurate and reproducible crystallization data over a wide range of APIs and solvents.

References

1. Pickles, T., Mustoe, C., Brown, C. & Florence, A., (2022) "Autonomous DataFactory: High-throughput screening for large-scale data collection to inform medicine manufacture", *British Journal of Pharmacy* 7(2). DOI: <https://doi.org/10.5920/bjpharm.1128>



A.P.17. Deep Learning Enhanced Correlation of Particle Descriptors to Sustainable Pharmaceutical Manufacturing Processes

Omar El-Habbak¹, Cameron Brown¹, Alexandru Moldovan², Helen Blade³, Rachael Shinebaum⁴, Alastair Florence¹

1 CMAC Future Manufacturing Hub, Strathclyde Institute of Pharmacy and Biomedical Science, University of Strathclyde, Glasgow, UK

2 Cambridge Crystallographic Data Centre, 12 Union Road, Cambridge, UK

3 Oral Product Development, Pharmaceutical Technology & Development, Operations, AstraZeneca, Macclesfield, UK

4 Technical Operations & Scientific Innovation, Pharmaceutical Technology & Development, Operations, AstraZeneca, Macclesfield, UK

Bulk properties are influenced by particle attributes, such as particle size, shape, and chemistry, defined during crystallization and/or milling processes. Understanding how particle attributes affect the pharmaceutical manufacturing process performance remains a significant challenge for the industry, adding cost and time to developing robust production routes. This places strict demands on bulk material flow properties such as blend uniformity, compactability, and lubrication, which need to be satisfied. Consequently, making the flow prediction of pharmaceutical materials during early-stage development is increasingly important. Currently, the suitability of raw materials and/or formulated blends for product development requires detailed, time-consuming experimental characterisation of the bulk properties.

Machine learning techniques using particle informatics are gaining increasing ground within pharmaceutical drug design, especially in lead generation (Griffen, 2018, *Drug Discovery Today* 23(7)) compared to drug product manufacturing. Due to high complexity and limited computational/experimental descriptors, particle product performance models have been more challenging to develop. Alongside the limited available training data, the sector does not only demand results-driven models but also those which are explainable (Moss, 2022, *Neurocrit Care* 37(2), Manzano, 2022, *BioPharm International* 35(1)).

This project aims to deliver novel, interpretable machine learning and deep learning models for predicting powder flow considering physical, chemical, and computed molecule/particle features. The output of this model will facilitate the rapid development of new medicines manufacturing.



A.P.18. Effect of impeller diameter on crystallization kinetics in borax sonocrystallization under pulsed ultrasound irradiation

A. Čelan^{1*}, M. Čosić¹, P. Bikić¹, T. Đolonga¹, N. Kuzmanić¹

¹University of Split, Faculty of Chemistry and Technology, R. Boškovića 35, 21000
Split, HR

*antonija.celan@ktf-split.hr

Keywords: sonocrystallization, mechanical mixing, borax, crystallization kinetics

The main goal of this pilot study was to assess the impact of impeller diameter on crystallization kinetics in borax sonocrystallization. Experiments were conducted in a 2.65 dm³ crystallizer in which mechanical mixing and ultrasound irradiation were applied simultaneously. Mixing was performed by employing the flat-blade turbine (4-SBT) at just-suspended impeller speed (N_{js}) to ensure optimal heat and mass transfer conditions. It was found in previous studies that crystals tend to be smaller and more regularly shaped when sonication is continuously applied ($A = 20\%$, $P = 100\%$) in comparison to silent systems. However, the power input from continuous ultrasound irradiation exceeded that from mechanical mixing by approximately tenfold. This is why in this study, pulsed sonication was applied ($A = 20\%$, $P = 20\%$). Results show that by increasing the impeller diameter (under pulsed sonication and at just-suspended impeller speed) the onset of nucleation is delayed. Regarding the final product, in all cases – a monomodal crystal size distribution was obtained. Also, by increasing the impeller diameter, the share of fines increases while the mean volume diameter decreases.

A.P.19. Effects of Ultrasound on Reactive Crystallization and Particle Properties of an Aromatic Amine in Batch and Continuous modes

Biyu Zhang^{1,*}, Georgios Stefanidis², and Tom Van Gerven¹

¹ Department of Chemical Engineering, Process Engineering for Sustainable Systems, KU Leuven, Celestijnenlaan 200F, 3001 Heverlee, Belgium;

² School of Chemical Engineering, Department of Process Analysis and Plant Design, National Technical University of Athens, Iroon Polytechniou 9, Zografou 15780,

Athens, Greece

[*biyu.zhang@kuleuven.be](mailto:biyu.zhang@kuleuven.be)¹

Keywords: Ultrasound, reactive crystallization, particle property, batch crystallization, continuous crystallization

Focusing on the reactive crystallization system of an aromatic amine, this study experimentally explored the potential applications of ultrasound in both batch and continuous modes. In batch experiments, the effects of different sonication conditions including power, duration, and starting point on final particle properties were investigated. Under ultrasound, the crystal form and crystal morphology remained well maintained. The results of particle size and size distribution (Figure 1) suggested ultrasound reduced the mean sizes probably by enhancing the nucleation process and the deagglomeration of large particles. In continuous experiments, the presence of ultrasound was also capable of inducing nucleation and the collected crystal products had a good distribution (Figure 1). Integrating ultrasound into the beginning of the continuous crystallization process can be considered as an alternative to the seeding technique. The increasing sonication power did not reduce the induction time substantially, which indicated a rational sonication condition should be a tradeoff between overall process efficiency and energy efficiency. Inspired by the findings in batch and continuous experiments, it is expected that incorporating energy-efficient ultrasound with the continuous process could be a useful intensification technique in industrial crystallization of the aromatic amine, leading to increased production efficiency and a well-controlled product quality.

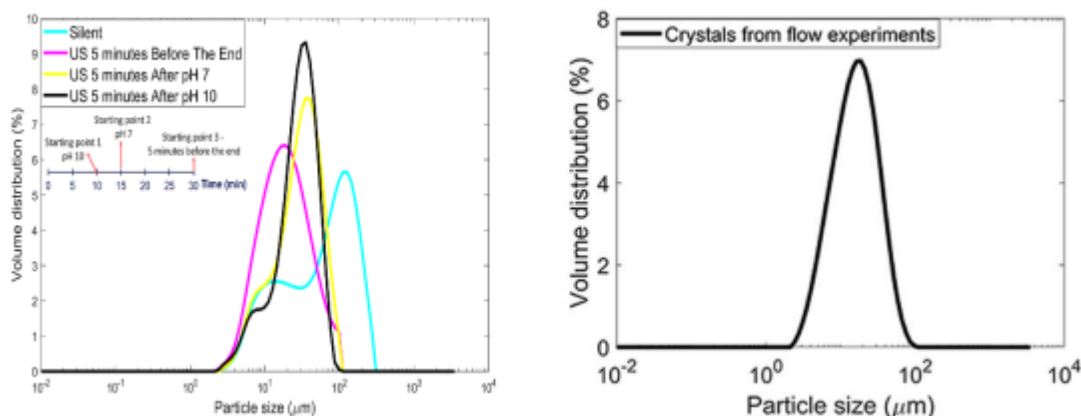

Figure 1. Examples of particle size distribution in batch (left) and continuous (right) experiments under ultrasound.



A.P.20. Evaporative crystallization of sessile droplets using electrowetting

Q. An¹, Pingping Cui^{1,2}, Bijoy Bera¹, Massimo Mastrangeli¹, Johan T. Padding¹, and Burak Eral^{1,*}

¹ Delft University of Technology, the Netherlands;

² Tianjing University, China

H.B.Eral@tudelft.nl

Keywords: Crystallization, glycine, droplet, evaporation, electrowetting

This paper reports a novel approach for controlling the evaporative crystallization of sessile droplets of aqueous glycine solution by utilizing electrowetting. Glycine, the simplest amino acid, has three polymorphs, namely, α , β , and γ . Under ambient conditions, α - and γ -glycine remain stable, whereas metastable β -glycine crystals gradually transform into α and/or γ forms. Notably, β - and γ - glycine exhibit unique piezoelectric response due to their non-centrosymmetric space groups [1]. Previous studies have employed various methods to obtain the metastable β - or γ -glycine polymorphs, including quasi-double emulsions, templating techniques [2], and the application of electric fields [3], etc. Electrowetting (EW) [4] is a versatile tool to switch the wettability of substrates and manipulate droplets. Few reports have studied the evaporation of water droplets or colloidal solution with electrowetting [5]. Here, we present the first report on the evaporation of glycine solution using electrowetting, demonstrating the ability to control the polymorphs of glycine crystals through electrowetting. On a hydrophilic surface, a mixture of bipyramidal α and needle-like β crystals was observed in the coffee stain. On a hydrophobic surface, the droplets evaporated without contact line pinning, and small bipyramidal α crystals formed. Further, we tune the surface wettability dynamically through electrowetting as the sessile droplet evaporated. Consequently, glycine crystallized with distinct polymorphic forms (β and γ) and morphologies compared to crystals nucleating on hydrophilic and hydrophobic surfaces. Our results highlight electrowetting as a promising tool for controlling the evaporative crystallization of sessile droplets.

- [1] Guerin, Sarah, et al. (2018): **Control of piezoelectricity in amino acids by supramolecular packing**, *Nature Materials*, 17, 180.
- [2] Seyedhosseini, Ensieh, et al. (2014): **Growth and nonlinear optical properties of β -glycine crystals grown on Pt substrates**, *Crystal Growth & Design*, 14, 2831.
- [3] Aber, Janice E., et al. (2005): **Strong dc electric field applied to supersaturated aqueous glycine solution induces nucleation of the γ polymorph**, *Physical review letters*, 94, 145503.
- [4] Mugele, Frieder, and Jean-Christophe Baret. (2005): **Electrowetting: from basics to applications**, *Journal of physics: condensed matter*, 17, R705.
- [5] Eral, H. Burak, et al. (2011): **Suppressing the coffee stain effect: how to control colloidal self-assembly in evaporating drops using electrowetting**, *Soft Matter*, 7, 4954.



A.P.21. Feasibility of Data-Driven Model to Predict Crystallisation Induction Time

M.K. Mandaza^{1,2*}, C. Brown^{1,2}, and J. Sefcik^{1,3}

¹Strathclyde Institute of Pharmacy & Biomedical Sciences, University of Strathclyde, Glasgow, UK

²EPSRC Future Manufacturing Hub for Continuous Manufacturing and Advanced Crystallisation, Technology and Innovation Centre, University of Strathclyde, UK

³Department of Chemical and Process Engineering, University of Strathclyde, Glasgow, UK
*mitchelle.mnemo@strath.ac.uk

Keywords: Active pharmaceutical ingredient (API), nucleation kinetics, scale-up, machine learning.

Active pharmaceutical ingredient (API) crystallisation is integral in the drug manufacturing process¹, influencing product quality, yield, and production efficiency. The more complex drug structures and advanced formulations become, the more challenging they are to crystallise². It is critical to understand the chemical and mechanical properties of solutes and solvents and their influence on induction time, a vital parameter of crystallisation kinetics. During the transition from laboratory-scale production to manufacturing, various technology transfer stages are necessary. It's crucial to recognise that different crystallisation systems may not respond uniformly to scale-up, and the effects on each active pharmaceutical ingredient (API) being developed can vary³.

Induction time is a key kinetic characteristic of crystallisation reactions⁴. A lack of understanding of how process parameters such as cooling rate and agitation influence crystallisation, makes controlling these processes more challenging and consequently affects the final drug product quality. The ability to accurately predict the induction time of a solute/solvent system will provide an initial step to the design and optimisation of crystallisers.

Machine learning methods have been used widely for the prediction of physicochemical properties and the prediction of suitable solvents for crystallisation^{5,6}. By implementing machine learning tools, this study explores the relationship between solute-solvent properties and induction times for APIs. A predictive model is developed utilising molecular features to forecast induction times for unknown solute-solvent combinations. These methods enable the understanding of the complex processes involved. As well as reducing resource waste and loss, they save experimental time. Comprehensive data analysis will reveal insights into the relationships between induction time and various variables, enabling appropriate predictions and informed decisions related to industrial crystallisation development.

[1] Chanda A, Daly AM, Foley DA, Lapack MA, Mukherjee S, Orr JD, et al. Industry perspectives on process analytical technology: Tools and applications in API development. *Org Process Res Dev.* 2015;19(1):63–83.

[2] Chen J, Sarma B, Evans JMB, Myerson AS. Pharmaceutical Crystallization Published as part of the Crystal Growth & Design 10th Anniversary Perspective. 2011;887–95.

[3] Nere NK, Diwan M, Czyzewski AM, Marek JC, Sinha K, Li H. Case Studies on Crystallization Scale-Up. *Chem Eng Pharm Ind.* 2019;617–33.

[4] Maosoongnern S, Flood AE. Validation of Models Predicting Nucleation Rates from Induction Times and Metastable Zone Widths. *Chem Eng Technol.* 2018;41(10):2066–76.

[5] Boobier S, Hose DRJ. Machine learning with physicochemical relationships: solubility prediction in organic solvents and water. *Nat Commun [Internet].* (2020):1–10. Available from: <http://dx.doi.org/10.1038/s41467-020-19594-z>

[6] Diaz LP, Brown J, Ojo E. Machine Learning Approaches to the Prediction of Powder Flow Behaviour of Pharmaceutical Materials from Physical Properties. :1–11.



A.P.22. Importance of Seed Design to Crystallization-Induced Deracemizations

Sjoerd W. van Dongen^{1*} and Willem L. Noorduin^{1,2**}

¹AMOLF, Amsterdam, the Netherlands;

²Van 't Hoff Institute for Molecular Sciences, University of Amsterdam,
Amsterdam, the Netherlands

*vdongen@amolf.nl, **noorduin@amolf.nl

Keywords: chirality, crystallization of organic molecules, deracemization, seed crystals

Obtaining enantiomerically pure compounds is a critical challenge for pharmaceutical industry, given over 90% of newly marketed drugs are chiral [1]. Traditional synthetic methods, however, often yield racemic mixtures, while asymmetric syntheses require expensive chiral catalysts or reagents or are limited in scope. Pasteur's demonstration of preferential crystallization has opened up a simple and scalable route for the resolution of chiral compounds that crystallize as conglomerates (i.e. enantiomerically pure crystals of left- and right-handed molecules). A subsequent breakthrough by Viedma demonstrated full deracemization of NaClO₃ through grinding [2]. Viedma Ripening, along with similar processes based on temperature cycles (TCID) or solvent cycling, has been extended to organic molecules and exhibits yields of up to 100% (as compared to 50% for separation), thereby showing great promise for the development of industrial scale crystallization-induced deracemization processes [3-5]. Seeding is a critical part of crystallization processes that can greatly determine their outcome and the significance of the purity and composition of the seed crystals that kickstart the deracemization processes has been established [6, 7]. So far, however, the deliberate design of these seed crystals remains underexplored. Here, we systematically study how design parameters such as size, shape, surface properties and crystal structure affect the crystallization-induced deracemization process. We show that rational seed design can greatly enhance the deracemization kinetics, while an unfortunate choice of seed crystals could potentially lead to racemization rather than deracemization. As such effects will be more pronounced with larger scale, these findings are crucial for industrial-scale implementation of crystallization-induced deracemizations.

- [1] L.A. Nguyen, H. He and C. Pham-Huy (2006): **Chiral Drugs: An Overview**, *Int. J. Biomed. Sci.*, 2, 85–100.
- [2] C. Viedma (2005): **Chiral Symmetry Breaking During Crystallization**, *Phys. Rev. Lett.*, 94, 065504.
- [3] W.L. Noorduin, T. Izumi, A. Millemaggi, M. Leeman, H. Meekes, W.J.P. van Enkevort, R.M. Kellogg, B. Kaptein, E. Vlieg and D.G. Blackmond (2008): **Emergence of a Single Solid Chiral State from a Nearly Racemic Amino Acid Derivative**, *JACS*, 130, 1158–1159.
- [4] K. Suwannasang, A.E. Flood, C. Rougeot and G. Coquerel (2013): **Using Programmed Heating–Cooling Cycles with Racemization in Solution for Complete Symmetry Breaking of a Conglomerate Forming System**, *Cryst. Growth Des.*, 13, 3498–3504.
- [5] S. W. van Dongen, I. Baglai, M. Leeman, R. M. Kellogg, B. Kaptein and W. L. Noorduin (2023): **Rapid deracemization through solvent cycling**, *Chem. Commun.*, 59, 3838–3841.
- [6] F. Zhang, B. Shan, Y. Wang, Z. Zhu, Z. Yu and C. Y. Ma (2021): **Progress and Opportunities of Seeding Technique in Crystallization Processes**, *ORPD*, 25, 1496–1511.
- [7] S. W. van Dongen, I. Ahlal, M. Leeman, B. Kaptein, R. M. Kellogg, I. Baglai and W. L. Noorduin (2023): **Chiral Amplification through the Interplay of Racemizing Conditions and Asymmetric Crystal Growth**, *JACS*, 145, 436–442.

A.P.23. Influence of processing conditions on the industrial crystallisation and crystal morphology of iron (II) sulphate heptahydrate

G. Sumanskaite^{1*}, D. Harbottle¹, A. Brown², J. Edwards², R. Evans¹ and K. Roberts¹

¹University of Leeds, Leeds, UK

²Venator Ltd, Stockton-on-Tees, UK

*cm17g2s@leeds.ac.uk

Keywords: Crystal growth; Crystal structure; Iron sulphate heptahydrate

Iron (II) sulphate heptahydrate, IS7, is a green-blue coloured crystalline material with various industrial applications, such as a flocculant in water treatment processes. IS7 is typically formed as a co-product in titanium dioxide pigment manufacture using the sulphate process [1]. It is known that the crystallisation process and resultant crystal morphology can be affected by processing conditions such as supersaturation, impurity content, and solution pH. The latter can also influence the solubility and stability of IS7, which can readily dehydrate to other hydrate forms and/or oxidise to Fe^{3+} under ambient conditions. Each of the hydrated forms has a distinct crystalline structure and colour; hence, it is important to understand how processing conditions affect the crystal growth and stability of IS7 [2].

Examination of the packing in the unit cell of IS7 revealed a layered iron, sulphate and seventh water of crystallisation structure. It was observed that IS7 exhibited two iron environments, where angles and distances between Fe-O varied. The crystal morphology was then predicted using the consistent valence forcefield, which was used to investigate the d-spacing, surface area and rugosity of each facet. It was revealed that (1 0 0)

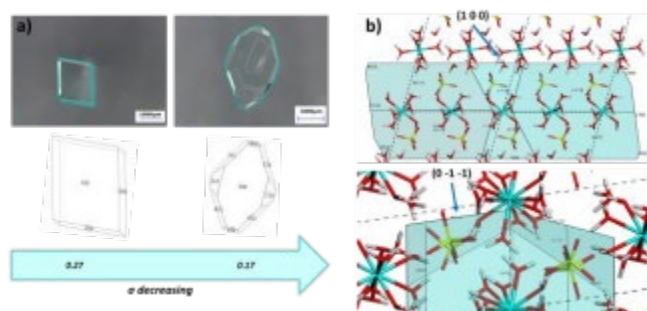

Figure 1. a) IS7 crystal growth as a function of supersaturation. b) Surface chemistry of (1 0 0)

and (0 -1 -1) facets and (0 -1 -1) facets, yielding the lowest growth rate. This suggests that IS7 crystals exhibit plate-like morphological growth, which is affected by the supersaturation (Fig. 1a). Single crystal growth studies revealed that higher supersaturation yielded cuboid morphology, where the surface chemistry of (0 -1 -1) facet exhibited mixed functional groups (Fig. 1b). Lower supersaturation yielded prismatic crystals, where surface chemistry of (1 0 0) facet consisted of only water molecules (Fig. 1b). Overall, this study demonstrates how the solubility and crystal morphology of IS7 are affected by process conditions to enable its optimisation for obtaining the prismatic form to improve downstream processing.

[1] W. Zhang, Z. Zhu, and C.Y. Cheng (2011): A literature review of titanium metallurgical processes, *Hydrometallurgy* 108, 177-188.

[2] J. Zhou, Y. Zeng, G.P. Demopoulos, C. Li, and Z. Li (2018): Phase Transition of $\text{FeSO}_4 \cdot 7\text{H}_2\text{O}$ to $\text{FeSO}_4 \cdot \text{H}_2\text{O}$ in the H_2SO_4 - HCl - H_2O System by Modeling Solubility, *ACS Sustain. Chem. Eng* 6, 2207-2219.



A.P.24. In-Situ Studies Of Crystallization And Filtration Processes Using Time-Resolved Synchrotron Based X-Ray Phase Contrast Imaging (Xpci)

O. V. Towns^{1,2}, A. Alshukri¹, N. Hennessy¹, T. Mahmud¹, J. Leng³, S. Ottoboni^{2,4}, C. J. Price^{2,4}, H. Wheatcroft⁵, A. Jawor-Baczynska⁵, S. L. M. Schroeder^{1,2}

¹Chemical and Process Engineering, University of Leeds, Leeds, LS2 9JT, UK, ²EPSRC Centre for Innovative Manufacturing in Continuous Manufacturing and Crystallisation, University of Strathclyde, Glasgow, G1 1RD, UK, ³School of Computer Science, University of Leeds, Leeds, LS2 9JT, UK, ⁴Department of Chemical and Process Engineering, University of Strathclyde, Glasgow, G1 1RD, UK, ⁵Chemical Development, Pharmaceutical Technology & Development, Operations, AstraZeneca, Macclesfield, UK

Introduction: Synchrotron X-ray phase contrast imaging (XPCI) allows rapid microscopic imaging of multiphase systems that have otherwise low X-ray absorption contrast, such as organic crystals in solvents. This permits time-resolved studies of the structural evolution of dynamic systems. This technique has now been applied to both crystal population analysis, using 2D radiographic imaging, and to filtration processes, using 3D tomography scans.

Crystal Growth Radiography: Synchrotron based XPCI was used to image glycine cooling crystallizations in real-time with high frame rates (100 Hz) and similar resolution to conventional microscopic imaging probes ($\sim 1 \mu\text{m}$). This method has some advantages over standard microscopic monitoring: Due to the parallel X-ray beam, all crystals in the imaged volume are resolved, minimizing the influence of out-of-focus crystals obscuring the foreground or background, making automatic processing easier compared to optical imaging techniques. There is scope to pair this technique with other X-ray modalities, e.g. dual imaging and diffraction (DIAD). Finally, 3D information can be obtained from a single 2D XPCI image [1], so crystal populations can be tracked through time in 3 dimensions, which can be used to inform more accurate 3D population balance models (PBMs). A software package that automatically detects crystals in an XPCI video and extracts information on the crystal population size with respect to time in 2-dimensions has already been created, with the intention to extend this study into 3 dimensions using Paganin filtering [1].

Filtration Tomography: Synchrotron based XPCI was also used to image filtration processes using 3-dimensional tomography. Exposure time for low absorbing mediums (such as organic API inorganic solvent) using standard laboratory tomography equipment is too long for dynamic, *in-situ*, studies to take place. The short exposure times gained by using synchrotron phase contrast imaging allowed for scans to take place in under a minute, rather than multiple hours, enabling *in-situ* 3D imaging of filtration, washing, and drying processes. Parameters were varied such as API size and shape, washing solvent, filtration endpoint, and drying rate. Scans were taken throughout each process and are analogous to frames in a video, but in 3-dimensions. Each phase in ascan can be separated and analysed. With the data collected more insights can be made into each process step, and important information such as impurity retention can be investigated.

References:

[1] Paganin D. et al. (2002) *Journal of Microscopy*, 206, 1, 33 - 40.



A.P.25. Laser induced nucleation emerging from interaction of thermocavitation bubble pairs

N. Nagalingam¹, A.Vignesh¹, V. Korede¹, H.J.M. Kramer¹, A.

E.D.M. van der Heijde¹, R.Hartkamp¹, J. T. Padding¹, and Hüseyin Burak Eral^{1*}

¹ Process & Energy Department, Delft University of Technology,5

Leeghwaterstraat 39, 2628 CB Delft, Netherlands

[*h.b.eral@tudelft.nl](mailto:h.b.eral@tudelft.nl)

Keywords: Laser induced nucleation, Thermocavitation, Hydrodynamics, Laser induced crystallization

Crystallization from solution is central to technological applications ranging from nanomaterial synthesis to pharmaceutical manufacturing [1]. Among the strategies proposed to control kinetics and emerging crystal properties, nonphotochemical laser-induced nucleation (NPLIN), where one or more unfocused laser pulses trigger accelerated nucleation in supersaturated solutions, emerged as a promising approach due to its presumed nonchemical nature and ability to influence polymorphic form [2,3].

We demonstrate a novel crystallization route from supersaturated aqueous solutions of a model inorganic salt, potassium permanganate (KMnO₄) arising from interaction between laser-induced micro-bubble pairs. “Jets” of fast-moving liquid emerge due to bubble-bubble interaction along the axis connecting the bubble centres. These jets enable crystallization at much lower laser energies and solution supersaturations compared to crystallization involving a single bubble. We report an increase in the crystal nucleation kinetics with jet velocity and attribute it to the shear induced by the impingement of the jet over the liquid surrounding the bubble. The proposed theory for crystallization employs Classical Nucleation Theory with the effect of shear embodied into the kinetic prefactor. Furthermore, we numerically simulate the evolution of the jet using the axisymmetric Boundary Integral Element Method, and determine the characteristic scaling laws for jet velocity on bubble-bubble standoff distance, capillary diameter and laser energy. The findings contribute to the interdisciplinary field of primary nucleation control of crystallization from solution.

[1] D. Kashchiev, Nucleation: Basic Theory with Application, Butterworth-Heinemann, London, 2000

[2] N. Nagalingam et al. Laser-Induced Cavitation for Controlling Crystallization from Solution, **Phys. Rev. Lett.** 2023,131, 124001

[3] V.Korede et al A Review of Laser-Induced Crystallization from Solution, **Cryst. Growth Des.** 2023, 23, 5, 3873–3916



A.P.26. Magnetism and Turbulence: a macroscopic pathway to novel crystallization

P. A. L othman^{1,2*}, F. M. Penha³, S. D. Ferreira Rocha⁴, and L. Abelman⁵

¹European University of Applied Science Hamburg, Hamburg, Germany

²University of Bayreuth, Chair of Additive Processes for Tissue Reconstruction (“Organ Printing”), Bayreuth, Germany

³KTH Royal Institute of Technology, Department of Chemical Engineering, Division of Resource Recovery, Stockholm, Sweden

⁴Universidade Federal de Minas Gerais-UFMG, Department of Mining Engineering, Belo Horizonte, Brazil

⁵TU Delft, Department of Microelectronics, Delft, The Netherlands

*per.arvid.loethman@euro-fh.de;

*per.loethman@uni-bayreuth.de

Keywords: Self-assembly, crystallization, magnetism, turbulence

Crystals do not only grow by via attachment of atoms, ions or molecules but also through attachment of particles as in non-classical crystallization pathways [1,2]. Oriented attachment-based self-assembly and crystallization has been shown for inorganic colloids, nanoparticles and mesocrystals, which are mesoscopically structured crystals composed of single nanocrystals which exhibit nanocrystal and single crystalline properties simultaneously [3,4,5,6]. Not only interparticle interactions, particle size distribution but especially the particle **shape** have proven to be of a major importance in nanoparticle self-assembly and crystallization and determine their classical or non-classical crystallization and self-assembly behaviour and the resulting material; Spherical nanoparticles self-assemble spontaneously only if their size distribution is narrow and exhibit a polydispersity of <5% which leads to dense 2D and 3D materials [3,4]. Non-spherical nanoparticles deviate from classical self-assembly and show different types of nonclassical behaviour i.e. oriented attachment-based self-assembly and crystallization [7,8,9]. Various liquid crystal structures (smectic, nematic phases) resulted from non-classical self-assembly of rodlike or platelike nanoparticles at high concentration and bundle-structures was observed for nanowires [10, 11] whereas self-assembly of gold-silver nanoparticles (spheroids, rods, plates) with various aspect ratios from 1-25 all having short axis of 10-30nm resulted in various shape-dependent structures (honeycomb, oriented attachment, smectic 2D, ribbon, bundles, nematic order) [12]. The self-assembly of nanoparticles and non-classical crystallization is the most essential step for successful applications in nanodevices such as sensors, actuators and microrobots, but also in the development of new nano-, micro- and mesoscopic materials with novel interesting properties. The latest advances in nanoparticle synthesis has led to a high degree of anisotropy in the nanoparticles and therewith resulting in a plethora of various sizes, shapes and dimensions which may provide an opportunity to predict how to use the nanoparticle in the nano-devices and novel materials. However, the underlying dynamics of self-assembly and crystallization is largely unknown as the time scale for self-assembly processes lies in the nano-or femtosecond range at the nanoscale. In other words, a controllable venue to how to manufacture and synthesize novel nanomaterials and devices may be literally “invisible” or near impossible to investigate within a reasonable framework. Here we present an alternative route to study self-assembly and crystallization which is based upon “macroscopic magnetic self-assembly” and its most central component the self-assembly reactor. We have shown that centimeter sized macroscopic particles conduct a Brownian motion and that turbulence represent a thermal energy also on the macroscopic scale. This is a prerequisite for studying self-assembly of macroscopic particles of various shapes and transfer and learn from the results also for nanoparticle self-assembly and crystallization. We have shown that different **shapes** (magnetic centimeter-sized cuboids, cylinders, spheres and elliptical shapes) lead to different materials i.e. 1D, 2D or 3D materials depending on the interaction due to the particle shape similar to nanoparticle self-assembly as described earlier. We elucidate how the results from macroscopic self-assembly may serve as a design model for



electrostatically interacting nano- and microparticles for 3D self-assembly and crystallization finding applications in 3D electronics, biomaterials, metamaterials, or data storage [13-17].

- [1] H. Cölfen (2020), **Nonclassical Nucleation and Crystallization**, Crystals, 10, 61; doi:10.3390/cryst10020061
- [2] S. Karthika, T.K. Radhakrishnan, P. Kalaichelvi (2016), **Review of Classical and Nonclassical Nucleation Theories**, Cryst. Growth Des., 16, 6663–6681
- [3] C.P. Collier, T. Vossmeier, J. R. Heath (1998), **Nanocrystal Superlattices**, Annual Review of Physical Chemistry 49(1):371-404, DOI: 10.1146/annurev.physchem.49.1.371
- [4] M.P. Pileni (2001), **Nanocrystal Self-Assemblies: Fabrication and Collective Properties**, Phys. Chem. B, 105, 17, 3358–3371, <https://doi.org/10.1021/jp0039520>
- [5] E.V. Sturm, H. Cölfen (2017), **Mesocrystals: Past, Presence, Future**, Crystals, 7, 207; doi:10.3390/cryst7070207
- [6] V. K. Ivanov, P. P. Fedorov, A. Ye. Baranchikov and V. V. Osiko (2014) **Oriented attachment of particles: 100 years of investigations of non-classical crystal growth**, Russ. Chem. Rev. 83 1204
- [7] B. A. Korgel and D. Fitzmaurice (1998), **Self-Assembly of Silver Nanocrystals into Two-Dimensional Nanowire Arrays**, Adv. Mater. 10, No. 9, 661-665
- [8] R.L. Penn, J.F. Banfield (1998), **Imperfect Oriented Attachment: Dislocation Generation in Defect-Free Nanocrystals**, Science, 281, 969-971
- [9] C. Pacholski, A. Kornowski, H. Weller (2002) **Self-assembly of ZnO: from nanodots to nanorods**, Angew Chem Int Ed Engl, Apr 2;41(7):1188-91.
- [10] H. Maeda, Y- Maeda (2003), **Liquid Crystal Formation in Suspensions of Hard Rodlike Colloidal Particles: Direct Observation of Particle Arrangement and Self-Ordering Behavior**, Phys. Rev. Lett. 90, 018303
- [11] B. Vigolo, A. Pénicaud, C. Coulon, C. Sauder, R. Pailler, C. Journet, P. Bernier, P. Poulin (2000), **Macroscopic Fibers and Ribbons of Oriented Carbon Nanotubes**, Science, Vol 290, Issue 5495, pp. 1331-1334
- [12] N. R. Jana (2004), **Shape effect in nanoparticle self-assembly**, Angew Chem Int Ed Engl., Mar. 12;43(12):1536-40. doi: 10.1002/anie.200352260.
- [13] P. A. L othman, T. A. G. Hageman, M. C. Elwenspoek, G.J.M. Krijnen, M. Mastrangeli, A. Manz, and L. Abelmann (2019), **A Thermodynamic Description of Turbulence as a Source of Stochastic Kinetic Energy for 3D Self-Assembly**, Adv. Mater. Interfaces, 1900963
- [14] T. A. G. Hageman, P. A. L othman, M. Dirnberger, M. C. Elwenspoek, A. Manz, and L. Abelmann (2018), **Macroscopic equivalence for microscopic motion in a turbulence driven three-dimensional self-assembly reactor**, Journal of Applied Physics 123, 024901
- [15] L. Abelmann, T. A. G. Hageman, P. A. L othman, M. Mastrangeli, M.C. Elwenspoek (2020), **Three-dimensional self-assembly using dipolar interaction**, Sci. Adv.; 6 : eaba2007 8 May
- [16] P. A. L othman (2021), **Putting order into Matter - Self-assembly Strategies for Novel Materials**, 2nd Edition of Webinar on Chemistry, Endeavor Research Group, 7th-8th June
- [17] P. A. L othman, T.A.G. Hageman, A. Manz, L. Abelmann (2016), **Novel Biomaterials via Viral Infection and Magnetic Self-assembly in a macroscopic Brownian Field**, Bio-inspired Materials 2016, 22nd-25th February, Potsdam, Germany.



A.P.27. Mechanism of leaching and antisolvent crystallization of spent lithium-ion batteries in ascorbic acid system

Yang Zhou^{1,2}, Michael Svärd^{1,*} and Kerstin Forsberg^{1,*}

¹KTH Royal Institute of Technology, Department of Chemical Engineering, 114 28
Stockholm, Sweden;

²China University of Mining and Technology, School of Chemical Engineering and
Technology, 221116, Jiangsu, China;

*micsva@kth.se; kerstino@ket.kth.se

Keywords: Ascorbic acid, antisolvent crystallization, Spent lithium-ion battery, Recycling

Abstract:

With the increasingly serious energy crisis and environmental pollution problems, the recycling and resource utilization of spent lithium-ion batteries have attracted widespread attention. In this paper, the leaching and antisolvent crystallization experiments of the cathode materials of spent lithium-ion batteries were carried out by choosing ascorbic acid, which is a low-priced, easily available and clean organic acid. The results show that ascorbic acid has good leaching efficiency in leaching NMC₁₁₁ without the addition of reducing agent due to its own reducing property. The optimum leaching time was 80 min at 70 °C, and the leaching rates of Li, Ni, Mn and Co were 80 %, 86 %, 83 % and 80 %, respectively. The extension of leaching time will not affect the leaching rate, but will deepen the color of the leach solution and increase the pH value. Meanwhile, the antisolvent crystallization experiments were carried out at 25 °C with ethanol as the antisolvent, and the settling efficiency was balanced at 154 h of crystallization. At this time, the precipitation efficiencies of Li, Ni, Mn and Co were 16 %, 85 %, 67 % and 83 %, respectively. Thereafter, the extension of the crystallization time had no significant effect on the improvement of the crystallization efficiency. The reason for the low precipitation efficiency of Li metal was attributed to the saturation of Li in NMC₁₁₁ during crystallization, and the addition of MnCO₃ to the crystallization solution to generate Li₂CO₃ could improve the precipitation efficiency of Li. In conclusion, this study shows that the use of ascorbic acid as leaching agent for metal leaching from spent lithium-ion batteries and metal recovery by ethanol antisolvent crystallization is a new and efficient recovery route. It provides theoretical guidance for efficient and clean recycling of spent lithium-ion batteries.

Reference:

- [1] Li L, Lu J, Ren Y, et al. (2012): **Ascorbic-acid-assisted recovery of cobalt and lithium from spent Li-ion batteries**, *Journal of Power Sources* 218, 21-7.
- [2] Ma C, Svärd M, Forsberg K (2022). **Recycling cathode material LiCo₁/3Ni₁/3Mn₁/3O₂ by leaching with a deep eutectic solvent and metal recovery with antisolvent crystallization**, *Resources, Conservation and Recycling* 186:106579.
- [3] Refly S, Floweri O, Mayangsari TR, et al. (2020): **Regeneration of LiNi₁/3Co₁/3Mn₁/3O₂ Cathode Active Materials from End-of-Life Lithium-Ion Batteries through Ascorbic Acid Leaching and Oxalic Acid Coprecipitation Processes**, *ACS Sustainable Chemistry & Engineering*, 8 (43), 16104-14.



A.P.28. Melting properties of L-homophenylalanine revealed from Fast Scanning Calorimetry

Fanfan Du¹, Axel Schultheis¹, Albrecht Petzold², Thomas Thurn-Albrecht², and Heike Lorenz^{1*}

¹Max-Planck-Institute for Dynamics of Complex Technical Systems, Magdeburg, Germany; ²Institute of Physics, Martin Luther University Halle-Wittenberg, Halle, Germany

*lorenz@mpi-magdeburg.mpg.de

Keywords: Melting properties; L-Homophenylalanine; Fast Scanning Calorimetry

Melting properties of biomolecules are crucial for biopharmaceutical engineering. The direct determination of these properties by using conventional calorimeters is often impossible for biological compounds due to decomposition during slow heating. L-Homophenylalanine (L-Hpa), a chiral unnatural amino acid, is used as a pharmaceutical intermediate and a precursor for producing various pharmaceutical drugs, such as for treatment of hypertension or cardiovascular diseases. Classical Differential Scanning Calorimetry (DSC) failed to provide melting properties for this compound [1] as it is the case for other amino acids as well. In the current study, this limitation is overcome by using Fast Scanning Calorimetry (FSC) [2, 3] to directly measure the melting properties of L-Hpa.

By applying FSC with different heating rates, we succeeded to avoid decomposition and thus determined the melting temperature of L-Hpa (extrapolated to zero heating rate), as $T_{\text{fus}} = (546 \pm 8)$ K, and enthalpy of fusion $\Delta_{\text{cr}}^{\text{L}}H(T_{\text{fus}}) = (18 \pm 2) \text{ kJ mol}^{-1}$. A reversible endothermic event occurs around 393 K, regardless of the heating rate within the measurement range of 0.033 to 8000 K/s, while it is absent in racemic D,L-Homophenylalanine (D,L-Hpa). These thermodynamic reference data may later assist in developing effective computational protocols, such as prediction of solubility of L-Hpa in different solvents, and further distinguishing polymorphs.

[1] V. Tenberg, M. Sadeghi, A. Schultheis, M. Joshi, M. Stein, H. Lorenz (2024): **Aqueous solution and solid-state behaviour of L-homophenylalanine: experiment, modelling, and DFT calculations**, *RSC Advances* 14, 10580-10589.

[2] Y. Z. Chua, H. T. Do, C. Schick, D. Zaitsau, C. Held (2018): **New experimental melting properties as access for predicting amino-acid solubility**, *RSC advances* 8(12), 6365-6372.

[3] H. T. Do, Y. Z. Chua, A. Kumar, D. Pabsch, M. Hallermann, D. Zaitsau, C. Held (2020): **Melting properties of amino acids and their solubility in water**, *RSC advances* 10(72), 44205-44215.



A.P.29. Metastable Zone Width and Growth Kinetics of Soda Ash Hydrates in the $\text{Na}_2\text{CO}_3\text{-NaOH-H}_2\text{O}$ System

S. Ghaffari^{1,*}, M.F Gutierrez¹, P. Schulze¹, and H. Lorenz¹

¹Max Planck Institute for Dynamics of Complex Technical Systems, Magdeburg, Germany;
*ghaffari@mpi-magdeburg.mpg.de

Keywords: Soda ash, MSZW, crystallization kinetics, short-cut-method.

CODA (Carbon-negative sODA ash) represents an environmental friendly process strategy to produce soda ash (sodium carbonate), in which the emission of CO_2 and NH_3 to the air, and the generation of the hazardous wastewaters are avoided. As a part of this process strategy, after the absorption process of CO_2 with sodium hydroxide based on direct air capture (DAC) [1, 2], the crystallization of soda ash hydrates in the $\text{Na}_2\text{CO}_3\text{-NaOH-H}_2\text{O}$ system was studied and is addressed in this contribution.

The metastable zone widths (MSZW) of both the deca- and monohydrates were measured in a scale of a 3 L draft tube baffled crystallizer. Based on the solid-liquid equilibrium (SLE) data acquired earlier and the MSZW, cooling and vacuum evaporation crystallization experiments were designed to measure the growth kinetics of these hydrates. The short-cut-method [3] was applied for determination of the growth kinetics from the evolution of the crystal size distribution (CSD), which was monitored via offline microscopy and additional comparative sieve analysis. Subsequently, parameter estimation was carried out by applying the CSD together with the SLE data, the inline measured concentration, and the temperature. The results of the MSZW and growth kinetics study will be shown and the influence of the presence of NaOH on the growth kinetics of both hydrates highlighted.

[1] S. Ghaffari, M.F Gutierrez, P. Schulze, H. Lorenz, A.S. Morgenstern (2023): **Sodium Hydroxide-based CO_2 Direct Air Capture for Soda Ash Production – Fundamentals for Process Engineering**, *Industrial & Engineering Chemistry Research* 62(19), pp.7566-7579.

[2] M.F Gutierrez, K. Vhora, S. Ghaffari, H. Lorenz, A.S. Morgenstern, P. Schulze (2024): **Experimental study and modeling of a droplet CO_2 absorber for the carbon-negative soda ash production**, *Chemical Engineering*

[3] E. Temmel (2016): **Design of continuous crystallization processes**. PhD diss., *Shaker Verlag Aachen*.



A.P.30. Multi-Label Detection of Crystallization Phenomena Using In-Situ Imaging and Deep Learning

P. Sandhu^{1,2,*}, C. Boyle^{1,3}, C. Tachtatzis², and J. Cardona^{1,2,4}

¹EPSRC Future Manufacturing Research Hub for Continuous Manufacturing and Advanced Crystallization (CMAC), Glasgow, UK;

²Department of Electronic and Electrical Engineering, University of Strathclyde, Glasgow, UK;

³Strathclyde Institute of Pharmacy & Biomedical Sciences (SIPBS), University of Strathclyde, Glasgow, UK;

⁴Department of Chemical and Process Engineering, University of
*parandeep.sandhu.2021@uni.strath.ac.uk

Keywords: Crystallization, Image analysis, Kinetics

In chemical and pharmaceutical manufacturing, data-driven approaches for in-line monitoring of particle attributes are becoming more prevalent to optimise process performance and ensure product quality. These approaches utilise Process Analytical Technologies (PAT) and Artificial Intelligence (AI) to analyse and process data in realtime, identifying patterns and trends that can be used to adjust the manufacturing process. By monitoring key attributes such as particle size, shape, and composition, potential issues can be detected and addressed before they result in defects in the final product, leading to reduced production costs, increased production yields, and improved product quality. Additionally, data-driven approaches provide valuable insights into the root causes of process variability, enabling manufacturers to make targeted improvements and enhance traceability and reproducibility, which are essential for regulatory compliance and maintaining optimal quality control.

In this study, we developed a tool utilising a Convolutional Neural Network (CNN) to categorise eleven distinct crystallisation outcomes, including crystal shapes like needles, plates, elongated, and blocks, as well as to detect images where an object is present but lacks a distinguishable shape (labelled as 'object present'). Furthermore, this tool can identify overly concentrated solutions and other events that can arise during crystallisation processes, such as unidentified floating objects (UFOs), agglomerated crystals, bubbles, and droplets.

Beyond classification, we created a method to estimate kinetic parameters from dynamic experiments, as well as to determine the metastable zone width. By leveraging stratified k-fold cross-validation, we evaluated the full dataset, which allowed us to fine-tune threshold values to maximise the F1-score of the model. By iterating over a range of possible threshold values and evaluating their impact on the F1-score for each label, we identified the optimal threshold settings for each label. This method ensured that our model's predictions were robust and reliable, offering a balanced trade-off between recall and precision, which is crucial in applications where both false positives and false negatives carry significant consequences.

This paper examines the efficacy of a CNN model in integrating PAT data with deep learning in manufacturing. The CNN model exhibited robust performance, with macro, micro, and weighted-average scores surpassing the 80% mark across precision, recall, and F1-score metrics for most labels, underscoring its potential utility in industrial applications. However, the classification performance for certain classes, such as UFOs and bubbles, was notably weaker due to their scarce presence in the dataset—a consequence of the sterile conditions in crystallisation processes where this is kept to a minimum.

A.P.31. Non-linear and Two-level Modell Predictive Controller Design to CMSMPR Crystallizer

L. Balogh*, L. Nagy, A. Egedy, and Á. Barkanyi

University of Pannonia, Department of Process Engineering, Veszprém, Hungary

*balogh.laszlo@mk.uni-pannopen.hu

Keywords: Modell predictive control, CMSMPR crystallizer, two-level control

Following the ever-growing needs and the development of technology, the pharmaceutical industry is also expected to move in the direction of continuously operating technologies. During our work, we carried out investigations related to this need. So, this study consists of two parts: the first is the modelling, and the second is the process control. In the modelling section, we defined a physical system, and we needed to choose what complexity was needed for the control step. The next step is the solution of the model; in the case of Population Balance Equations (PBE), we have more options, such as the method of moment (MOM), Monte Carlo simulations, or finite element solution methods. However, only the MOM is fast enough for the model predictive control (MPC). In the MPC structure, the model of the controlled object and the optimizer are linked together, and the intervention takes place according to the future effect of the manipulated variable. In our case, we used nonlinear MPC (nMPC), so the optimization problem is a conditional extreme value search. Moreover, for every call, the algorithm computes the appropriate intervention. The extreme value search algorithms are not widely implemented in process control software, and the computing power performance of an industrial controller is not enough for these real-time optimization tasks, so the direct application of an nMPC is not realizable yet. So, we made a two-level controller design; in the local level (LL), traditional controllers hold the LL-setpoint, while in the higher level (HL), the MPC algorithm gets the HL-setpoint and calculates the LL-setpoint. The structure of the controller can be seen in Figure 1.

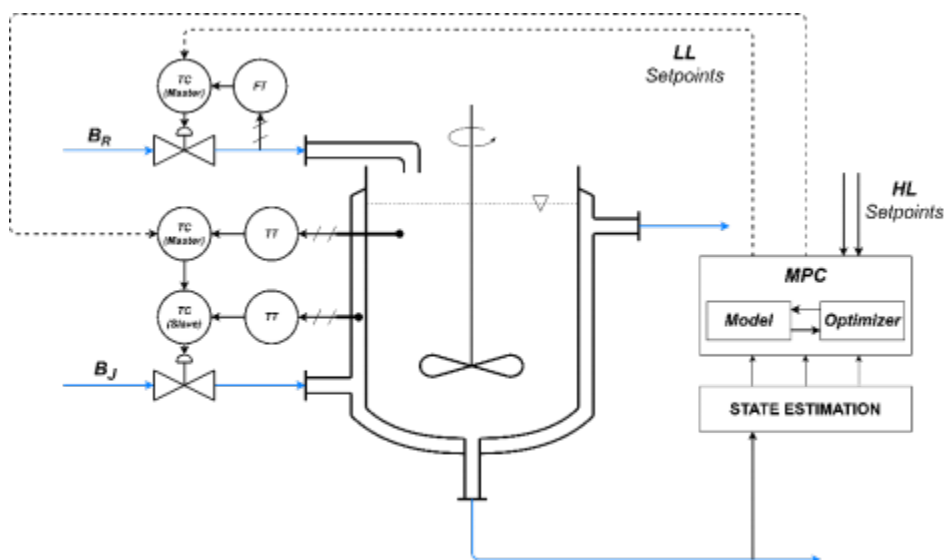

1. Figure: Application of MCP as a higher-level controller

We extend the structure with state estimation. This is necessary because so many output states of the crystallizer are immeasurable, such as moments or the specific distribution. As manipulated variables, we chose the solution's volume flow rate and the cooling medium's volume flow rate.



The choice fell on them because these variables are the easiest to control in industrial practice. The controlled variables are the crystal size's expected value and the crystalline product's volume in the outlet. We expect from this control solution provides more stable and accurate control, and it will be realizable in an industrial environment.

- [1] S. Rohani, M. Haeri, and H.C. Wood (1999): **Modeling and control of a continuous crystallization process Part 1. Linear and non-linear modeling**, *Comput. Chem. Eng.* 23, 263-277.
- [2] B. Szilágyi, Á. Borsos, K. Pal, and Z.K. Nagy (2019): **Experimental implementation of a Quality-by- Control (QbC) framework using a mechanistic PBM-based nonlinear model predictive control involving chord length distribution measurement for the batch cooling crystallization of l- ascorbic acid**, *Chem. Eng. Sci.* 195, 335-346.
- [3] Y. Yang, and Zoltan K. Nagy (2015): **Application of Nonlinear Model Predictive Control in Continuous Crystallization Systems**, *American Control Conference (ACC)*, 4282-4287.



A.P.32. Novel materials and directed crystal engineering for continuous Eutectic Freeze Crystallization (EFC)

M.Matau¹, S. Mgabhi¹, L.Motsepe¹, J.Chivavava¹ and A.E. Lewis^{1*}

¹Univeristy of Cape Town, Cape Town, South Africa

*Alison.Lewis@uct.ac.za

Keywords:

Eutectic Freeze Crystallization, water treatment, ice crystallization, salt crystallization, crystallizer design

Eutectic freeze crystallization (EFC) is a technology with a huge potential to treat brines from various industrial operations, including hypersaline streams such as those from coal mines [1, 2]. This technology can recover not only pure water as ice but individual pure salts, thus having an advantage over evaporative-based methods. As freezing water requires six times less energy than evaporative methods, the operational costs are expected to be low [3].

Although EFC of Reverse Osmosis (RO) retentates of coal-impacted waters has been successful in the laboratory, ice scaling has hindered its implementation on an industrial scale [2, 4-7]. Ice scaling reduces heat transfer rates in EFC because ice has a low thermal conductivity [4]. This results in low ice productivity and long downtime. It is essential that ice scaling be reduced in the EFC of industrial brines to increase the availability of crystallizers, thereby increasing productivity.

Conventional methods for mitigating ice scaling involve the use of mechanical scrapers to remove the ice scale layer from the heat transfer surface of a crystallizer, which increases the availability and productivity of crystallizers. However, due to the high investment and maintenance costs associated with mechanical scrapers, this study explored an alternative method of preventing ice scaling [4, 8]. Recent studies on ice scaling by Lewis and co-workers [5] and Motsepe and co-workers [7] have shown that choosing the Heat Exchanger (HX) material for EFC crystallizers affects ice scaling in EFC significantly. Therefore, this study investigated the use of a smooth, low-surface energy material, Polypropylene Graphite (PP-GR), as a heat exchange material to mitigate ice scaling in EFC of industrial brines.

The first objective was to compare the ice scaling tendency of PP-GR to that of stainless steel during continuous Freeze Crystallization (FC) of the MgSO₄-rich industrial brine under similar operating conditions. The PP-GR material showed lower ice scaling tendency compared to stainless steel. However, using ice-scaling resistant HX materials alone may not eliminate ice scaling, as ice crystallization on solid interfaces such as HX surfaces also depends on solution chemistry.

Given that industrial brines can contain a wide range of solute types such as Na₂SO₄, MgSO₄, CaSO₄, K₂SO₄, etc. at varying concentrations, this study investigated the ice scaling tendency of PP-GR in EFC applications of various brines. The second objective of the study was to investigate the influence of solute type on the resistance of PP-GR to ice scaling in FC applications. The production rate of ice in suspension and the total amount of ice scale on the surface of PP-GR were used as the parameters to evaluate the anti-scaling performance of PP-GR in the FC of brines with various chemistry. Na₂SO₄ and MgSO₄ were employed as solutes, and it was found that PP-GR mitigated ice scaling more effectively in the FC of the MgSO₄ brine compared to that of Na₂SO₄ at equal total ionic molality. This was attributed to higher charge density of the Mg²⁺, which possibly disrupted the prenucleation local structural ordering of the water layers adjacent on the surface of PP-GR, thus delaying ice scaling.



The third objective of the study was to investigate the influence of concentration of solutes in selected industrial brines from coal mining on the anti-scaling performance of PP-GR during continuous FC and EFC. Two brines, rich in Na_2SO_4 and MgSO_4 respectively, were selected for the study. It was found that ice scaling from the FC of the Mg-rich brine using PP-GR decreased significantly at higher brine concentrations, which enhanced the production rate of suspension ice.

Ice-scale free operation was achieved in some instances and detachment of the ice scale layer from PP-GR surface, induced by the brine hydrodynamic force, also occurred in some tests. $\text{Na}_2\text{SO}_4 \cdot 10\text{H}_2\text{O}$ was recovered from the Na-rich brine without scaling on the surface of PP-GR, which meant that the production of salt from hypersaline brines using the material can be sustained. Although ice scaling occurred during the EFC of eutectic Na-rich brines, the production of suspension ice using PP-GR was higher than achieved in previous studies at similar heat transfer driving forces^[9]. It was concluded that PP-GR reduced ice scaling more effectively in concentrated brines, thus allowing higher production rates of ice for longer periods and this was more evident in the continuous FC and EFC of MgSO_4 brines. Thus, the application of PP-GR for continuous FC and EFC of industrial brines showed potential to extend the production of suspension ice.

- [1] Lewis, A.E., J. Nathoo, T.R. Reddy, D.G. Randall, L.M. Zibi, and R.B. Jivanji. Novel technology for recovery of water and solid salts from hypersaline brines: Eutectic Freeze Crystallization. 2010.
- [2] Randall, D.G., J. Nathoo, and A.E. Lewis, A case study for treating a reverse osmosis brine using Eutectic Freeze Crystallization-Approaching a zero waste process. *Desalination*, 2011. **266**(1-3): p. 256-262.
- [3] van der Ham, F., G.J. Witkamp, J. de Graauw, and G.M. van Rosmalen, Eutectic freeze crystallization: Application to process streams and waste water purification. *Chemical Engineering and Processing-Process Intensification*, 1998. **37**(2): p. 207-213.
- [4] Hasan, M., R. Filimonov, J. Chivavava, J. Sorvari, M. Louhi-Kultanen, and A.E. Lewis, Ice growth on the cooling surface in a jacketed and stirred eutectic freeze crystallizer of aqueous Na_2SO_4 solutions. *Separation and Purification Technology*, 2017. **175**: p. 512-526.
- [5] Lewis, A.E., J. Chivavava, L.A. Motsepe, B. Nxiwa, K. Netshiomvani, and N. Zimu, Novel materials and crystallizer design for freeze concentration. *Scientific African*, 2023. **20**.
- [6] Leyland, D., J. Chivavava, and A.E. Lewis, Investigations into ice scaling during eutectic freeze crystallization of brine streams at low scraper speeds and high supersaturation. *Separation and Purification Technology*, 2019. **220**: p. 33-41.
- [7] Motsepe, L.A., J. Chivavava, and A.E. Lewis, A novel, in-situ observation of the initial ice scale layer development on different heat exchanger surfaces during EFC. *Desalination*, 2022. **522**.
- [8] Stamatiou, E., J.W. Meewisse, and M. Kawaji, Ice slurry generation involving moving parts. *International Journal of Refrigeration*, 2005. **28**(1): p. 60-72.
- [9] Spencer, A., J. Chivavava, and A.E. Lewis, Effect of Heat Transfer Driving Force and Ice Seed Loading on the Production of Ice and Salt from a Dilute Brine Treated Using Eutectic Freeze Crystallization. *Minerals*, 2022. **12**(9): p. 1094.



A.P.33. Polymorphic change induced by secondary nucleation in single-seed crystallizations with gamma glycine.

Lucas Nahas^{1*}, Jan Sefcik¹, Mark Haw¹, and Mei Lee²

¹ Department of Chemical and Process Engineering, University of Strathclyde, Glasgow, UK;

²Drug Substance Development - Materials Science- Medicine Development & Supply, R&D, GSK,

Stevenage, UK

*lucas.nahas-martinez.2017@uni.strath.ac.uk

Keywords: Secondary nucleation, seeding, polymorphism, fluid shear.

Seeding is the most commonly used nucleation control strategy in the pharmaceutical industry. This technique relies on the addition of seeds of particular mass, size and polymorphic form into a solution in its metastable zone to promote an accelerated rise in the formation of new crystals. Seeded-crystallizations can offer numerous advantages apart from earlier nucleation when compared to traditional unseeded methods. These include a higher degree of process control, increased yields at lower supersaturation levels, and improved consistency in crystal quality attributes. Nevertheless, seeding can sometimes fail to target a specific polymorph due to the poorly understood nature of competing processes like secondary nucleation and growth.

Recent research has primarily focused on control strategies that promote controlled growth of seeds [1]. However, growth-dominating seeding is not always feasible due to limited API availability, which leads to unavoidable secondary nucleation. In secondary nucleation fine particles are generated in the solution due to the presence of seeds, which can potentially yield new crystals with different polymorphic forms. Therefore, a better understanding of the influence of secondary nucleation on polymorphic outcome is required. This phenomenon can be triggered by either mechanical impact, causing detachment of fragments from parent crystals, or fluid shear, resulting in displacement of solute clusters from seed surfaces. Therefore, the development of new experimental methods capable of distinguishing these effects is essential for comprehending the interplay between secondary nucleation and polymorphism.

In this study, we isolated the effect of fluid shear on secondary nucleation by fixing a single crystal of glycine in a stirred vial, as shown in Figure 1. Gamma glycine was selected as our model compound due to previous reports of polymorphic change upon impact onto a surface within a supersaturated solution [2]. Although promising, distinguishing between attrition and fluid shear effects was challenging, as seed impact often caused surface abrasion. To address this, we adopted a "seed-on-a-stick" approach instead, allowing us to separate the influence of fluid hydrodynamics from attrition effects. Our experiments consistently yielded a crystalline product of the metastable form of glycine, alpha, confirming the polymorphic change induced by fluid shear-driven secondary nucleation.

[1] Z. Nagy (2017): **Crystallization Control Approaches and Models**, in *Engineering Crystallography: From Molecule to Crystal to Functional Form.*, Springer, Dordrecht, p. 289-300.

[2] A. S. Yuqing Cui (2014): **Experimental evaluation of contact secondary nucleation mechanisms**, *Crystal Growth & Design*, vol. 14(10), p. 5152-5157.

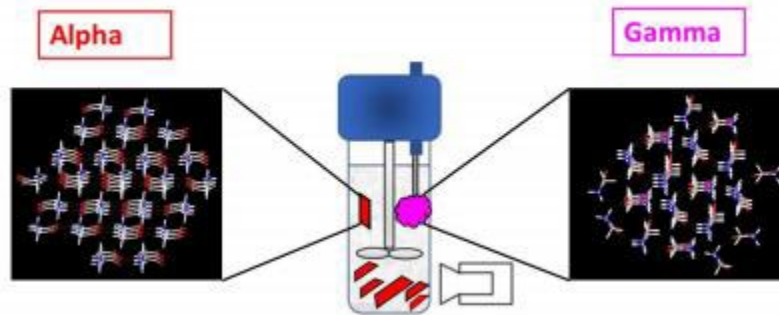

Figure 1: Effect of fluid shear on the polymorphism of a single gamma glycine seed

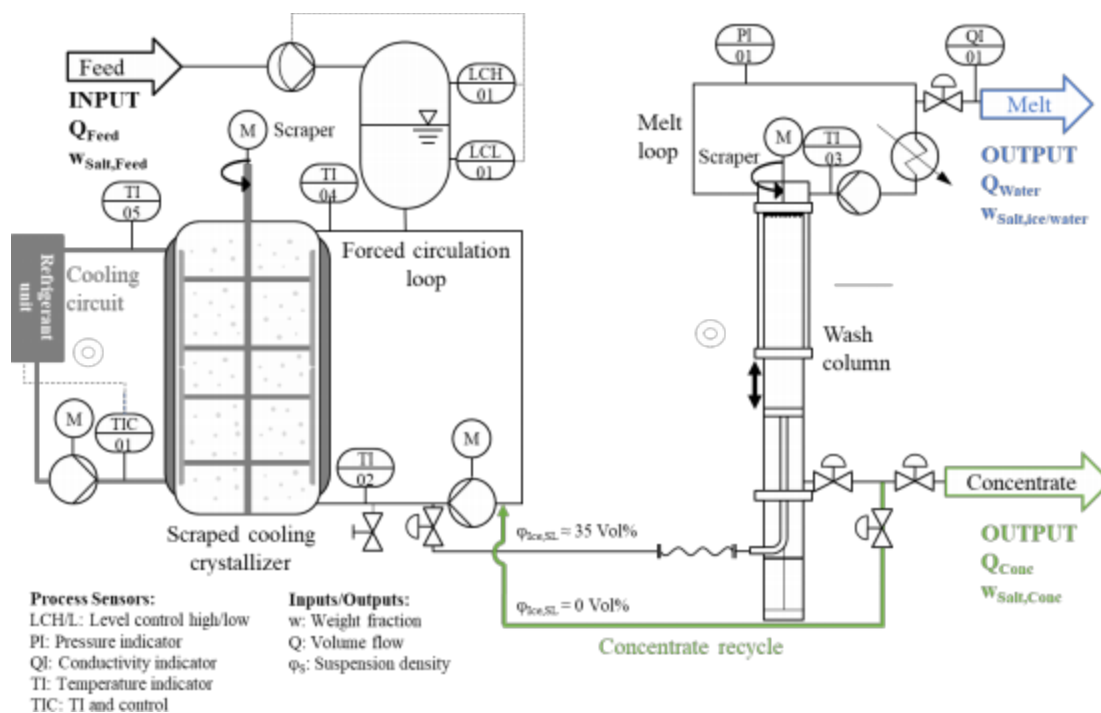

Figure 1: Schematic illustration of the freeze concentration plant (designed by the SULZER CHEMTECH AG) containing the crystallization unit consisting of the scraped cooling crystallizer with a forced circulation loop, the solid-liquid separation unit consisting of a mechanical piston-type wash column with melt loop, and the recycle stream for the concentrate.

For a diluted binary NaCl-water system (1 wt% NaCl), the crystallization and the wash column were characterized regarding the impact of the process parameters and a stable operating window. Highly pure water with deionized water quality ($w_{\text{Salt,ice/water}} \approx 0$) was produced and by utilizing a concentrate recycle the yield of water per feed solution $Q_{\text{Water}}/Q_{\text{Feed}}$ was increased from 35 % to 65 % at a constant ice density φ_{Ice} of 35 vol%. To show the transferability of the findings from the well-known simple binary model system (aqueous NaCl solution) a more complex aqueous salt mixture with magnesium sulfate and sodium chloride is used and the results regarding the yield and purification will be presented.

- [1] J. Ulrich, H. Glade (2003): **Melt crystallization. Fundamentals, Equipment and Applications**, Shaker, Aachen.
- [2] D. G. Randall, J. Nathoo (2015): **A succinct review of the treatment of Reverse Osmosis brines using Freeze Crystallization**, *J. Water Process Eng.*, 8, 186.
- [3] S. Rahman (2020): **Handbook of Food Preservation**, CRC Press Taylor & Francis Group, London.



A.P.34. Recovery of Ni, Co and Mn methane sulfonate hydrates by liquid antisolvent crystallization and eutectic freeze crystallization

N. Snehashis¹, N. Osmanbegovic¹, M. Svärd¹, and K. Forsberg^{1*}

¹KTH Royal Institute of Technology, Stockholm, Sweden

*kerstino@kth.se

Keywords: liquid antisolvent crystallization (LAC), eutectic freeze crystallization (EFC), methane sulfonate acid (MSA)

In this work, we focused on the liquid antisolvent crystallization (LAC) process and eutectic freeze crystallization (EFC) process for the recovery of pure Ni, Co and Mn methane sulfonate hydrates from aqueous MSA solutions. Ni, Co and Mn of high purity are crucial elements for Li-ion batteries which projected demand is about to increase 14-fold by 2030 to tackle the challenges of the European Union's energy and resource supply chain independence [1]. Methane sulfonic acid (MSA) is a promising green organic solvent that can be a potential replacement for sulfuric acid for sustainable and circular hydrometallurgical processes [2,3]. Investigated synthetic feed solutions were generated by dissolving Ni(OH)₂, Co(OH)₂ and MnCO₃ in aqueous MSA solutions of various molar strengths at room temperature. In the case of the LAC process, a number of water-miscible organic solvents, i.e., acetone, isopropanol and acetonitrile (ACN) were screened. ACN was found to be a promising antisolvent for precipitating out Ni, Co and Mn MSA hydrate salts from the synthetic aqueous MSA solutions. Different solid forms of Ni, Co and Mn MSA salts were crystallized depending on the process conditions. Previously, EFC has been reported as an efficient method for Ni and Co recovery from sulfate systems [4]. In this study, EFC was investigated as another energy-efficient and antisolvent-free approach to crystallize Ni, Co and Mn MSA hydrate salts from synthetic feed solutions. Then, the freezing points of these feed solutions, purities and yields of the crystallized metal MSA salts were determined. Finally, the morphology and solid-state properties of the crystallized metal MSA salts were analyzed.

- [1] IEA (2024); **Batteries and Secure Energy Transitions**, <https://www.iea.org/reports/batteries-and-secure-energy-transitions>
- [2] M.D. Gernon, M. Wu, T. Buszta and P. Janney (1999): **Environmental benefits of methanesulfonic acid**, *Green Chem.* 1, 127–140.
- [3] K. Binnemans and P.T. Jones (2023): **Methanesulfonic Acid (MSA) in Hydrometallurgy**, *J. Sustain. Metall.* 9, 26–45.
- [4] Y. Ma, M. Svärd, X. Xiao, S.A. Sahadevan, J. Gardner, R.T. Olsson and K. Forsberg (2022): **Eutectic freeze crystallization for recovery of NiSO₄ and CoSO₄ hydrates from sulfate solutions**, *Sep. Purif. Technol.* 286, 120308.



A.P.35. Salt screening of racemic and Ibuprofen with inorganic bases.

E. Collet Salvet^{1,2*}, B. Robert² and G. Coquerel¹.

¹ SMS, UR 3233, University Rouen Normandie, 76000 Rouen, France

² Early Development, Sanofi, quai Jules Guesde, 94403 Vitry-sur Seine France

*elisa.collet@univ-rouen.fr or elisa.collet@sanofi.com

Keywords:

Active pharmaceutical ingredients (APIs) are commonly administered to patients as solid-state formulations, which offer stability and compactness, with a convenient format of delivery. The production of APIs in various solid forms, such as single components (e.g., stable, metastable and amorphous phases) or multicomponent systems (e.g., solvates, co-crystals, salts or hybrids), yields distinct physicochemical properties. These properties significantly impact the drug's bioavailability, manufacturability, solubility, and stability, thus influencing its overall performance in pharmaceutical processes.[1] Subsequently, salt formation has become a prevalent technique for ionizable compounds in pharmaceutical development. Despite over 50% of approved APIs being marketed in their salt forms, [2] challenges persist in the industry to achieve the desired results within the time limitation enforced in industry.

This work aims at creating an experimental database serving as a tool to aid industrial professionals in their salt screening process. The limit of rationalization the counter ion's choice depending on the nature of the API and the targeted behavior will be drawn and study to hopefully highlight trends and patterns. The initial step focuses on presenting the salt screening process used through the case of racemic Ibuprofen. It was firstly selected because of its global commercial significance [3, 4] and extensive literature on reported salt formations (e.g., with sodium, lysine, and arginine) [3, 4]. Three inorganic counterions: Calcium, Magnesium and Potassium ions were selected. Without any: time, solvent or synthetic method restriction, promising results had been observed, including the characterization of multiple salts. Parameters such as crystalline structure, solubility, hygroscopicity, and thermal stability are studied to provide a comprehensive overview of the obtained salts. The same methodology will be then extended the pure enantiomer and to other APIs (e.g., Clopidogrel, Zolpidem, Ketoprofen, etc.) and counterions broadening the database with a diverse array of data points.

[1] S. R. Byrn and J.-O. Henck. (2012): **Optimizing the physical form – opportunities and limitations**, *Drug Discov. Today Technol.*, vol. 9, n° 2, Art. n° 2.

[2] C. Saal and A. Becker. (2013): **Pharmaceutical salts: A summary on doses of salt formers from the Orange Book**, *Eur. J. Pharm. Sci.*, vol. 49, n° 4, Art. n° 4.

[3] Armitage, B. J., Lampard, J. F., & Smith, A. (2001): **Composition of S(-) sodium ibuprofen**. *US Patent No. 6,242,000 B1*.

[4] Bruzzese, T., Ferrari, R. and SPA-Socita Prodotti Antibiotici. (1981): **Method of relieving pain and treating inflammatory conditions in warm-blooded animals**. *US Patent No. 4279926*.



A.P.36. TiNb_2O_7 formation through a simple precipitation route

C. N. Silva^{1*}, G. C. Silva¹, G.T.M. Alvarenga¹, B.V.D. Leblon¹, C. R. Souza¹, and S. D. F. Rocha^{1*}

¹Universidade Federal de Minas Gerais, Belo Horizonte, Brazil

*carolinans@ufmg.br; sdrocha@demin.ufmg.br

Keywords: titanium niobium oxides, precipitation, phase characterization

Niobium-based oxides are excellent option for anodes in lithium-ion batteries. The niobium's multiple oxidation states enable the insertion of lithium ions into the electrodes structure [1]. Improvement of the material's properties is obtained by associating titanium with niobium in a structure known as TNO (titanium niobium oxide), which exhibits different compositions and crystalline phases, such as TiNb_2O_7 , $\text{TiNb}_{24}\text{O}_{62}$, $\text{Ti}_2\text{Nb}_{10}\text{O}_{29}$, among others [2]. The TNO synthesis method influences the particles properties as well as their performance [3]. In this work, aqueous precipitation of TNO was carried out using a titanium, niobium and potassium aqueous solution (pH=14) derived from the treatment of niobium and titanium oxides with KOH. The supersaturation of the solution was reached by addition of nitric acid, and the effect of pH on the solid formed was evaluated in the range pH 0 to pH 6. Precipitation was favored at lower pH and the particles formed agglomerates. The solids were characterized by XRD, particle size, Raman, XRF and SEM. At pH 2, the precipitates were amorphous, with mean diameter of 5.19 μm . After calcination at 900°C for 3h, it was observed the formation of different phases in the solid obtained at different pHs. The precipitate obtained in pH 2, after calcination, formed a crystalline structure of TiNb_2O_7 . Therefore, a route including the precipitation of an amorphous phase at low pH and its subsequent calcination generated a single monoclinic crystalline phase of TiNb_2O_7 .

[1] S. Zhu, J. Mei, W. Zeng, S. Lu, M. Su, H. Zhan, Y. Huang, S. Yang, Y. Liu (2024): **Facile synthesis of TiNb_2O_7 anode material by KOH sub-molten salt method for lithium-ion batteries**, *Materials Letters* 360, 135980, doi: 10.1016/j.matlet.2024.135980.

[2] T. Yuan, L. Soule, B. Zhao, J. Zou, J. Yang, M. Liu, S. Zheng (2020): **Recent Advances in Titanium Niobium Oxide Anodes for High-Power Lithium-Ion Batteries**, *Energy Fuels* 34, 13321–13334, doi: 10.1021/acs.energyfuels.0c0273.

[3] K. Ise, S. Morimoto, Y. Harada, N. Takami (2018): **Large lithium storage in highly crystalline TiNb_2O_7 nanoparticles synthesized by a hydrothermal method as anodes for lithium-ion batteries**, *Solid State Ionics* 320, 7–15, doi: 10.1016/j.ssi.2018.02.027.



A.P.37. Using CO₂ to precipitate MnCO₃ for a lithium-ion battery precursor

T.Sibanda¹, S.Mgabhi¹, J.Chivavava¹ and A.E. Lewis^{1*}

¹Univeristy of Cape Town, Cape Town, South Africa

*Alison.Lewis@uct.ac.za

Keywords:

Lithium-ion batteries, carbonate precipitation, manganese, CO₂ gas

South Africa has the world's largest reserves of manganese (Mn), and it is predicted that demand will significantly increase as Mn is a core requirement in new generation electric vehicle batteries.

High Purity Manganese, also known as battery grade manganese, is needed in the form of High Purity Manganese Sulphate Monohydrate (HPMSM), MnSO₄·H₂O. However, producing HPMSM from the Mn ore is conventionally achieved using electrowinning to recover Mn from the leachates, followed by redissolution of the recovered Mn metal in sulphuric acid. This process is energy intensive, hence has a large carbon footprint and its own technical challenges. This study explored an alternative, novel method of recovering Mn from leach liquors via precipitation. This involves precipitation of MnCO₃ using a carbonate source, in order to separate the Mn from the impurities in the leach liquor. This pure carbonate salt can then be dissolved and recrystallized as HPMSM. Existing work on precipitation of MnCO₃ from waste liquors has used ammonium bicarbonate (ABC) as the carbonate source^[1].

An added advantage of this route is that there is potential to use CO₂, a major greenhouse gas, as the carbonate source, saving costs as well as designing a more environmentally friendly process.

Although these concepts have been tested in low-grade waste streams^[1-3], only partial success has been achieved and the concept has not yet been applied to manganese salt production from leach liquors of primary ores.

The first phase of the research project was a desktop study, to develop a conceptual process design; to identify operating conditions and to generate an overall material balance for a potential CO₂ precipitation process. This phase was carried out using the thermodynamic modelling package OLI Stream Analyser^[4] which uses the revised Helgeson-Kirkham-Flowers (HKF) model for the calculation of standard thermodynamic properties of aqueous species and the frameworks of Bromley, Zemaitis, Pitzer, Debye-Hückel, and others for the excess terms. The thermodynamic modelling investigated the following scenarios:

1. Effect of pH on CO ₂ solubility
2. Effect of pH on theoretical Mg, Mn and Ca yields.
3. Effect of pressure on CO ₂ solubility with pH control at pH = 6.6
4. Effect of pressure on yield of MnCO ₃ at a range of pH values

The modelling showed that the theoretical yield of MnCO₃ using CO₂ is at least equivalent to that using ammonium bicarbonate (ABC). The modelling successfully identified the necessary pH conditions for optimum dissolution of CO₂, maximum precipitation of MnCO₃ and minimum co-precipitation of Mg and Ca. This condition is $6.6 < \text{pH} < 7.9$.



The second phase was a bench scale laboratory study to develop a CO₂-based precipitation process on the laboratory scale with accompanying conceptual design. In this stage, the kinetic effects (which cannot be modelled using the desktop thermodynamic software) were examined. The focus here was on:

- a. Establishing the effect of using gaseous CO₂ as a precipitant on the recovery and purity of the produced MnCO₃ salt.
- b. Establishing the effect of CO₂ pressure on the recovery and purity of the product.

A bench scale laboratory reactor with pH control and CO₂ sparger designed for optimum gas liquid mass transfer was successfully commissioned and operated. A CO₂-based precipitation process with an accompanying conceptual design was developed at the laboratory scale. This process generated kinetic information (i.e., the effect of reaction time) and showed that increasing the run time significantly affected the yield, from 4% at one hour to 94% at 11 hours. Increasing the CO₂ pressure to 2 barg significantly improved the kinetics, with a yield of 72% at 1 hour run time.

The process resulted in the rejection of Mg and Ca of 99 and 98%, respectively, from the product. Thus, high purity MnCO₃ product was obtained after washing which showed that Mn was selectively recovered from a leach liquor containing both Ca and Mg impurities.

- [1] Lin, Q.-q., et al., *Separation of manganese from calcium and magnesium in sulfate solutions via carbonate precipitation*. Transactions of Nonferrous Metals Society of China, 2016. **26**(4): p. 1118-1125.
- [2] Yu, C., et al., *A novel approach for recovery of manganese from on-site manganese-bearing wastewater*. Journal of Cleaner Production, 2019. **227**: p. 675-682.
- [3] Wang, N., et al., *Recovery of soluble manganese from electrolyte manganese residue using a combination of ammonia and CO₂*. Hydrometallurgy, 2016. **164**: p. 288-294.
- [4] OLI Systems Inc, *OLI Studio Stream Analyzer, v11.5 (Build 1.7) 15-Sep-2022*. Morris Plains, New Jersey, 2022.



A.P.38. Water purification in a freeze concentration process

R. Heming¹, E. Temmel², K. Wohlgemuth^{1*}

¹Laboratory of Plant and Process Design, TU Dortmund University,
Dortmund/Germany;

² Sulzer Chemtech Ltd, Allschwil/Switzerland
*kerstin.wohlgemuth@tu-dortmund.de

Keywords: Suspension freeze concentration, solid-liquid separation, purification, wash column, water treatment

Suspension freeze concentration (FC) is a technology for dewatering aqueous solutions by crystallization of water in scraped heat exchangers^[1]. With sub-zero process conditions, the technology is favorable for thermally sensitive components like liquid food as it preserves flavor, nutrients, and color. Additionally, the significantly lower latent heat of crystallization than evaporation provides promising energy saving potential. Yet, most water recovery processes employ evaporation-based technologies since they can be operated with inexpensive energy sources, like fossil fuel. However, with growing trends towards renewable energy, FC could be an alternative for dewatering processes like desalination and wastewater treatment^[2] since only electricity is needed. To utilize the full potential of FC, the solid-liquid separation and purification of ice crystals are essential, which are efficiently combined in continuously operated wash columns. However, the complex operation of these columns and their connection to the crystallization unit requires a fundamental understanding of the basic underlying mechanisms.^[1,3]

FC is separated into the crystallization and wash column unit (see Figure 1). From a feed tank, a melt is fed into a forced circulation cooling crystallizer, where ice crystals are continuously formed at the cooled surfaces and are directly suspended by scraper blades. Subsequently, the suspension is withdrawn, and the solid phase is separated as well as washed in a piston-type wash column in a counter-current manner. The downward movement of the piston feeds the suspension through an internal feed line into the column. The subsequent upward movement is similar to a common pressure filtration. The piston head, a special type of a filter screen, separates the concentrate and compresses the solid phase to form an ice bed. In the top section, pressurized wash liquid is pushed through the ice bed and displaces adhering mother liquor from the crystal surfaces. Finally, the ice bed is scraped off, and the crystals are melted to obtain water, which is partly fed back as wash liquid and partly discharged as pure product. The concentrated liquid phase exits the column via the filter screen on the piston head in the bottom section of the wash column.