



HAL
open science

Condition Assessment of Insulation Systems Through Electric Field Mapping Using Electro-Optic Sensors

Sneha Satish Hegde, Gwenaël Gaborit, Ayyoub Zouaghi, Lionel Duvillaret,
Christian Vollaire

► **To cite this version:**

Sneha Satish Hegde, Gwenaël Gaborit, Ayyoub Zouaghi, Lionel Duvillaret, Christian Vollaire. Condition Assessment of Insulation Systems Through Electric Field Mapping Using Electro-Optic Sensors. 2024 IEEE 5th International Conference on Dielectrics (ICD), Jun 2024, Toulouse, France. pp.1-4, 10.1109/ICD59037.2024.10613258 . hal-04695877

HAL Id: hal-04695877

<https://hal.science/hal-04695877>

Submitted on 12 Sep 2024

HAL is a multi-disciplinary open access archive for the deposit and dissemination of scientific research documents, whether they are published or not. The documents may come from teaching and research institutions in France or abroad, or from public or private research centers.

L'archive ouverte pluridisciplinaire **HAL**, est destinée au dépôt et à la diffusion de documents scientifiques de niveau recherche, publiés ou non, émanant des établissements d'enseignement et de recherche français ou étrangers, des laboratoires publics ou privés.

Condition Assessment of Insulation Systems through Electric Field Mapping using Electro-optic Sensors

Sneha Satish Hegde ^{1,3,*}, Gwenaël Gaborit ^{2,3}, Ayyoub Zouaghi ¹, Lionel Duvillaret ³, Christian Vollaire ¹

¹ Ecole Centrale de Lyon, INSA Lyon, Université Claude Bernard Lyon 1, CNRS, Ampère, UMR5005, 69130 Ecully, France

² CROMA laboratory, Université Savoie- Mont-Blanc, 73376 Le Bourget-du-Lac cedex, France

³ Kapteos SAS, Bât. Cleanspace 354 voie Magellan, Z.A. Alpespace, 73800 Sainte-Hélène- du-Lac, France

* Corresponding author : sneha-satish.hegde@ec-lyon.fr

Abstract- The performance of outdoor insulators directly affects the reliability of power supply. However, their insulation performance is highly dependent on the environmental factors such as pollution. Evaluating the extent of pollution on insulators is essential for maintaining high power quality standards. This study explores a novel approach to assess the severity of pollution and its impact on insulation integrity of composite insulators, utilizing Electro-Optic (EO) sensor technology for electric field mapping. Given the challenges associated with collecting and analyzing such data during power line inspections, this research seeks to evaluate the feasibility of EO sensor-based diagnostics for preventive maintenance. The objective is to identify and map variations in electric field associated with pollution-induced insulation degradation. Furthermore, this study investigates the distribution of two components of the electric field under different contamination scenarios, taking into account the position of the sensor and the applied voltage. The results demonstrate a significant influence of the pollution deposition on the measured electric field values, highlighting the efficiency of the EO sensor in accurately assessing insulation condition. These findings provide valuable insights for implementing targeted maintenance strategies, ultimately enhancing the longevity and reliability of high-voltage equipment and fortifying resilience within the energy sector.

I. INTRODUCTION

Insulators serve as crucial elements in power systems, ensuring the smooth operation of transmission lines by isolating conductors from grounded structures, and providing essential mechanical support. While traditional porcelain or glass insulators have long been employed in these roles, composite insulators have gained traction due to their several advantages such as lightweight construction, cost-effectiveness, and superior performance in environments prone to contamination [1], [2]. However, despite their advantages, composite insulators are susceptible to various forms of damage and deterioration that can compromise their effectiveness.

Among the primary challenges faced by composite insulators is the occurrence of tracking and erosion along their surfaces, which could also be because of the existing undetectable manufacturing defects. Tracking arises when conductive paths form due to the presence of environmental contaminants or moisture, leading to surface discharges that can impair the insulator's electrical properties [3]. These issues can result in structural weaknesses, including brittle fracture or burn-out,

ultimately leading to disruptions in power supply. The vulnerability of composite insulators underscores the necessity for thorough inspection and maintenance practices. While visual inspections have traditionally been the mainstay for assessing insulator condition, they may not always detect internal defects or subtle signs of degradation [4], [5]. Moreover, contamination by industrial or natural pollutants can significantly impact insulator performance by reducing surface hydrophobicity and promoting surface discharge activity. Understanding how these environmental factors influence electric field distribution can aid in predicting flashover events and optimizing maintenance schedules [6]. Consequently, there has been a growing interest in leveraging advanced diagnostic techniques to supplement visual inspections and provide a more comprehensive evaluation of insulator health.

One such technique is electric field mapping utilizing electro-optic (EO) sensors [7]. These sensors enable the measurement and visualization of electric field variations around insulators, offering valuable information that can help to assess their performance and integrity, and evaluate the insulation degradation severity [8], [9]. By detecting and mapping electric field fluctuations, these sensors could be helpful for the characterization of the insulation degradation and the diagnostic of the defaults [10], [11]. Moreover, EO sensor-based diagnostics have the potential to enable proactive maintenance practices, allowing utilities to address issues before they escalate into costly failures.

The aim of this research is to investigate the possibility of the use of electric field mapping to investigate the severity of environmental factors such as salt water deposition on composite insulators. In the present experimental work, two electric field components are measured along the composite insulator under different pollution conditions using EO electric field mapping techniques. The research intends to investigate the possibility of using such sensors to evaluate the pollution severity and perform preventive maintenance to enhance the resilience and reliability of high-voltage equipment in power transmission and distribution networks.

II. EXPERIMENTAL SETUP

The proposed experimental setup replicates real-life scenarios involving installed insulators exposed to various environmental pollutants. Fig. 1 illustrates the schematic diagram of the experimental setup, which is divided into a high

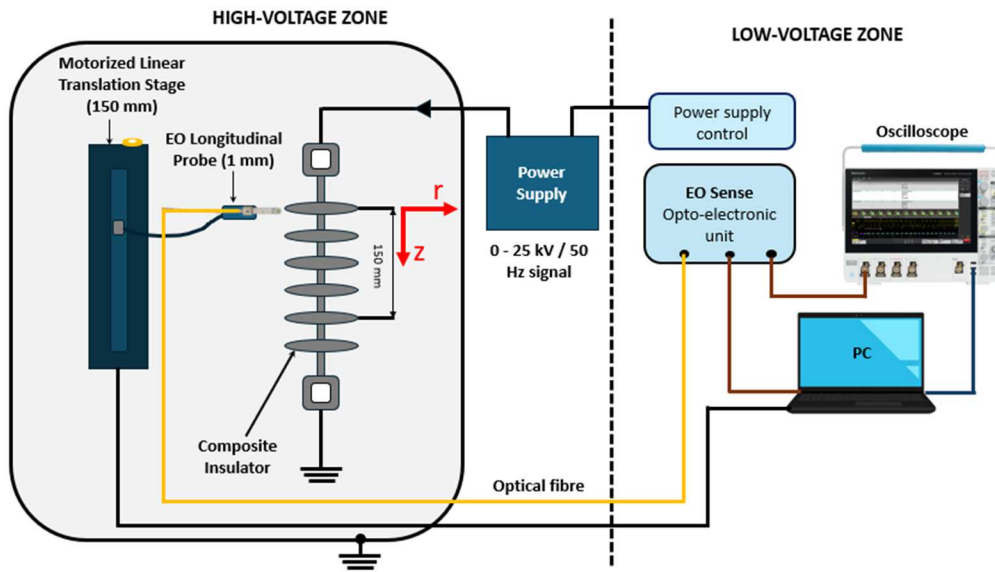

Fig. 1 Schematic diagram of the experimental setup using EO sensor and the linear translation stage

voltage zone and a low voltage zone. The high voltage zone is an enclosed grounded metallic space designed to minimize external disturbances and ensure security. A power supply placed in the high voltage zone provides up to 25 kVrms, 50 Hz AC voltage. In contrast, the low voltage zone hosts the control unit for the linear translation stage, the opto-electronic unit for the EO sensor, the power supply control, and the oscilloscope. Various types of pollutants and sensor positions were considered for the experiments. The measurement results were subsequently analyzed, and comparisons were made between the clean insulator and the insulator subjected to pollutants. To create pollution conditions, water, and salted water (with a concentration of 40 g/liter to mimic seawater salt content) were deposited onto the insulators. The insulator polluted with salted water was dried before experiments, leaving visible white salt traces, as depicted in in Fig. 2.

An electric field EO sensor from Kapteos [7-9] is used for electric field measurement. The EO sensor, together with a translation stage, allows to characterize and map the electric field deformation caused by the pollution deposition on the insulator. The full-dielectric packaging of these probes sets

them apart, as they can measure the electric field nearby HV sources without any risk.

The EO sensor employed was a longitudinal sensor (EL5) with a 5 mm length crystal and covers a frequency bandwidth from 30 Hz up to 10 GHz. The positioning of the EO sensor with respect to the device under test is shown in the Fig. 2 for the E_r field component measurement. The sensor position is modified by directing it vertically for E_z component field measurement. The distance between the probe and the insulator is fixed at 5 mm.

The EO sensor is moved using a motorized linear translation stage with a length of 150 mm. The velocity of the translation was fixed at 5 mm/s. The translation stage control was achieved using commercially available Thor Labs software. Multiple measurements were taken by moving the EO sensors between the plates and conducting linear measurements from the top to the bottom of the insulator. Although, the insulator consists of 6 plates, measurements could only be conducted between the 1st and the 5th plates due to the 150 mm limit of the linear translation stage. The electric field signals measured using the EO sensors are recorded using the oscilloscope (Keysight MSO-X 3104A, 1 GHz Bandwidth and 5 GS/s) and

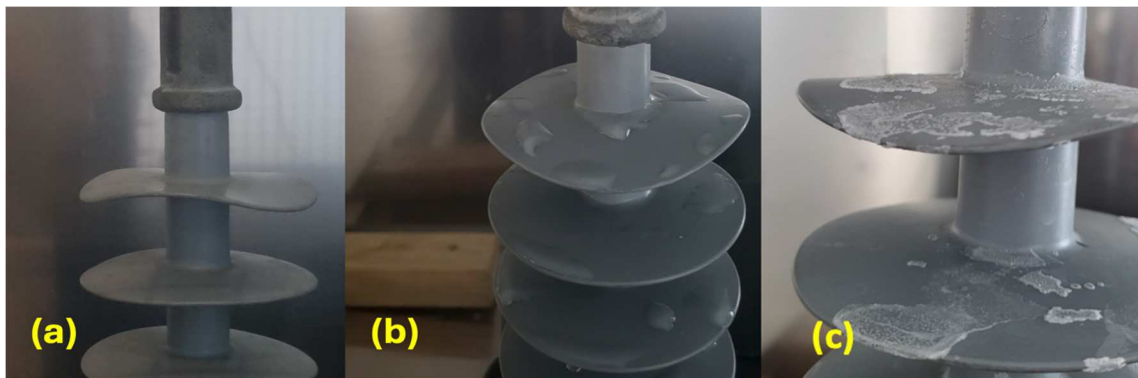

Fig. 2 Insulator simulating the different environmental conditional (a) Clean Insulator, (b) Water pollutant, (c) Dried salt water pollutant

analyzed in the time and frequency domain. A study between the electric field distribution along the z axis with and without pollutants is presented.

III. EXPERIMENTAL RESULTS

In this part, we present the results of the measurements of both E_r and E_z field components in different scenarios such as the clean insulator and the presence of water and dried salt water pollutants. In these experiments, the high voltage is connected in the top side of the insulator, and the translation of the sensor starts at the position 0 mm which corresponds to the first topmost plate and ends at the position 150 mm which is next to the 5th plate. The distance between the plates is approximately 37.5 mm. All the experiments were conducted using a voltage of 25 kVrms, 50 Hz AC voltage.

A. Clean Insulator

Fig. 3 presents the EO sensor output sinusoidal signal, which is an image of the E_r electric field component in static state at a specific position (3rd plate). The raw measurement signal of the EO sensor in radial position as a function of the measurement time and the sensor position from 0 to 150 mm is shown in the Fig. 4. In these measurements, the insulator was clean. When the sensor is translated from the position 0 mm to the position 150 mm, the magnitude of the measured signal decreases because the sensor goes far from the HV side. The antenna factor (AF), being the linear link between the actual field component and the measured output voltage, has been previously determined thanks to a specific calibration. AF has been used to obtain the absolute field spatial distribution of the further presented results.

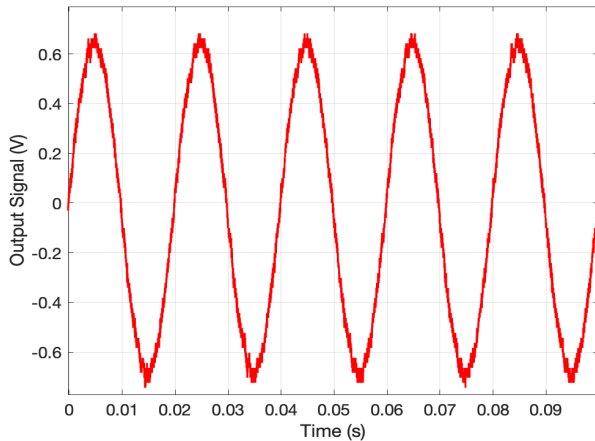

Fig. 3 Raw temporal measurement signal of a clean insulator over time at a fixed position

Fig. 5 presents the variation of the root mean square (RMS) value of the electric field components as a function of the position of the sensor in the case of clean insulator. Both E_r and E_z components are higher at the top of the insulator, and then they decrease when the sensor move downer and vice-versa in the case of the electric field angle. At the position 0 mm (topmost plate), the RMS value of the E_r component of the

electric field is higher than that of the E_z component, however, it decreases quickly with the position of the sensor to become lower than the E_z component.

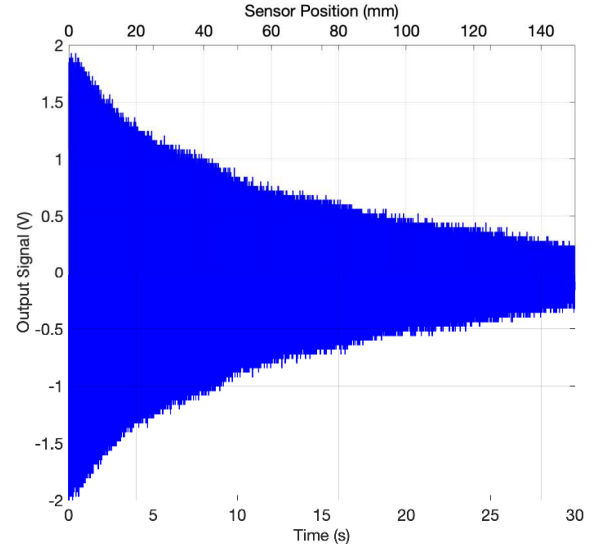

Fig. 4 Raw measurement signal depicting mapping of a clean insulator over time (s) and sensor position (mm)

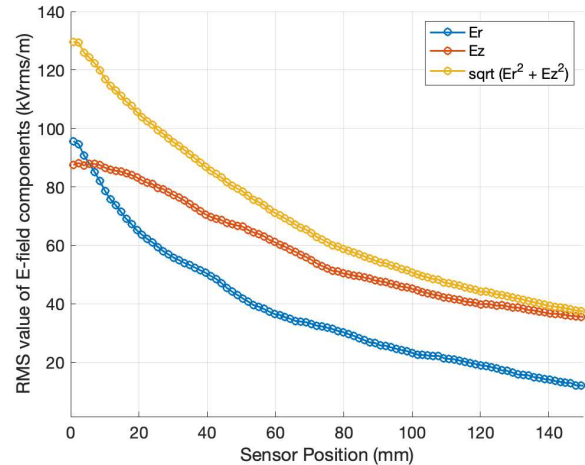

Fig. 5 RMS value and angle of electric field components as a function of the sensor position for a clean insulator

B. Impact of the pollution on the electric field

Fig. 6 illustrates a comparison of the RMS profiles of the E_r electric field component in relation to the positions of the sensor ranging from 0 to 150 mm when moved along the z axis, for both clean, water polluted, and dried salt water polluted composite insulator. Notably, the use of water as a pollutant results in an electric field increase of nearly double that of the clean condition and also that of a dried salt water pollutant. The peak in electric field value occurs next to the first plate which is close to the HV electrode, with smaller peaks observed at the tip of each plate. The peaks in the E_r profile with water pollution are slightly shifted, this may be caused by the non-homogeneity of the water pollution. These results clearly demonstrate that the insulator pollution can increase

significantly the E_r electric field value, this latter is also sensitive to the pollution type. Similarly, in the Fig. 7 we have the RMS value of the E_z field component for the different pollution cases. Even here we observe significant impact when water is used as a pollutant, the E_z component in this case is higher. The E_z component seems to be lower at dried salt water pollution. From both figures Fig. 6 and Fig. 7, we can clearly observe that the maximum value of E_r electric field component is higher than that of the E_z component, and it is located near to the closest plate to the HV connection. On the other hand, the highest value of the E_z is located between the 1st and the 2nd plate under water pollution.

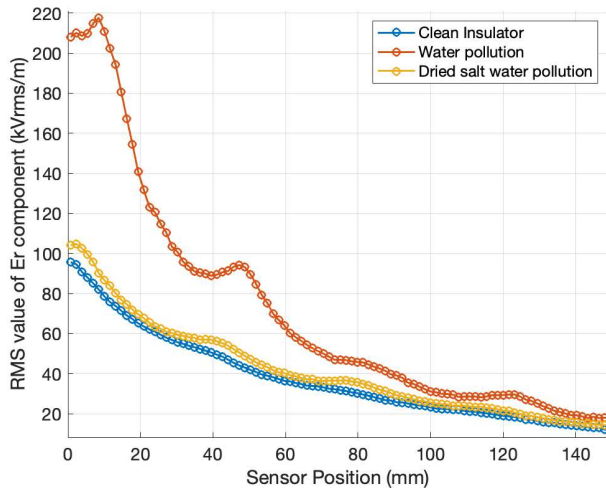

Fig. 6 RMS value of E_r electric field component as a function of the sensor position for different pollution cases

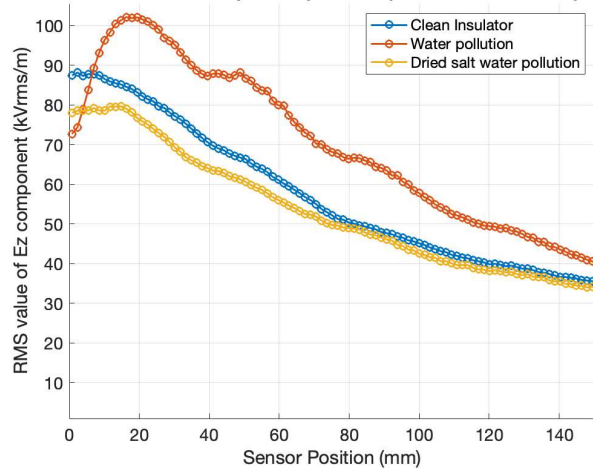

Fig. 7 RMS value of E_z electric field component as a function of the sensor position for different pollution cases

IV. CONCLUSION

In the present paper, EO sensors were used to perform an electric field mapping and study the distribution of electric field on composite insulator with various types of artificial pollutions. The results demonstrate the effectiveness of EO sensors in characterizing the pollution severity on the

insulators. Higher RMS values of the electric field (for both e-field components) have been obtained under water pollutant. Radial field component seems to be more sensitive to the pollution of the composite insulator. Using the calculation of RMS value of the electric fields, relationship between angle of the electric field with respect to the position of the sensor was established. By utilizing electric field mapping, this research offers a valuable tool for preventive maintenance, improving the reliability of HV equipment, and ultimately contributing to the advancement of HV technology.

ACKNOWLEDGMENT

This work has been supported financially within the program: France Relance. Authors would like to thank the French ministry of higher education, research and innovation (MESRI), and the national research agency (ANR) for supporting the project ELECOP.

REFERENCES

- [1] L. Maraaba, K. Al-Soufi, T. Sennoga, A. Memon, M. Worku, and L. Alhems, "Contamination Level Monitoring Techniques for High-Voltage Insulators: A Review," *Energies (Basel)*, vol. 15, no. 20, p. 7656, Oct. 2022, doi: 10.3390/en15207656.
- [2] H. Rajini, A. Ballaji, S. Saahithi, M. Bharat, and P. Ashwini Kumari, "Comparative performance of insulating materials used in high voltage insulators," 2022, p. 040001. doi: 10.1063/5.0094121.
- [3] M. Ramesh, L. Cui, and R. S. Gorur, "Impact of superficial and internal defects on electric field of composite insulators," *International Journal of Electrical Power & Energy Systems*, vol. 106, pp. 327–334, Mar. 2019, doi: 10.1016/j.ijepes.2018.10.013.
- [4] M. A. Amini and A. R. Sedighi, "A new procedure for determination of insulators contamination in electrical distribution networks," *International Journal of Electrical Power & Energy Systems*, vol. 61, pp. 380–385, Oct. 2014, doi: 10.1016/j.ijepes.2014.03.034.
- [5] C. Volat, M. Jabbari, M. Farzaneh, and L. Duvillaret, "New method for in live-line detection of small defects in composite insulator based on electro-optic E-field sensor," *IEEE Transactions on Dielectrics and Electrical Insulation*, vol. 20, no. 1, pp. 194–201, Feb. 2013, doi: 10.1109/TDEI.2013.6451358.
- [6] L. Cui and M. Ramesh, "Prediction of flashover voltage using electric field measurement on clean and polluted insulators," *International Journal of Electrical Power & Energy Systems*, vol. 116, p. 105574, Mar. 2020, doi: 10.1016/j.ijepes.2019.105574.
- [7] G. Gaborit, J.-L. Coutaz, and L. Duvillaret, "Vectorial electric field measurement using isotropic electro-optic crystals," *Appl Phys Lett*, vol. 90, no. 24, Jun. 2007, doi: 10.1063/1.2748364.
- [8] S. S. Hegde, A. Zouaghi, G. Gaborit, C. Vollaie, and L. Duvillaret, "Pockels effect based electro-optic sensor for partial discharge measurement in medium and high voltage equipment," in *Conference on Electrical Insulation and Dielectric Phenomena*, IEEE, Oct. 2023.
- [9] S. S. Hegde, A. Zouaghi, G. Gaborit, C. Vollaie, and L. Duvillaret, "Characterization of Corona and Dielectric Barrier Discharge using Pockels Effect Based Electro-Optic Probe," in *2023 IEEE Industry Applications Society Annual Meeting (IAS)*, IEEE, Oct. 2023, pp. 1–5. doi: 10.1109/IAS54024.2023.10406958.
- [10] Y. Gaeremynck, G. Gaborit, L. Duvillaret, M. Ruaro, and F. Lecoche, "Two electric-field components measurement using a 2-port pigtailed electro-optic sensor," *Appl Phys Lett*, vol. 99, no. 14, Oct. 2011, doi: 10.1063/1.3646103.
- [11] M. Ramesh and R. S. Gorur, "Stretched grid finite difference method for computation of electric field in composite insulators with defects," *Electric Power Systems Research*, vol. 192, p. 106875, Mar. 2021, doi: 10.1016/j.epsr.2020.106875.