



**HAL**  
open science

## A novel dynamical model for diagnosis, prognosis and health-aware control of Lithium-ion batteries

John Jairo Martinez Molina, Monica Spinola Felix, Chetan Kulkarni, Marcos Orchard, Christophe Bérenguer

► **To cite this version:**

John Jairo Martinez Molina, Monica Spinola Felix, Chetan Kulkarni, Marcos Orchard, Christophe Bérenguer. A novel dynamical model for diagnosis, prognosis and health-aware control of Lithium-ion batteries. SAFEPROCESS 2024 - 12th IFAC Symposium on Fault Detection, Supervision and Safety for Technical Processes, IFAC, Jun 2024, Ferrara, Italy. pp.658-663, 10.1016/j.ifacol.2024.07.294 . hal-04689058

**HAL Id: hal-04689058**

**<https://hal.science/hal-04689058v1>**

Submitted on 19 Oct 2024

**HAL** is a multi-disciplinary open access archive for the deposit and dissemination of scientific research documents, whether they are published or not. The documents may come from teaching and research institutions in France or abroad, or from public or private research centers.

L'archive ouverte pluridisciplinaire **HAL**, est destinée au dépôt et à la diffusion de documents scientifiques de niveau recherche, publiés ou non, émanant des établissements d'enseignement et de recherche français ou étrangers, des laboratoires publics ou privés.



Distributed under a Creative Commons Attribution - NonCommercial - NoDerivatives 4.0 International License

# A novel dynamical model for diagnosis, prognosis and health-aware control of Lithium-ion batteries

John J. Martinez\* Mônica S. Félix\* Chetan Kulkarni\*\*  
Marcos Orchard\*\*\* Christophe Bérenguer\*

\* *Université Grenoble Alpes, CNRS, Grenoble INP, GIPSA-Lab, 38000  
Grenoble, France. (e-mail: name.surname@gipsa-lab.fr)*

\*\* *NASA Ames Research Center (KBR, Inc), Moffett Field, CA 94043,  
USA, (e-mail: chetan.s.kulkarni@nasa.gov)*

\*\*\* *CASE - Univ. of Chile, Santiago, Chile, (e-mail:  
morchard@u.uchile.cl)*

---

**Abstract:** In this work it is proposed a novel dynamical model of the Lithium-ion batteries intended for diagnosis, prognosis and health-aware control. The proposed model is a particular version of an equivalent electrical circuit and a thermal model. Here, we illustrate how a more accurate model of both: the open-circuit voltage and the internal resistance can be used for improving the estimation of the battery aging. The modeling problem considers that a new battery can be considered as a reference battery with nominal behavior, and the deteriorated one has the same mathematical structure with a multiplicative degradation parameter, considered here to be an input of the system. The battery deterioration is considered to simultaneously affect both the capacity of the battery and the value of the internal resistance. The problem is solved by finding the system input (i.e. the degradation parameter) as the solution of a feedback control problem which minimizes the prediction error concerning the terminal voltage. Experimental data is used to illustrate the proposed battery model and its corresponding degradation parameter estimation. The results also include obtained estimations on temperatures and State of Charge for different battery aging scenarios.

*Keywords:* Health monitoring and diagnosis, modeling and simulation of batteries, Robust estimation, energy storage systems, Remaining Useful lifetime prediction, health-aware control.

---

## 1. INTRODUCTION

Lithium-ion batteries play a central role in modern technology, powering a wide range of devices from portable gadgets to electric vehicles. Their exceptional properties, such as high energy density, low weight and long lifespan, have brought about a important change in energy storage and use. However, over time, lithium-ion batteries can degrade, resulting in reduced capacity and efficiency, which significantly affects their overall performance and lifespan (Pelletier et al. (2017)). This degradation has a significant impact on processes that rely on this technology. For example, in electric vehicles, the degradation of lithium-ion batteries results in a reduced trajectory range, primarily due to the loss of capacity, which limits the autonomy of the vehicle (Taefi et al. (2016)) and increases the cost contribution of the battery (Nykqvist and Nilsson (2015)). Such issue prompted the investigation of the aging process in lithium-ion batteries.

Specifically, during cycling and storage, lithium-ion batteries can be subject to a combination of mechanical and chemical processes that lead to battery aging, including lithium metal plating, loss of active materials, loss of cyclable lithium, and thickening of the passive film on the carbon anode due to electrolyte reduction. According to

Barré et al. (2013), phenomena such as loss of cyclable lithium and loss of active material lead to a decrease in energy storage capacity, reducing the battery's ability to hold a charge and requiring more frequent cycling. Also according to the authors, the thickening of the passive film increases the impedance, indicating an increase in the internal resistance of the battery and a reduction in the maximum available power. Both effects together contribute to the reduction in battery performance, as seen in Figure 1.

Despite the considerable interest in enhancing battery lifespan, modeling and controlling such aging process poses a significant challenge. As a result, various modeling approaches for different applications have been explored in prior research, including physical and empirical approaches, which are extensively reviewed in (Pelletier et al. (2017)), (Rosewater et al. (2019)) and (Collath et al. (2022)). Each approach offers a number of advantages and disadvantages. While physical models provide higher accuracy (see for instance Bole et al. (2014)), they are usually complex hampering the integration with embedded systems. On the other hand, empirical models prioritize simplicity but may lack the adaptability needed to be included in different applications and struggle to isolate stress factors due to the significant interconnec-

tions between degradation variables and operating conditions, especially the increased temperature caused by charge/discharge currents. In both types of approaches there exists a notable gap in models that integrate degradation and battery charging/discharging behavior. Particularly, aging is often primarily associated with capacity fade, while the combined effects of reduced capacity and increased resistance are frequently overlooked. Therefore, additional research is necessary to enhance the modeling of lithium-ion batteries, incorporating the aging process with a specific emphasis on health-aware control, focusing on simplicity, adaptability, and addressing the correlation between resistance and capacity variations.

In this paper we are interesting in proposing a dynamical model which includes a degradation index allowing to absorb all the possible sources of degradation in just one parameter. This simplification is useful for focusing in the estimation of the trend of such degradation index, as it will be illustrated in this paper by using experimental data that was firstly presented in Daigle and Kulkarni (2016).

The proposed model is intended for simulation, analysis, diagnosis or even prognosis and health-aware control of Lithium-ion batteries. The latter by using for instance the techniques proposed in Spinola-Felix et al. (2023).

Reliable estimations of SoC in presence of battery deterioration is still an open problem. Previous works, as Turner (2016) are mostly intended for estimating this SoC by using the Extended Kalman Filter approach without considering the effect of the deterioration on the estimations. In this paper, we will show how a simple model and a Proportional-Integral (PI) estimator could be used for simultaneously estimating a deterioration index, the SoC and the cell temperature based on available electrical measurements (terminal voltage and current). The main assumption concerns the fact that the open-circuit voltage and the "reference" internal resistance (both function of the SoC), are *a priori* known.

This paper is organized as follows: Firstly, we present the novel dynamical battery model which includes the mentioned deterioration parameter (or index), Then we illustrate a very simple method for real-time estimation of such deterioration index. Finally, it is presented preliminary results, concerning degradation estimation, State of Charge (SoC) estimation and battery-cell temperature estimation, based on the proposed model and using experimental data provided by NASA Ames Research Center. Conclusions and future work are presented in the last Section.

## 2. NOVEL BATTERY CELL MODEL WITH A DEGRADATION PARAMETER

### 2.1 Modeling assumptions

In this paper we consider that only the terminal voltage, denoted  $V_t$ , and the electrical current, denoted  $I$ , can be measured at every time instant.

In addition, it is considered that the terminal voltage trajectories are function of the battery aging but both the  $V_{oc}$  and the nominal internal resistance  $R_n$  remain invariant with respect to the aging, and they only depends (non-linearly) on the SoC. i.e.

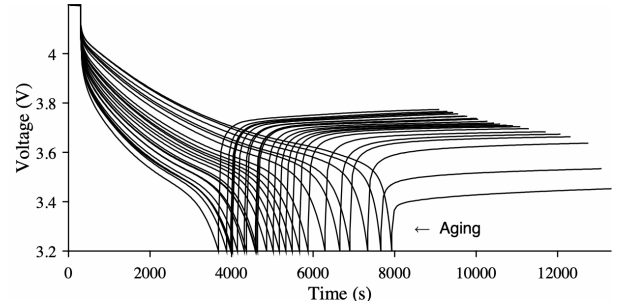

Fig. 1. Terminal voltage during discharging ( $I = 1A$ ) for different aging situations. This Figure is taken from Daigle and Kulkarni (2016).

$$V_{oc} := V_{oc}(SoC), \quad R_n := R_n(SoC) \quad (1)$$

Thus, we consider that aging is due to a degradation parameter  $\gamma \geq 1$ , such that:

$$C = \frac{C_n}{\gamma}, \quad R = R_n(SoC)\gamma \quad (2)$$

i.e. the battery capacity  $C$ , in Ah, decreases with age and the internal resistance  $R$  increases with the age (degradation) of the battery. Because the nominal resistance  $R_n$  only depends on the SoC, we can assume that the degradation parameter absorbs increments on the internal resistance due to increments on the battery aging (for a given cell temperature). Actually, the internal resistance value also depends on the Discharging or Charging situation. In this paper only Discharging situations are considered and the study is focused on scenarios where battery cell and room temperatures remain around a given "reference" temperature. See for instance Lebkowski (2017), where it is presented the dependence of internal resistance versus temperature, in particular on Lithium-ion batteries.

Thus, the **main assumptions** can be summarized as follows (for a given reference temperature):

- The internal resistance is not constant during discharging and charging. It increases as SoC decreases.
- The open-circuit voltage only depends on the SoC.
- Increase of internal resistance and decrease of capacity are well correlated. They are images of the same degradation phenomena.
- The degradation parameter  $\gamma$  (in particular its very low-frequency component) mainly absorbs the aging of the battery.

### 2.2 Electrical circuit model

Consider a **degradation parameter**  $\gamma(k) \geq 1$  ( $\gamma = 1$  means that the battery cell is a new one as a given reference battery).

Thus, the dynamics of the **State of Charge** (SoC, that we will denoted  $z$ , in the sequel), for a battery capacity under degradation, can be modeled as:

$$z(k+1) = z(k) - T_s \frac{I(k)}{(3600 \cdot C_n)} 100 \cdot \gamma(k) \quad (3)$$

where  $C_n$  stands for the nominal value of capacity, whereas the **terminal voltage** could be:

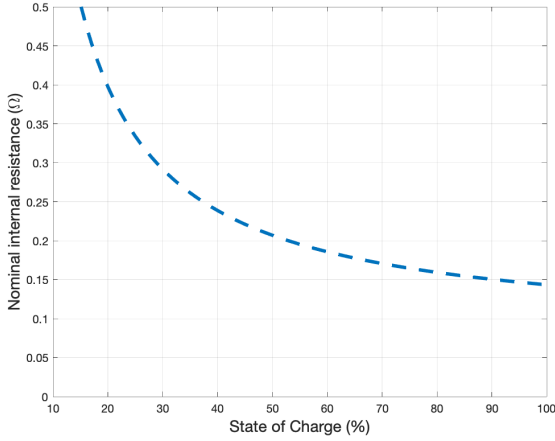

Fig. 2. Example of a nominal behavior of the internal resistance (for a **reference** new battery) with respect to the State of Charge, during discharging cycles.

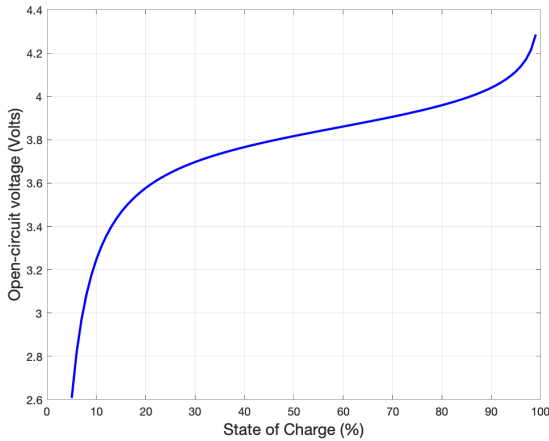

Fig. 3. Example of the open-circuit voltage (for a **reference** new battery) with respect to the State of Charge, during discharging cycles.

$$V_t(k+1) = aV_t(k) + (1-a)E(k) \quad (4)$$

with

$$E(k) = V_{oc}(z(k)) - R_n(z(k)) \cdot I(k) \cdot \gamma(k) \quad (5)$$

with  $V_{oc}$  and  $R_n$  functions of the current SoC, i.e.  $z(k)$ . The parameter  $a$  is intended to model the dynamical behavior of a battery voltage.

Remark that the degradation parameter  $\gamma(k)$  can be considered as a system input affecting the Linear Parameter Varying model (3) - (5), by considering  $I(k)$  as a scheduling parameter. Observers design for discrete-time LPV systems can be achieved as it is proposed in Martinez et al. (2018); Halimi et al. (2013).

Therefore, accurate models of nominal  $V_{oc}(z(k))$  and  $R_n(z(k))$  (i.e. for a "reference" new battery), could improve the quality of the estimations of the input  $\gamma(k)$ , as it will be illustrated more latter.

Here for instance we model  $V_{oc}(z(k))$ , as follows (similar to the models presented in Plett (2004)):

$$V_{oc}(z(k)) := E_o - K_1 \ln(100 - z(k)) - \frac{K_2}{z(k)} \quad (6)$$

for constant  $E_o$ ,  $K_1$  and  $K_2$ , whereas the internal resistance is modeled as

$$R_n(z(k)) = R_1 + \frac{R_2}{z(k)} \quad (7)$$

for constant  $R_1$  and  $R_2$ , whose values can be different according to the situation : for Charging or Discharging cycles. See for instance (Pelletier et al. (2017)) for more complex Charging or Discharging internal resistance models.

Figure 2 illustrates the considered nominal internal resistance  $R_n(z(k))$  with respect the SoC  $z(k)$  in percentage. Figure 3 shows the considered open-circuit voltage for a reference battery during discharging cycles and for constant nominal ambient temperature.

### 2.3 Thermal model

The proposed model can be extended by including a dynamical thermal model to make use of possible measurements of the cell temperatures. If we assume that internal resistance increases during the battery deterioration, it will be also affect temperature since the Joule losses are function of such resistance. Thus, we suppose that the dynamics of the cell temperature obeys:

$$T(k+1) = c_0T(k) + (1-c_0)(T_{Joule}(k) + T_{amb}(k)) \quad (8)$$

with

$$T_{Joule}(k) = c_1R_n(z(k))I(k)^2\gamma(k) \quad (9)$$

That is, the temperature is an image of the dissipated energy within the cell which depends on the degradation parameter  $\gamma(k)$ . Here  $T$  is the temperature within the cell and  $T_{amb}$  the ambient temperature including all possible heat contributions of the neighborhood cells. Parameter  $c_0$  and  $c_1$  are function of cell heat capacity and convection thermal resistance but they can be estimated by data-driven techniques, for a given **reference** new battery. The thermal model (8)-(9) includes the main sources of heat in batteries, as it is stated in Rao and Newman (1997).

## 3. ESTIMATING THE DEGRADATION PARAMETER

The proposed model can be used for performing simulations under different levels of deterioration, and by consequence, it could be useful for prognosis and health-aware control. Here, we will illustrate the use of this model for real-time estimation of the level of deterioration  $\gamma$  of a given Lithium-ion battery, under the assumptions that both electrical current and terminal voltage are available at every time instant.

We can solve the problem of estimating  $\gamma(k)$  of a given battery cell, as the problem of finding  $\hat{\gamma}(k)$  such that the prediction error  $e(k) := V_t(k) - \hat{V}_t(k)$  (or alternatively  $e(k) := T(k) - \hat{T}_t(k)$ ) is minimized. For instance, by using the dynamics:

$$\hat{\gamma}(k+1) = \hat{\gamma}(k) + \mathbf{K}_i \cdot e(k) \quad (10)$$

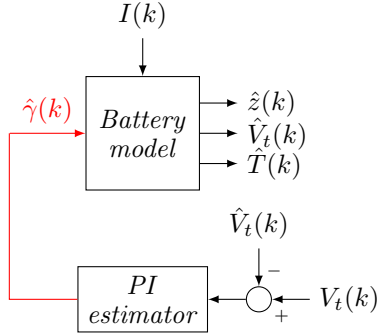

Fig. 4. Proportional-Integral control feedback scheme for estimating the deterioration index  $\gamma(k)$ . The battery model of a healthy new battery is assumed to be known and both: the electrical current and the terminal voltage are available data.

with a suitable (probably time-varying) gain  $\mathbf{K}_i$ , which is in fact a Proportional-Integral-type estimator as it is illustrated in Figure 4. Here, it minimizes the prediction error  $e(k) := V_t(k) - \hat{V}_t(k)$  and focus on the estimation of one parameter, i.e. only on the estimation of  $\gamma(k)$ . The battery model of a healthy new battery (i.e. when  $\gamma(k) = 1$ ) is assumed to be known.

The estimator uses the battery model (3)-(9).

Remark that the vector  $[z, V_t, T]^T$ , can be estimated by using the proposed battery model and by considering the measured output  $y(k) = V_t(k)$  and the scheduling parameter  $\rho(k) = I(k)$  as it is the case for Linear Parameter Varying (LPV) systems, see again Figure 4. Thus, the choice of the integral gain  $\mathbf{K}_i$  can be obtained by using Robust Control techniques, assuring stability for any value of  $I(k)$  in a given possible interval of values, for instance  $0 \leq I(k) \leq 3A$  (for discharging scenarios).

Here we suppose that the **reference parameters of a new battery** are known, as well as the initial conditions. For instance  $\hat{z}(0) = 100\%$ ,  $\hat{V}_t(0) = 4.2V$  and  $\hat{T}(0) = T_{amb}(0)$  in  $^{\circ}C$ . Here the PI estimator is initialised with  $\hat{\gamma}(0) = 1$  for most of the scenarios.

Since the deterioration parameter  $\gamma(k)$  is estimated at every second, here the SoC can be calculated by using "Coulomb counting", in equation (3) i.e. by measuring the battery current and integrating it in time. Thus, the estimation of SoC must be re-calibrated on a regular basis, such as by resetting the SoC to 100% when a charger determines that the battery is fully charged ( $V_t$  around 4.2V. and  $I = 0A$ ).

#### 4. EXPERIMENTAL RESULTS

Here we present preliminary results by solving a voltage-based fitting problem. By considering experimental data used in Daigle and Kulkarni (2016), it was possible to find the values of the deterioration parameter  $\gamma$  such that the modeled terminal voltage fits the measured one.

Table 1 presents the used model parameters, corresponding to a commercial cell LGDAS31865, 2200 mAh, 3.6V. Remark that a value of  $C_n = 2.64Ah$  is used here. This value has been obtained in such a way that the achieved

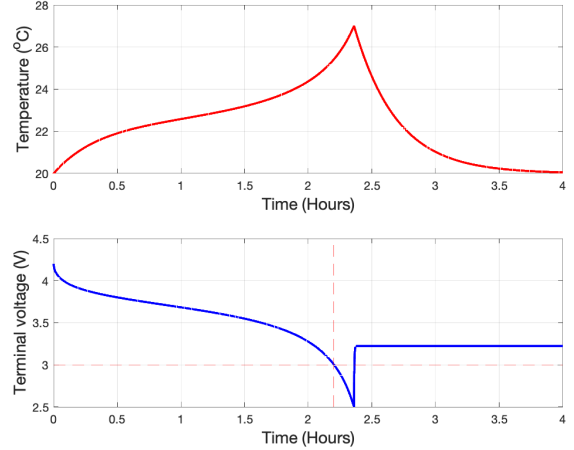

Fig. 5. Model simulation of a new battery for constant current discharge ( $I = 1A$ ) and 2.5V voltage cutoff.

Parameter	Symbol	Value	Units
Nominal cell capacity	$C_n$	2.64	Ah
Internal resistance term 1	$R_1$	0.08	Ohms
Internal resistance term 2	$R_2$	6.3497	-
Open-circuit voltage parameter 1	$K_1$	0.1038	-
Open-circuit voltage parameter 2	$K_2$	6.3497	-
Open-circuit voltage parameter 3	$E_0$	4.35	Volts
Voltage filtering parameter	$a$	0.9048	-
Temperature filtering parameter	$c_0$	0.9992	-
Thermal Joule-term parameter	$c_1$	16	$^{\circ}C/W$
Sampling time	$T_s$	1.00	s

Table 1. Used parameters for the battery-cell model.

capacity will be 2.2Ah at 3.0V voltage cutoff, for a new battery, as commercially announced for this kind of batteries.

Figure 5 shows a simulation for illustrating the achieved trajectories for temperature and for terminal voltage of a new battery if 2.5V voltage cutoff is used.

We have implemented the PI estimator proposed in Section 3, for an integral gain  $\mathbf{K}_i = -20 \cdot \text{sign}(I)$ . This value has been obtained in such a way that stability of the estimation error is assured. This value can be chosen in a more optimal way, and this will be the object of a future work.

Figures 6 and 7 illustrate the obtained model fit and their corresponding estimated degradation parameter (or level) and estimated SoC.

Figures 8 and 10 illustrate the measured temperatures compared to those estimated ones by using estimations of the deterioration parameter  $\gamma$  as proposed in Section 3. The scenario concerns the temperature evolution for Pulsed Load Charging and Discharging Cycles, for a new and old cells. The ambient temperature is considered to be constant in the model case curve which can explain the offsets values since the ambient temperature can vary around its expected equilibrium in about  $\pm 1^{\circ}C$ .

These results suggest that the proposed model is quite accurate to estimate the degradation parameter  $\gamma$ . See Figures 9 and 11. A comparison of obtained estimated

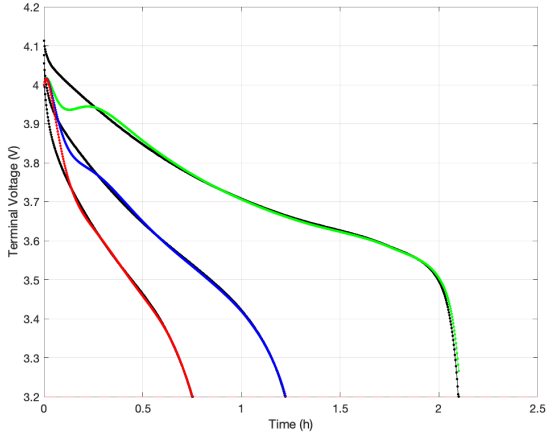

Fig. 6. Model fitting of terminal voltage during discharging ( $I = 1A$ ) for three different aging cases.

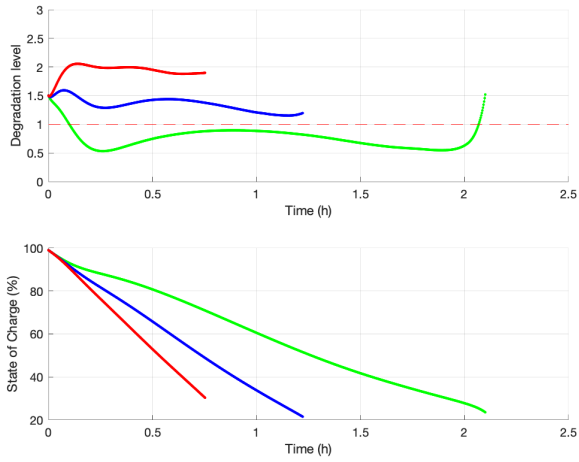

Fig. 7. Estimated degradation parameter  $\gamma$  and SoC during discharging ( $I = 1A$ ) for three different aging cases.

SoC, for new and old batteries, are presented in Figure 12. Because the considered SoC is the nominal one (i.e. we do not use the *apparent* one), the battery cut-off voltage (3.2V) is achieved for SoC bigger than 20%, and by consequence, the nominal internal resistance never achieves values bigger than 0.4 ohms, as we can see in Figure 2.

## 5. CONCLUSIONS AND FUTURE WORK

In this paper, we have presented a new dynamical model for Lithium-ion batteries that explicitly includes a parameter that models the aging of the battery. The obtained experimental results illustrate the interest of a such model. The proposed model is described by an equivalent electrical circuit, the State of Charge dynamics by using a Coulomb counting equation, and a thermal dynamics. All these sub-models are affected by an input that increases with the aging of the battery. Thus, the model could be used for direct estimation of this input by using available measurements. Here, a PI-based controller is used for estimation a such input by considering the availability of the terminal voltage, the electrical current and the initial

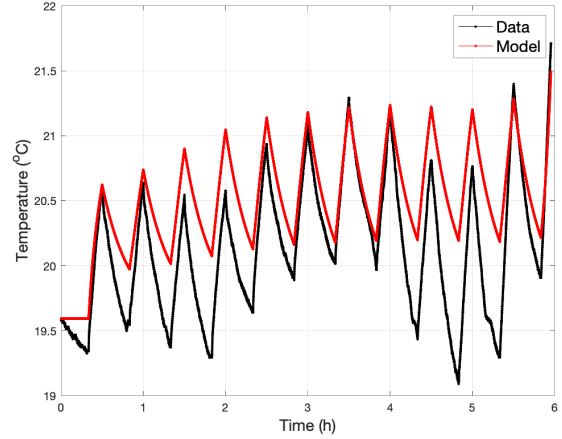

Fig. 8. Cell temperature evolution, during a pulsed current scenario, for a new cell. The ambient temperature is considered to be constant in the model case curve.

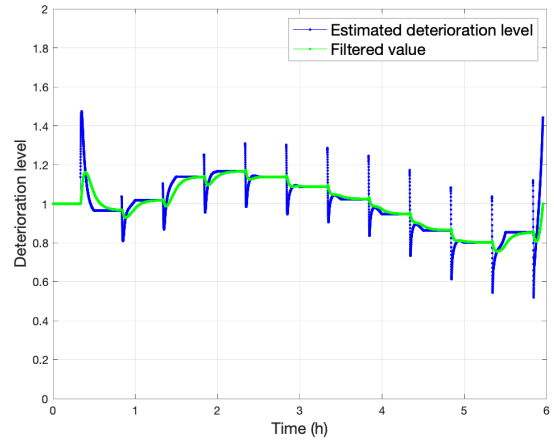

Fig. 9. Estimated deterioration level, during a pulsed current scenario, for a new cell.

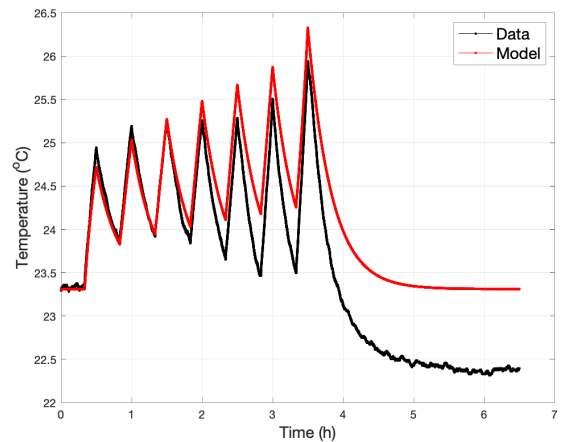

Fig. 10. Cell temperature evolution, during a pulsed current scenario, for an old cell. The ambient temperature is considered to be constant in the model case curve.



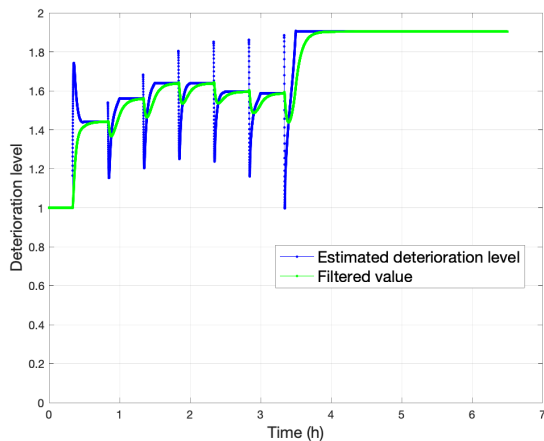

Fig. 11. Estimated deterioration level, during a pulsed current scenario, for an old cell.

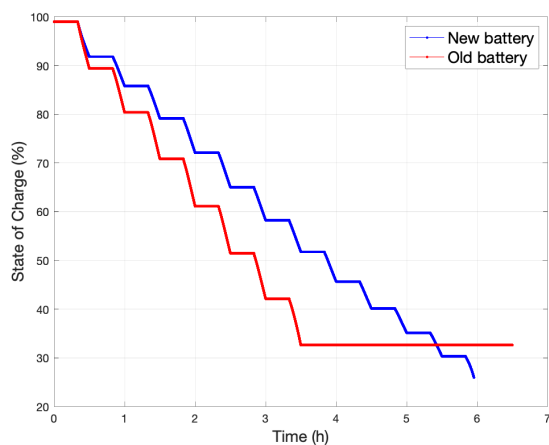

Fig. 12. Estimated SoC during a pulsed current scenario, for a new and an old cell.

conditions of State of Charge. The approach could be extended by including possible available measurements of the battery cell temperature. The proposed model can also be used for simulating a battery under particular conditions of aging, performing prognosis tasks and for building control algorithms for health management or useful lifetime control of such systems. These points will be the subject of future work.

## REFERENCES

- Barré, A., Deguilhem, B., Grolleau, S., Gérard, M., Suard, F., and Riu, D. (2013). A review on lithium-ion battery ageing mechanisms and estimations for automotive applications. *Journal of Power Sources*, 241, 680–689.
- Bole, B., Kulkarni, C.S., and Daigle, M.. (2014). Adaptation of an electrochemistry-based li-ion battery model to account for deterioration observed under randomized use. In *Annual Conference of the PHM Society*, volume 6.
- Collath, N., Tepe, B., Englberger, S., Jossen, A., and Hesse, H. (2022). Aging aware operation of lithium-ion battery energy storage systems: A review. *Journal of Energy Storage*, 55, 105634.
- Daigle, M. and Kulkarni, C.S. (2016). *End-of-discharge and End-of-life Prediction in Lithium-ion Batteries with Electrochemistry-based Aging Models*. doi: 10.2514/6.2016-2132.
- Halimi, M., Millerioux, G., and Daafouz, J. (2013). Polytopic Observers for LPV Discrete-Time Systems. In O. Sename, P. Gaspar, and J. Bokor (eds.), *Robust Control and Linear Parameter Varying Approaches*, volume 437, 97–124. Springer Berlin Heidelberg, Berlin, Heidelberg. doi:10.1007/978-3-642-36110-4\_5. Series Title: Lecture Notes in Control and Information Sciences.
- Lebkowski, A. (2017). Temperature, overcharge and short-circuit studies of batteries used in electric vehicles. *Przeegląd Elektrotechniczny*, 1, 69–75. doi: 10.15199/48.2017.05.13.
- Martinez, J.J., Loukkas, N., and Meslem, N. (2018). H-infinity set-membership observer design for discrete-time LPV systems. *International Journal of Control*, 1–12. doi:10.1080/00207179.2018.1554910.
- Nykvist, B. and Nilsson, M. (2015). Rapidly falling costs of battery packs for electric vehicles. *Nature climate change*, 5(4), 329–332.
- Pelletier, S., Jabali, O., Laporte, G., and Veneroni, M. (2017). Battery degradation and behaviour for electric vehicles: Review and numerical analyses of several models. *Transportation Research Part B: Methodological*, 103, 158–187.
- Plett, G.L. (2004). Extended kalman filtering for battery management systems of lipb-based hev battery packs: Part 2. modeling and identification. *Journal of Power Sources*, 134(2), 262–276. doi: https://doi.org/10.1016/j.jpowsour.2004.02.032.
- Rao, L. and Newman, J. (1997). Heat-generation rate and general energy balance for insertion battery systems. *Journal of the Electrochemical Society*, 144(8). doi: 10.1149/1.1837884.
- Rosewater, D.M., Copp, D.A., Nguyen, T.A., Byrne, R.H., and Santoso, S. (2019). Battery energy storage models for optimal control. *IEEE Access*, 7, 178357–178391. doi:10.1109/ACCESS.2019.2957698.
- Spinola-Felix, M., Martinez, J.J., and Berenguer, C. (2023). A state-space approach for remaining useful life control. In *IFAC World Congress, Yokohama, Japan*.
- Taefi, T.T., Kreutzfeldt, J., Held, T., Konings, R., Kotter, R., Lilley, S., Baster, H., Green, N., Laugesen, M.S., Jacobsson, S., et al. (2016). Comparative analysis of european examples of freight electric vehicles schemes—a systematic case study approach with examples from denmark, germany, the netherlands, sweden and the uk. In *Dynamics in Logistics: Proceedings of the 4th International Conference LDIC, 2014 Bremen, Germany*, 495–504. Springer.
- Turner, J. (2016). *3. Simplified Extended Kalman Filter Observer for SOC Estimation of Commercial Power-Oriented LFP Lithium Battery Cells (2013-01-1544)*, 19–28.