

# Radar ADAS: Virtual modeling of targets

*Speaker:* Vanessa PALMIER

*Architect engineer in Calculation and Optimisation*

**IRT SystemX – France**

*Team members:* V. Palmier - A. Rizduan – A. Serval – F. Faucher – S. Prabakaran - V. Faquet

### ■ IRT SystemX

Founded in 2012 under the « Investing for the future », IRT SystemX positions itself as an accelerator for digital transformation of industry, services and territories.

2 fundamental aspects:

- Brings talents together
- Pooling of skills and platforms

### ■ CVH Project

The [CVH project](#) (**Tool-based chain for the validation and certification of the connected automated vehicle**) led by IRT SystemX, which is an extension of the [3SA project](#), aims to accelerate the methodological and tool-based work for the validation of the connected automated vehicle in compliance with regulatory and normative rules.

This presentation is about part of the work carried out within the sensors (Camera, LiDAR, RADAR) modelling task of the CVH project. More specifically, it focuses on the problem of modelling Radar in a constrained synthetic environment.

- 1. Methodology**
- 2. Targets characterization (real part)**
- 3. Target Modeling (virtual part)**
- 4. Conclusion & Next Steps**

- 1. Methodology**
2. Targets characterization (real part)
3. Target Modeling (virtual part)
4. Conclusion & Next Steps

### ■ Vocation

- Develop sensor model and disturbance models specific to the RADAR for the simulation platform.
- 3 issues for a “realistic” simulation environment :
  - Creating a sensor model
  - Creating virtual target models faithful to real ones [1]
  - Creating disturbance models faithful to real sensor responses [2]



The need for real-life measurements, to create a realistic virtual environment, such as for the mesh size of 3D models, or to highlight phenomena such as multipaths, among others.

### ■ Steps:

1. Real characterization with IMT (Mines Telecom Institute) Atlantique and design of virtual sensor and targets
2. Real rides with UTAC and Scenarios design in synthetic environment
3. Development, validation and integration of disturbances models in the simulation platform of the project

[1] Backscattering Behavior of Vulnerable Road Users Based on High-Resolution RCS Measurements. Abadpour, S. and al, *IEEE Transactions on Microwave Theory and Techniques*, Vol 70 Issue 4 March 2022

[2] Permittivity Determination Method for Multilayer Automotive Coatings for Radar Application at 77 GHz, Winter, C and al., *IEEE Transactions on Microwave Theory and Techniques*, COL 70 NO. 4 april 2022

## Methodology : Focus on the large targets modeling part

Real channel
Reference system and ADAS radar characterization and calibration [3]
<b>Characterization of targets</b> <ul style="list-style-type: none"> <li>➤ Via reference system</li> <li>➤ Via radar</li> <li>➤ Via literature data when available or analytic formula (for canonical shapes)</li> </ul>
<b>Evaluation of results - determination of biases</b> <ul style="list-style-type: none"> <li>➤ Analytical results vs. reference bench</li> <li>➤ Analytical results vs RADAR</li> <li>➤ Reference bench vs RADAR</li> </ul>

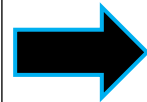

Virtual channel (Simulation)
<b>Virtual grounds and targets modeling</b> : 3d modeling + mesh + addition of physical characteristics of materials [3]
<b>Evaluation and accuracy of simulation tools [3]</b> <ul style="list-style-type: none"> <li>➤ SCANer s. and SE-WB simulations of RCS of canonical targets under ideal conditions</li> <li>➤ Comparison of results (analytical, bench, simulations)</li> </ul>
<b>Creation of virtual sensor for evaluation of targets models:</b> <ul style="list-style-type: none"> <li>➤ ideal isotropic sensor</li> <li>➤ virtual reference system model</li> </ul>
<b>Evaluate the accuracy of models (targets, sensors)</b> <ul style="list-style-type: none"> <li>➤ Comparison of software output with analytical values (canonical forms)</li> <li>➤ Comparison of software outputs with experimental values</li> </ul>
<b>Refining 3D models and sensor models if necessary</b>
<b>Validations of the models (targets and sensors)</b>

[3] virtual modeling of a radar, V.J. PALMIER and al., SIA vision 2022

1. Methodology
- 2. Targets characterization (real part)**
3. Target Modeling (virtual part)
4. Conclusion & Next Steps

## Targets characterization : *some targets*

### ■ Canonical shapes



Inox 304 sphere  
Ø = 60 mm

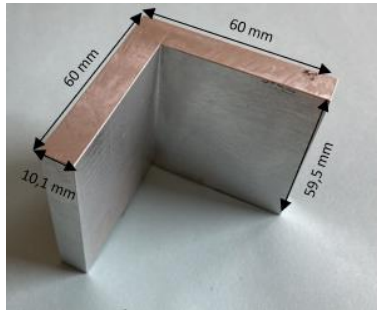

Aluminium dihedron

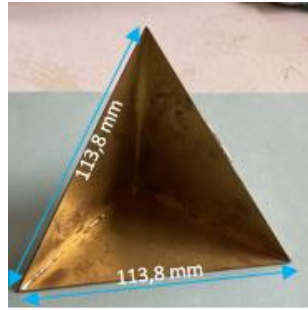

brass trihedron

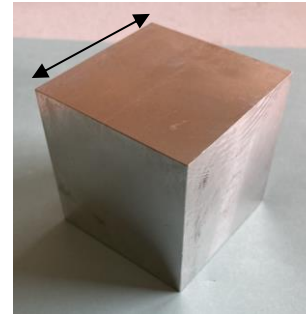

aluminum cube c = 59,5 mm



Inox 304 sphere  
Ø = 40 mm

etc.

### ■ Non canonical shapes and big targets

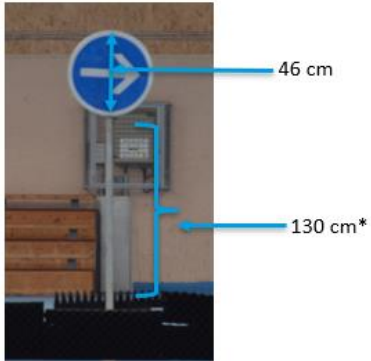

\*Norme AB4 respectée car minimum à 1m du sol.



RENAULT Zoe

Ducati Multi Strada 950



Ø=55mm  
h=120mm  
c=87mm  
Ø=15mm  
h=c+Ø=115mm  
L=66mm



## Targets characterization : *Equations of interest*

### ■ Far field

- $R = [\text{Cible-radar}] \geq D^2/\lambda \quad [\text{m}^2] \quad [1]$

*D = the largest dimension of the target and  $\lambda$  = the wavelength*

### ■ Liaison assessment:

- $P_{RX} = P_{TX} * G_{TX} * G_{RX} * \frac{\lambda^2}{(4\pi)^3 * R^4} \quad [\text{W}] \quad [2]$

*P<sub>RX</sub> = Received power, P<sub>TX</sub> = Emitted power, G<sub>TX</sub> = Transmitted Gain in transmission, G<sub>RX</sub> = Gain in reception*

### ■ RCS (*Radar Cross Section*) équation

- $\sigma = \frac{(4\pi)^3 R^4}{G_{TX} G_{RX} \lambda^2} \frac{P_{RX}}{P_{TX}} \quad [\text{m}^2] \quad [3]$

- Reference System

<b>Bi-static</b>	1 TX et 1 Rx identical
<b>Antenna Type</b>	Horn antenna
<b>Carrier Frequency</b>	79 GHz
<b>BW</b>	78-80 GHz
<b>Measurement chain noise</b>	~-20dBm
<b>Frequential step</b>	35 MHz
<b>Range resolution</b>	4,3 mm
<b>Angular pitch</b>	1,22 °

Reference system configuration

## Targets characterization : *Measurement Tools*

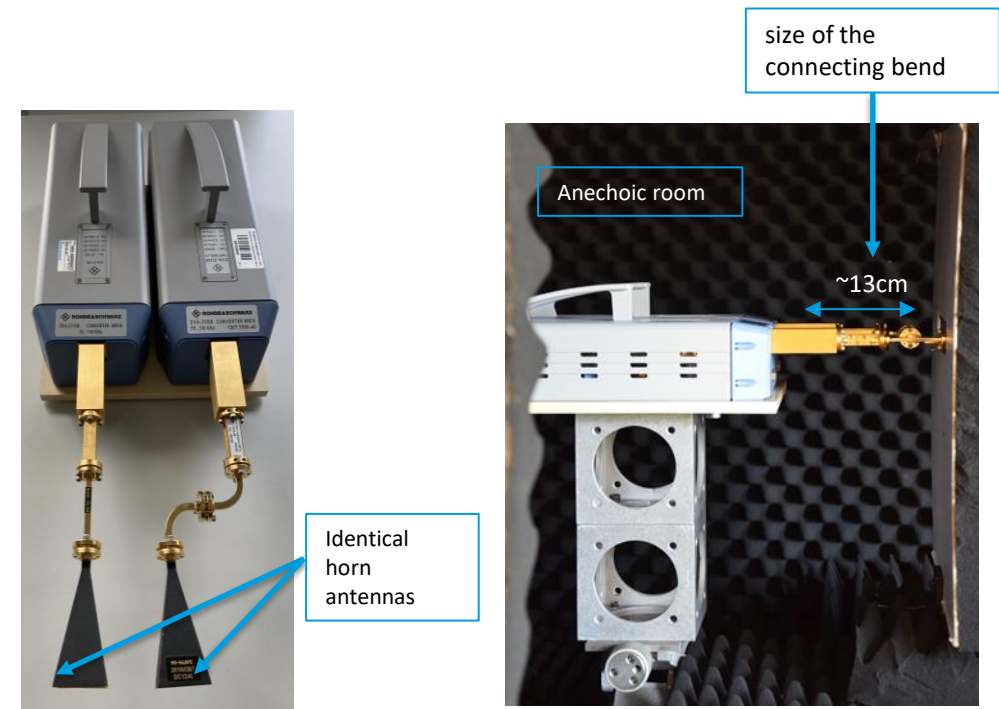

Reference system bi-static antenna system  
Left ) top view with horn antennas  
Right) view in the anechoic room

## Targets characterization : *Measurement Tools*

- RADAR ADAS

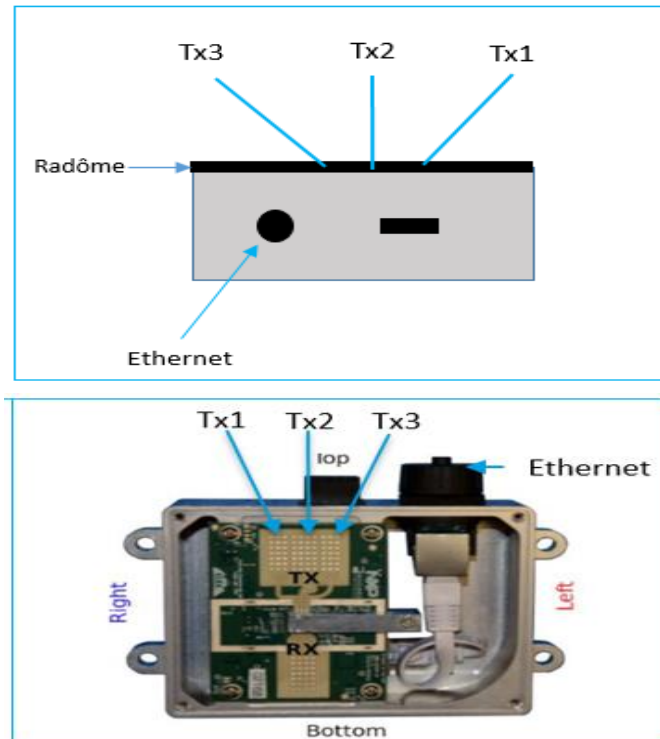

*Tx and Rx layout front view*

<b>MIMO</b>	<b>3 TX + 4 identical Rx</b>
<b>Antenna Type</b>	Patch antenna network
<b>Carrier Frequency</b>	79 GHz
<b>BW</b>	78-80 GHz
<b>Phi</b>	0°
<b>Theta</b>	0°
<b>Activated Tx</b>	The 3 TX
<b>Maximal range detection</b>	19,13m
<b>Range resolution</b>	75 mm
<b>Angular pitch</b>	3.79 °

*RADAR configuration*

## Targets characterization : *Experimental Protocol*

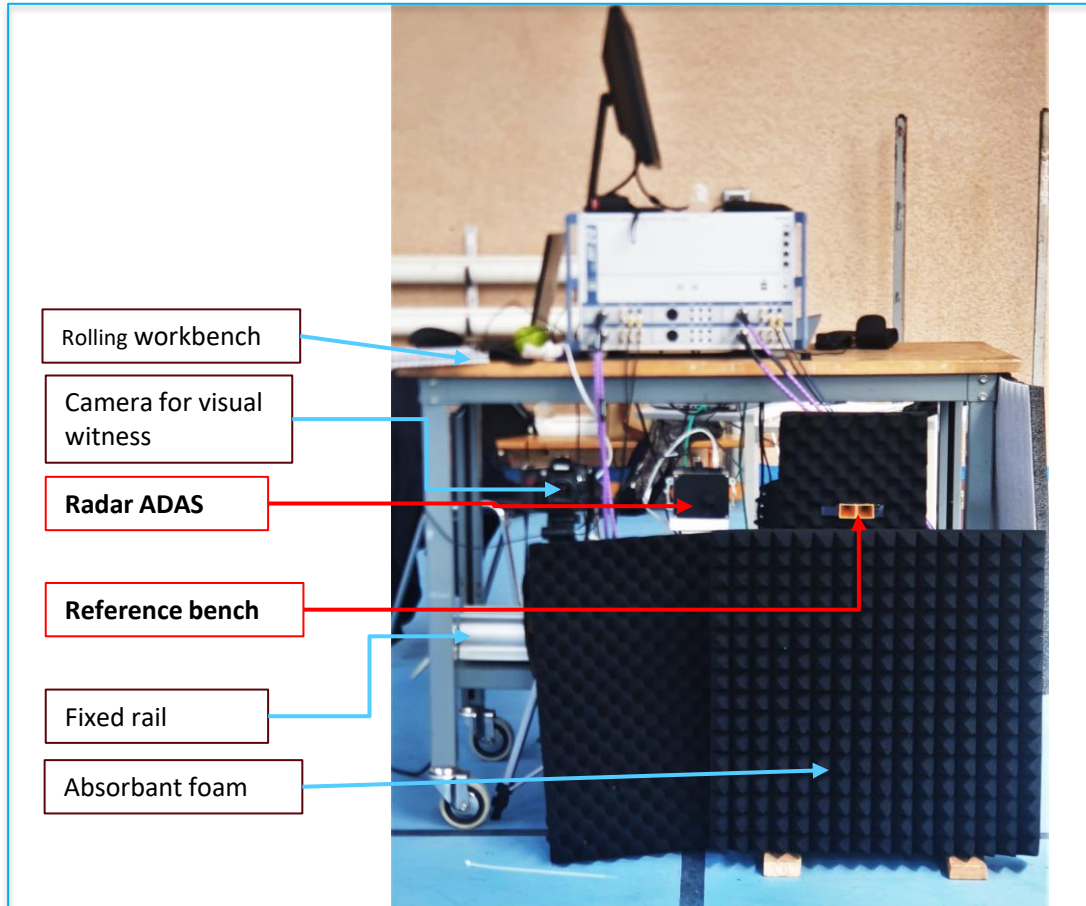

Measurement station

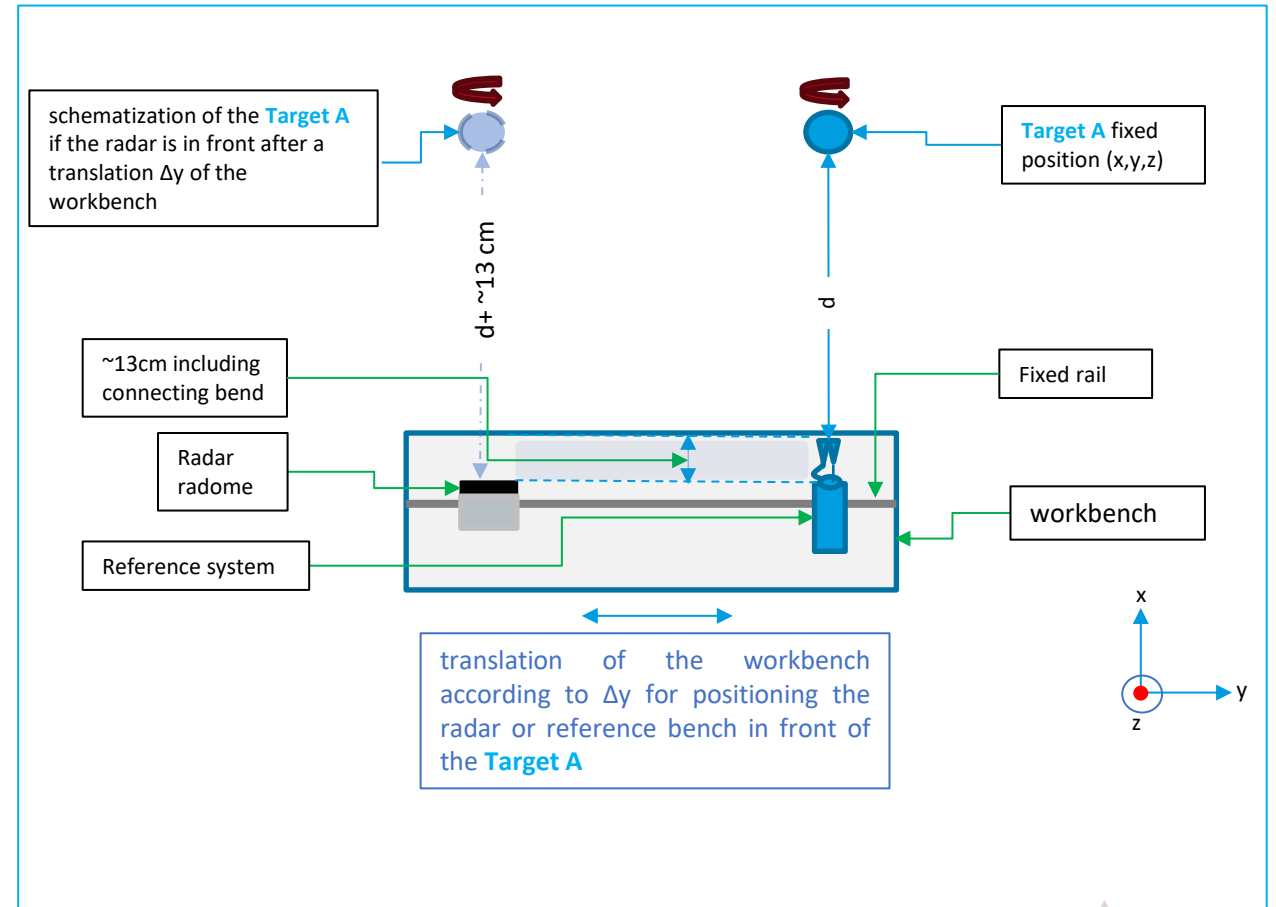

Experimental protocol

## Experimental measurement of a target: Renault Zoe

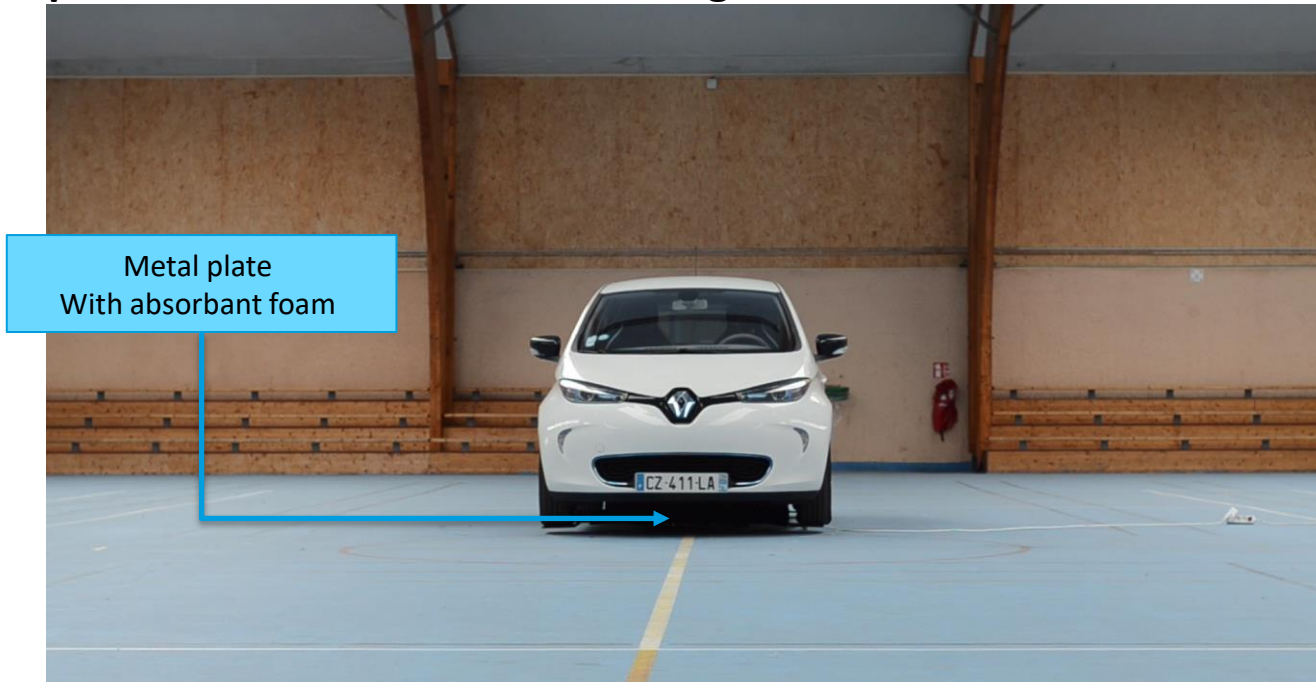

Metal plate  
With absorbant foam

Zoe power received measurements power received in controlled environment.  
 360° rotation.  
 Distance 18,5m  
 Fc=79GHz pour banc IMT et radar  
 BW=2GHz pour banc IMT et radar

## Targets characterization : *Measurement Example*

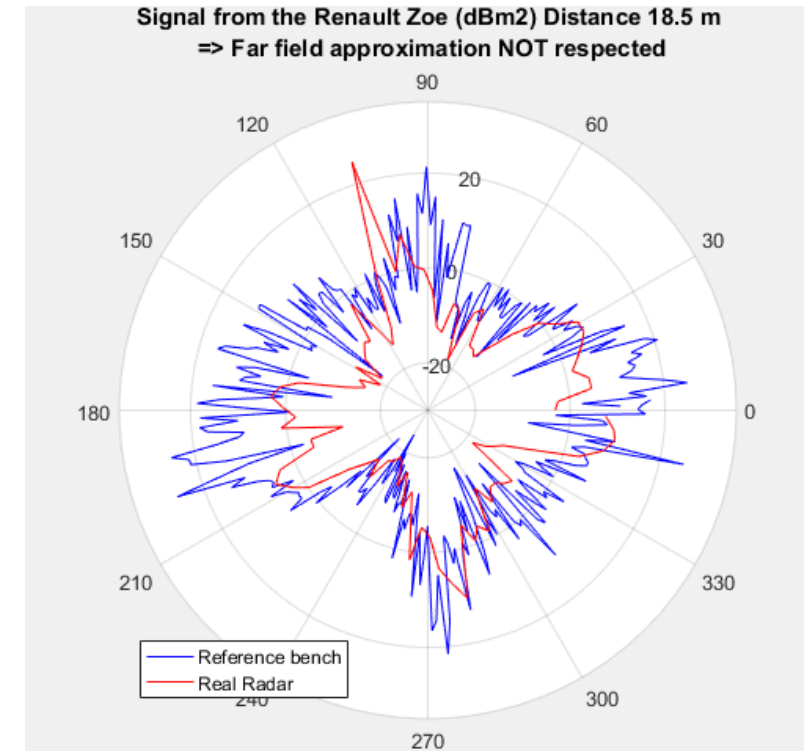

	RCS max (dBm2)	RCS mean (dBm2)
Reference system	25,79	1,46
Real Radar	24,80	-5,30

## Targets characterization

### Remarks:

- For the large targets, the experimental protocol doesn't respect the far field approximation so there are losses in the measurements.
- Difference between the angular pitches of the reference system and of the radar makes the measurement of the reference system more precise (3 times more acquisition points).
- In the Zoe case, the discrepancies between the 2 curves and the gap between mean values can be explain by the 2 points above. The values are still comparable. Indeed, the shapes of the measurement curve and the values obtained are nevertheless comparable.
- For the case of the Zoe and of a ford focus too, The influence of the metal plate on the received signal was initially minimized by subtracting its signal alone (evaluated in another measurement campaign).
- A second approach with a new measurement campaign has been carried out every 45° of the vehicle and without metal plate. Results are currently under study => first results show equivalent values on the 4 faces for Radar ADAS results (for example, 25.5 dbm2 vs 24.8 dbm2 for the lateral side and ~7 dBm2 for both measurements of the front end signature ).

1. Methodology
2. Targets characterization (real part)
- 3. Target Modeling (virtual part)**
4. Conclusion & Next Steps

## Virtual Part : Needs and Solutions

### The needs:

A controlled environment

+

Actors and behaviours

+

A perception model

### The solutions:

An empty gymnasium +  
absorbent foam ⇔  
No simulated environment

Objects to measure ⇔ 3D modeling

Virtual Radar sensor specifications  
(Antennas positions, gain, field of view  
and simulation parameters)

— Simulation  
— Real-life



### Remarks

- For the virtual modeling of the targets, the Radar ADAS data are not used but only the measurements of the reference system and data of literature to complete when available.
- The measurements with the Radar ADAS will allow to refine and validate the virtual radar sensor.

## SE-WORKBENCH, OKTAL-SE

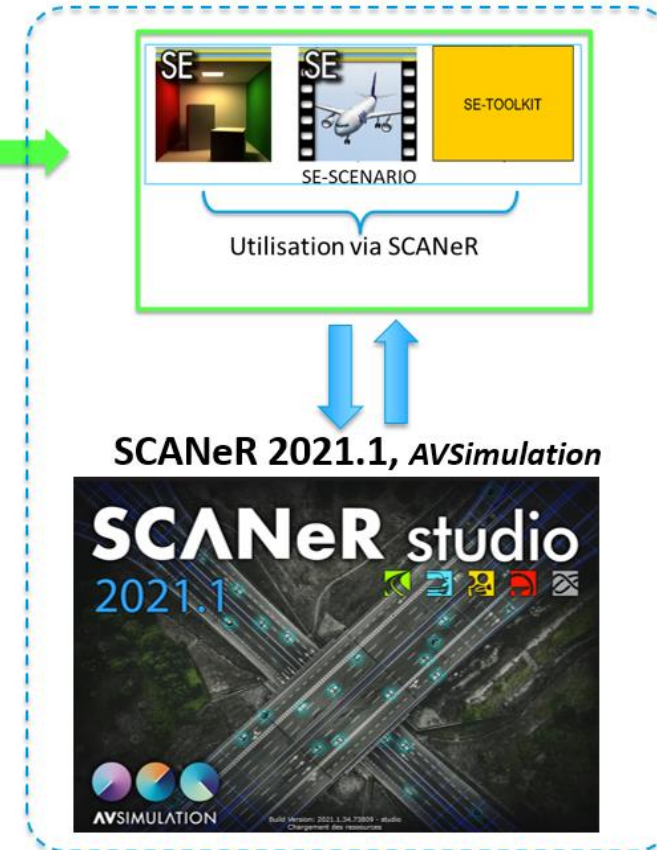
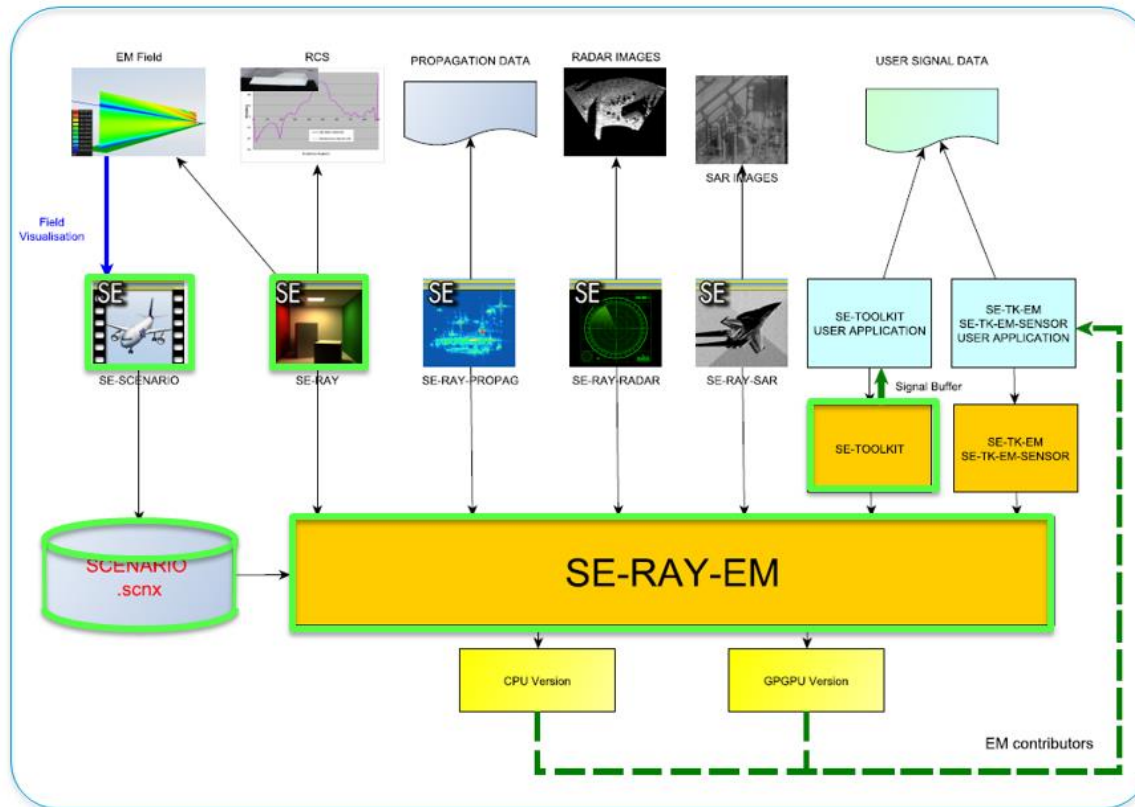

- Principle of beam interactions → RCS calculation

$$\sigma(\theta) = \frac{(4\pi)^2 R^4}{2 Z_0 P_t} |E_r(\theta)|^2$$

- $Z_0$  : vacuum impedance,
- $P_t$ : transmitted power,
- $R$ : distance between radar and target,
- $E_r()$ : module of the electric field received

The integration of OKTAL-SE plugin in SCANer studio has been validated by the correlation study of RCS simulations on canonical shape targets [3].

## Virtual Part: Target modeling Principle

### Principle of 3D modeling

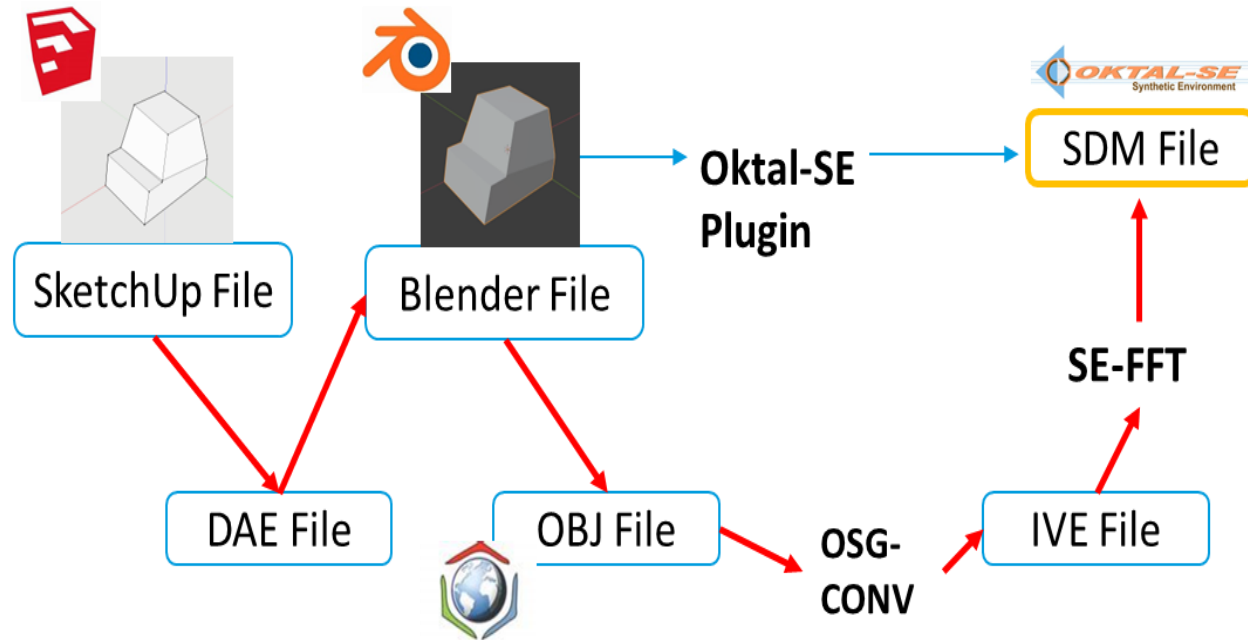

Sphere (40 mm diameter)	Dihedron (width of 60 mm)	Small Metallic Car (width of 50 mm)

Examples of 3D models of 3 little shapes

## Virtual Part: Target modeling evaluation

### Reference Target : Aluminum Trihedron

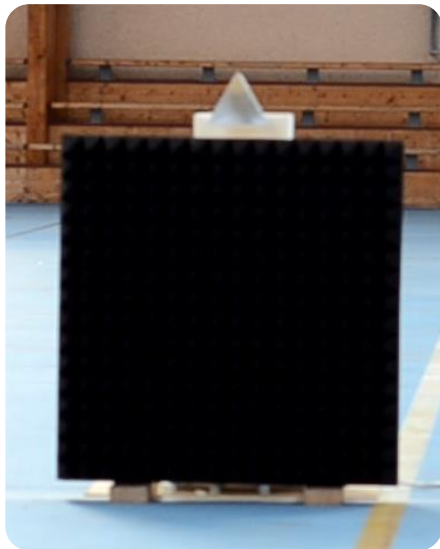

Alumium trihedron  
360° rotation



Aluminum Trihedron 3D model.  
*Construction with dimensions  
and physic properties of the real  
one*



Trihedron Radar Cross Section (dBm2) Distance 8.5 m  
=> Far field approximation respected

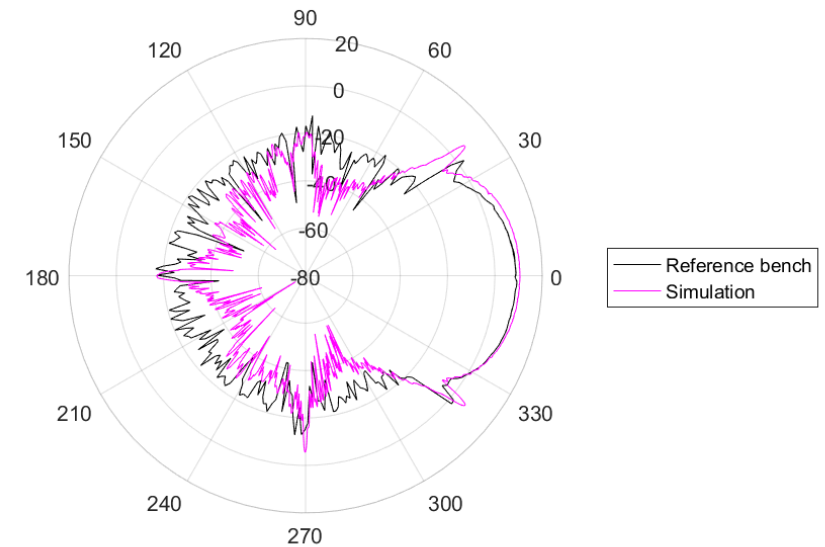

	RCS max (dBm2)	RCS mean (dBm2)
Theory	10,34	
Reference bench	9,32	-18,53
Simulation	10,65	-26,01

## Target of interest for use cases : Motorcycle



Ducati Monster  
360° rotation



Honda C350 3D modeling, similar shape to the Ducati [4] and Motorbike model used for the rolling



## Virtual Part: Target modeling evaluation

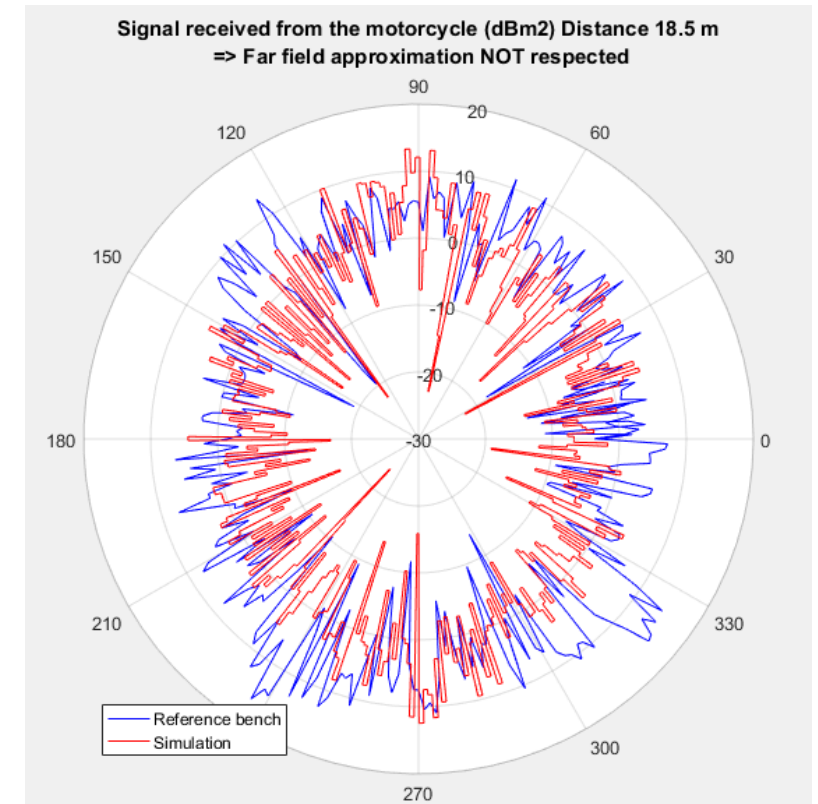

	Mean Power received (dBm2)	Max Power received (dBm2)
Reference system	2,16	16,15
Simulation	-1,44	16,28

[4] Backscattering Behavior of Vulnerable Road Users Based on High-Resolution, S. Abadpour and al. IEE Transactions on microwave and techniques

## Targets Modeling: *Remarks*

- **The differences between real and simulation measurements can be explained by:**
  - For the large targets, simulation respects real experimentation protocol, including the failure to use the far field approximation which results in measurements losses
  - There is no synthetic environment in simulation, so the received power signal is not disturbed
  - The metal plate doesn't exist in simulation
  - The virtual sensor actually defined in simulation **is ideal** unlike the reference system.
  - For the motorcycle, the 3D model is not the 3D model of the real motorcycle model.
  
- **About the correlation study:**
  - Trihedron simulation shows good fidelity to theory => the 3D model is validated
  - Motorcycle simulation has an average 3dbm2 lower than that obtained from real measurements (with the same angular pitches for both), but a maximum almost equal.
  - In view of the various points set out to justify the differences, we can consider, as a first approximation, that the 3D model of the motorcycle is sufficiently accurate for simulation. The validation will be done after finalizing the virtual reference system model (non ideal).

1. Methodology
2. Targets characterization (real part)
3. Target Modeling (virtual part)
- 4. Conclusion & Next Steps**



## Conclusion and Next Steps

### ■ Conclusion:

- Relevance workflow for target modeling
- Good correlation for the first results between real and virtual measurements
- Importance of mesh accuracy for target modeling
- Importance of ground truth knowledge of laboratory measurements
- Use case Radar scenarios are available in the MOSAR for ADESCEN scenario library

### ■ Next Steps:

1. Finalization of the virtual reference system modeling
2. Refine of insufficiently accurate 3D models (*ex: pedestrians, Renault Zoe, urban garbage can*)
3. Finalization of virtual sensor modeling
4. Finalization of use case scenarios with addition of 3D model targets and virtual sensors (including signal processing algorithm)
5. Creation of disturbance models based on experimentation data
6. Integration of disturbance models into simulation platform

# Thanks for your attention !

## Short Bibliography

- [1] Backscattering Behavior of Vulnerable Road Users Based on High-Resolution RCS Measurements. Abadpour, S. and al, IEEE Transactions on Microwave Theory and Techniques, Vol 70 Issue 4 March 2022
- [2] Permittivity Determination Method for Multilayer Automotive Coatings for Radar Application at 77 GHz, Winter, C and al., IEEE Transactions on Microwave Theory and Techniques, COL 70 NO. 4 april 2022
- [3] Virtual modeling of a radar, V.J. PALMIER and al., SIA vision 2022
- [4] Backscattering Behavior of Vulnerable Road Users Based on High-Resolution, S. Abadpour and al. *IEE Transactions on microwave and techniques*

CONTACTS:

[vanessa.palmier@irt-systemx.fr](mailto:vanessa.palmier@irt-systemx.fr)

[ammar.ridzuan@avsimulation.com](mailto:ammar.ridzuan@avsimulation.com)

[florian.faucher@irt-systemx.fr](mailto:florian.faucher@irt-systemx.fr)

[didier.gauthereau@ampere.cars](mailto:didier.gauthereau@ampere.cars)

[www.irt-systemx.fr](http://www.irt-systemx.fr)

