



**HAL**  
open science

# Development and Experimental Validation of a RC Model to Predict Indoor Air Temperature of a Room Assigned for Extreme Warm Climate: Case Study of Baitykool Prototype in Dubai

Anass Zaaoumi, Alain Sempey, Zakaria Aketouane, Patrick Sebastian

## ► To cite this version:

Anass Zaaoumi, Alain Sempey, Zakaria Aketouane, Patrick Sebastian. Development and Experimental Validation of a RC Model to Predict Indoor Air Temperature of a Room Assigned for Extreme Warm Climate: Case Study of Baitykool Prototype in Dubai. 18th IBPSA Conference on Building Simulation, Sep 2023, Shanghai, China. 10.26868/25222708.2023.1375 . hal-04687589

**HAL Id: hal-04687589**

**<https://hal.science/hal-04687589v1>**

Submitted on 5 Sep 2024

**HAL** is a multi-disciplinary open access archive for the deposit and dissemination of scientific research documents, whether they are published or not. The documents may come from teaching and research institutions in France or abroad, or from public or private research centers.

L'archive ouverte pluridisciplinaire **HAL**, est destinée au dépôt et à la diffusion de documents scientifiques de niveau recherche, publiés ou non, émanant des établissements d'enseignement et de recherche français ou étrangers, des laboratoires publics ou privés.

# Development and Experimental Validation of a RC Model to Predict Indoor Air Temperature of a Room Assigned for Extreme Warm Climate: Case Study of Baitykool Prototype in Dubai

Anass Zaaoumi<sup>1,2</sup>, Alain Sempey<sup>1,2</sup>, Zakaria Aketouane<sup>3</sup>, Patrick Sebastian<sup>1,2</sup>

<sup>1</sup>Univ. Bordeaux, CNRS, Bordeaux INP, I2M, UMR 5295, F-33400, Talence, France

<sup>2</sup>Arts et Metiers Institute of Technology, CNRS, Bordeaux INP, Hesam Universite, I2M, UMR 5295, F-33400 Talence, France

<sup>3</sup>Nobatek/INEF4, 64600 Anglet, France

## Abstract

Accurate models for building thermal behavior play a vital role in advanced control strategies of heating and cooling systems. In this paper, a gray box (RC) model is developed to predict the indoor air temperature of a room under the extreme warm climate of Dubai (United Arab Emirates). The proposed model includes the influence of cladding on the building and contains six thermal resistances and two capacities (6R2C). Then, the model parameters are identified with measurement data. The study reveals that the RC model, with consideration of the influence of cladding, leads to the best results.

## Highlights

- An artificial neural network model is used to convert hourly values of global horizontal irradiation to direct normal irradiation.
- Experimental data are used for training and identification of the RC model
- A simplified method to introduce the influence of cladding for a RC model is proposed.

## Introduction

Nowadays, the increase in global energy consumption is a vital concern. Moreover, energy and the environment are two significant issues humans face. The electricity consumption in Dubai increased from 43 093 GWh to 50 401 GWh between 2016 and 2021, while adding 3 417 MW electrical power capacity during the same period from 10 000 to 13 417 MW, indicating a sharp increase in its energy demand (DEWA 2021). The building sector represents 30.41% of the energy consumed in Dubai, which makes it one of the key areas in the issue of global warming and energy transition.

One of the most effective ways to reduce building energy consumption is to use appropriate control strategies for heating and cooling systems. Therefore, proposing models that can accurately predict building thermal behavior is crucial. Models must be both simple and reliable for real-time or predictive control applications (Viot et al. 2015).

The modeling approaches can be classified into three main types: white-box, black-box, and gray-box. White box models are the most accurate, which is the approach used by software like EnergyPlus and TRNSYS (Berthou et al. 2014). However, white box models require a significant amount of building information

such as architecture, materials used and their thermal properties, and the glazing material specifications (see (Royer et al. 2013)). Moreover, this model type is computer power demanding, making their simulation slow.

Contrary to the white-box models that try to predict the building's thermal behavior based on physics, black-box models are entirely based on historical data and statistical analysis without parameters of physical significance. Black-box models focus on finding the relationships between input and output variables independently of the building system phenomena (Amara et al. 2015). Black box models such as artificial neural networks (ANN) are widely used to predict building thermal behavior (Mechaqrane & Zouak 2004) (Afroz et al. 2017). These models can be processed much faster than white-box models and calibrated easily with the available data. However, black-box models are not able to predict building behavior in the case of new control strategies beyond the scope of their learning phase (Berthou et al. 2014). At this point, the gray box models are often preferred over the black box in the case of new control strategies. These models combine the benefit of the white and the black box models by using a combination of simplified physics and historical data. A grey-box energy model offers a balance between the accuracy of a white-box model and the speed of a black-box model. They use simpler equations than those used in white-box models to represent building behavior and then are calibrated with historical data, just like black-box models. The most common gray-box model is a resistance-capacitance (RC) or thermal-network model (Li et al. 2021).

In recent decades, many studies have been carried out using the RC approach to predict building thermal behavior. (Berthou et al. 2014) compared four RC models on their ability to predict heating and cooling demands and indoor air temperature of a multi-zone occupied office building. Out of all the models tested, the two-order R6C2 model was found to be the most efficient and able to accurately predict indoor air temperature and thermal needs during heating and cooling periods. The results indicated that for the R6C2 model, predicted data fit very well with the reference (fitting above 84% and energy error below 2%). (Viot et al. 2018) proposed an approach to obtain a suited RC model from the physical knowledge of the building and the systems to be controlled. A sensitivity analysis

method (Morris) was used to reduce the number of parameters to be identified. Their study concluded that the 5R4C model describes well the dynamics of the building and can be used for the predictive control of a floor heating system on a real building. (Kuniyoshi et al. 2018) Evaluated the accuracy of a RC building model equipped with an underfloor heating system. The performance of the 6R4C model was compared to a reference model implemented in EnergyPlus. The results indicate that the RC model has sufficient accuracy after the modifications (by changing relevant parameters) and can be used for energy and demand-side management applications. Yu et al. (Yu et al. 2019) investigated the performance of RC models based on a physical knowledge of the building to RC models using a generic model structure and black-box models. Their performance was evaluated on the long-term prediction of the thermal dynamics of an unoccupied single-family house as a test case. The model identification was based on the measurement of the indoor air temperature.

In these studies, RC models, including the influence of cladding on the building, still need to be well established. Hence, this paper investigates an RC model to predict the indoor air temperature of a room in the extreme warm climate of Dubai, with a particular focus on the influence of cladding.

This article is organized as follows. Section II describes the building geometry. Section III introduces the gray box model for modeling the studied room and explains how to calculate the solar gain that hits the outdoor walls and the one transmitted through the windows. Finally,

the last part presents the results of the solar gain model and the comparison between simulated and measured temperatures, allowing us to validate the proposed gray box model.

## Description of the living lab platform Baitykool

The study refers to a living lab platform named Baitykool. It is located in the sustainable city of Dubai, UAE (25.0294°N 55.2784°E). This sustainable prototype was developed and tested as a competition entry for the Solar Decathlon Middle East (SDME 2018) (Figure 1-a) (Samuel et al. 2020).

Baitykool is a single-floor building. The building is U shaped and has a surface of 78 m<sup>2</sup> (Figure 1-b). The house envelope works effectively to enhance the comfort conditions and is well suited to the extreme warm climate of the region. Note that Dubai has a hot arid, subtropical climate, with extremely hot summers, humid and dry, and very pleasant warm winters. The walls are composed, from the outside to the inside, of the following layers :

- Ultra High-Performance fiber Concrete (UHPC)
- Air gap
- Vapor/Rain/Reflective barrier
- Rigid insulation
- Semi-rigid insulation + wood vertical stiffeners
- Structural cross-laminated timber panel
- Composed mud bricks
- Acoustic tensed canvas

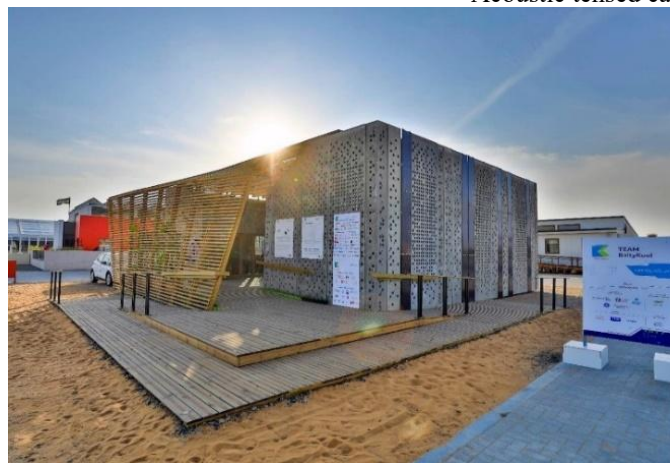

(a)



Figure 1: (a) Baitykool experimental living lab platform; (b) Baitykool plan; (c) Wall composition

The windows in Baitykool are double-glazed panels with a glazing ratio of 0.28. The building has different energetic and sustainable systems such as HVAC, photovoltaic panels, radiative sky cooling (Aketouane et al. 2022), aquaponic, gray water treatment, etc... More details about Baitykool can be found in (Samuel et al. 2020).

### Method

In this study, a gray box model is proposed to predict the indoor air temperature of a room (southeast room in Figure 1-b). Figure 2 shows the thermal network representation of the RC model, which was developed using models of the Modelica Standard Library. It contains six resistances and two capacities (6R2C). These parameters are determined from the knowledge of the physical characteristics of the room. The choice of the 6R2C model is motivated by the publication of similar works involving the same order RC model (Berthou et al. 2014). It's used for its simplicity, replicability, and few requirements of input parameters.

The network comprises five temperature nodes, representing respectively:  $T_i$ , the indoor air temperature of the thermal zone;  $T_s$ , the surfaces internal side temperature;  $T_w$ , the temperature of the wall;  $T_h$ , the surfaces external side temperature and  $T_e$ , the outdoor air temperature. For the R6C2 model, three boundary conditions are considered;  $T_e$ ,  $P_{s,e}$ , the solar heat gain that hits external surfaces, and  $P_{s,i}$ , the solar gain entering through windows. Table 1 describes the physical parameters of the R6C2 model. Their values are based on the European thermal standard, the building's technical documentation, and geometrical observations.

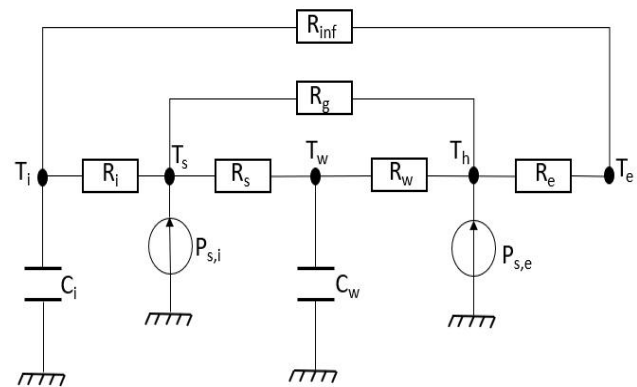

Figure 2: Schematic representation of the 6R2C model

Table 1: physical parameters of the R6C2 model

NAME	DESCRIPTION
$C_i$ (J/K)	Internal air capacitance
$C_w$ (J/K)	Wall capacitance
$R_w$ and $R_s$ (K/W)	Wall conductive resistance
$R_e$ (K/W)	External convective resistance
$R_i$ (K/W)	Internal convective resistance
$R_g$ (K/W)	Glazing resistance
$R_{inf}$ (K/W)	Infiltration resistance

To implement the 6R2C model, the following assumptions are considered:

- no air conditioning in the room
- the convective exchange coefficients are constants. For heat exchanges inside and outside the room, the coefficients  $h_i$  and  $h_e$  are equal to 5 and 10 [ $W.m^{-2}K^{-1}$ ], respectively.
- the intermediate walls are adiabatic.
- the air infiltration is constant (fixed at 7.5  $m^3/h$ )
- the occupancy is not considered.

The proposed R6C2 model has a triple advantage. First, two nodes are considered to represent the solar irradiation reaching the building ( $T_h$  and  $T_s$ ): One hits directly the outdoor surface wall ( $T_h$ ), and  $T_s$  is transmitted through the windows. Secondly, the model takes into account the influence of cladding. It should be noted that the proper consideration of the reduction of

heat gain by solar protection in front of an opaque wall such as a cladding is relevant (Dugué 2014). Therefore, it's crucial to include the influence of cladding on heat gain calculation. As shown in Figure 1-a, the cladding in front of walls differs from that of windows. The cladding in front of windows has more holes to let the light pass through it. So, we introduce two coefficients (a and b). "a" (between 0 and 1) represents the part of energy stopped by the cladding in front of the room walls, and b (between 0 and 1) the part of energy stopped by the cladding in front of the windows. Note that the cladding is created by the UHPC and the air gap (Dugué 2014). "a" and b are included in  $P_{s,e}$ , and  $P_{s,i}$ , respectively. Finally, the air infiltration resistance and glass resistance are separated and linked to the appropriate nodes.

After measured data post-processing, an identification procedure allows for finding the parameter set closest to the measured dynamics. The RC model was simulated using OpenModelica, and the identification process was done with Python.

The measurement campaign was carried out between the 17<sup>th</sup> to 27<sup>th</sup> of October 2019 in a passive situation (no air conditioning). The instrumentation of the walls is composed of hybrid temperature and hygrometry sensors SHT85 (respectively precision  $\pm 0.1^\circ\text{C}$  and  $\pm 1.5\%$ ).

A weather station (Vantage PRO 2® - Davis Instruments) is placed on the roof of the building at 10 m high. It allows recording the outdoor microclimatic conditions [Temperature (T), relative humidity (RH), wind speed ( $W_{ext}$ ), and global horizontal solar irradiation ( $I_{g,h}$ )].

### Solar gain calculation

For all types of solar applications, especially buildings, calculating instantaneous available solar gain is difficult to obtain. The 6R2C model requires solar gain at each instant of the day. This section proposes a model to estimate the solar flux that hits the outdoor walls and the one transmitted through the windows from values of different components of solar radiation, orientation angles, relative position to the sun, and time of the day.

To calculate the solar gain on outdoor walls, we need to anticipate the solar radiation on the slope surface ( $90^\circ$ ). For this purpose, we need the hourly values of solar fluxes related to the different components of solar radiation. The global irradiance on a sloped surface is given as the sum of the beam (direct), diffuse, and reflected components (Michalak 2021).

$$I_{g,s} = I_{b,s} + I_{d,s} + I_{r,s} \quad (1)$$

$I_{g,s}$  : global solar irradiance on a sloped surface,  $\text{W/m}^2$

$I_{b,s}$  : direct (beam) solar irradiance on a sloped surface,  $\text{W/m}^2$

$I_{d,s}$  : diffuse solar irradiance on a sloped surface,  $\text{W/m}^2$

$I_{r,s}$  : solar irradiance due to ground reflection on a sloped surface,  $\text{W/m}^2$

The global irradiance on a sloped surface can also be calculated from input components of horizontal irradiance by using the transposition model (Michalak 2021) :

$$I_{g,s} = I_{b,h} \cdot R_b + I_{d,h} \cdot R_d + (I_{b,h} + I_{d,h}) \cdot \rho \cdot R_r \quad (2)$$

$I_{b,h}$ : direct (beam) solar irradiance on a horizontal surface,  $\text{W/m}^2$

$I_{d,h}$ : diffuse solar irradiance on a horizontal surface,  $\text{W/m}^2$

$R_b$ : beam (direct) transposition factor

$R_d$ : diffuse transposition factor

$R_r$ : reflected transposition factor

$\rho$ : solar reflectivity of the ground and building's surroundings

The beam (direct) transposition factor can be calculated as follows (Michalak 2021):

$$R_b = \cos(\theta) / \cos(\theta_z) \quad (3)$$

Where  $\theta$  [ $^\circ$ ] and  $\theta_z$  [ $^\circ$ ] are, respectively, the angle of incidence of beam irradiance and the zenith angle. Both angles can be calculated and were discussed in detail in (Zaoumi et al. 2021).

$$\theta = \arccos(-\cos(\gamma_s) \cdot \sin(\gamma_i) \cdot \cos(\alpha_s - \alpha_i) + \sin(\gamma_s) \cdot \sin(\gamma_i)) \quad (4)$$

$$\theta_z = 90 - \gamma_s \quad (5)$$

The diffuse transposition factor can be calculated as (Michalak 2021) :

$$R_d = (1 + \cos(\beta)) / 2 \quad (6)$$

$\beta$ : Tilt angle [ $^\circ$ ]

The reflected transposition factor is given by:

$$R_r = (1 - \cos(\beta)) / 2 \quad (7)$$

It should be noted that at Baitykool's site, measurements of direct horizontal radiation and diffuse horizontal radiation are not available. Only data of global horizontal radiation exist. The formula that links the three components of solar radiation on a horizontal plane is given:

$$I_{g,h} = I_{b,h} + I_{d,h} \quad \text{with} \quad I_{b,h} = DNI \cdot \cos(\theta_z) \quad (8)$$

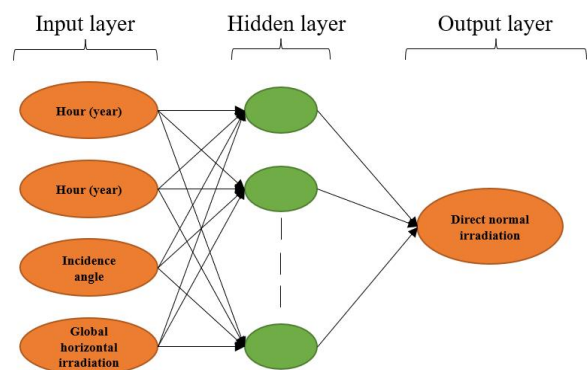

Figure 3: Architecture of the proposed ANN model.

In the following, an artificial neural network (ANN) model is used to convert hourly values of global horizontal irradiation to direct normal irradiation. This model is one of the concepts of artificial intelligence and is well suited to handle this kind of problem (Zaoumi et al. 2021). The three-layer MLP is the most popular type of ANNs. The first layer is defined as the input layer, which receives the input information and transfers the input signal to the next layer. The second layer

corresponds to the hidden layer that allows the inputs to be processed using the transfer functions. The third layer is the output layer. Figure 3 shows the architecture of the proposed ANN model. It uses hourly data of zenith angle for horizontal surface, time of the day, time of the year, and global horizontal radiation as inputs to predict hourly direct normal irradiation. The ANN model has been developed using MATLAB software.

The solar gains that hit a building element is given by:

$$P_s = I_{g,s} \cdot A_w \quad (9)$$

As discussed before, the influence of cladding is considered in the calculation. So, the new solar flow that hits the walls is as follows:

$$P_{s,e} = a \cdot I_{g,s} \cdot A_w \quad (10)$$

The solar gains that are transmitted through the windows is given by:

$$P_{s,i} = b \cdot tr \cdot I_{g,s} \cdot A_w \quad (11)$$

### Identification method of the gray box models

Through an identification process, we try to find the optimal set of parameters that minimizes an error function. The chosen error function is the Mean Squared Error (MSE). It is defined as the average squared difference between the model indoor temperature  $T_{i,m}$ , and the measured indoor temperature  $T_i$ .

$$MSE = (1/(I-N)) \cdot \sum (T_i - T_{i,m})^2 \quad (12)$$

The differential evolution algorithm is used for the identification process. This algorithm is well adapted to handle nonlinear and complex minimization problems (Soares et al. 2017).

The accuracy of the 6R2C model is evaluated by using three metrics: The Normalized Mean Biased Error *NMBE*, the Coefficient of Variation of Root Mean Square Error *CV(RMSE)*, and the coefficient of determination ( $R^2$ ) (Ruiz & Bandera 2017).

### Results and Discussions

In the following, we discuss at first the results of the ANN model. Next, we deal with the 6R2C model. Finally, we present the results of the identification process.

#### Results of the ANN model:

The ANN model was used to convert hourly values of global horizontal irradiation to direct normal irradiation and then to compare it with reference data. Data from Dubai's Typical Meteorological Year (TM<sub>Y</sub>) are used as reference data.

The ANN model is a learning-based model, and data are divided into two phases: training and validation (usually 75% of the data are used for the training process and the remaining 25 % for the validation). In the training process, the ANN model is provided with the data of the inputs and output that the network will compute, and then the errors between actual results (reference data) and those predicted (determined by ANN) are calculated.

This process aims to reduce these errors to a minimum and to define the structure of the ANN model (Zaoumi et al. 2021). The validation phase is used to estimate the ability of the ANN model to interpolate values beyond the scope of its learning phase.

To select input variables of the ANN model, we add progressively new variables and observe their influence on the model's accuracy. In this study, the selected inputs are the time of the day, time of the year, zenith angle for horizontal surface, and global horizontal radiation. The output is direct normal irradiation. The parameters of the ANN model are presented in Table 2.

Table 2 Final parameters setting of the ANN model.

Parameters	Value
Number of hidden layers	1
Number of epochs	500
Error function	MSE
Train function	trainlm (Levenberg-Marguardt)
Hidden layer function	logsig
Output layer function	tansig
Number of neurons in the hidden layer	22

Figure 4 compares DNI values obtained from reference TM<sub>Y</sub> and ANN predictions. The  $R^2$ -values for training and validation data sets are 0.9884 and 0.9723, respectively. These values correspond to a Relative Mean Square Error (RMSE) of 23.04 W/m<sup>2</sup> and 37.14 W/m<sup>2</sup>, respectively, for training and validation data sets.

Figure 5 shows the frequency distributions of the difference between reference and ANN predicted values of DNI. This frequency distribution test shows that approximately 93% of the DNI deviations are less than 40 W/m<sup>2</sup> for the training phase. This value is about 80 % for the validation phase. This test indicates that ANN model predictions can be considered accurate, especially when knowing that 88% of DNI values are above 400 W/m<sup>2</sup>.

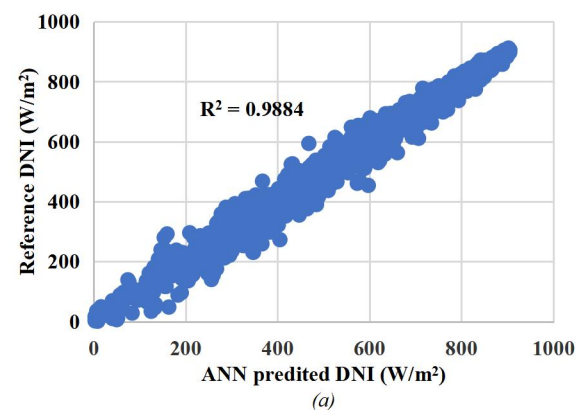

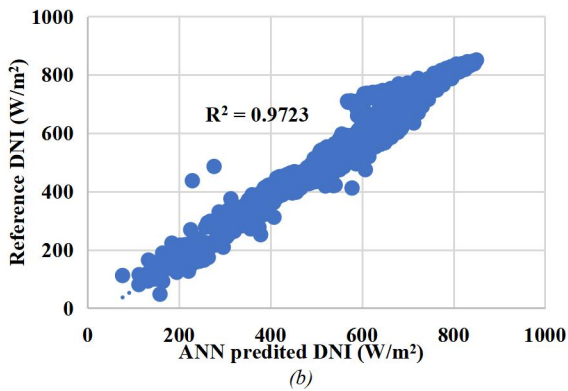

Figure 4: Reference and ANN predictions DNI for training (a) and validation (b) datasets.

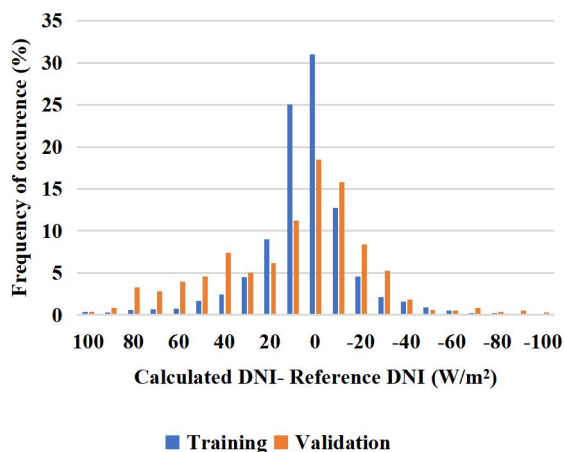

Figure 5: Frequency distributions of the differences between reference and predicted DNI

### Results of the 6R2C model:

In this part, the results of the 6R2C model are presented. The studied period is from the 17<sup>th</sup> to the 27<sup>th</sup> of October 2019. Data of global horizontal radiation, indoor and outdoor air temperature are presented in Figure 6. The outlet air temperature range is [20, 41] °C, and the inlet air temperature range is [30, 35] °C. The global horizontal irradiation values are in the range [0, 890] W/m<sup>2</sup>. Note that the 6R2C model was simulated with OpenModelica software.

Figure 7 presents a comparison between the simulation and measurement temperature of the 6R2C model for two cases. The first case corresponds to a model

considering the influence of cladding on solar gains calculation, and the second to a model without it. It can be noticed that the simulated temperature follows the general evolution of the measured indoor temperature. However, the simulated temperature has significantly higher fluctuations in the second case than in the first one. The highest relative difference value was about 5 °C for the second case and only about 1 °C for the first case. This procedure proves the importance of taking into account the influence of cladding for the RC model in building solar gains calculation. To obtain an accurate RC model, a calibration procedure of the parameters is necessary. In the next part, only the 6R2C model with the influence of cladding is considered.

To go further in the validation of the R6C2 model, an identification process is presented. The goal is to identify the parameters responsible for the influence of cladding (a, b, and h<sub>c</sub>). h<sub>c</sub> is identified because cladding decreases the heat exchanges around it. For this, we estimate the parameters between 0.2 and 0.6 for a and b. h<sub>c</sub> in an interval of 5 W.m<sup>-2</sup>.k<sup>-1</sup> to 15 W.m<sup>-2</sup>.k<sup>-1</sup>. Those intervals have been chosen so that the parameters cannot be more or less than 50% of what is believed to be their true value. For the calibration process, data are divided into two phases: Eight days for identification and the remaining four days for validation.

Figure 8 shows a better agreement between the simulated and the measurements of indoor air temperature for the identification and validation periods. The highest relative difference value was about 1 °C for the identification and validation periods. Table 3 shows the values of the NMBE, CV(RMSE), and R<sup>2</sup> indicators for the entire study period. The results obtained are promising, especially compared to ASHRAE's recommended values. For the identification period, NMBE, CV(RMSE), and R<sup>2</sup> are 0.11, 1.54, and 0.86, respectively. These values are 1.39, 2.10, and 0.83, respectively.

Table 3: Value of calibration indicators for the entire study period.

	NMBE	CV(RMSE)	R <sup>2</sup>
Identification (current study)	0.108	1.536	0.862
Validation (current study)	-1.391	2.098	0.835
ASHRAE (Ruiz & Bandera 2017), (model Calibration criteria and recommendation)	±10	30	> 0.75

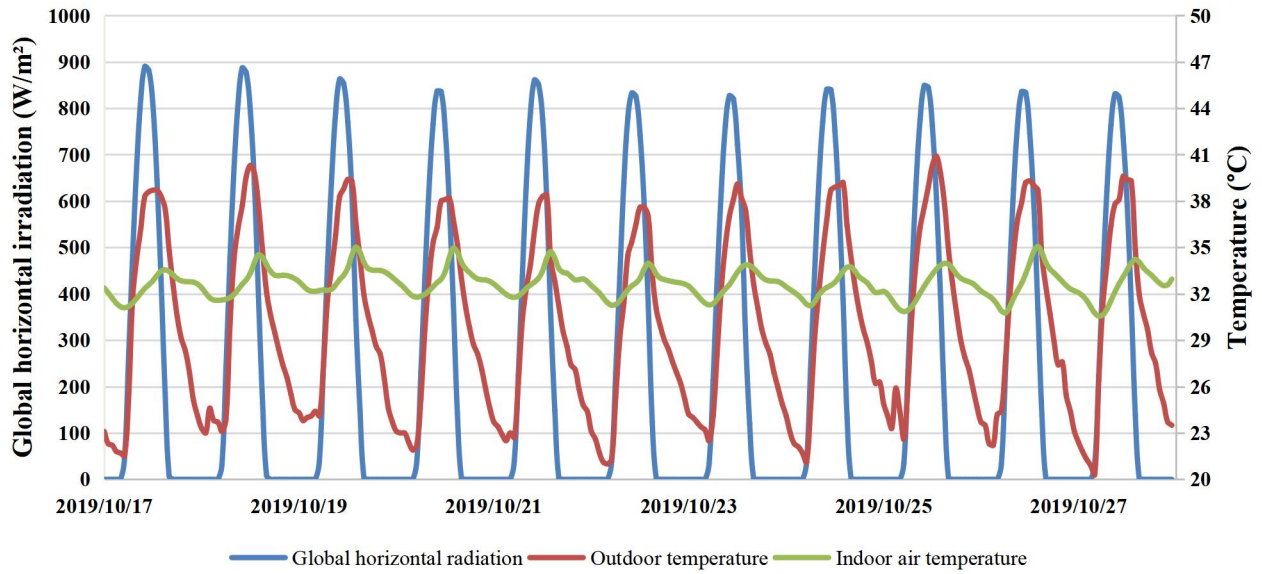

Figure 6: Representation of global horizontal irradiation, indoor and outdoor air temperature at Baitykool site. October 17-27, 2019.

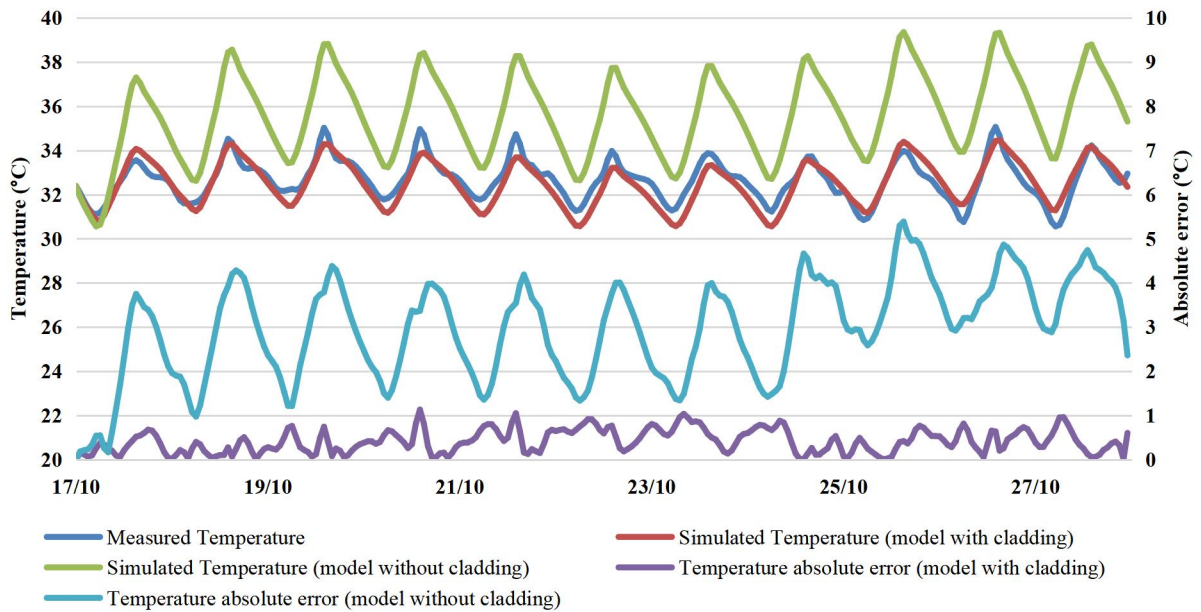

Figure 7: Indoor air temperature for the entire study period.



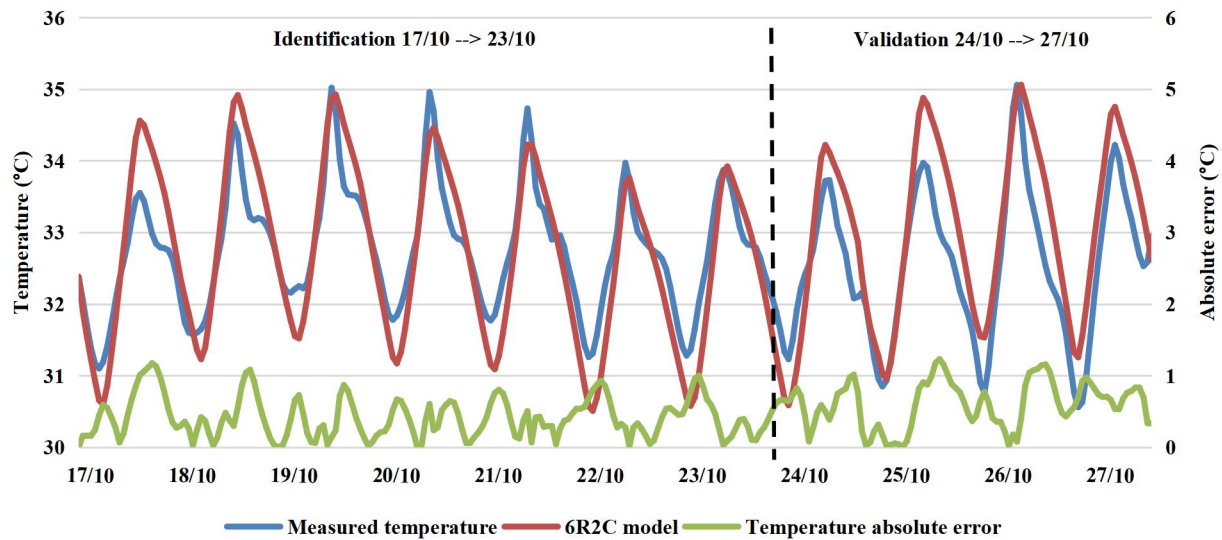

Figure 8: Indoor air temperature for identification and validation periods

## Conclusion

In this paper, an RC model is developed to predict the thermal behavior of a room and particularly the indoor air temperature under the extreme climate conditions of Dubai. The proposed 6R2C model takes into account the influence of cladding. For that, two coefficients (a and b) were chosen to quantify the influence of cladding on the solar gains for the walls and the window, respectively. Results show that the influence of cladding must be considered in developing a building gray box model. In addition, it leads to a better evaluation of the indoor air temperature. It was found that the maximum absolute temperature error is 1°C and 5°C for the RC models with and without the influence of cladding, respectively.

The selected RC model was then calibrated by identifying the most relevant parameters. The chosen parameters (a, b, and  $h_c$ ) were adjusted to increase the model accuracy. Hence, they were identified using a differential evolutionary algorithm. The identification results show that the RC model has an accuracy of 86% and 83% for the training and validation datasets, respectively. The proposed low-order gray box model, with consideration of the influence of cladding, can be used in predictive control for building energy management.

## Acknowledgement

This research was performed within the framework of the PISE project, which was funded by the Regional Council of Nouvelle Aquitaine in France within the joint research lab GP2E between I2M laboratory and technical center Nobatek/INEF4 under grant number 7762820. Also, we would like to thank the technicians and engineers of the BaityKool living lab project for their help in the implementation of the study site, the acquisition system and the data.

## References

Afroz, Z. et al., 2017. Prediction of Indoor Temperature in an Institutional Building. In *Energy Procedia*.

Elsevier Ltd, pp. 1860–1866.

Aketouane, Z. et al., 2022. Development of a night-time radiative sky cooling production & storage system: A proposal for a robust sizing and potential estimation methodology. *Applied Thermal Engineering*, 211.

Amara, F. et al., 2015. Comparison and Simulation of Building Thermal Models for Effective Energy Management. *Smart Grid and Renewable Energy*, 6(4), pp.95–112.

Berthou, T. et al., 2014. Development and validation of a gray box model to predict thermal behavior of occupied office buildings. *Energy and Buildings*, 74, pp.91–100.

DEWA, 2021. Dubai Electricity & Water Authority (DEWA) Annual Statistics. Available at: <https://www.dewa.gov.ae/en/about-us/strategy-excellence/annual-statistics>.

Dugué, A., 2014. *Caractérisation et valorisation de protections solaires pour la conception de bâtiments : analyse expérimentale et propositions de modélisations*, Available at: <https://tel.archives-ouvertes.fr/tel-00958676>.

Kuniyoshi, R., Kramer, M. & Lindauer, M., 2018. Validation of RC Building Models for Applications in Energy and Demand Side Management. In *Proceedings of eSim*. pp. 133–142.

Li, Y. et al., 2021. Grey-box modeling and application for building energy simulations - A critical review. *Renewable and Sustainable Energy Reviews*, 146, p.111174. Available at: <https://www.sciencedirect.com/science/article/pii/S1364032121004639>.

Mechaqrane, A. & Zouak, M., 2004. A comparison of linear and neural network ARX models applied to a prediction of the indoor temperature of a building. *Neural Computing and Applications*, 13(1), pp.32–37.

Michalak, P., 2021. Modelling of solar irradiance incident on building envelopes in polish climatic

- conditions: The impact on energy performance indicators of residential buildings. *Energies*, 14(14).
- Royer, S. et al., 2013. Modelling of a multi-zone building and assessment of its thermal behaviour using an energy simulation software. In *IEEE International Conference on Automation Science and Engineering*. pp. 735–740.
- Ruiz, G.R. & Bandera, C.F., 2017. Validation of calibrated energy models: Common errors. *Energies*, 10(10).
- Samuel, A.K. et al., 2020. A self-sustainable home: "BAITYKOOL" developed for the extreme warm climate an experimentation of active & passive strategies. In *2020 Advances in Science and Engineering Technology International Conferences (ASET)*. pp. 1–7.
- Soares, A. et al., 2017. A Customized Evolutionary Algorithm for Multiobjective Management of Residential Energy Resources. *IEEE Transactions on Industrial Informatics*, 13(2), pp.492–501.
- Viot, H. et al., 2015. Fast on-site measurement campaigns and simple building models identification for heating control. In *Energy Procedia*. Elsevier Ltd, pp. 812–817.
- Viot, H. et al., 2018. Model predictive control of a thermally activated building system to improve energy management of an experimental building: Part I—Modeling and measurements. *Energy and Buildings*, 172, pp.94–103.
- Yu, X. et al., 2019. Investigation of the model structure for low-order grey-box modelling of residential buildings. In *Building Simulation Conference Proceedings*. International Building Performance Simulation Association, pp. 5076–5083.
- Zaaoumi, A. et al., 2021. Estimation of the energy production of a parabolic trough solar thermal power plant using analytical and artificial neural networks models. *Renewable Energy*, 170, pp.620–638.