



HAL
open science

Infrared vibrothermography of sand

Minh-Phong Luong

► **To cite this version:**

Minh-Phong Luong. Infrared vibrothermography of sand. AITA 2005 Advanced Infrared Technology and Applications, 2005, Rome, Italy. pp.1-8. hal-04685475

HAL Id: hal-04685475

<https://hal.science/hal-04685475>

Submitted on 3 Sep 2024

HAL is a multi-disciplinary open access archive for the deposit and dissemination of scientific research documents, whether they are published or not. The documents may come from teaching and research institutions in France or abroad, or from public or private research centers.

L'archive ouverte pluridisciplinaire **HAL**, est destinée au dépôt et à la diffusion de documents scientifiques de niveau recherche, publiés ou non, émanant des établissements d'enseignement et de recherche français ou étrangers, des laboratoires publics ou privés.



Distributed under a Creative Commons Attribution 4.0 International License

INFRARED VIBROTHERMOGRAPHY OF SAND

M.P. Luong¹

¹ CNRS-LMS Ecole Polytechnique F-91128 Palaiseau France
Email : luong@lms.polytechnique.fr

The paper introduces infrared thermography as a non-contact and non-destructive technique that conveniently offers the possibility of evaluating the energy-dissipating ability of soil, generally difficult to be determined using traditional techniques. It allows records and observations in real time of heat patterns produced by the dissipation of energy caused by friction between grains. Such dissipative heat occurs when soil is subjected to vibratory loading exceeding the characteristic threshold, and it evidences the distortion mechanism. This energy dissipation mechanism influences the wave propagation, intergranular attenuation, and dispersion through particles contacts. The infrared thermographic technique, which couples mechanical and thermal energy, offers the potential of directly monitoring the stress state of particle rearrangement and predicting the macroscopic mechanical response of soils subjected to cyclic, dynamic or vibratory loading. In addition, infrared thermography evidences the fuse effect of soil, capable to mitigate significantly the earthquake loading on engineering structures.

Introduction

Mechanical engineering deals with various types of materials (metals, concrete, soils, rocks, composites, etc.), structural components and/or constructions. To optimize the reliability of research and development, the process is well known : *diverse thermal phenomenological manifestations followed by theoretical models are obtained intuitively from experience*. These must subsequently be *validated* : their predictions concerning the application are confronted with the relevant experimental results.

Thermomechanical coupling effects in engineering materials and structural components have traditionally been neglected in thermal stress analyses. The temperature field and the deformation induced by thermal dilation and mechanical loads were solved separately. However this effect could become significant when mass inertia is not negligible, due to the flux of heat generated through the boundary of the body, or if the material is loaded beyond its stable reversible limit. The relevance of coupled thermomechanical analysis has been

demonstrated for a variety of problems, such as fault analysis of nuclear reactors, damping of stress wave propagation, deformation localization after bifurcation, and strength softening of materials due to the heat generated by repeated plastic deformations.

Internal energy dissipation was recognized in literature [Bui, Ehrlacher & Nguyen 1987, Farren & Taylor 1925, Luong 1986 and 2001b, Mandel 1980, Maugin 1992, Raniecki & Sawczuk 1975, etc.]. Carrying out experiments on the cyclic twisting of cylindrical bars, Dillon [1963] identified the work done to the system by plastic deformation as the major contribution to the heat effect, and proposed an internal dissipation rate \dot{D} related to plastic strain rate. The thermal effect due to thermomechanical coupling at the tip of a moving crack has been investigated [Bui, Ehrlacher & Nguyen 1981] within the framework of thermodynamics, taking into account stress and strain singularities. The heat generated due to plastic deformation causes a large local temperature increase which is expected to affect the selection of failure modes during dynamic fracture and thus to influence the fracture toughness of the material. Well-developed empirical theories of

plastic deformation in metals allowed engineers to predict successfully the behavior of a variety of structures and machine elements loaded beyond the elastic limit for purposes of design.

Background of thermomechanical coupling in solids

Infrared thermography is a convenient technique for producing heat images from the invisible radiant energy emitted from stationary or moving objects at any distance and without surface contact or in any way influencing the actual surface temperature of the objects viewed. The temperature rise ahead of a fatigue crack has been measured using a thermographic camera in order to demonstrate the local heating at the tip. Attempts have been made to measure and characterize the heat generated during the cyclic straining of composite materials. The scanning infrared camera has been used to visualize the surface-temperature field on steel [Luong 1995a], wood [Luong 1999], engineering materials [Luong 1990] and Fiberglass-epoxy composite samples during fatigue tests. Recently this infrared thermographic technique has been applied in sport engineering [Luong 2001a, Luong & Parganin, 1999]. A consistent theoretical framework is necessary in order to interpret correctly the thermal images.

In the thermodynamics of irreversible processes, the development of thermo-elastic-plasticity equations leads to the coupled thermomechanical equation [Kratovich & Dillon 1969]:

$$\rho C_v \theta_{,t} = \rho r + \text{div} (k \text{ grad} \theta) - (\beta : \mathbf{D} : \mathbf{E}^e)_{,t} \theta + \mathbf{S} : \mathbf{E}^I_{,t}$$

where ρ denotes the mass unit in the reference configuration, C_v the specific heat at constant deformation, T the absolute temperature, r the heat supply, k the thermal conductivity, div the divergence operator, grad the gradient operator, β the coefficient of the thermal expansion matrix, $:$ the contracted product operator of second order tensors, \mathbf{D} the fourth-order elasticity tensor, \mathbf{E}^e the elastic strain tensor, \mathbf{S}

the second Piola-Kirchhoff stress tensor and \mathbf{E}^I the inelastic strain tensor. The $\theta_{,t}$ stands for the material time derivative of temperature. The volumetric heat capacity of the material $C = \rho C_v$ is the energy required to raise the temperature of a unit volume by 1°Celsius (or Kelvin degree).

Since the physical process underlying the problem is highly diversified, the modeling is thus approached from a purely phenomenological point of view. Such an approach can be useful in the interpretation of the energetics of the thermoelasticplastic behavior. The classical theory of rate-independent isotropic or kinematical hardening plasticity is considered to be an adequate basis for such modeling as it offers the simplest constitutive model for elastic behavior of the material while still allowing consistent inclusion of two-way thermomechanical coupling effects. When using internal state variables \mathbf{IV} that describe structural changes of material, the right hand side member will be completed by others terms (reversible and irreversible terms for each internal variable) representing the cross coupling effects [Duszek & Perzyna 1991]. These effects influence the evolution of temperature through the second order terms when compared with the internal dissipation term. Their contribution to internal heating during the adiabatic process is small and so they are sometimes neglected.

This coupled thermomechanical equation suggests the potential applications of the infrared scanning technique in diverse engineering domains: detection of fluid leakage [Luong & Martin 1990, Weil 2001], nondestructive testing using thermal conduction phenomena, elastic stress measurements [Beaudoin, Bissieux & Offerman 2001], and localization of dissipative phenomena [Luong 1982]. Thus the detected temperature change, resulting from four quite different phenomena (heat sources, conduction effect, reversible thermo-elastic coupling and intrinsic dissipation), must be correctly discriminated by particular test conditions and/or specific data reduction. This is the main difficulty when interpreting the thermal images obtained from experiments under the usual conditions.

Soil dynamics in seismic areas

A problem of practical importance for the foundation engineer in urban areas is the protection of structures against ground-transmitted waves generated by earthquake hazards or other vibrations such as external traffic, machinery, blasting, causing disturbances to adjacent structures. Most of the vibratory energy affecting structures nearby is carried by surface waves that travel in a zone close to the ground surface. Soil may act as a vibration transmitter, thereby modifying the intensity, frequency content and spatial distribution of ground shaking and it therefore induces the structural damage. It is then possible to reduce the ground-borne vibrations significantly by placing a suitable wave barrier in the ground around the structure.

The conventional method aims to determine the G shear modulus and the D damping ratio of soil. Several studies provided data for use in visco-elastic, hysteretic or Ramberg-Osgood models. Recently the results of a micromechanical study of internal energy dissipation due to slip between contacting granules, introduced by Okada & Nemat-Nasser [1994], have been successfully compared with experimental measurements.

This paper proposes the use of infrared thermography capable to recognise quantitatively the energy-dissipating ability of soils.

Characteristic threshold

Rheological properties of granular soils can be interpreted at the grain level where the solid particles interact with one another leading to a global aggregation (contractancy) or disaggregation (dilatancy) [Luong 1980]. The characteristic threshold is readily revealed by the appearance of a dilatancy loop when the load cycle crosses the grain interlocking threshold called characteristic state or zero dilatancy threshold.

Such observations enable the determination of both the entanglement capacity of a granular material and its energy-dissipating ability.

Below the characteristic threshold, the intergranular contacts are stable. The limited slidings tend toward a maximal aggregation. In this subcharacteristic domain or contractancy zone, a hysteresis loop occurs when reloading. Above the characteristic threshold, the grain contacts become unstable, leading to significant sliding due to interlocking breakdown. A reload shows a dilatancy loop with memory loss of load history and a softening phenomenon occurs. The characteristic threshold corresponds in these conditions to the stress threshold where phenomena of disaggregation occur and allow the dissipation of energy, generated by relative sliding friction between solid particles.

Energy dissipating mechanism

When a siliceous sand grain slides against another one, there occurs a motion resistance called friction. Bowden and Tabor [1959] demonstrated that when quartz or glass surface slides over another one in the dark, small sparkling points of light could be seen at the interface. The friction between grains generates heat. A consideration of forces and deformations at each surface [Mindlin & Deresiewicz 1953] may serve as a starting point in interpreting the thermomechanical coupling of sand behaviour under vibratory shearing (Fig. 1).

For the simplest case of two like spheres compressed statically by a force, which is directed along their line of centres, normal to their initial common tangent plane, the contact theory, after Hertz, predicts a plane, circular contact radius. When an additional tangential force is applied in the plane of contact, the Mindlin's solution shows that the tangential tension is parallel to the displacement and increases without limit on the bounding curve of the contact area.

In accordance with Coulomb's law of sliding friction, slip is assumed to be initiated at the edge of the contact and to progress radially inward, covering an annular area. An annulus of counter-slip is formed and spreads radially inward as the tangential force is gradually decreased. The inelastic character of the unloading process appears evident since the

annulus of the counter-slip does not vanish when the tangential force is completely removed. Under oscillating tangential forces, the load-displacement curve forms a closed loop traversed during subsequent force oscillations between the limits providing that the normal force is maintained constant. The area enclosed in the loop represents the frictional energy, dissipated in each cycle of loading. For small tangential forces, it has been suggested that the tangential displacement, necessary to relieve the singularity in tension, takes the form of an elastic deformation of the asperities. An increase in applied tangential force causes the asperities at the edge of the contact surface to deform plastically through relatively large strains, a process that leads to a marked increase in energy dissipation and to severe damage to the surfaces.

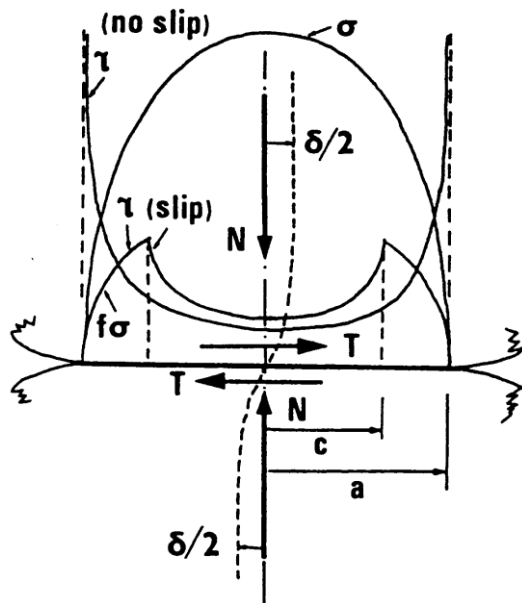

Fig. 1. Stress and strain on contact surface of two like spheres subjected to normal force N followed by a tangential force T .

Thus at small amplitude of the tangential force, energy is dissipated as a result of plastic deformation of a small portion of the contact surface, whereas at large amplitude the Coulomb sliding effect predominates.

In the conventional triaxial test (Fig. 2), if the load is cycled within the subcharacteristic domain below the characteristic threshold, the intergranular contacts remain stable. Small slips lead to a maximum entanglement caused by the

relative tightening of constituent grains. The dissipated work given by the hysteresis loop (a) is relatively small. The corresponding heat production is relatively low and negligible.

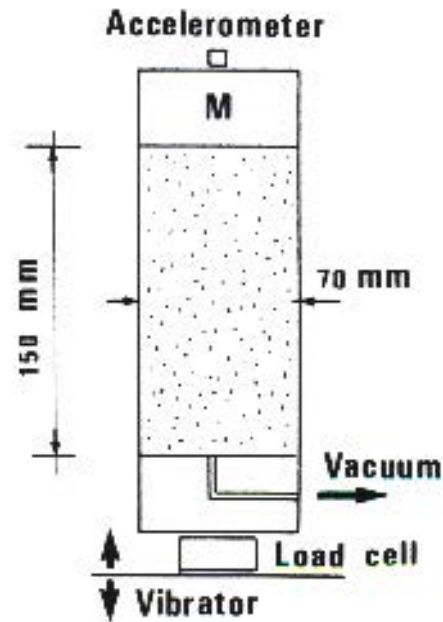

Fig. 2. Triaxial test on a dry siliceous fine sand.

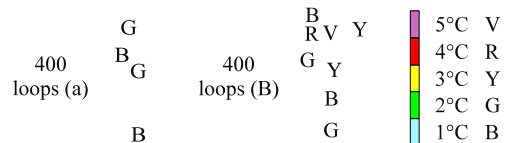

Fig. 3. Heat due to intrinsic dissipation of a fine sand under vibratory shearing.

On the contrary, when the shear load is cycled at large amplitude exceeding the characteristic thresholds (in compression q_c^+ and in extension q_c^-), the intergranular contacts become unstable, leading to significant slidings caused by interlocking breakdown. A large frictional energy (B) is dissipated and is transformed almost entirely into heat owing to the

thermomechanical conversion. If the stress peaks in triaxial compression and extension are not exceeded, the resultant effect is densification because the high amplitude loading benefits in partial loss of strain-hardening during the dilating phase in the supercharacteristic domain, leading to a breakdown of the granular interlocking assembly. On each reload, the tightening mechanism induces new irreversible volumetric strains and recurs each time with a renewed denser material. This case is particularly interesting when energy needs to be dissipated without risk of soil failure (Fig. 3).

Infrared vibrothermography of a fine siliceous sand

Infrared thermography has been successfully employed as an experimental method for detection of plastic deformation during crack propagation under monotonic loading of a steel plate or as a laboratory non-intrusive technique for investigating damage, fatigue, creep, and failure mechanisms [Luong 1995a].

The heat dissipation, evidenced here, is associated with a plastic work of distortion. This technique is sensitive, non-destructive and non-contact, thus ideally suited for records and observations in real time of heat produced by the heat transformation of energy caused by friction between grains of sheared sandy soil. No interaction at all with the specimen is required to monitor the thermal gradient. Soil presents a very low thermomechanical conversion under monotonic loading.

However plastic deformation, whereby sliding between grains occurs creating permanent changes globally or locally, is one of the most efficient heat production mechanisms. Most of the energy that is required to cause such plastic deformation is dissipated as heat. Such heat generation is more easily observed when it is produced in a fixed location by reversed or alternating sliding because of vibratory reversed applied loads.

These considerations define the use of vibrothermography as a non-destructive method for observing the energy-dissipation ability of granular material. A scanning camera was used,

which is analogous to a television camera. It utilizes an infrared detector system in a sophisticated electronics system in order to detect radiated energy, and to convert it into a detailed real-time thermal picture in a video system both colour and monochromatic. Responses times are shorter than a microsecond.

Experimental results

The thermal dissipation behaviour of a fine Fontainebleau sand has been studied when subjected to two types of vibratory loading.

Direct shearing: A tubular specimen of dry sand (Fig. 4), characterised by its dry unit weight $\gamma_d = 15.7 \text{ kN.m}^{-3}$, its void ratio $e = 0.72$ and its relative density $I_D = 0.62$ confined under a constant isotropic pressure of 50 kPa, is directly sheared by a concentric steel cylinder excited in an axial vibratory motion by the electrodynamic generator. In this case of solicitation, the principal stress axes rotate during loading.

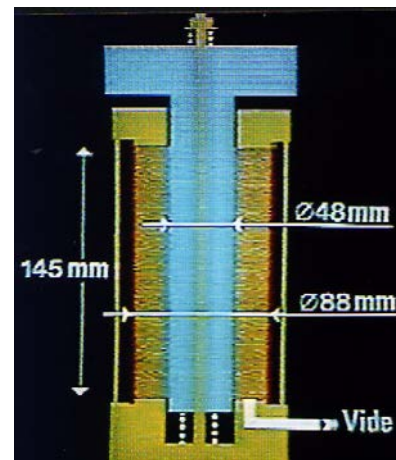
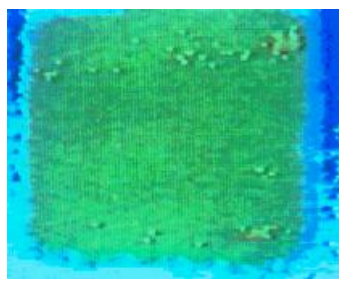

Fig. 4. Dry siliceous sand under direct shearing.



20 % CT



50 % CT

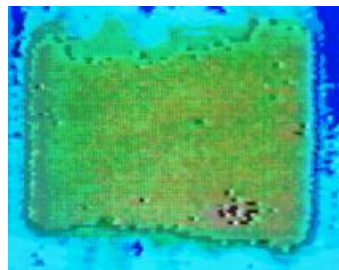

60 % CT

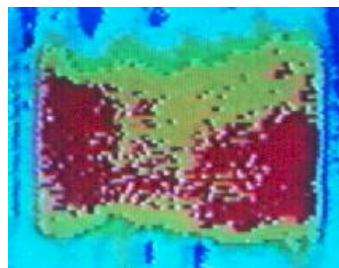

90 % CT

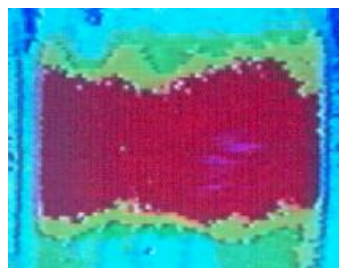

105 % CT

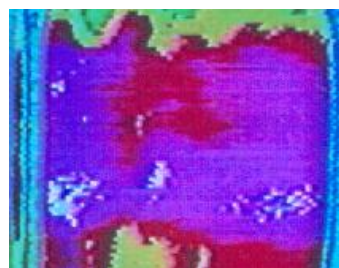

110 % CT

Fig. 5. Intrinsic dissipation of a dry siliceous sand under direct shearing.

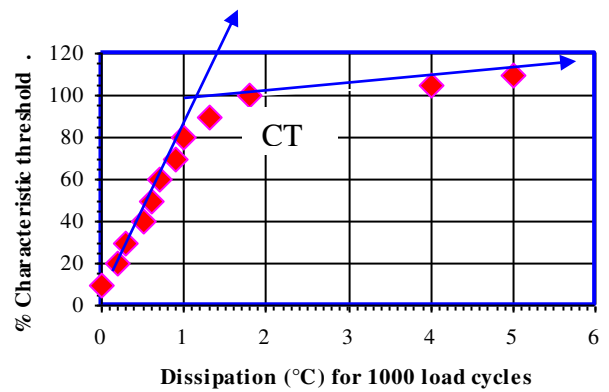

Fig. 5. Characteristic threshold CT of a dry siliceous sand under direct shearing.

At the frequency of 80 Hz and with a controlled displacement of 1 mm, the characteristic threshold is exceeded and hot colours caused by heat production by friction between siliceous grains appear as shown in the Fig. 5. The temperature increase is about 6° C for a test duration of 20 sec. The stress deviator / dissipation plot (Fig. 6) defines precisely the characteristic threshold of the dry siliceous sand subject to direct shearing, from where the material dissipates mechanical energy, generated by Coulomb friction between constituents grains at granular contacts.

Indirect shearing: A cylindrical specimen of dry fine sand (Fig. 7), characterised by its dry unit weight $\gamma_d = 15.7 \text{ kN.m}^{-3}$, its void ratio $e = 0.72$ and its relative density $I_D = 0.62$ and confined under a constant isotropic pressure of 100 kPa, is subjected to a vibratory axial force, generated by a steel mass located on the top of the specimen and excited by an electromagnetic vibrator.

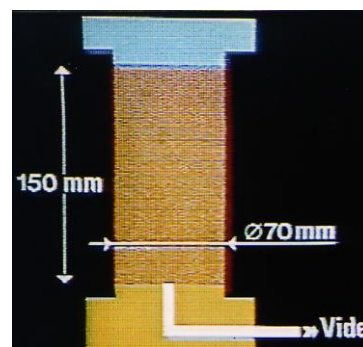
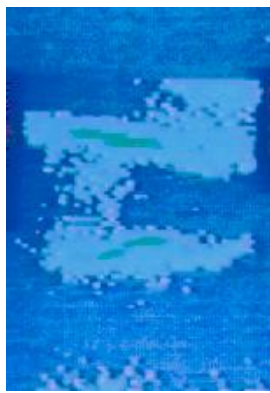
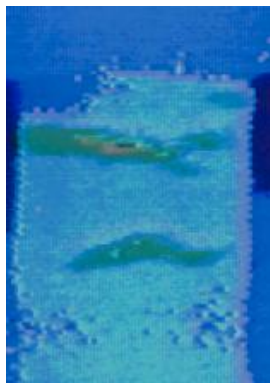

Fig. 7. Dry siliceous sand under indirect shearing.



20 % CT



50 % CT



80 % CT



100 % CT



120 % CT

Fig. 8. Infrared vibrothermography of a dry siliceous sand under indirect shearing.

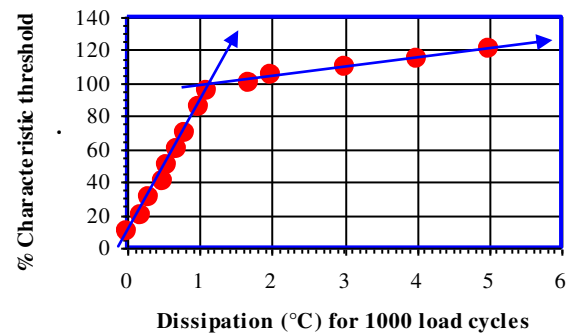

Fig. 7. Characteristic threshold CT of a dry siliceous sand under indirect shearing.

When the frequency reaches 87 Hz with a controlled displacement of 1 mm at the base, the specimen (70 mm in diameter and 150 mm high) is subjected to stationary stress waves and presents a striction zone where the deviator stress level η exceeds the characteristic threshold η_c of interlocking breakdown of the granular structure (Fig. 6).

Concluding remarks

This experimental study aims to interpret the physical and mechanical properties of sand, at the macroscopic level, in relation with the deformation mechanisms occurring at the granular level. The characteristic state concept reveals to be quite suitable for determining the threshold of interlocking breakdown of soil and also for analysing its applicability to earthquake-

resistant or vibration-isolating foundations. A non-destructive testing technique, using infrared vibrothermography, has evidenced the intrinsic dissipation of a fine sand, caused by friction between grains.

This energy dissipation mechanism influences the wave speed, intergranular attenuation, and dispersion through particle contacts. Particularly in region of high seismicity, it eventually suggests the concept of geotechnical fuse [Luong 1994 & Luong 1995b] capable to mitigate the earthquake actions on engineering structures.

References

1. J.L. Beaudoin, C. Bissieux and S. Offerman. Thermoelastic stress analysis. *Infrared and Thermal Testing*, ASNT NDT Handbook Vol. 3, Chap. 11, Part 7, pp. 339-341, 2001.
2. F.P. Bowden & D. Tabor. Friction and lubrication. *Dunod*, Paris, 1959.
3. H.D. Bui, A. Ehrlacher & Q.S. Nguyen. Etude expérimentale de la dissipation dans la propagation de la fissure par thermographie infrarouge. *C.R. Acad. Sci. Tome 293*, Série II, pp. 1015-1017, 1981.
4. H.D. Bui, A. Ehrlacher and Q.S. Nguyen. Thermomechanical coupling in fracture mechanics. *Thermomechanical Coupling in Solids*. H.D.Bui and Q.S.Nguyen ed., Elsevier Sci. Pub., IUTAM, pp. 327-341, 1987.
5. O.W.Jr Dillon. Coupled thermoplasticity. *J. Mech. Phys. Solids*. Vol. **11**, pp. 21-33, 1963.
6. M.K. Duszek & P. Perzyna. The localization of plastic deformation in thermoplastic solids. *Int. J. Solids Structures*, Great Britain, **27**, N° **11** pp. 1419-1443, 1991.
7. W.S. Farren and G.I. Taylor. The heat developed during plastic extension of metals. *Proc. Roy. Soc. Series A*, Vol. **107**, pp. 422-428, 1925.
8. J. Kratochvil & O.W.Jr Dillon. *Thermodynamics of elastic-plastic materials as a theory with internal state variables*, *J. Appl. Phys.*, 40, 3207-3218 (1969).
9. M.P. Luong. Stress-strain aspects of cohesionless soils under cyclic and transient loading. *Soil Under Cyclic and Transient Loading*. Balkema, pp. 315-324, 1980.
10. M.P. Luong. Détection par thermographie infrarouge du seuil caractéristique d'un sable cisailé en vibrations. *C.R. Acad. Sci. Tome 295*, Série II, pp. 87-90, 1982.
11. M.P. Luong. Characteristic threshold and infrared vibrothermography of sand. *Geotechnical Testing J.* ASTM, June, pp. 80-86, 1986.
12. M.P. Luong. Infrared thermographic characterization of engineering materials. *SPIE Proc. Series*. Vol. **1314**, Infrared Technology XVI, pp. 275-284, 1990.
13. M.P. Luong. Centrifuge simulation of Rayleigh waves in soils using a drop-ball arrangement. *Dynamic Geotechnical Testing II*. Ed. R.J. Ebelhar, V.P. Drnevich & B.L. Kutter, Philadelphia, ASTM STP 1213, pp. 385-399, 1994.
14. M.P. Luong. Infrared thermographic scanning of fatigue in metals. *Nuclear Engineering Design*, 158, pp. 363-376, 1995a.
15. M.P. Luong. Efficiency of an energy-dissipating barrier. *Recent Advances Geotechn. Earthquake Engng & Soil Mechanics*. St Louis, **I**, pp. 127-134, 1995b.
16. M.P. Luong. Infrared scanning of failure processes in wood. *Selected SPIE Papers*, ed. by John R. Snell & Douglas D. Burleigh, CD-ROM series in PDF, Vol. **7**: Thermal Sensing and Imaging, April 1999.
17. M.P. Luong. Infrared observations of the mechanical performance of tennis strings. *Thermosense XIII*, Proc. SPIE Vol. 4360, pp. 624-635, 2001a.
18. M.P. Luong. Thermomechanical couplings in solids. *Infrared and Thermal Testing*, ASNT NDT Handbook Vol. 3, Chap. 11, Part 8, pp. 342-347, 2001b.
19. M.P. Luong et A. Martin. Détection de microfuites par thermographie infrarouge. *Actes ASTELAB 90*. Colloque International Essais Industriels, Coopération Européenne, Paris, Juin, 1990.
20. M.P. Luong and D. Parganin. Infrared scanning of damage in leather. *Selected SPIE Papers*, ed. by John R. Snell & Douglas D. Burleigh, CD-ROM series in PDF, Vol. **7**: Thermal Sensing and Imaging, April, 1999.
21. J. Mandel. Variables cachées, puissance dissipée, dissipativité normale. *Thermodynamique des comportements rhéologiques*. Sc. et Techn. Armement, Special Issue, pp. 37-49, 1980.
22. G.A. Maugin. *The Thermomechanics of Plasticity and Fracture*. Cambridge Texts in Applied mathematics, Cambridge University Press, 1992.
23. R.D. Mindlin & H. Deresiewicz. Elastic spheres in contact under varying oblique forces. *J. Applied Mechanics*, **20**, pp. 327-344, 1953.
24. N. Okada & S. Nemat-Nasser. Energy dissipation in elastic flow of saturated cohesionless granular media. *Géotechnique*, **44**(1), pp. 1-19, 1994.
25. B. Raniecki and A. Sawczuk. Thermal effects in plasticity. *Z. Angew. Math. Mech.* Vol. **55**, pp. 333-341, 363-373, 1975.
26. G.J. Weil. Techniques of infrared thermographic leak testing. *Infrared and Thermal Testing*, ASNT NDT Handbook Vol. 3, Chap. 18, Part 1, pp. 602-608, 2001.