



HAL
open science

Elaboration of BaTiO₃ piezoceramics by Direct Ink Writing for acoustic application

Naël Mezdar, Laurence Seveyrat, Ana Borta-Boyon, Laurent Gremillard,
Pierre-Jean Cottinet

► **To cite this version:**

Naël Mezdar, Laurence Seveyrat, Ana Borta-Boyon, Laurent Gremillard, Pierre-Jean Cottinet. Elaboration of BaTiO₃ piezoceramics by Direct Ink Writing for acoustic application. The young Ceramists Additive Manufacturing Forum, Aug 2023, Leoben, Austria. hal-04681393

HAL Id: hal-04681393

<https://hal.science/hal-04681393v1>

Submitted on 16 Sep 2024

HAL is a multi-disciplinary open access archive for the deposit and dissemination of scientific research documents, whether they are published or not. The documents may come from teaching and research institutions in France or abroad, or from public or private research centers.

L'archive ouverte pluridisciplinaire **HAL**, est destinée au dépôt et à la diffusion de documents scientifiques de niveau recherche, publiés ou non, émanant des établissements d'enseignement et de recherche français ou étrangers, des laboratoires publics ou privés.

Elaboration of BaTiO₃ piezoceramics by Direct Ink Writing for acoustic applications

THALES

INSA INSTITUT NATIONAL DES SCIENCES APPLIQUÉES LYON LGEF

N. MEZDAR^{1,2,3}, L. SEVEYRAT¹, A. BORTA-BOYON⁴, L. GREMILLARD³, P.-J. COTTINET¹

¹ INSA Lyon, LGEF, UR682, 69621 Villeurbanne, France

² Thales Defense Missions Systems, 06560 Valbonne, France

³ INSA Lyon, Université Claude Bernard Lyon 1, CNRS, MATEIS, UMR5510, 69621 Villeurbanne, France

⁴ Thales Research and Technology, 91120 Palaiseau, France

MatéIS
Matériaux
Informatique
et
Science
UMR 5510

INSTITUT CARNOT
Ingénierie@Lyon

Introduction

Application of piezoelectric materials in sonars

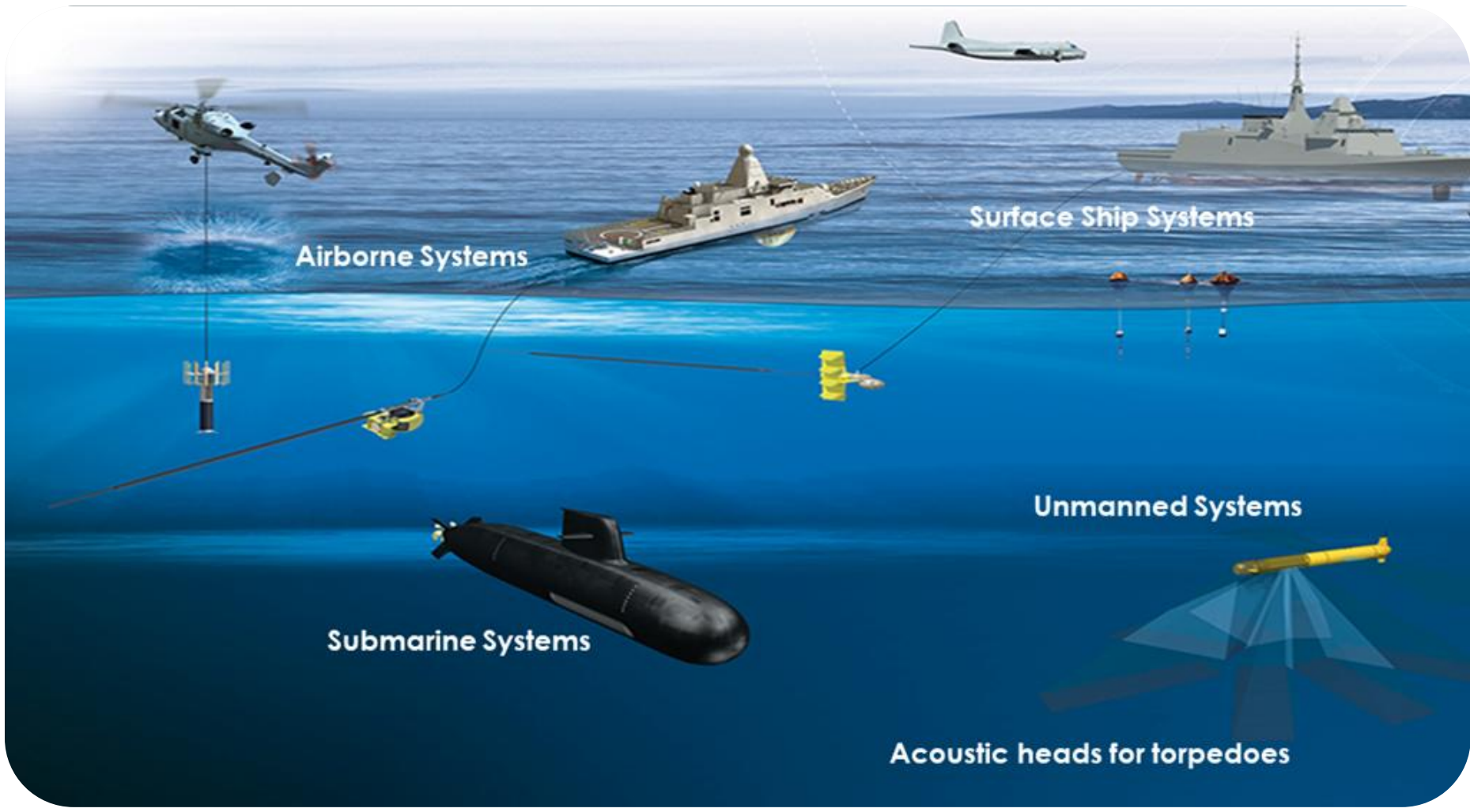

Manufacturing of sonars for detection and underwater 3D imaging devices

Piezoelectric effects

(1) **direct piezoelectric effect** :

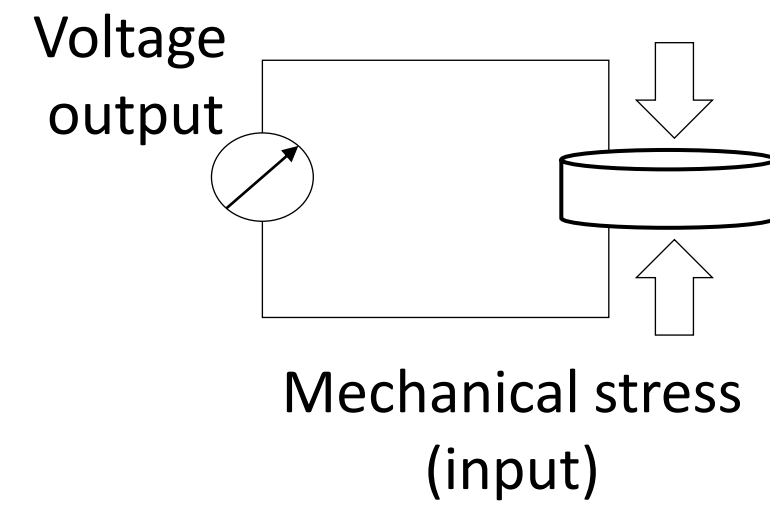

(2) **inverse piezoelectric effect** :

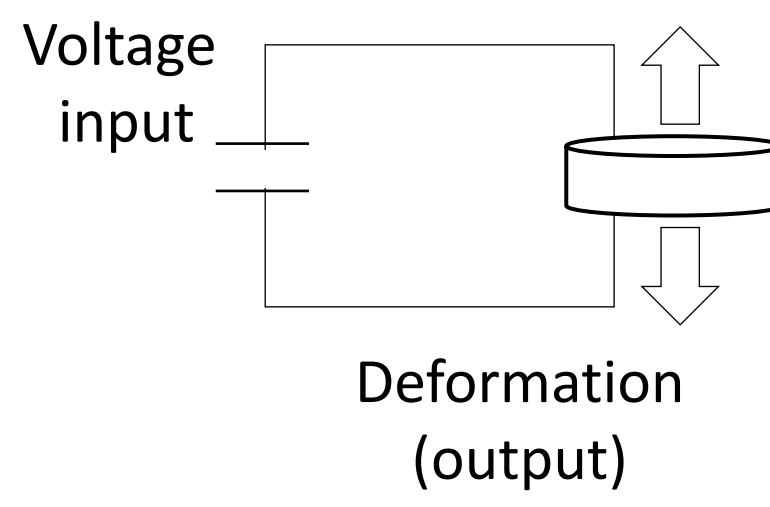

Widely used ceramics
Pb(Zr_{1-x}Ti_x)O₃ (PZT)

European Union restricts the use of lead

⇒ RoHS (2006)
⇒ REACH (2012)



Development new lead-free piezoceramics

- Improve sonars' transducers responses by use of complex structures
- Use of new technologies to obtain more complex structures and reduce the fabrication wastes

SCOPE: 3D printing of a lead-free piezoelectric ceramic by Direct Ink Writing

Ceramic manufacturing process

Conventional shaping methods

Subtractive manufacturing for complex geometries

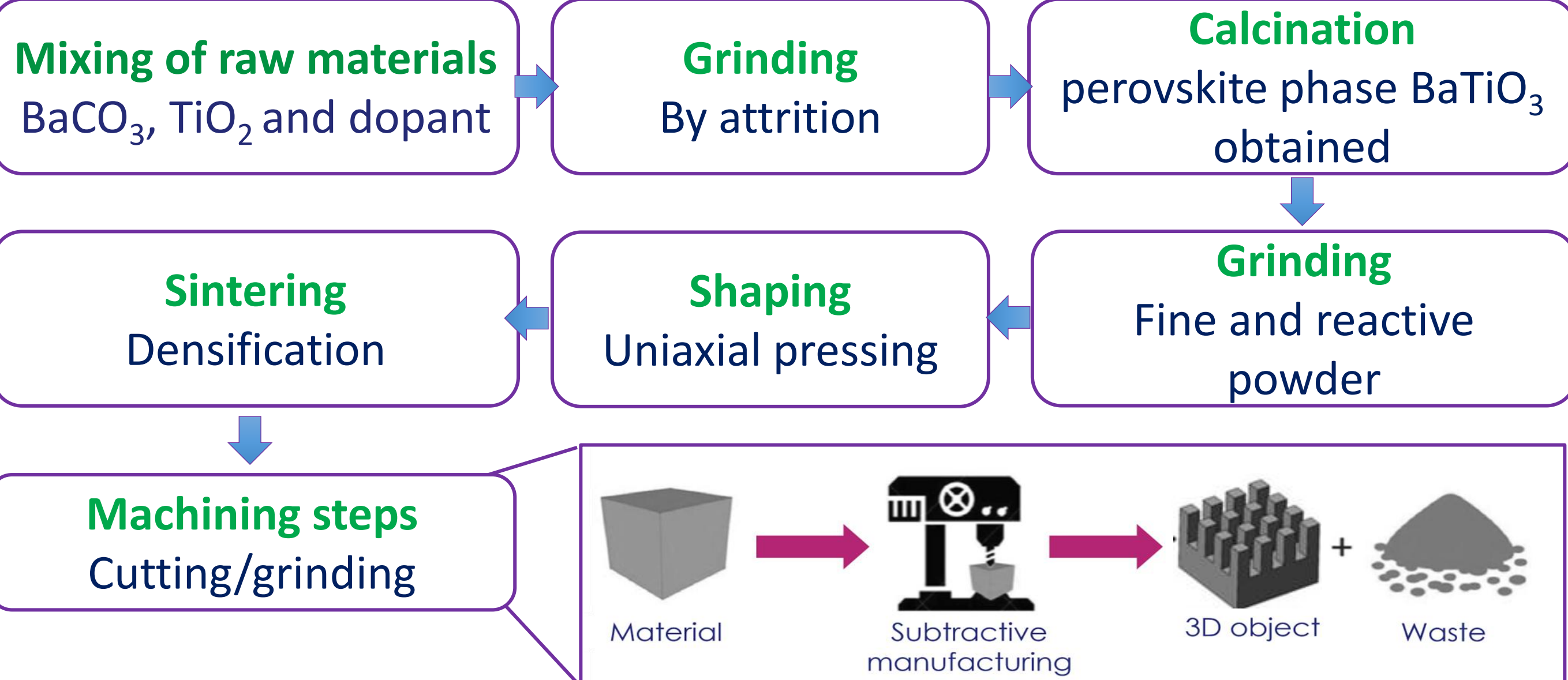

→ Ceramic brittleness
→ Wastages near 80% for underwater devices

Lead-free piezoelectric ceramics

Use of a doped (Nb, Co, Ca) BaTiO₃ developed by Thales R&T

Comparison of the dielectric and piezoelectric properties for an undoped and doped pressed BaTiO₃ [1]

	BaTiO ₃	Doped-BT
Dielectric losses (%)	2,8	0,3
Piezoelectric constant d ₃₃ (pC/N)	145	255
Relative permittivity	2415	1862
Curie temperature (°C)	~ 126	~ 110°C

Microstructure

Thermal treatments and parts densities

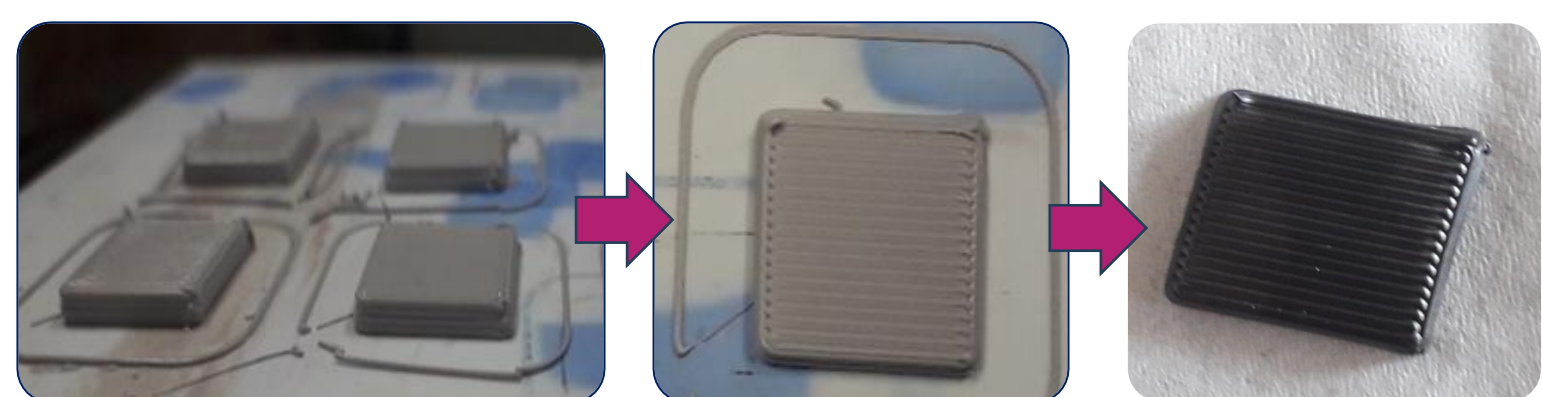

Drying :
40°C - 15h
1°C/mn

Debinding :
600°C - 4h
1°C/mn

Sintering :
1100°C - 4h
3°C/mn

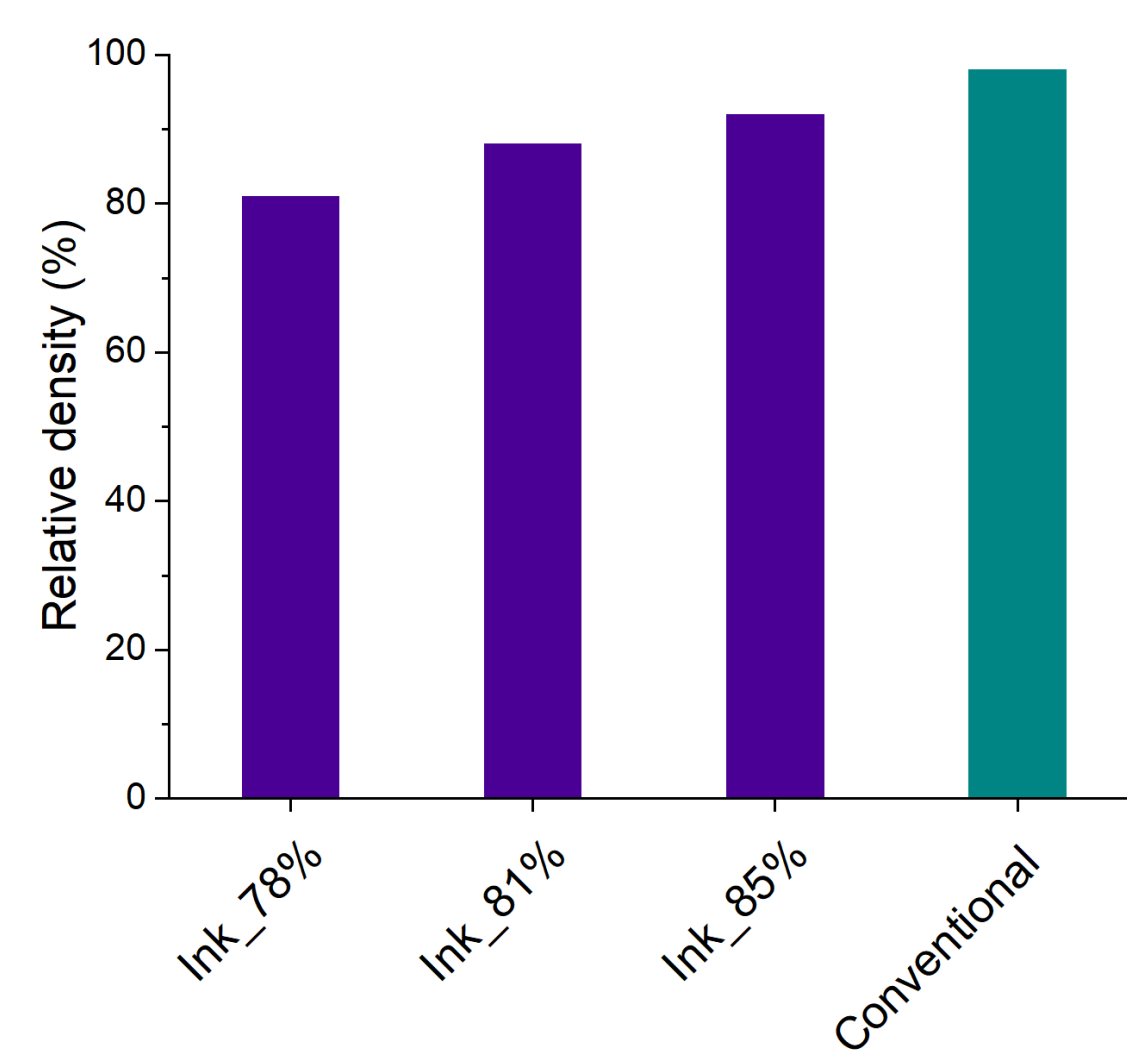

SEM images of the printed parts

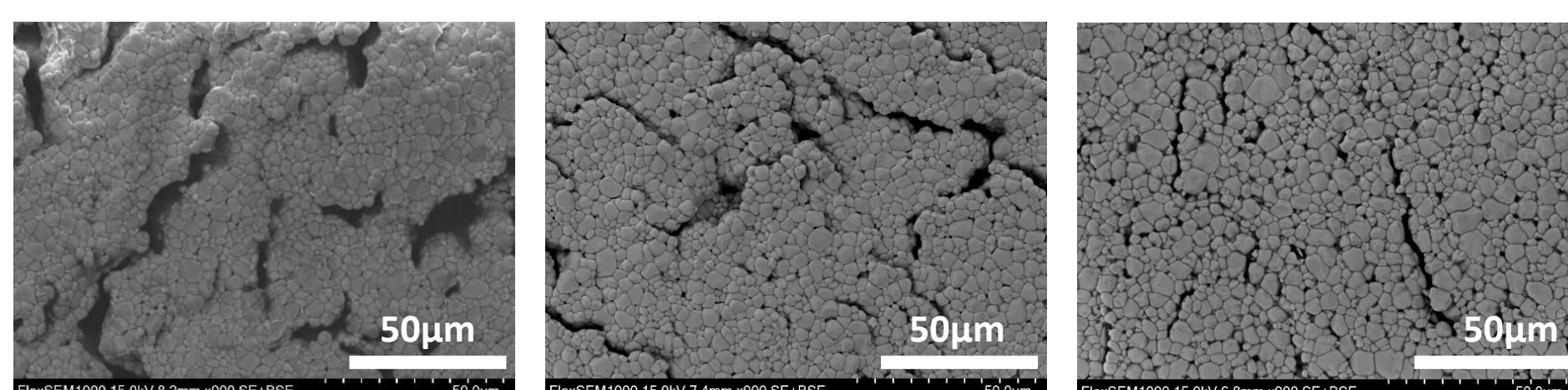

78% 81% 85%

Ceramic filling rate in ink formulation

Grain size ranging from 1 to 12µm

Enhancement of the densification with the increase of ceramic filling rate

Additive manufacturing

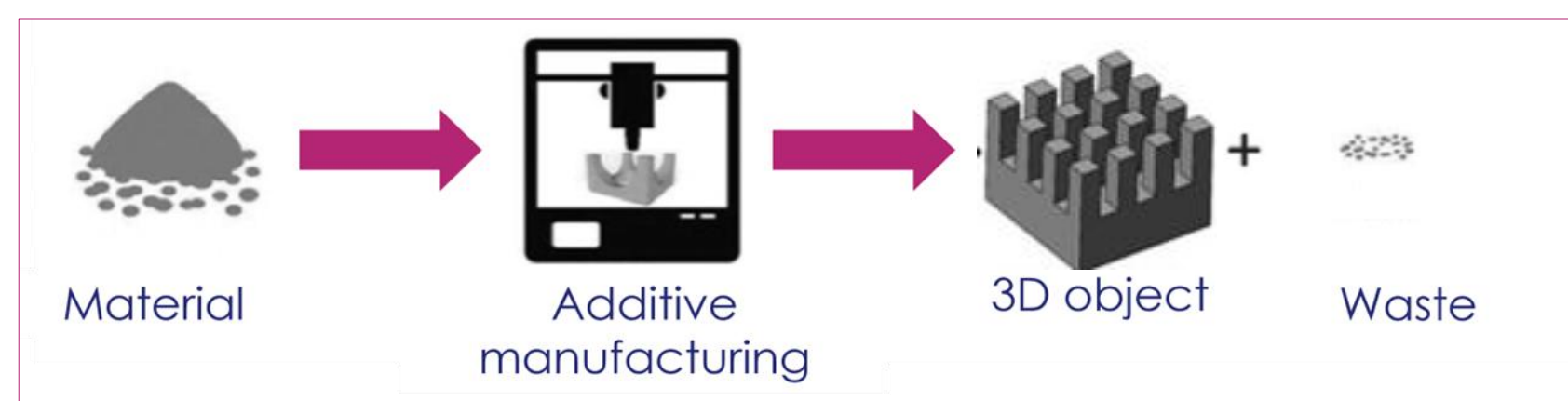

→ Design freedom and flexibility
→ Less material wastages

Ceramic paste formulation

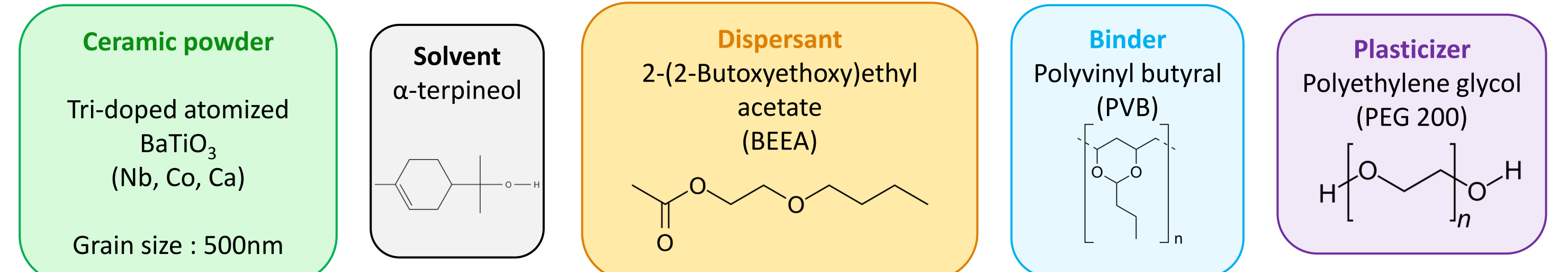

3D-printing by Direct Ink Writing

Printing parameters

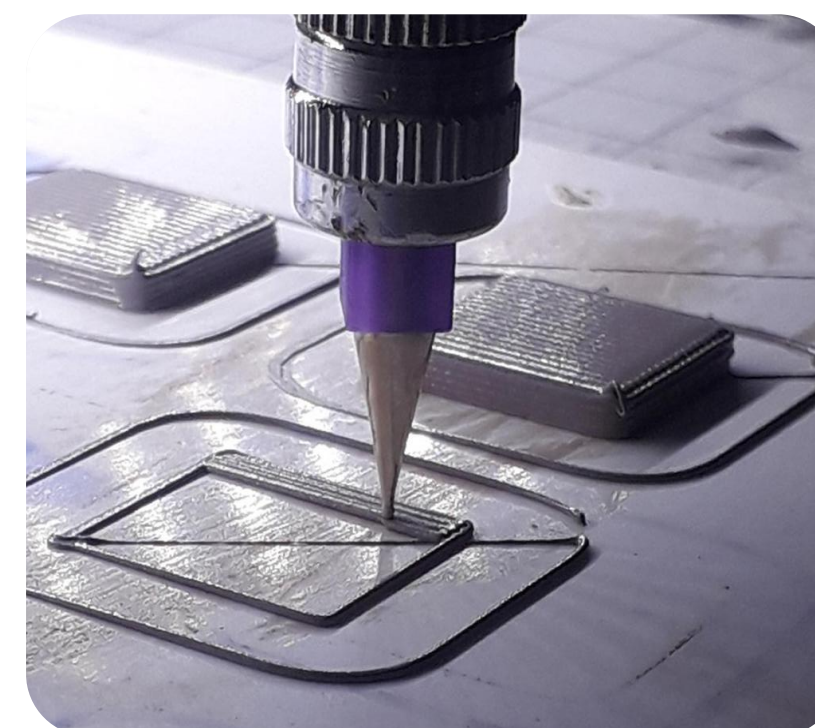

Printing of ceramic parts with 85% of filling rate

Ceramic filling rate : 78 – 81 – 85 %

Rectilinear filling

Cross hatching angle : 90°

Filaments overlapping : 10%

Printing speed : 3 mm.s⁻¹

Nozzle diameter : 0,5 mm



Unoptimized



Optimized

Functional properties

Perovskite structure with a tetragonal crystal system

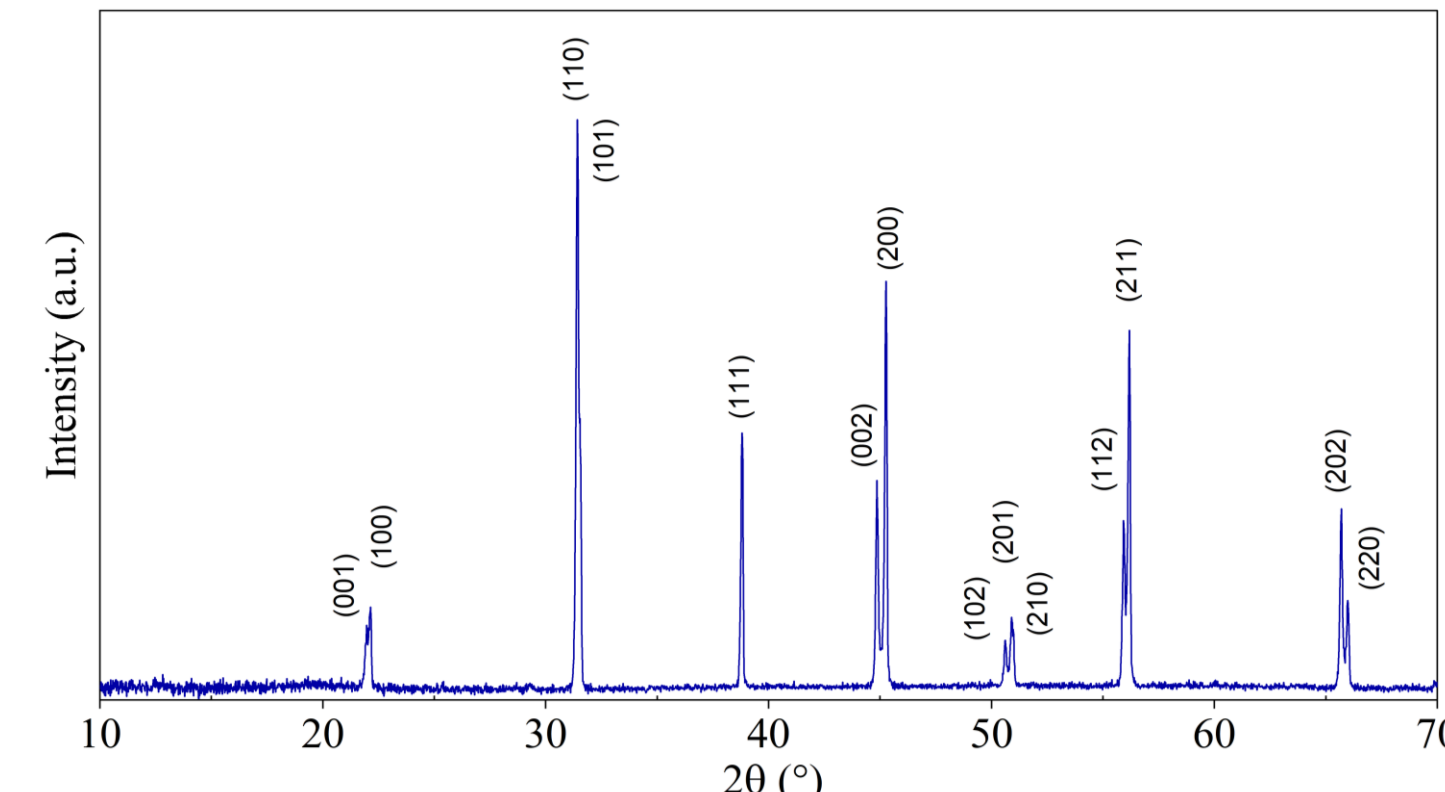

X-ray diffraction pattern of a 3D-printed (Nb, Co, Ca) BaTiO₃

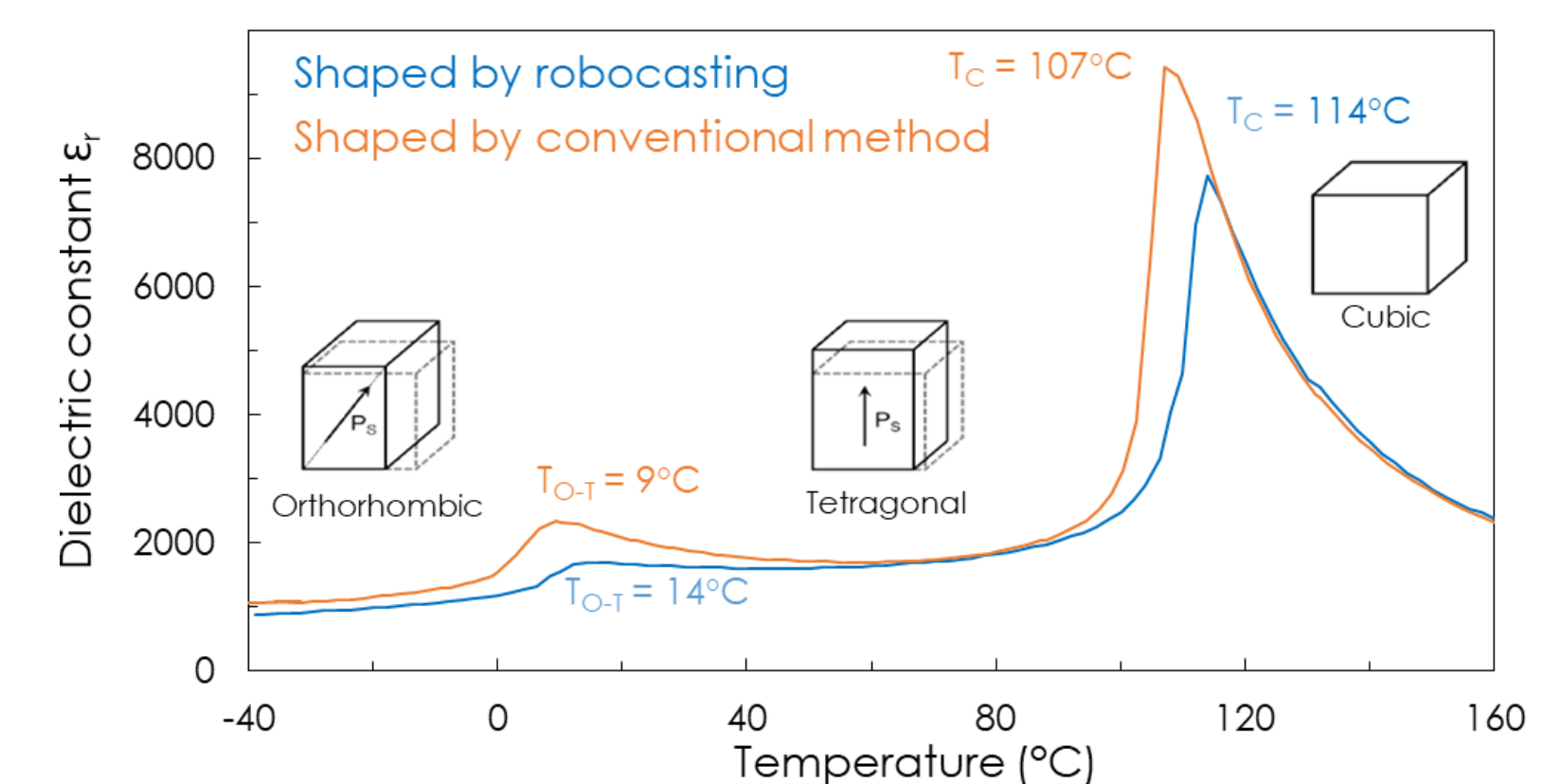

Relative dielectric constant variation under temperature [2]

Poling by field cooling method

Cooling from T^o_{initial} > T_{curie}

Electric field applied : 10 kV.cm⁻¹

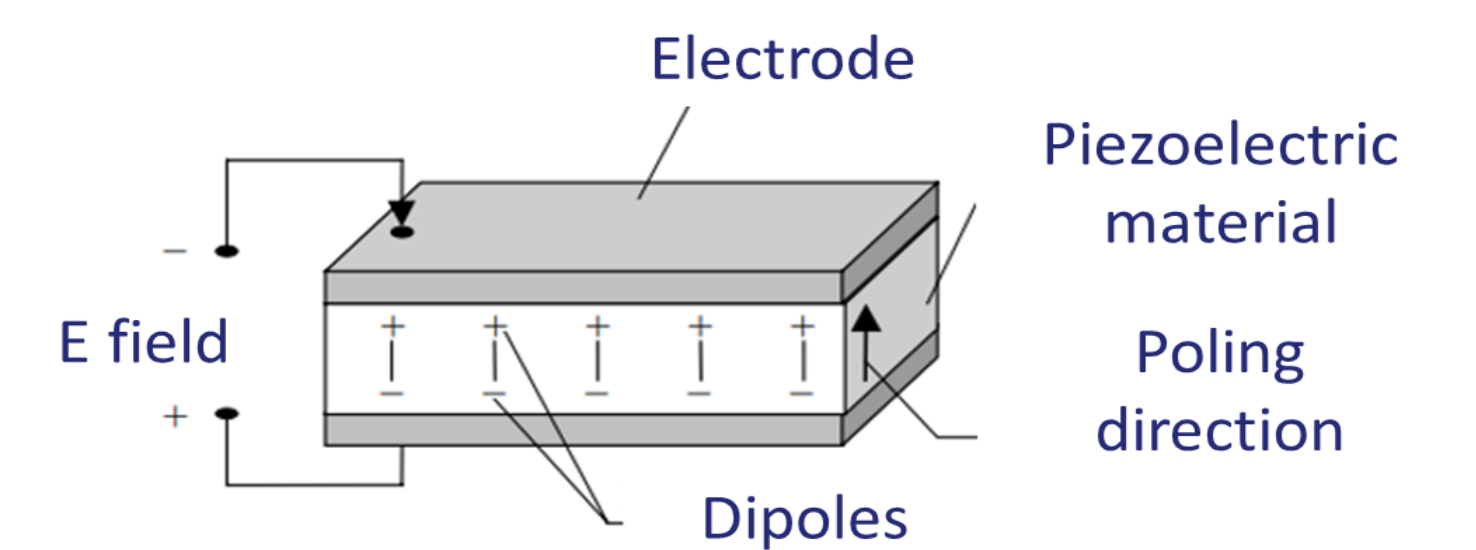

Dielectric and piezoelectric properties

	ε _r	tanδ (%)	d ₃₃ (pC.N ⁻¹)	k _t (%)
Ink_78%	1506	1,32	242	20
Ink_81%	1571	0,75	251	18
Ink_85%	1714	0,52	252	22
Conventional ceramic	1862	0,34	255	47
PZT (NAVY I) ^[3]	1275	0,75	290	-

Conclusion and prospects

Successful shaping of simple geometries
Well densified ceramics that provide good piezoelectric properties (A85%)

Work in progress for the printing of complex geometries such as 1-3 piezocomposites
Elaboration of a water-based ink



References

- R. Ul, « Céramiques piézoélectriques : le titanate de baryum dopé pour transducteurs acoustiques », Thèse de doctorat, Bourges, INSA Centre Val de Loire, 2018.
- R. Damamme, L. Seveyrat, B.-B. Ana, V.-C. Nguyen, M.-Q. Le, P.-J. Cottinet, « 3D Printing of Doped Barium-titanate Using Robocasting - Toward New Generation Lead-free Piezoceramic Transducers », Journal of the European Ceramic Society, vol. 43, Febr. 2023, doi: 10.1016/j.jeurceramsoc.2023.02.054
- « Piezoelectric Materials | Piezo Material | APC International ». <https://www.americanpiezo.com/apc-materials/piezoelectric-properties.html>.