



HAL
open science

Design and Characterization of an Optical 4H-SiC Bipolar Junction Transistor

Pierre Brosselard, Dominique Planson, Dominique Tournier, Pascal Bevilacqua, Camille Sonnevile, Luong Viêt Phung, Mihai Lazar, Bertrand Vergne, Sigo Scharnholz, Hervé Morel

► **To cite this version:**

Pierre Brosselard, Dominique Planson, Dominique Tournier, Pascal Bevilacqua, Camille Sonnevile, et al.. Design and Characterization of an Optical 4H-SiC Bipolar Junction Transistor. Solid State Phenomena, 2024, 360, pp.127-131. 10.4028/p-sj87Lx . hal-04677726

HAL Id: hal-04677726

<https://hal.science/hal-04677726v1>

Submitted on 26 Aug 2024

HAL is a multi-disciplinary open access archive for the deposit and dissemination of scientific research documents, whether they are published or not. The documents may come from teaching and research institutions in France or abroad, or from public or private research centers.

L'archive ouverte pluridisciplinaire **HAL**, est destinée au dépôt et à la diffusion de documents scientifiques de niveau recherche, publiés ou non, émanant des établissements d'enseignement et de recherche français ou étrangers, des laboratoires publics ou privés.

Design and Characterization of an Optical 4H-SiC Bipolar Junction Transistor

P. Brosselard^{1, a *}, D. Planson^{1, b}, D. Tournier^{1, c}, P. Bevilacqua^{1, d}, C. Sonnevile^{1, e}, L.V. Phung^{1, f}, M. Lazar^{2, g}, B. Vergne^{3, h}, S. Scharnholz^{3, i} and H. Morel^{1, j}

¹Univ Lyon, INSA Lyon, Univ. Claude Bernard Lyon 1, Ecole Centrale Lyon, CNRS, Ampère, F-69621, France

²Nanomaterials, Nanotechnologies, L2N, EMR CNRS7004, Université de Technologie de Troyes, 10300, Troyes, France

³ISL, French–German Research Institute of Saint Louis, 5 rue Général Cassagnou, 68301 Saint Louis, France

^apierre.brosselard@insa-lyon.fr, ^bdominique.planson@insa-lyon.fr, ^cdominique.tournier@insa-lyon.fr, ^dpascal.bevilacqua@insa-lyon.fr, ^ecamille.sonneville@insa-lyon.fr, ^fluong-viet.phung@insa-lyon.fr, ^gmihai.lazar@utt.fr, ^hbertrand.bergne@isl.eu, ⁱsiggo.scharnholz@isl.eu, ^jherve.morel@insa-lyon.fr

*corresponding author

Keywords: 4H-SiC, Bipolar Junction Transistor, Optical Triggering

Abstract. In this paper, a first demonstration of the optical triggering of a 10 kV 4H-SiC Bipolar Junction Transistor is reported. A laser emitting UV (349 nm) has been used for the generation electron-hole pairs within the device. A current density of about 20 A.cm⁻² has been obtained. This low value in comparison with 100 A.cm⁻² for “conventional” BJT is due to the narrow pulse width (5 ns). The current waveform shows the effect of the carrier lifetime in the base and collector regions. From these measurements, we have extracted the I_C (V_{CE}) characteristics for different laser optical power and the switch-on time which is about 1 μs.

Introduction

SiC bipolar transistors and thyristors have shown to have promising performances [1]-[2]. Their applications include but are not limited to Flexible AC Transmission Systems (FACTS), High-Voltage Direct Current (HVDC) and wind power [3]. 4H-SiC is also well known to the development of High Voltage devices [4]. At high voltage, it is very interesting to rely on an optical transmission for the control of the device. One way to achieve that is to combine an optical-triggered transistor with an optical emitter for the control of the former. In this paper, the turn-on of an optical controlled 4H-SiC Bipolar Junction Transistor is reported. After a short presentation about the layout and design of the manufactured device followed by a description of the experimental setup, results and analyses of our first characterization of the switch-on BJT will be discussed. Perspectives will then be proposed at the end of the paper.

Structure

The 4H-SiC BJT have been designed and characterized at Ampere Lab and fabricated at L2N. The BJT were designed to withstand a voltage of 10 kV and were fabricated on a 4H-SiC wafer using a 120 μm thick epilayer with a doping concentration of 8×10¹⁴ cm⁻³ (Fig. 1). Eleven photolithographic levels have been processed during the fabrication of the NPN BJT as described in [5]. There is no contact and metal on the base fingers as the latter will behave as optical windows in the optically-

triggered BJT. The optical BJT layout is shown in Fig. 2. The die area is 2.1 mm^2 . Electrical BJTs have also been implemented thanks to the same mask set. metal on fingers and pad base have been deposited. They have the same geometrical parameters (finger length, die area, emitter and base width).

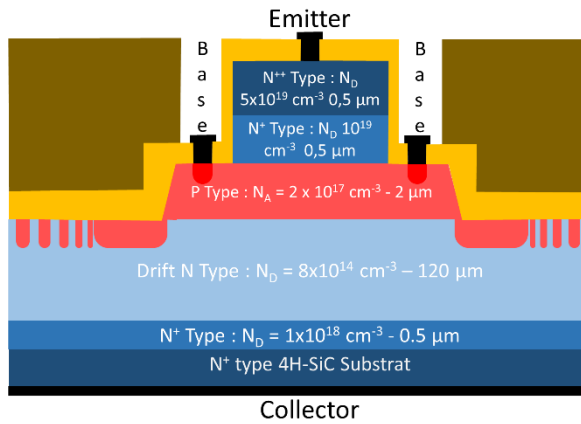
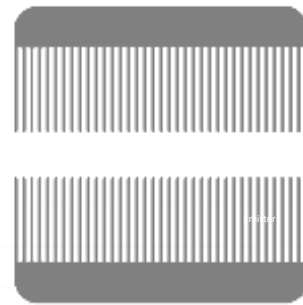

Fig.1. Cross-section of the studied 4H-SiC 10 kV BJT



20 μm without P⁺ and Metal on PAD Base

Fig. 2. Picture of a selected optical BJT with key parameters (Base and Emitter length)

After electrical characterization, we obtain a breakdown voltage of about 11 kV [5]. For the optical structures, there is no contact and metal on the base fingers.

Experimental Setup

A pulsed (5 ns) UV laser emitting at 349 nm is used to generate electron-hole pairs within the SiC material. The frequency of the laser pulse is 1 kHz. To be in the same order of magnitude of the die size, we need to enlarge the laser beam. A diameter of about 2.4 mm is obtained using a beam expander. Fig. 3 presents the electrical circuit used to characterize the BJT and Fig. 4 the photo of the test-bench. Actually, we have fixed the R_{Load} at 4.7Ω (TO220 device). R_{Load} limits the maximum current through the Device Under Test (DUT). R_{Shunt} is used as a sensor for the current measure (Coaxial Device with the red label). Its value is $25.64 \text{ m}\Omega$. Its main advantage is to mitigate parasitic inductors. Since the laser pulse duration is only 5 ns, we do not have a circuit with high parasitic inductors. The role of the electrolytic capacitor C_1 (blue device) is to stabilize the input voltage when the BJT switches on. For C_2 , it is the same role but at high frequency. The range of the Input Voltage, V_{IN} is from 1V to 40V. A MDO3024 Tektronix oscilloscope is used for the testbench. A differential voltage probe (ref. TDP0500) has been operated for DUT voltage drop (V_{CE}) measurements and a 150 MHz passive voltage probe for V_{IN} . In the next part, the experimental results will be detailed and discussed.

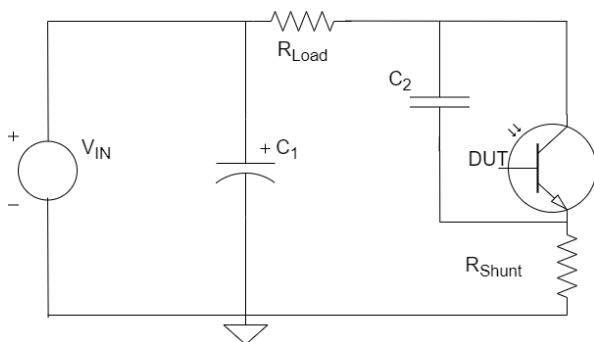

Fig. 3. Electrical schema of the testbench to switch-on the 4H-SiC BJT

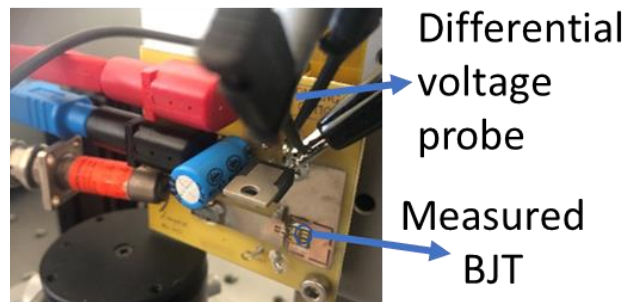

Fig. 4. Photo of the Testbench. Transistor are in the lower right corner

Results and Analysis

The first verification that must be checked is the variation of V_{IN} . In Fig. 5, V_{IN} is on CH2. A small damped oscillation can be observed with a frequency of about 125 MHz. The peak maximum is 1 V and is equal to 5% of the variation. We observe another oscillation on V_{CE} at higher frequency (312,5 MHz). These oscillations may come from the small parasite inductance of the PCB. In Fig. 6, we observe that we have I_C and V_{CE} peaks. This is probably due to a capacitive current coming from the dV/dt applied to the transistor. After that, the decrease of the voltage corresponding to the increase of the current can be observed.

Fig.7 illustrates the global waveforms for V_{IN} and V_{CE} , and I_C . The decrease of the current depends on the carrier lifetime of electrons in the collector region and the carrier lifetime of holes in the base region. The extracted carrier lifetime is about 5 μs . This value is in agreement with the work developed by T. Kimoto in Japan [6]. Due to the narrow laser pulse width, the maximum current looks like a peak. We should then focus our interest in increasing the optical pulse width to see whether or not the current peak still increases at a given laser power. The pulse width is probably too short to obtain the maximum of current capacity of the transistor. With the same wafers and technological process, we have implemented “conventional” electrical BJT. With the same area and same design of the emitter and base fingers, the current level is about 2A corresponding to a current density of 100 $A.cm^{-2}$ [5].

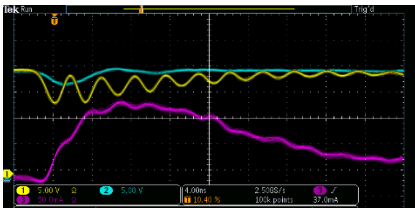

Fig. 5. Waveform of V_{CE} (CH1-yellow), V_{IN} (CH2 -blue) and I_C (CH3 - purple) 4 ns per division $V_{IN} = 20V$ at 120 mW for laser power

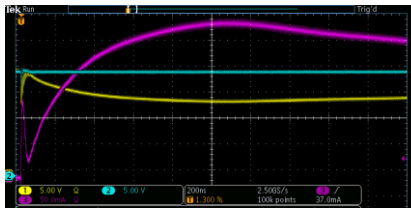

Fig. 6. Waveform of V_{CE} (CH1), V_{IN} (CH2) and I_C (CH3) 200 ns per division $V_{IN} = 20V$ at 120 mW for laser power

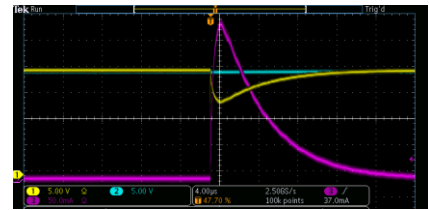

Fig. 7. Waveform of V_{CE} (CH1), V_{IN} (CH2) and I_C (CH3) 4 μs per division $V_{IN} = 20V$ at 120 mW for laser power

From this current peak, V_{CE} and the time have been extracted. Measurements have been performed in a large V_{IN} range (from 1V up to 30V) for six different laser powers. At its lowest power (<16 mW), the transistor does not switch-on. This is probably due to an insufficient light absorption producing a too low generation of holes in the base. Fig. 8 exhibits I_C versus V_{CE} for different laser powers. These characteristics are similar to a “conventional” BJT. The current density of the optical devices (20 $A.cm^{-2}$) is lower than the “conventional” BJT [5] as a current density of 100 $A.cm^{-2}$ is recorded, the difference is probably due to the narrow pulse width as previously discussed. These results are of some interest because a demonstration has been done for the switch-on of a 10 kV 4H-SiC BJT. We can also observe that the current decreases for the measures at higher V_{CE} values for different laser power. Classically, this is due to the increase of the temperature but in this case the current density is very low so, this is probably due to the recombination of the carriers in the base region of the BJT.

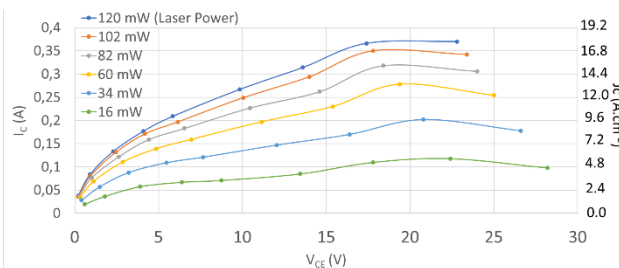

Fig. 8. I_C versus V_{CE} computed for different laser power from 16 mW to 120 mW

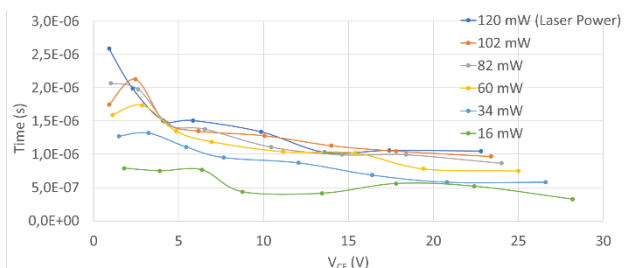

Fig. 9. Switch-on time versus V_{CE} for different laser power from 16 mW to 120 mW

Switch-on times have been also extracted. These values have been obtained when the current is maximum. Fig. 9 illustrates the switch-on time versus V_{CE} for different laser powers. These curves show that switch-on time tends to decrease with the V_{CE} increase. This is likely due to the increase of the space charge region width around the Base/Collector junction accelerating the circulation of the electron-hole pairs. The second tendency, we can observe is the decrease of the switch-on time with laser power. The diameter of the spot is larger than the active area of the device. The metallization of the Emitter fingers decreases the effect of the laser. In the base, the lateral diffusion of the hole due to electron-hole generation is not optimized for a low laser power. At higher laser power, the lateral diffusion increases so the time to switch-on the transistor decreases with the increase of the laser power.

The result and analysis have been focused on only one transistor design. For this one, there is no metal on the pad and finger Base. The results obtained for the other layout are very similar. Due to the narrow laser pulse width, we think that a conclusion about the layout cannot be drawn.

Summary

From this study, we have demonstrated for the first time the optical triggering of a 10 kV 4H-SiC Bipolar Junction Transistor. The current density is lower than a “conventional” BJT with an electrical control on the base. This is probably due to the narrow pulse width that does not generate enough electron-hole pairs. This setup could be improved using a lens to focus the laser spot on the die, the idea being to optimize the laser surface power density to switch-on the BJT. Another method using UV-LED to generate optically electron-hole pairs could be investigated too. UV-LED source could probably increase the pulse width of the electron-hole pairs generation and improve the collector current density of the device thus increasing the pulse length.

References

- [1] S. K. Mazumder, A. Mojab and H. Riazmontazer, "Optically-switched wide-bandgap power semiconductor devices and device-transition control" in *Physics of Semiconductor Devices*, New York:Springer International Publishing, pp. 57-65, 2014.
- [2] N. Dheilly, G. Pâques, S. Scharnholz, D. Planson, "Pulse characterization of optically triggered SiC thyristors", *Materials Science Forum Vols. 717-720 (2012)* pp 1179-1182. doi:10.4028/www.scientific.net/MSF.717-720.1179
- [3] A. Mojab, H. Riazmontazer, A. Meyer, S. K. Mazumder, M. Zefran, "Low-leakage drive for optically-triggered high-power SiC emitter turn-off thyristors", *2015 IEEE Power and Energy Conference at Illinois (PECI)*, Champaign, IL, USA, 2015, pp. 1-5, doi: 10.1109/PECI.2015.7064919
- [4] T. Kimoto, “High-voltage SiC power devices for improved energy efficiency”, *Proceedings of the Japan Academy, Series B, Vol. 98, N°4*, p. 161-189, 2022
- [5] A. Ammar, M. Lazar, B. Vergne, S. Scharnholz, L. V. Phung, P. Brosselard, D. Tournier, C. Sonneville, C. Raynaud, M. Zielinski, H. Morel and D. Planson, *Design, Fabrication and Characterization of 10kV 4H-SiC BJT for the Phototransistor Target*, *Romanian Journal of Information Science and Technology*, Vol.26, Number 2, 2023, 193-204
- [6] T. Kimoto, High-voltage SiC power devices for improved energy efficiency, *Proceedings of Japan Academy, Series B*, 98 4 p. 161-189, 2022, <https://doi.org/10.2183/pjab.98.011>