



HAL
open science

Visualization of P+ JTE embedded rings used for peripheral protection of high voltage Schottky diodes by the Optical Beam Induced Current (OBIC) technique

Dominique Planson, Dominique Tournier, Pascal Bevilacqua, Camille Sonnevile, Pierre Brosselard, Gabrielle Moulin, Luong Viêt Phung, Philippe Godignon

► To cite this version:

Dominique Planson, Dominique Tournier, Pascal Bevilacqua, Camille Sonnevile, Pierre Brosselard, et al.. Visualization of P+ JTE embedded rings used for peripheral protection of high voltage Schottky diodes by the Optical Beam Induced Current (OBIC) technique. *Solid State Phenomena*, 2024, 360, pp.119-125. 10.4028/p-d65YuN . hal-04677706

HAL Id: hal-04677706

<https://hal.science/hal-04677706v1>

Submitted on 26 Aug 2024

HAL is a multi-disciplinary open access archive for the deposit and dissemination of scientific research documents, whether they are published or not. The documents may come from teaching and research institutions in France or abroad, or from public or private research centers.

L'archive ouverte pluridisciplinaire **HAL**, est destinée au dépôt et à la diffusion de documents scientifiques de niveau recherche, publiés ou non, émanant des établissements d'enseignement et de recherche français ou étrangers, des laboratoires publics ou privés.



Distributed under a Creative Commons Attribution 4.0 International License

Visualization of P⁺ JTE Embedded Rings Used for Peripheral Protection of High Voltage Schottky Diodes by the Optical Beam Induced Current (OBIC) Technique

Dominique Planson^{1,a*}, Dominique Tournier^{1,b}, Pascal Bevilacqua^{1,c},
Camille Sonnevile^{1,d}, Pierre Brosselard^{1,e}, Gabrielle Moulin^{1,f},
Luong Viet Phung^{1,g} and Philippe Godignon^{2,3,h}

¹Univ Lyon, INSA Lyon, Univ. Claude Bernard Lyon 1, Ecole Centrale Lyon, CNRS, Ampère, F-69621, France

²IMB-CNM-CSIC, Campus UAB, 08193 Bellaterra, Barcelona, Spain

³CEA-Leti, Univ. Grenoble Alpes, F-38000 Grenoble, France

^adominique.planson@insa-lyon.fr, ^bdominique.tournier@insa-lyon.fr,

^cpascal.bevilacqua@insa-lyon.fr, ^dcamille.sonneville@insa-lyon.fr, ^epierre.brosselard@insa-lyon.fr,
^fgabrielle.moulin@insa-lyon.fr, ^gluong-viet.phung@insa-lyon.fr, ^hphilippe.godignon@cea.fr,
^hphilippe.godignon@cnm.es

*corresponding author

Keywords: 4H-SiC Schottky diode, high voltage device, electro-physical characterisation, periphery protection, OBIC.

Abstract. This paper presents micro-OBIC measurements performed at different biasing on two power devices protected by a combination of P⁺ rings embedded in a JTE Zone. Thanks to the micro-OBIC micrometer spatial resolution, small gaps can be visible on OBIC profiles. Thus, the spatial variation of the micro-OBIC signal accurately reflects the topology of the periphery protection: combination of JTE and rings and channel stopper. These measurements agree with the electric field distribution (calculated by finite element method) along the structure.

Introduction

In order to take full advantage of the benefits offered by Silicon Carbide (SiC) and to avoid premature breakdown (previous to avalanche) of high voltage devices, it is mandatory to have efficient edge termination such as MESA, JTE, field rings, rings assisted JTE, embedded rings into a JTE or a combination of all these single termination as described by Godignon in [1]. The designer has an almost unlimited choice, as long as he respects the constraints of technological manufacturing. To determine the precise dimensions of the multiple geometrical and process parameters, he can effectively rely on Technology Computer-Aided Design (TCAD), by examining the distribution of the electric field in the semiconductor. However, this requires an enormous amount of computing time.

The Optical Beam induced Current (OBIC) is a non-destructive characterization technique, which has been previously used to characterize High Voltage (HV) Si and SiC devices [2, 3, 4]. When applying a focused UV laser beam into a biased Silicon Carbide device, electron-hole pairs can be generated. Within the space charge region, the electric field drives the collected carriers and a resulting current, called Optical Beam induced Current (OBIC), can be measured. The induced current is directly related to the electrical field in the device. The OBIC characterization can support the technology computer-aided design (TCAD) and the device processing to properly optimize the efficiency of the edge protection by analyzing the electric field distribution in the structure, especially at the junction periphery. In this work, our OBIC test-bench with a micro-meter spatial resolution allowed to characterize the periphery of SiC 1.2kV JBS diodes with a high spatial resolution and compare the results with the electric field distribution calculated from TCAD simulations.

Experimental Setup

A pulsed laser emitting UV at 349 nm is used to generate electron-hole pairs into the SiC. In order to reduce the laser beam spot size, the laser spot is focused by a microscope objective as described in [5, 6]. The diode is fixed on a X,Y,Z motorized stage and it can be moved under the laser beam focus point. Induced current in the reverse biased the DUT is then measured with a Source-Measure Unit (SMU). 1D micro-OBIC scans were performed on two sets of JBS diodes fabricated at CNM on a 4H-SiC wafer using a 12 μm thick epilayer with a doping concentration of $8 \times 10^{15} \text{ cm}^{-3}$. The two diodes (A and B) are protected by two different lengths of JTE with 3 rings implanted inside as shown in Fig. 1. Diode A has a JTE length of 200 μm , and diode B has a JTE length of 100 μm . Rings have 3 μm width and are separated 4.5/5/5.5 μm . Up to now, OBIC spatial resolution was not high enough to observe the rings inside the JTE.

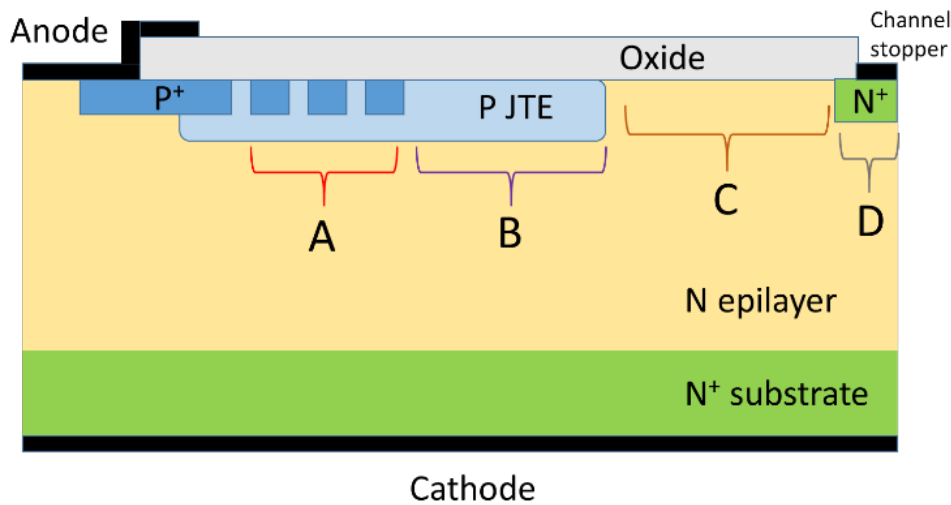

Fig. 1. Cross-section of the periphery protection of the Schottky diode (JTE with implanted rings inside) with channel stopper. 4 zones are defined: A: implanted rings, B: JTE, C: margin and D: channel stopper.

For efficient measurement, selected diodes must exhibit a very small reverse leakage current as shown in Fig. 2.

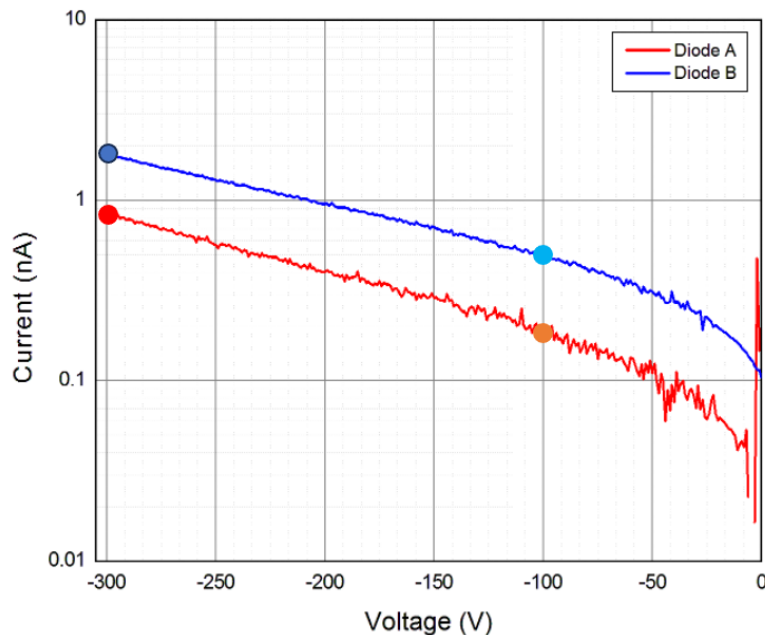

Fig. 2. Reverse currents for both diodes until 300V. Diode A has a JTE length of 200 μm , and diode B has a JTE length of 100 μm . The dots (blue and red) on the figure show the biasing voltages for which OBIC measurements are made.

Results and Analysis

Once the reverse bias voltage has stabilized, the diode can be scanned from the edge of the diode anode towards the periphery. Figure 3 exhibits the OBIC current for different voltages (100V and 300V) for both diode A and B. The impact of the implanted rings in the JTE on the OBIC signal can be now clearly seen (zone A) as well as the JTE length (zone B). The current intensity increases sharply with the applied reverse voltage. In zone C, the OBIC signal decreases slowly probably due to the interface charges between passivation oxide and the SiC. The impact of the channel stopper (zone D) is also observed as the OBIC signal is nearly zero.

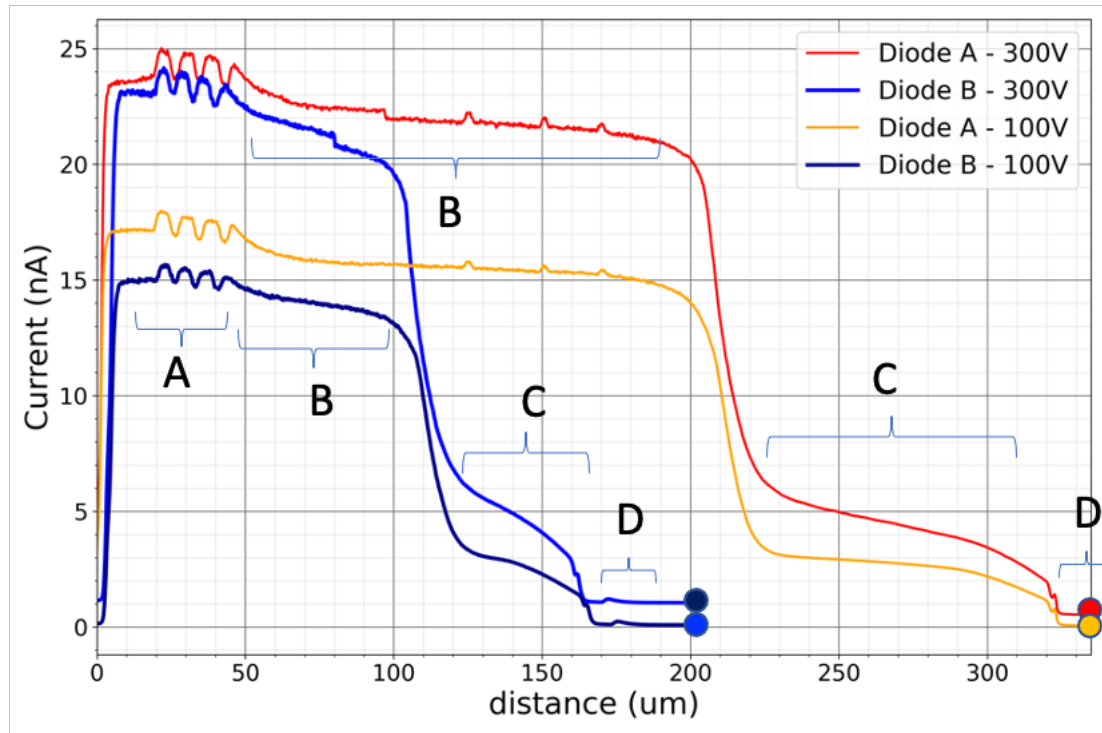

Fig. 3. Micro-OBIC 1D-scans under two biasing voltages for diodes A and B. 4 zones are defined: A: implanted rings, B: JTE, C: margin and D: channel stopper.

For the longest JTE, additional scans have been performed for voltages ranging from 50V up to 300V. As the measurements are performed in air, the reverse voltage is limited. Fig. 4 shows the corresponding scans. In zone A, one can observe 4 peaks which are related to the 3 rings (one peak for each ring and one additional for the P⁺ border inside the JTE). At 300V the highest peak is located in the first inner ring.

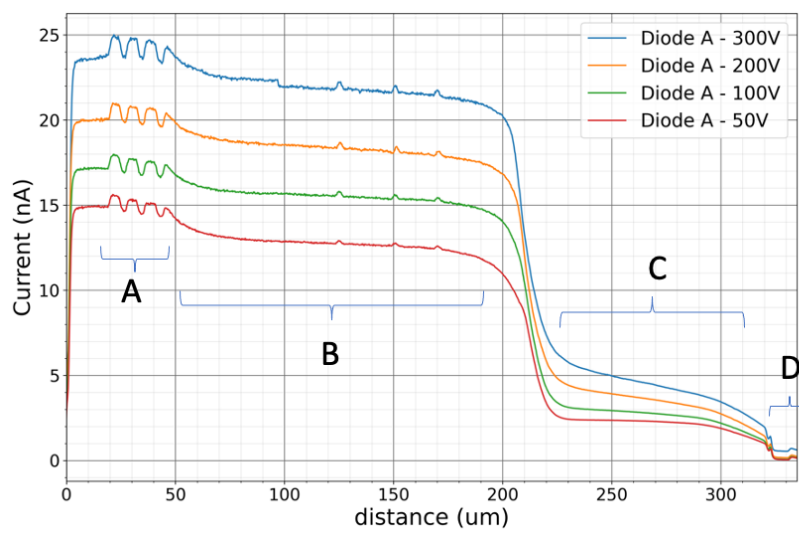

Fig. 4. Micro-OBIC 1D-scans for several voltages for diodes A including the different termination's zones. 4 zones are defined: A: implanted rings, B: JTE, C: margin and D: channel stopper.

To support the idea that simulation is an aid to the design of periphery protection, we have simulated the structure and examined the electric field. TCAD simulation using SynopsysTM [7] have been performed.

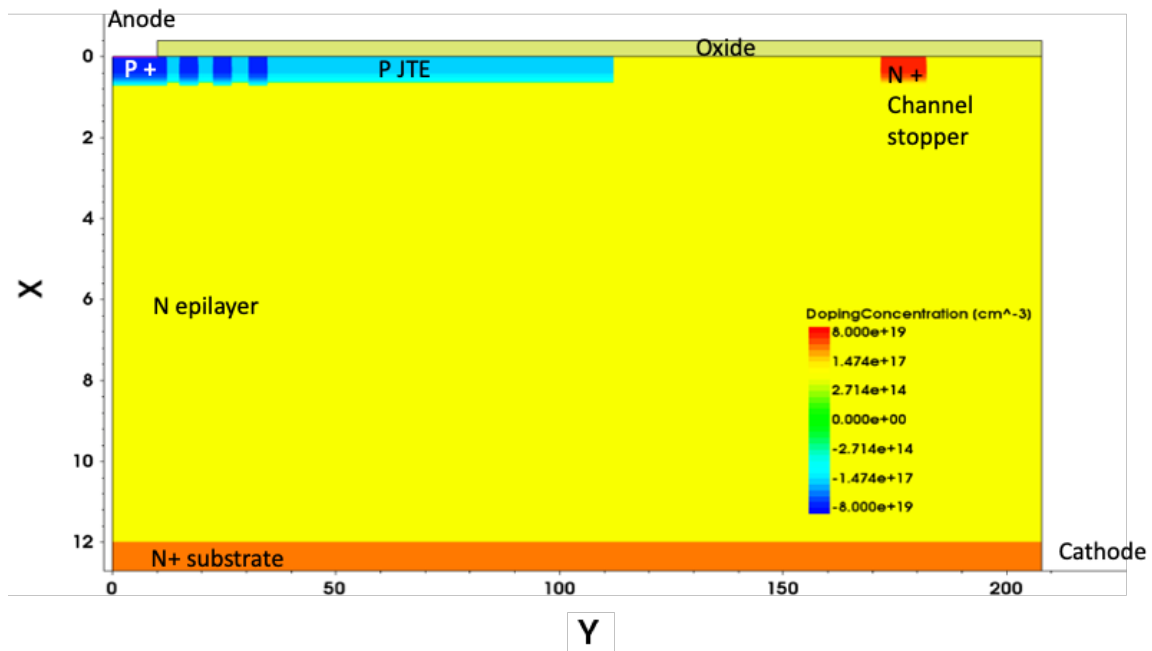

Fig. 5. 2D TCAD diode structure.

Fig. 5 depicts the 2D structure which has been simulated by Synopsys Sentaurus TCAD. The present structure includes all the features of the one shown in Fig.1. Diodes A and B all derive from it by varying the JTE length. Reverse off-state simulations up to 300 V have been performed. To save computing time and memory, the N⁺ substrate has been thinned, as its thickness is will not have a significant impact.

Fig.6 shows the 2D the electric field and the respective isolines computed from TCAD simulations under 50 V, 100 V, 200 V and 300 V. The dimensions of the peripheral termination are from diode A. As the applied voltage is increased, the electric field spreads further into the epitaxial layer. It can be noticed the space charge area depth is about the penetration depth of the laser beam, whose amplitude exponentially decreases. Diode B peripheral termination has also been simulated but, for clarity purpose, will not be shown as similar observations can be made.

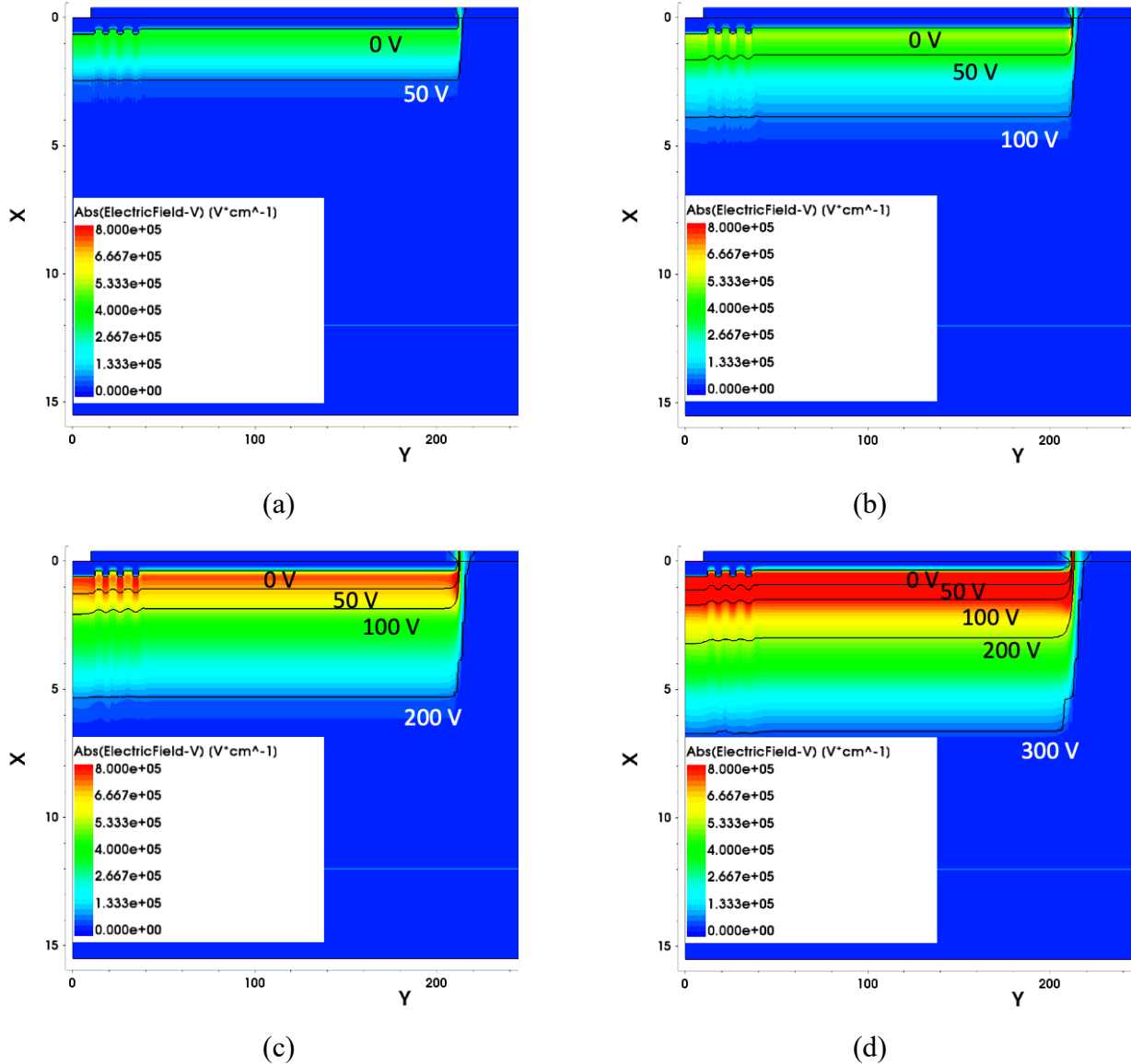

Fig. 6. TCAD Electric Field, and potential isolines of the diode A peripheral protection under several reverse voltages (a): 50 V, (b): 100 V, (c): 200 V and (d): 300 V.

The electric field distribution along the x-axis under a reverse voltage of 200V is presented in Fig. 7a. The impact of the implanted rings is clearly observed in zone A. The JTE length (for diode A and B) is clearly seen in zone B. However, with this electric simulation the electric field remains constant throughout the JTE, and do not show a slow decrease like in the OBIC measurements in Fig. 3 and 4. Interface charges have not been considered for the present simulation. However, even though the charges were included, this would not be enough to explain the difference, as charges alone would mainly cause a shift in the electric field profile. Its decrease along the horizontal axis may be explained by surface leakage currents. Further simulations are then required. The same observation can be made in the C-zone between the edge of the JTE and the channel stopper. Another explanation would be a non-uniform JTE doping profile. This assumption would need to be corroborated with the JTE doping lateral profile characterization. Nonetheless, the electric field profile obtained from TCAD is clearly dependent on the applied voltage as shown in Fig. 7b which show different diode A electric profiles for different voltages. The field amplitude is voltage-dependent, and the same thing can be said for its lateral extension as shown in the inset. Furthermore, the widths of zones B and C which appear in simulations are in line with the experimental results. This corroborates the observations made for Figures 3 and 4.

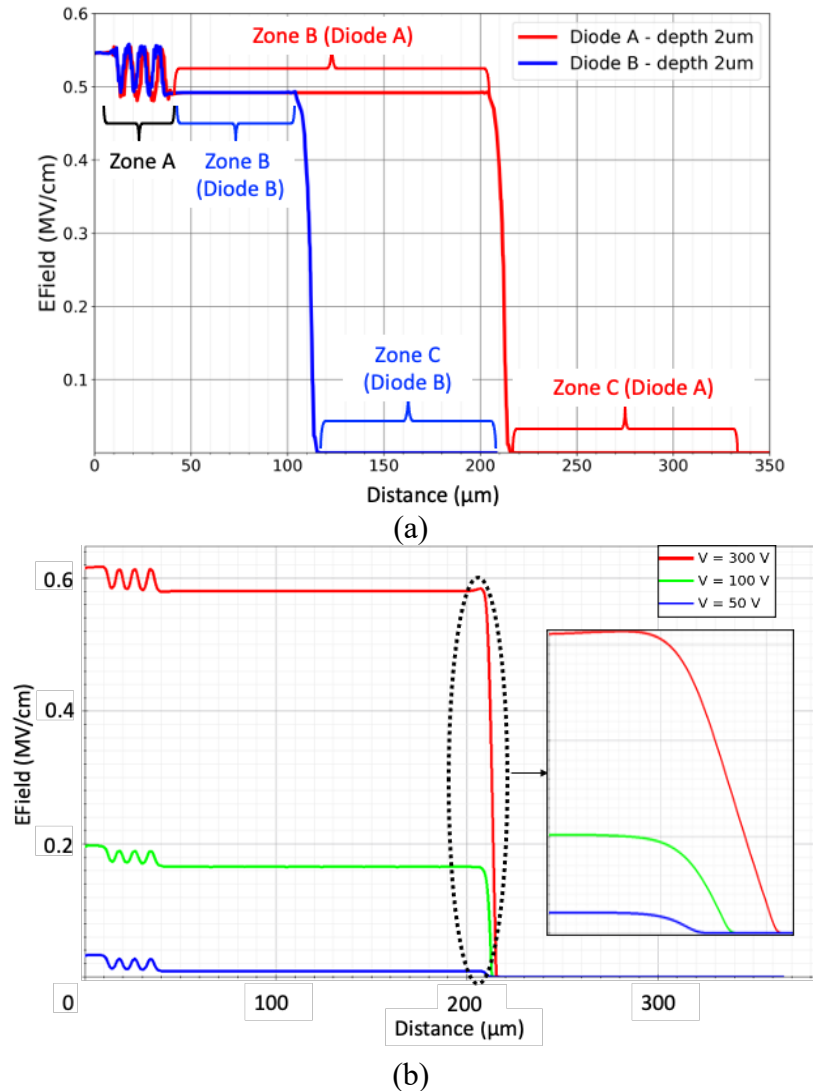

Fig. 7. (a) Electric field distribution along the periphery protection at a given depth of 2 μm at 200 V, (b) Electric field distribution along the diode A periphery protection at a given depth of 2 μm at 50 V, 100 V and 300 V.

Summary

This paper presents OBIC measurements carried out on Schottky diodes protected by a combination of JTE protection and implanted P^+ rings. 2 JTE lengths were defined and 3 rings implanted quite close together. The OBIC measurements show that the good resolution of our test bench is capable of revealing the different zones of the protection and also the impact of the applied reverse voltage. In this particular design, the highest peak is located in the first P^+ ring. TCAD simulations may be used to support the experimental results as there is good agreement between experimental results and simulations with regards to ring and JTE positions and widths. The current simulated structures are still not able to reproduce the same electric field profile as it stays constant within the P JTE region. The explanation may come from the recombination current at the oxide/semiconductor interface that is not simulated. We plan to improve our test bench with measurements in a vacuum chamber, so that we can carry out measurements at higher voltages and close to breakdown voltage.

References

- [1] P. Godignon, J. Montserrat, J. Rebollo, D. Planson (2022), Edge Terminations for 4H-SiC Power Devices: A Critical Issue, *Materials Science Forum* Vol. 1062, pp 570-575
- [2] R. Stengl, High-voltage planar junctions investigated by the OBIC method, (1987), *IEEE Transactions on electron devices*, vol. ED-34, no. 4, pages 911-919
- [3] H. Hamad, D. Planson, C. Raynaud, P. Bevilacqua, OBIC technique applied to wide bandgap semiconductors from 100 K up to 450 K, (2017), *Semicond. Sci. Technol.* 32 (5) 054001
- [4] D. Planson, B. Asllani, L.V. Phung, P. Bevilacqua, H. Hamad, C. Raynaud, (2019), Experimental and simulation results of optical beam induced current technique applied to wide bandgap semiconductors, *Materials Science in Semiconductor Processing* 94, 116-127
- [5] D. Planson, C. Sonnevile, P. Bevilacqua, L.V. Phung, B. Asllani, D. Tournier, P. Brosselard, 4H-SiC PiN diode protected by narrow fields rings investigated by the OBIC method, *Materials Science Forum* Vol. 1062 (2022) pp 341-345
- [6] C. Sonnevile, D. Planson, L. V. Phung, P. Bevilacqua, B. Asllani, Interest of Using a Micro-Meter Spatial Resolution to Study SiC Semi-Conductor Devices by Optical Beam Induced Current (OBIC). *Materials Science Forum*, vol. 1004, Trans Tech Publications, Ltd., July 2020, pp. 290–298
- [7] Sentaurus Device User Guide, Synopsys, Mountain View, CA, USA, 2022. www.synopsys.com