



HAL
open science

Experimental tests of the calibration of high precision differential astrometry for exoplanets

Manon Lizzana, Fabien Malbet, Pierre Kern, Fabrice Pancher, Sébastien Soler, Thierry Lepine, Alain Leger

► To cite this version:

Manon Lizzana, Fabien Malbet, Pierre Kern, Fabrice Pancher, Sébastien Soler, et al.. Experimental tests of the calibration of high precision differential astrometry for exoplanets. *Exoplanets V*, Jun 2024, Leyden, Netherlands. hal-04677656

HAL Id: hal-04677656

<https://hal.science/hal-04677656v1>

Submitted on 26 Aug 2024

HAL is a multi-disciplinary open access archive for the deposit and dissemination of scientific research documents, whether they are published or not. The documents may come from teaching and research institutions in France or abroad, or from public or private research centers.

L'archive ouverte pluridisciplinaire **HAL**, est destinée au dépôt et à la diffusion de documents scientifiques de niveau recherche, publiés ou non, émanant des établissements d'enseignement et de recherche français ou étrangers, des laboratoires publics ou privés.

Experimental tests of the calibration of high precision differential astrometry for exoplanets

Manon Lizzana (1,2,3), Fabien Malbet (1), Pierre Kern (1), Fabrice Pancher (1), Sébastien Soler (1), Thierry Lepine (4), Alain Leger (5)

Scientific objectives :

- investigate the nature of the **dark matter in the Milky way** by studying the modification of star trajectories in the galactic plane
- Study compact objects and particularly X-binaries
- Explore **planetary systems** in the Sun's vicinity and draw up a list of potential targets for future spectroscopic missions (LIFE, HWO)
 - We focus here on **rocky exoplanets in the habitable zone** detection because it's the most demanding aspect

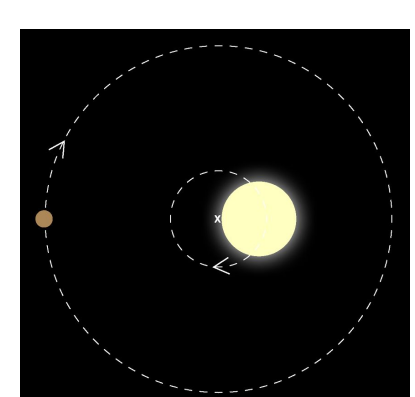

Exoplanets detection by astrometry

see poster 1016 (Fabien Malbet) for more details

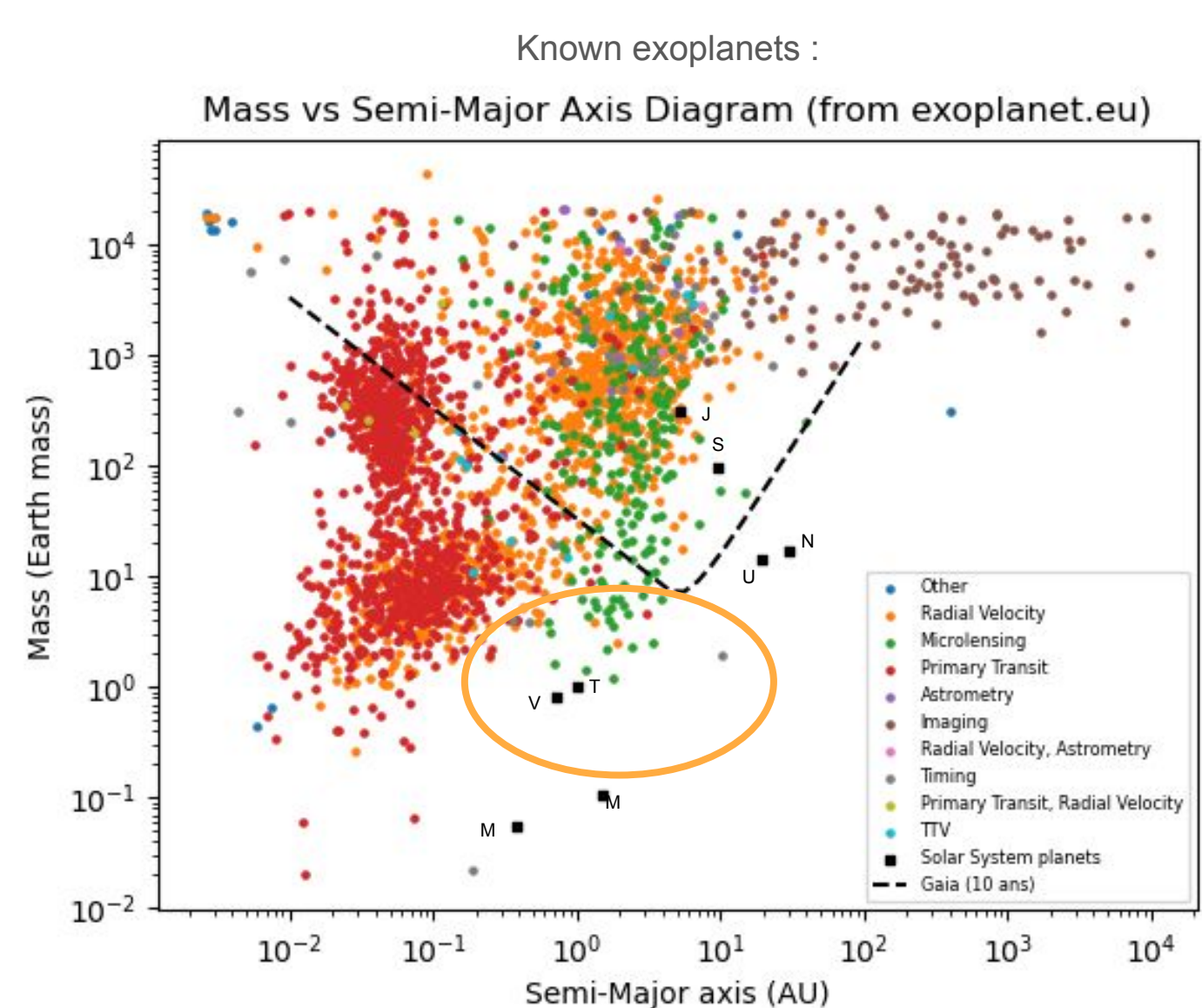

Relevant space missions :

Theia (at the age of Gaia)

HWO

wavelength	400 λ <math>< 900</math> nm	UV, visible et IR
Progress	Project (ESA call M8 - 1 an)	planned launch ~2040
Diameter (D)	0.8m	between 6.5 and 8m
Signal exo-Earth 10pc away \rightarrow 0.3 μ s (pixels 4 μ m)	PSF - $\lambda/D = 140$ mas \leftrightarrow 2 px exo-Earth : 0.3 μ s \leftrightarrow 5e-6 px	PSF - $\lambda/D = 14$ mas \leftrightarrow 2 px exo-Earth : 0.3 μ s \leftrightarrow 5e-5 px
Field of view	30'x30' (0.5°x0.5°) 30 000 x 30 000 px ~ 1 Gpx	2'x3' (wide field imager) TBC 20 000 x 30 000 px ~ 1 Gpx
Dynamic	$m_{target} \sim 6; m_{ref} \leq 14$ \Rightarrow dynamic ~ 1e3	$m_{target} \sim 6; m_{ref} \leq 20$ \Rightarrow dynamic ~ 1e5

Characterize an adequate CMOS detector

Global characterization : linearity, dark current, readout noise, gain, map of defective pixels, ...

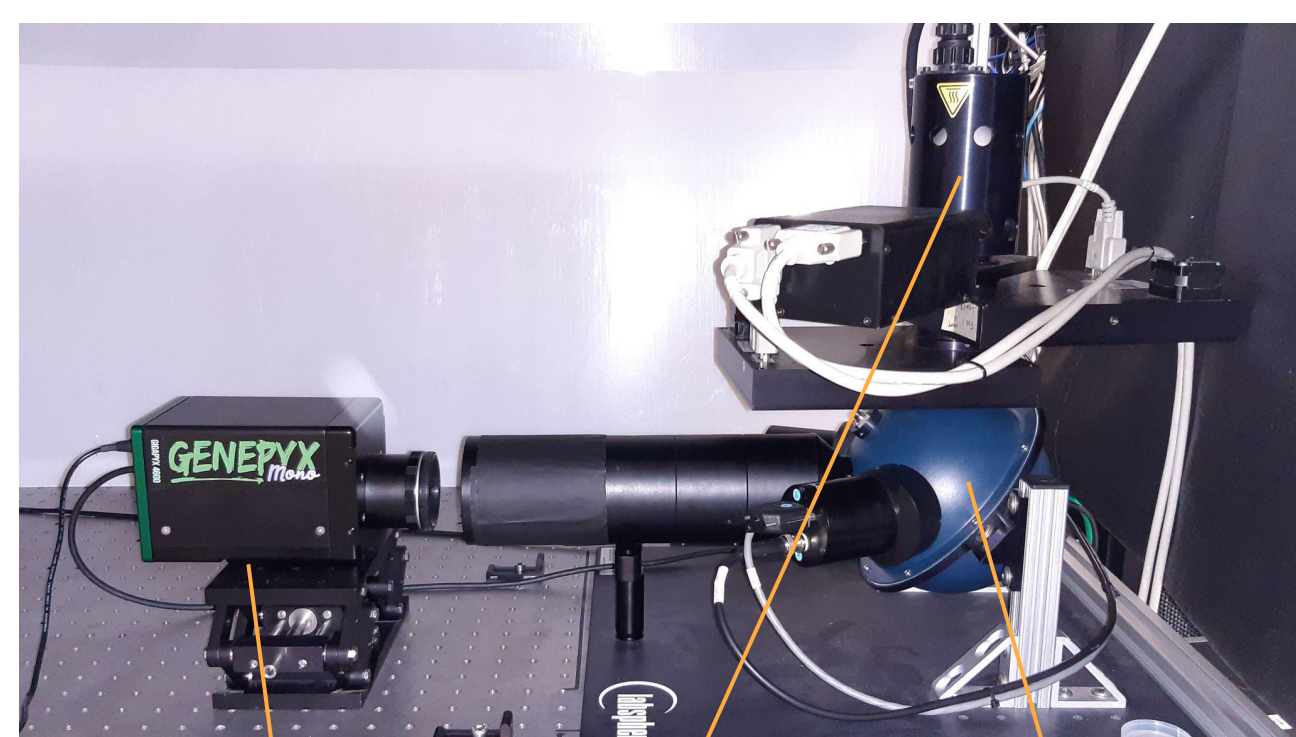

detector Source integrating sphere

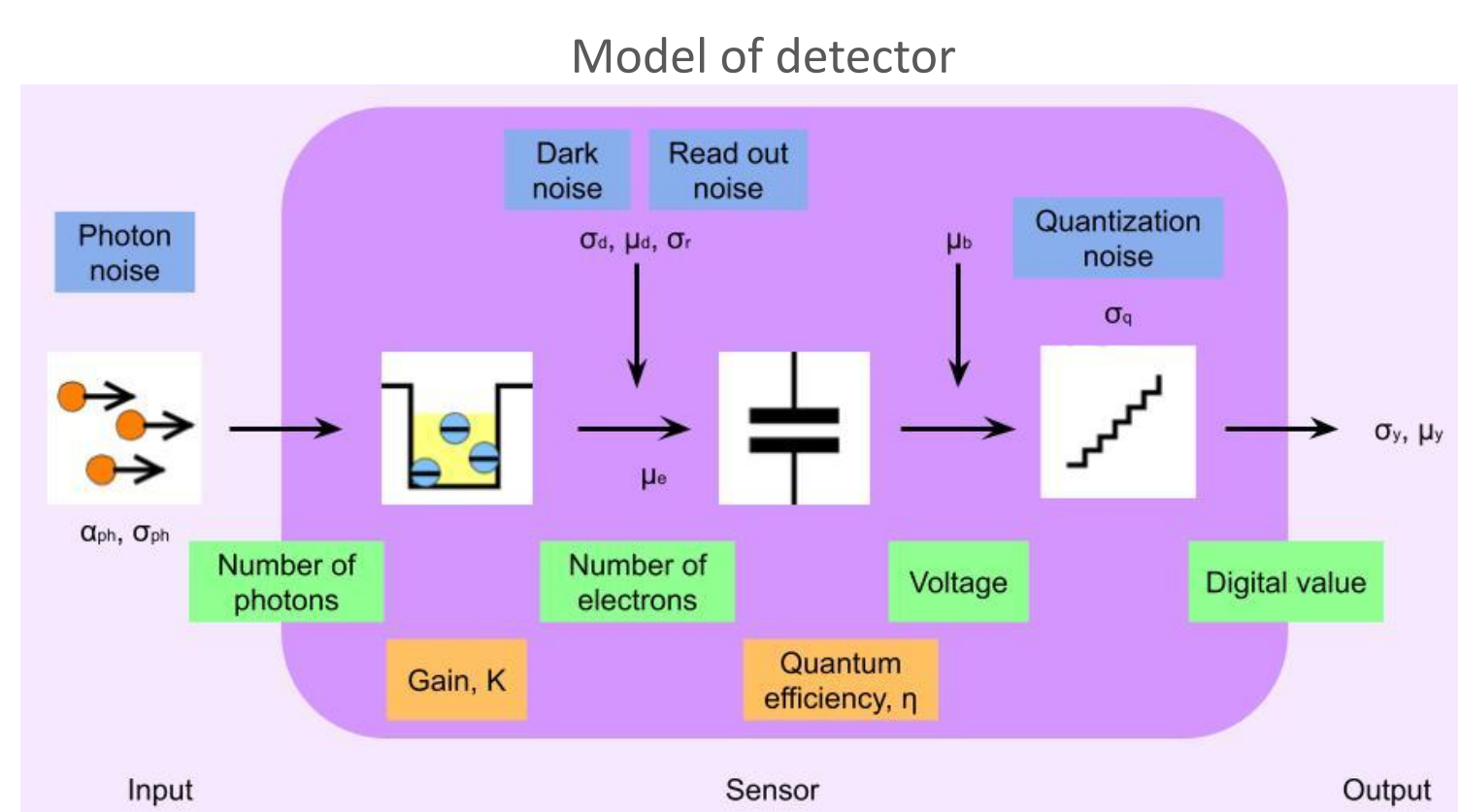

- Need for total field of view coverage : 30 000 x 30 000 px = 1 Gpx
- Current laboratory experiments : Gigapix (Pyxalis) CMOS 8320 x 5436 px = 46 Mpx taille pixel 4.4 μ m taille totale 24 x 26 mm

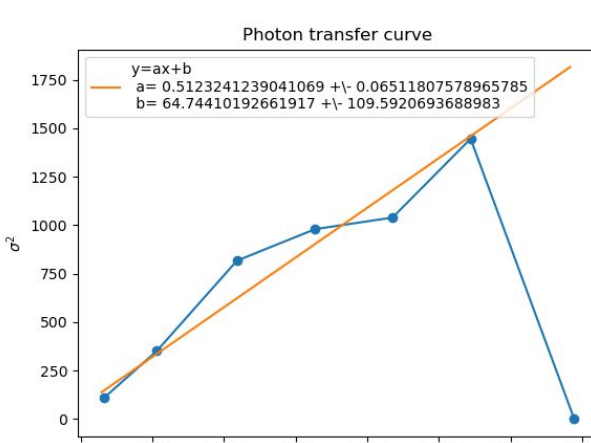
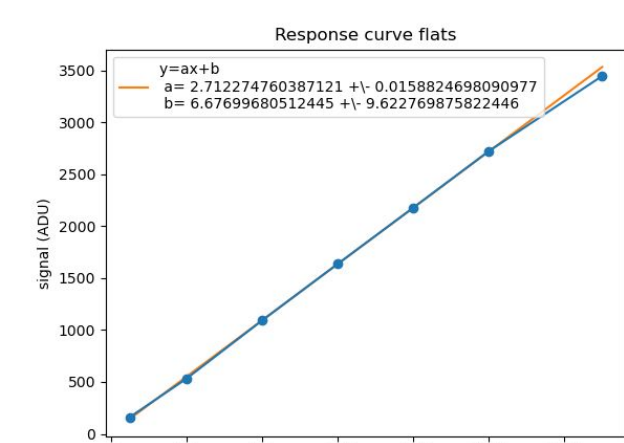

TBC

Interferometric calibration of the pixels centroid position

In a theoretical detector (a), rows and columns are well aligned, but in a real detector (b) the centroids are misaligned (because of fine pixel structure, quantum efficiency local variations ...)

\rightarrow Need of calibration

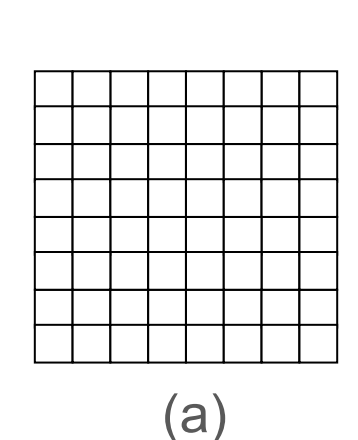

Calibration procedure :

- Fibres create **Young's fringes** on the detector
- Phase modulators make the fringes scroll
- The modulation observed by each pixel provides the position of the centroids
- Precision required \leq 5e-6 px (corresponding to 0.3 μ s, an exo-Earth signal)

- model the field distortion function by a 2D polynomial (T or T1oT2)
- Adjust T thanks to the reference stars in the field of view known with Gaia catalog
- Apply T to the target star to recover its undistorted position

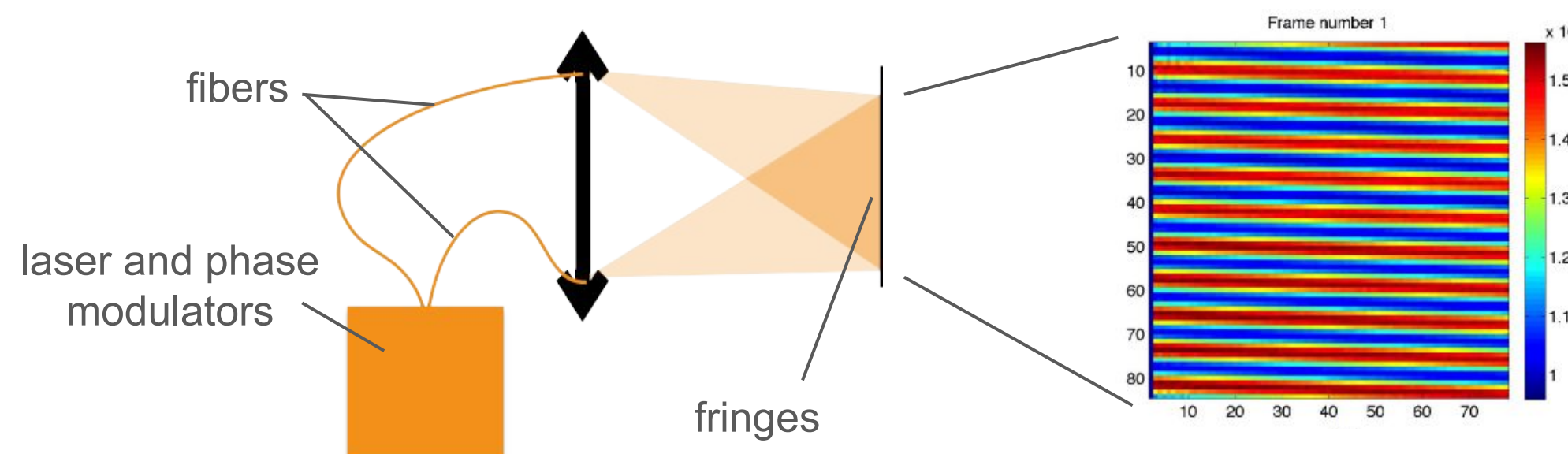

- Proof of concept on small matrices (Crouzier et al. 2016, A&A 595, A108) : 6e-5 px
- performance needs to be validated on large matrices \rightarrow a testbed will be developed at IPAG

Calibration of optical distortion

★ with simulations :

Objectiv : Show that a **polynomial model** is able to calibrate the telescope distortion with a precision smaller than 5e-6 px (corresponding to Earth like planet signal) Recent work on telescope stability (Malbet et al. 2022, SPIE 12180, 1F) has shown that the reference stars in the field of the telescope can be used as metrology sources in order to compute the distortion function

- model the field distortion function by a 2D polynomial (T or T1oT2)
- Adjust T thanks to the reference stars in the field of view known with Gaia catalog
- Apply T to the target star to recover its undistorted position

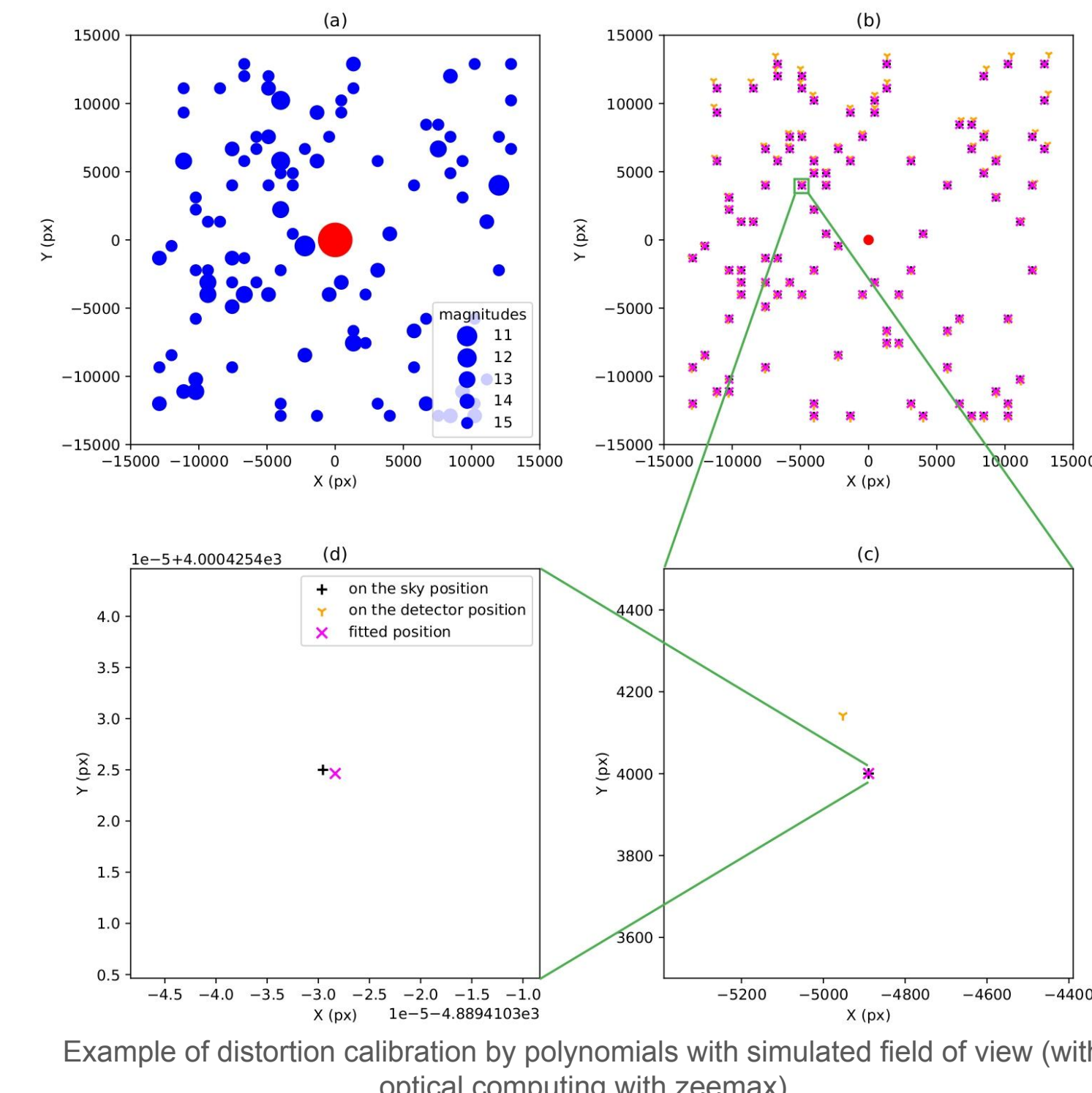

Example of distortion calibration by polynomials with simulated field of view (with optical computing with zeemax)

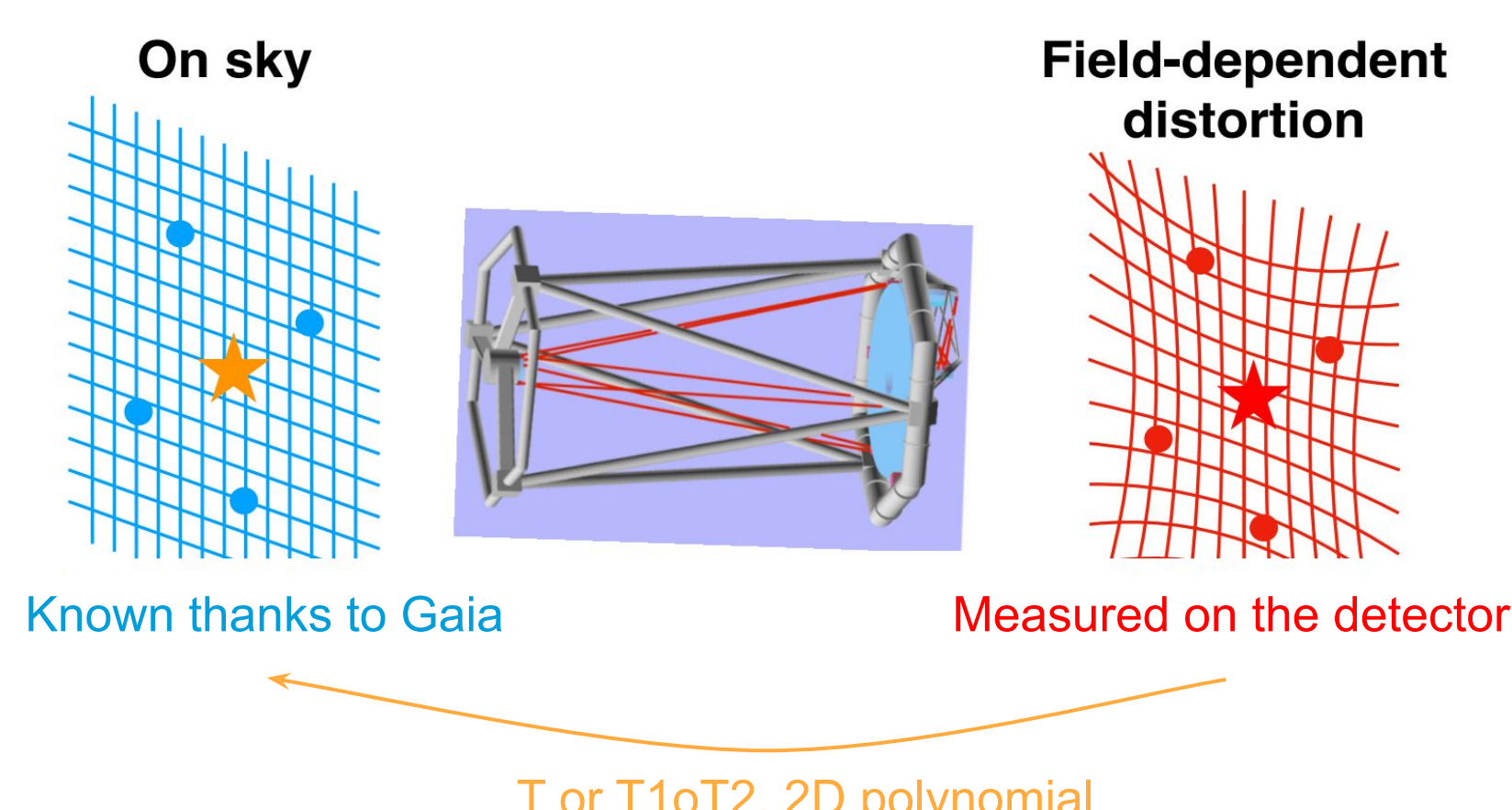

Paper in prep

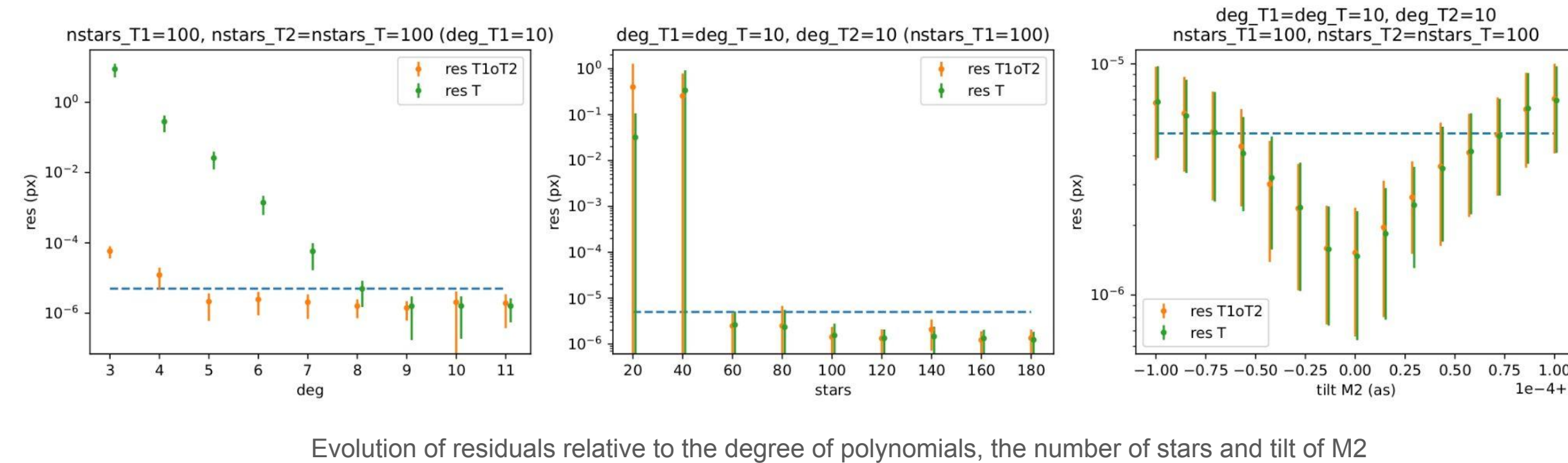

Simulation conclusion : A precision of 5e-6 px can be reached with about 100 stars and an 8th order polynomial

★ in laboratory :

Objectiv : show that the procedure described before works in laboratory

- Illuminating pseudo stars on the LCD screen
- Induce distortion with lens and diaphragm
- Recording distorted star images with the detector
- Apply the previous procedure to recover the undistorted image

