



**HAL**  
open science

## **Influence of current and voltage harmonic distortion on the power measurement of LED lamps and luminaires**

Christophe Martinsons, Yuqin Zong, Cameron Miller, Yoshi Ohno, François Olive,  
Nicolas Picard

### ► **To cite this version:**

Christophe Martinsons, Yuqin Zong, Cameron Miller, Yoshi Ohno, François Olive, et al.. Influence of current and voltage harmonic distortion on the power measurement of LED lamps and luminaires. CIE Centenary Conference "Towards a New Century of Light", Commission Internationale de l'Eclairage (CIE), Apr 2013, Paris, France. pp.290-299. <hal-04675457>

**HAL Id: hal-04675457**

**<https://hal.science/hal-04675457v1>**

Submitted on 26 Aug 2024

**HAL** is a multi-disciplinary open access archive for the deposit and dissemination of scientific research documents, whether they are published or not. The documents may come from teaching and research institutions in France or abroad, or from public or private research centers.

L'archive ouverte pluridisciplinaire **HAL**, est destinée au dépôt et à la diffusion de documents scientifiques de niveau recherche, publiés ou non, émanant des établissements d'enseignement et de recherche français ou étrangers, des laboratoires publics ou privés.



Distributed under a Creative Commons CC BY-NC 4.0 - Attribution - Non-commercial use - International License

## INFLUENCE OF CURRENT AND VOLTAGE HARMONIC DISTORTION ON THE POWER MEASUREMENT OF LED LAMPS AND LUMINAIRES

Christophe Martinsons<sup>1</sup>, Yuqin Zong<sup>2</sup>, Cameron Miller<sup>2</sup>, Yoshi Ohno<sup>2</sup>, François Olive<sup>1</sup>, Nicolas Picard<sup>1</sup>

<sup>1</sup> Centre Scientifique et Technique du Bâtiment, St Martin d'Hères, FRANCE

<sup>2</sup> National Institute of Standards and Technology, Gaithersburg, USA

christophe.martinsons@cstb.fr

### Abstract

Specific issues appear in the measurement of the electrical power of AC-powered LED lamps and luminaires because they often generate harmonic currents in a wide frequency range. The topic of this paper is to clarify the impact of these harmonic currents on the measurement of the active power. When high frequency currents are generated in an electrical circuit, the resulting voltage, current and power become very sensitive to the bandwidth of the measurement devices and to the impedance of the power supply circuit (source impedance). In this paper, several expressions of the error terms in the active power are established as functions of the total harmonic distortion figures of the AC current and the voltage. An experimental set-up was designed to compare the active power measurements performed with different source impedances and different bandwidths on an LED lamp generating high frequency harmonic currents. The active power was typically underestimated by about 3% when the measurement bandwidth was limited to 2 kHz, the IEC-61000-3-2 limit for measuring the power of lighting equipment. Similarly, deviations of about -6% appeared with increasing source impedances.

*Keywords:* LED, lamp, electrical metrology, luminous efficacy, power, power factor, harmonic currents, harmonic distortion, source impedance.

### 1 Introduction

Solid-state lighting (SSL) products such as LED lamps and luminaires are rapidly replacing other light sources in both consumer and professional markets. This massive transition of the lighting industry relies on the increasing performance of SSL products. Many requirements are set by regulations and certifications in order to guarantee that these products are safe and present a minimum level of light quality together with better energy efficiency. The compliance of the products is based on specific measurement standards, such as the IESNA-LM-79 for photometric and electrical properties (IESNA, 2008). In this standard and other lighting standards, the accepted figure of merit for the energy efficiency of SSL products is the luminous efficacy expressed in lumen per watt (lm/W).

A great body of work has been devoted to improving the measurement of the luminous flux (lm) of LEDs and SSL products. The photometric methods used for incandescent and fluorescent light sources presented some difficulties for LED based lamps and luminaires. The completion of LM-79 in the USA in 2008 was an important milestone as it established relevant photometric test protocols that were well accepted by testing laboratories and lighting manufacturers. A similar initiative is currently carried out by CEN in Europe in order to provide a European measurement standard specific to SSL products.

Whereas the measurement of the luminous flux of SSL products can now be achieved with uncertainties of about 2% by testing laboratories, the luminous efficacy is still a difficult parameter to assess because the measurement of the electrical power also presents some challenges that have not yet been studied in depth.

## 2 Specific issues related to the measurement of the AC electrical power of mains powered LED devices

Specific issues appear in the measurement of the electrical power of LED lamps and luminaires. As previously shown in several reports and publications (Uddin, 2012) many built-in electronic drivers generate harmonic currents in a wide frequency range. In Europe, the emission of harmonic currents by SSL products has not yet been regulated. However, many LED lamps were found to exceed the limits set by the IEC 61000-3-2 standard (IEC, 2006) for fluorescent lamps, which can potentially be a concern when LED lamps eventually replace the majority of fluorescent lamps. As with other electronic equipment, the impact of harmonic currents emitted by SSL products is well-known by utility companies and manufacturers of electrical distribution equipment. It is quite usual that SSL products generate harmonic currents at frequencies exceeding 100 kHz or even 1 MHz, well above the limit of about 2 kHz (e.g. 40-th harmonics) that is considered in IEC 61000-3-2.

When high frequency currents are generated in an electrical circuit, the resulting voltage, current and power readings become very sensitive to two factors:

- The bandwidth of the measurement equipment
- The impedance of the power supply circuit (source impedance) which becomes higher at high frequency because of inductive effects.

## 3 Mathematical expressions of the electrical power of lamps generating harmonic currents

The electrical power, expressed in W, refers to the *active* power. It is different from the *apparent* power which is expressed in VA. The ratio of the active power to the apparent power is the power factor. In this section, simple electrical models are proposed in order to derive a mathematical expression of the active power as a function of the current total harmonic distortion, the voltage total harmonic distortion and the complex source impedance.

The total harmonic distortion (*THD*) is very often used to characterise the “quality” of an AC signal, a measure of how “far” the waveform is from a pure sine wave. Current and voltage *THD*, respectively noted  $THD_i$  and  $THD_u$ , are of practical use and can be measured by power analysers. Their mathematical definitions are the following (IEC, 2002):

$$THD_i = \sqrt{\frac{\sum_{n=2} i_n^2}{i_1^2}} \quad (1)$$

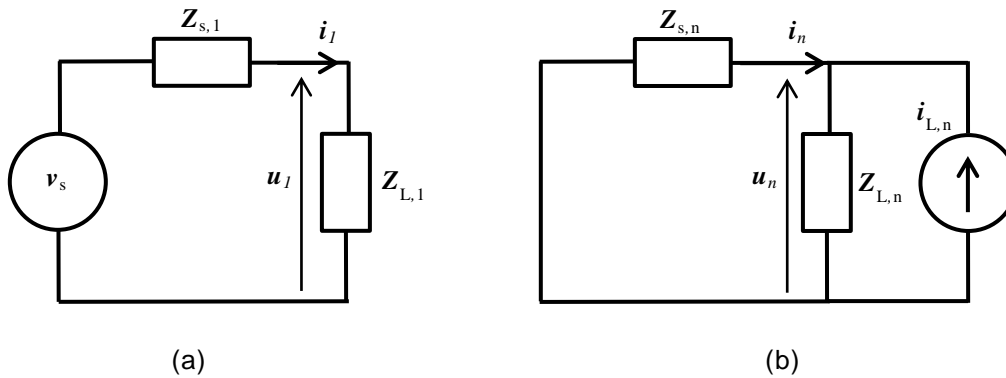
$$THD_u = \sqrt{\frac{\sum_{n=2} u_n^2}{u_1^2}} \quad (2)$$

where  $i_n$  and  $u_n$  respectively are the rms amplitudes of the  $n$ -th Fourier components of the current and voltage periodic waveforms  $i(t)$  and  $u(t)$ . The index  $n=1$  corresponds to the mains frequency  $f_1$  (e.g. 50 Hz in Europe and 60 Hz in the USA). The harmonic frequency of order  $n$  is equal to  $nf_1$  and is noted  $f_n$ .

### 3.1 Equivalent electrical circuit of an AC-powered LED lamp

At the mains frequency  $f_1$ , an AC-powered LED lamp can be modelled as a linear load having an impedance  $Z_{L,1}$ . At the harmonic frequency  $f_n$ , the lamp is assumed to be a source of harmonic current  $i_{L,n}$ , coupled to a load impedance  $Z_{L,n}$  (Tsukamoto, 2000). Figure 1 shows two equivalent electrical circuits, the first one at frequency  $f_1$  and the second one at the harmonic frequency  $f_n$ . In these models,  $Z_{s,1}$  is the source impedance at  $f_1$  and  $Z_{s,n}$  is the source impedance at  $f_n$ . The power supply is assumed to be a generator of pure sine wave voltage (no harmonic components)  $v_s$ .

The current  $i_n$  and voltage  $u_n$  are respectively the complex  $n$ -th Fourier coefficients of the voltage and current waveforms,  $i(t)$  and  $u(t)$ , measured at the lamp socket.



**Figure 1 – Equivalent electrical circuits of an AC-powered lamp and its AC power supply. Diagram (a) is the equivalent circuit at mains frequency  $f_1$ . Diagram (b) is the equivalent circuit at harmonic frequency  $f_n$ . The lamp is modelled by a load impedance and a generator of harmonic current  $i_{L,n}$ .**

From the equivalent circuit at  $f_1$ , it is possible to find expressions of the source impedance  $Z_{s,1}$  and load impedance  $Z_{L,1}$  at the mains frequency:

$$Z_{s,1} = \frac{v_s - u_1}{i_1} \quad (3)$$

$$Z_{L,1} = \frac{u_1}{i_1} \quad (4)$$

From the equivalent circuit at  $f_n$ , we see that the complex current  $i_n$  and complex voltage  $u_n$  are linked together by the source impedance  $Z_{s,n}$ :

$$u_n = Z_{s,n} i_n \quad (5)$$

Furthermore,  $i_n$  and  $u_n$  can be expressed as functions of the harmonic current  $i_{L,n}$  generated by the lamp:

$$i_n = \frac{Z_{L,n}}{Z_{s,n} + Z_{L,n}} i_{L,n} \quad (6)$$

$$u_n = \frac{Z_{s,n} Z_{L,n}}{Z_{s,n} + Z_{L,n}} i_{L,n} \quad (7)$$

Equations (6) and (7) show that harmonic currents and voltages measured at the lamp socket are both proportional to the harmonic current directly generated by the lamp. In addition, if the source impedance is null (in the case of an ideal power supply circuit), then there is no harmonic voltage generated, thereby leading to a null  $THD_u$ . This fact is very useful as it provides a first criterion to check whether the source impedance is low enough to be adapted to the lamp to be measured: if the voltage harmonic distortion is greater than the intrinsic voltage harmonic distortion of the AC power supply, then the source impedance is too high for some harmonic frequencies. A voltage drop therefore appears, leading to a distortion of the voltage waveform. In the next subsection, the influence of non-negligible source impedance on the electrical power measurement is investigated.

### 3.2 Mathematical expression of the active power

The active power  $P$  can be calculated in the frequency domain from the rms-amplitudes of the  $n$ -th order Fourier components of voltage and current (Svensson, 1999):

$$P = \sum_{n=1} u_n i_n \cos \varphi_n \quad (8)$$

where  $\varphi_n$  is the phase angle between  $i_n$  and  $u_n$ .

$P$  can be written as the sum of  $P_1$ , the active power at the mains frequency only (fundamental active power), and  $P_H$ , the resulting active power of all the harmonic components (harmonic active power):

$$P_1 = u_1 i_1 \cos \varphi_1 \quad (9)$$

$$P_H = \sum_{n=2} u_n i_n \cos \varphi_n \quad (10)$$

### 3.2.1 Variation of the fundamental active power with respect to the source impedance

Substituting  $u_1$  and  $i_1$  by their expressions derived from eq. (3) and eq. (4) in eq. (9) gives the expression of  $P_1$  as a function of  $Z_{s,1}$ :

$$P_1 = v_s^2 \cos \varphi_1 \frac{|Z_{L,1}|}{|Z_{L,1} + Z_{s,1}|^2} \quad (11)$$

This formula shows that the fundamental active power decreases when the source impedance increases. At the mains frequency, the source impedance is usually much smaller than the load impedance. A first order Taylor expansion of the bracket in eq. (11) gives the following approximation:

$$P_1 \cong \frac{v_s^2 \cos \varphi_1}{|Z_{L,1}|} \left( 1 - 2 \left| \frac{Z_{s,1}}{Z_{L,1}} \right| \right) \quad (12)$$

The introduction of non-zero source impedance is therefore responsible for a relative deviation of the fundamental active power approximately equal to twice the ratio of the source impedance to the load impedance at the mains frequency:

$$\delta P_1 / P_1 \cong 2 \left| \frac{Z_{s,1}}{Z_{L,1}} \right| \quad (13)$$

The source impedance  $Z_{s,1}$  at mains frequency is expected to be very small but its precise evaluation is difficult to achieve since the source impedance is a distributed parameter.

### 3.2.2 Variation of the harmonic active power with respect to the source impedance

Any non-zero source impedance at harmonic frequencies is responsible for adding  $P_H$  to the active power. It is interesting to have a worst-case estimation of  $P_H$  (e.g. an extreme value of  $P_H$ ) in order to assess the maximum error introduced by the harmonics. Since harmonic currents are generated by the lamp, the harmonic active power is negative (harmonic currents flow from the load to the source). As a result, the active power decreases when the source impedance increases. The extreme value of  $P_H$  corresponds to phase angles  $\varphi_n$  equal to  $\pi$ , giving a cosine value of -1 for all the harmonic orders  $n$ .

Under this assumption, the complex source impedance is the real number  $-R_s$ , where  $R_s$  is a worst-case source resistance at harmonic frequencies. Eq. (10) leads to the following simplified formulas for  $P_H$ :

$$P_H = -R_s \sum_{n=2} i_n^2 = -\frac{1}{R_s} \sum_{n=2} u_n^2 \quad (14)$$

The definition of  $THD_i$  and  $THD_u$  given by eq. (1) and eq. (2) can be introduced in eq. (14), which gives the following result:

$$P_H = -u_1 i_1 THD_u THD_i \quad (15)$$

The corresponding relative deviation of the active power introduced by the harmonic currents is given by  $P_H / P_1$ :

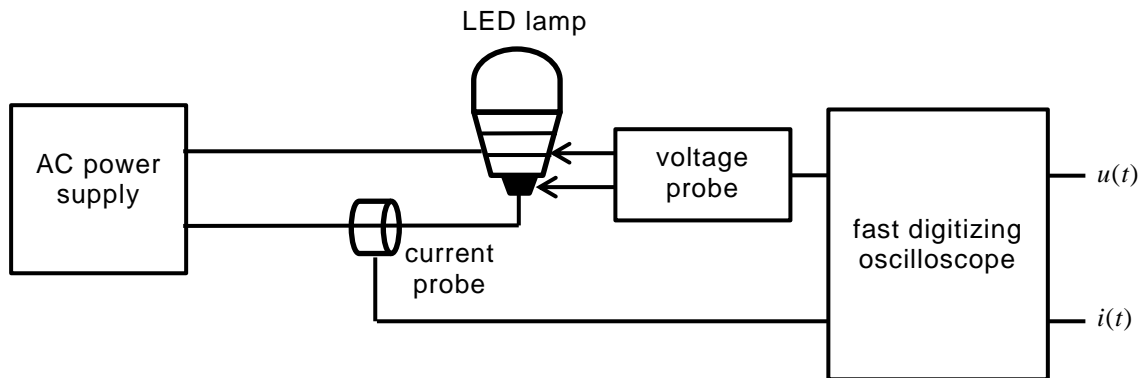
$$P_H / P_1 = \frac{-THD_u THD_i}{\cos \varphi_1} \quad (16)$$

This result is very interesting because it gives the worst-case expected deviation of the active power introduced by the harmonic currents flowing through the source impedance of the lamp circuit, without having to know the value of the source impedance itself. This deviation can be calculated from the values of  $THD_i$ ,  $THD_u$  and  $\cos(\varphi_1)$ , also known as the differential power factor (DPF). These three parameters can be measured with a power analyser.

## 4 Experimental study of the active power of an LED lamp with a high current total harmonic distortion

### 4.1 Experimental setup

An experimental set-up was designed and implemented at the NIST photometry laboratory to study the active power of an LED lamp as a function of the source impedance and the measurement bandwidth. The chosen LED lamp was a 120 V and 60 Hz AC-powered LED lamp known to exhibit a highly distorted current waveform. The experimental setup is depicted in Figure 2.



**Figure 2 – Diagram of the experimental setup used to measure the current and voltage waveforms**

The principle of the experiment is to carry out time-domain electrical measurements and to numerically compute the active power and other parameters of interest.

A four-pole lamp socket is used together with a high impedance voltage probe to measure the input voltage directly across the lamp contacts. The lamp current is measured by a non-contact current transformer having a sensitivity with flat frequency response from 1 Hz to 20 MHz. Both the voltage probe and the current probe are connected to a fast digitizing oscilloscope used to acquire the voltage and current waveforms  $u(t)$  and  $i(t)$  in the time domain over an integer number of mains voltage periods. The minimum sampling rate used in the experiments was 0,24  $\mu$ s.

### 4.2 Time-domain computations

The active power  $P$  can be computed in the time domain using  $u(t)$  and  $i(t)$  through the following formula (IEC, 2002):

$$P = \frac{1}{T} \int_T u(t)i(t)dt \quad (17)$$

where  $T = 1/f_1$  is the period of the mains voltage. The real and imaginary parts of the fundamental components  $i_1$  and  $u_1$  are computed using the definition of the coefficients of the Fourier expansion (IEC, 2002):

$$\text{Re}(\mathbf{i}_1) = \frac{\sqrt{2}}{T} \int_T i(t)\cos(2\pi f_1 t)dt \quad ; \quad \text{Im}(\mathbf{i}_1) = \frac{\sqrt{2}}{T} \int_T i(t)\sin(2\pi f_1 t)dt \quad (18)$$

$$\text{Re}(\mathbf{u}_1) = \frac{\sqrt{2}}{T} \int_T u(t)\cos(2\pi f_1 t)dt \quad ; \quad \text{Im}(\mathbf{u}_1) = \frac{\sqrt{2}}{T} \int_T u(t)\sin(2\pi f_1 t)dt \quad (19)$$

From these values, the phase angle  $\varphi_1$ , the differential power factor  $\cos(\varphi_1)$ , the rms-amplitudes  $u_1$  and  $i_1$  can be determined using classical formulas of complex algebra.

The rms amplitudes  $u_{\text{rms}}$  and  $i_{\text{rms}}$  of the measured voltage and current are computed using the formulas:

$$u_{\text{rms}} = \sqrt{\frac{1}{T} \int_T (u(t) - u_{DC})^2 dt} \quad ; \quad i_{\text{rms}} = \sqrt{\frac{1}{T} \int_T (i(t) - i_{DC})^2 dt} \quad (20)$$

where  $i_{DC}$  and  $u_{DC}$  are the residual DC components (average values over one period) of the waveforms.

Two other important quantities can be calculated: the apparent power  $S$ , expressed in VA, and the power factor  $PF$ , which is the ratio of the active power to the apparent power.

$$S = i_{\text{rms}}u_{\text{rms}} \quad (21)$$

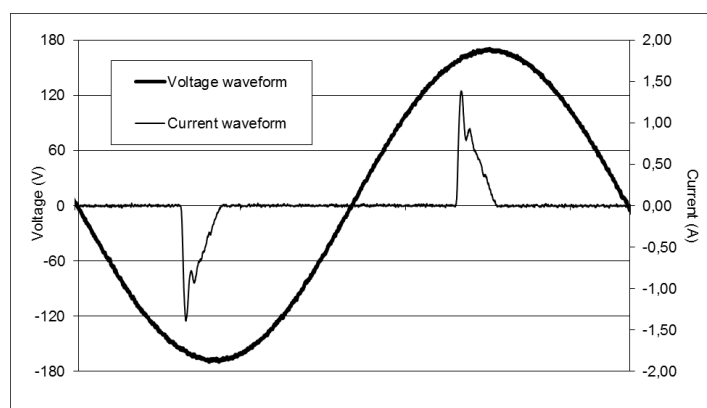
$$PF = P/S \quad (22)$$

It is interesting to note that the total harmonic distortions can be calculated from the quantities computed above in the time domain, without having to calculate all the coefficients of the Fourier series. As a matter of fact, the definition of the total harmonic distortion combined with the Parseval's theorem yields the following formulas:

$$THD_i = \sqrt{\left(\frac{i_{\text{rms}}}{i_1}\right)^2 - 1} \quad ; \quad THD_u = \sqrt{\left(\frac{u_{\text{rms}}}{u_1}\right)^2 - 1} \quad (23)$$

## 5 Experimental results

Figure 3 shows the voltage and current waveforms acquired with a sampling rate of 4,8  $\mu\text{s}$ , corresponding to a bandwidth of about 100 kHz.



**Figure 3 – Current and voltage waveforms measured with the setup of figure 2.**

Table 1 shows the parameters computed from the waveforms of figure 3.

**Table 1 – Parameters estimated from the measured waveforms of figure 3.**

Active power $P$	Fundamental active power $P_1$	Harmonic active power $P_H = P - P_1$	Apparent power $S$	Power factor PF	$\cos(\varphi_1)$	$THD_u$	$THD_i$
13,83 W	13,87 W	-0,04 W	31,47 VA	0,44	0,974	0,008	1,969

The worst-case harmonic active power estimated using eq.(15) is -0,22 W. However, the measured harmonic active power is -0,04 W, which is a much smaller amount. The source impedance of the experimental setup introduces an error of less than 0,3% in the measurement of the active power.

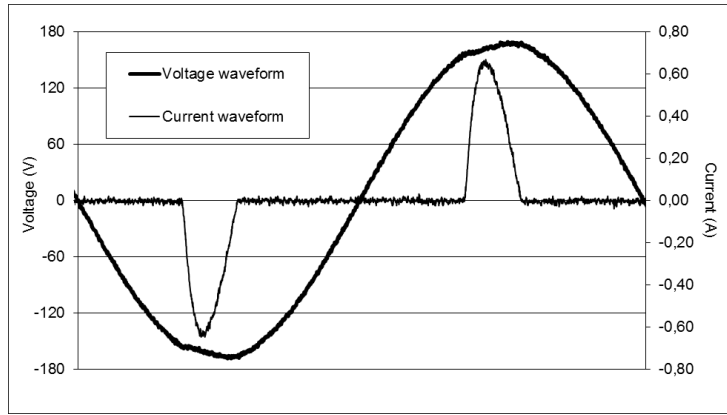
### 5.1 Variation of the active power as a function of source impedance

The AC power supply of the setup allows the user to set an additional source resistance. Although this setting is not calibrated, it is useful to study the effect of adding more resistance to the power supply circuit.

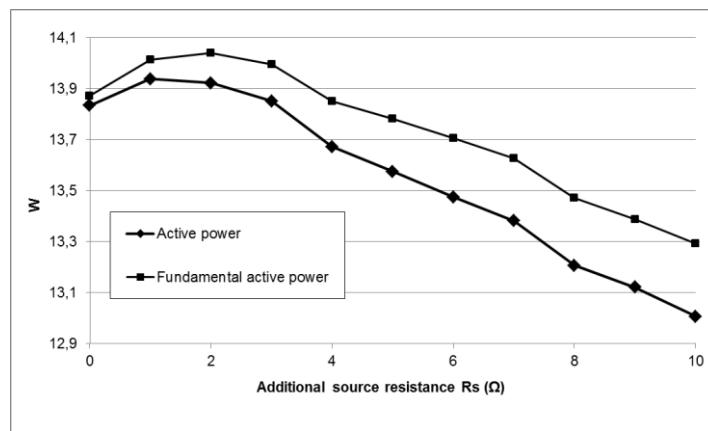
Waveform measurements were taken with additional source resistance values ranging from 1  $\Omega$  to 10  $\Omega$  by step of 1  $\Omega$ . The power supply output voltage is increased at each step so that the rms-voltage measured at the lamp socket remains constant throughout the series of measurements.

The first noticeable effect of increasing the source resistance is the increasing distortion of the voltage waveform while, at the same time, the distortion of current waveform decreases. This effect is noticeable in figure 4 and is explained by the voltage drop caused by harmonic currents flowing through the source impedance. This behaviour is typical of all non-linear single phase loads (Svensson, 1999).

The variations of the measured active power  $P$  and fundamental active power  $P_1$  are shown in figure 5. This graph shows that the active power and the fundamental active powers both decrease when the additional source resistance is increased beyond 2  $\Omega$ . This fact is consistent with eq.(11), in which the ratio of the load impedance to the source impedance cannot be neglected. With the highest source resistance value, the measured active power is 6% less than the value obtained with the lowest source resistance.

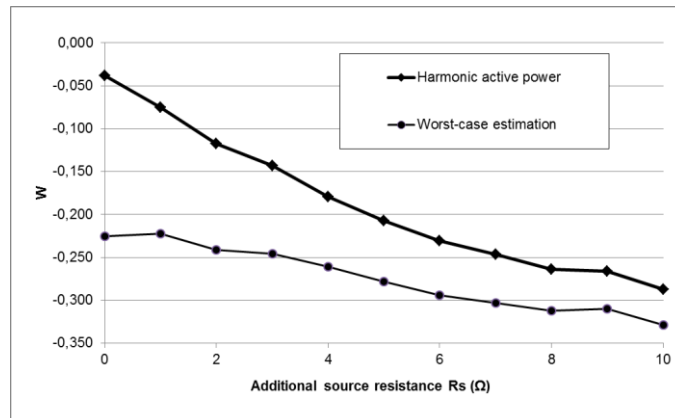


**Figure 4 – Voltage and current waveforms measured with an additional source resistance of 10 Ω. This high source resistance causes a higher harmonic distortion of the voltage waveform and a lower harmonic distortion of the current waveform.**



**Figure 5 – Variation of the active power  $P$  and the fundamental active power  $P_1$  of the LED lamp as a function of the additional source resistance introduced in the lamp power supply circuit.**

The harmonic active power  $P_H$  can be estimated from the difference between  $P$  and  $P_1$ . Figure 6 shows that the absolute value of  $P_H$  steadily increases with the increasing source resistance. As can be expected, when the source resistance is increased, the harmonic active power becomes closer to the worst-case limit given by eq. (15).



**Figure 6 – Variation of the harmonic active power  $P_H$  of the LED lamp as a function of the additional source resistance introduced in the power supply circuit. The worst-case estimation is given by Eq. (15).**

### 5.2 Variation of the power factor as a function of source impedance

The measurements show that the apparent power decreases more rapidly than the active power when the source resistance is increased. As a result, the power factor increases regularly with the source resistance, as the graph of figure 7 shows.

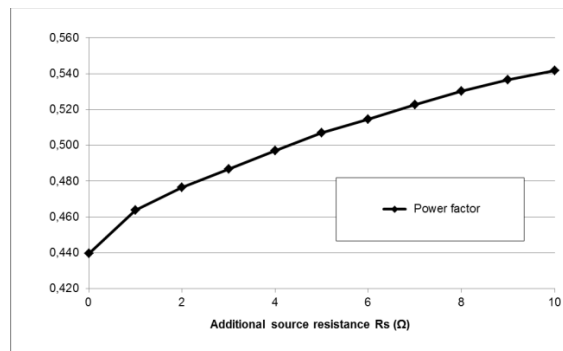


Figure 7 – Variation of the power factor of the LED lamp with the additional source resistance

### 5.3 Influence of the measurement bandwidth on the electrical measurements

The measurement bandwidth is an important parameter when high frequency harmonic currents are generated by the lamp. Using the setup described above, it is possible to simulate different measurement bandwidths by changing the sampling rate of the digitizing oscilloscope. The results show that the active power of the LED lamp significantly decreases when the measurement bandwidth is less than 10 kHz (figure 8). The reduction of the bandwidth also produced an increase in the power factor of the LED lamp (figure 9).

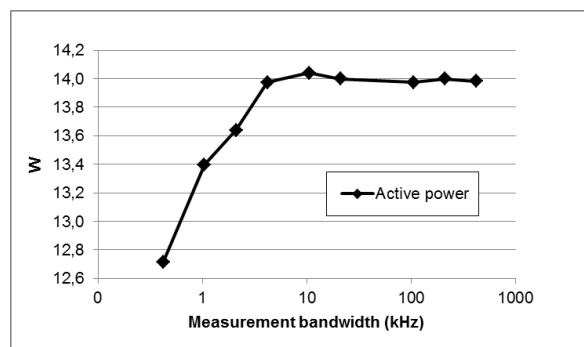


Figure 8 – Active power of the LED lamp as a function of the measurement bandwidth.

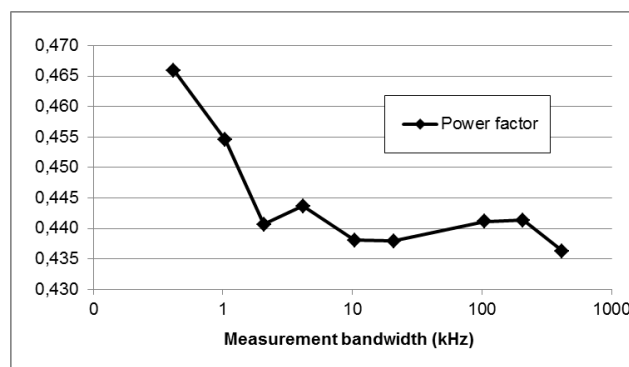


Figure 9 – Power factor of the LED lamp as a function of the measurement bandwidth.

## 6 Conclusions

The electrical power of AC-powered LED devices was investigated considering that they are non-linear single phase loads. The theoretical analysis of equivalent circuits shows that harmonic currents flow through the source impedance and are responsible for a negative harmonic power which reduces the measured active power. The source impedance is therefore directly involved in the harmonic active power. At the mains frequency, the source impedance also has a small effect on the fundamental active power (power of mains frequency components).

Experimental measurements carried out on an LED lamp showed that with the lowest possible source impedance, the harmonic power was less than 0,3% of the active power. However, for a source impedance as high as 10  $\Omega$ , the active power decreased by 6% which reflected a degradation of the fundamental active power combined with an increase of the harmonic power.

As a general rule, the source impedance should be kept as low as possible when performing power measurements. However, a practical method was given here in order to assess the effects of the source impedance on the power measurements carried out with distorted AC current and voltage. The method is based on electrical parameters that can be measured with most commercial power analysers.

The effect of the bandwidth of the electrical measurement equipment was also experimentally investigated on an LED lamp. The active power was typically underestimated by about 3% when the measurement bandwidth was limited to 2 kHz, the IEC-61000-3-2 limit for measuring the power of lighting devices. In the case of the tested lamp, the measurement bandwidth had to be greater than 20 kHz to give valid power measurements.

The results presented in this paper show that the power of AC SSL devices can be underestimated because requirements on instrument bandwidth, source impedance and total harmonic distortion are not yet specified in measurement standards.

The authors are grateful to the French "Institut Carnot" for providing the financial support for this work that was done during the stay of Christophe Martinsons at NIST as a guest researcher in July and August 2012.

## References

LM-79:2008, IESNA Approved Method for the Electrical and Photometric Measurements of Solid-State Lighting Products, IESNA, 2008

UDDIN, S., SHAREEF, H., MOHAMED, A., HANNAN, M.A., "An analysis of harmonics from LED lamps", *Proceedings of 2012 Asia-Pacific Symposium Electromagnetic Compatibility (APEMC)*, pp.837-840, 21-24 May 2012, Singapore

IEC 61000-3-2:2006, Electromagnetic compatibility (EMC): Limits for harmonic current emissions (equipment input current < 16 A per phase)

IEC 61000-4-7:2002, Electromagnetic compatibility (EMC): Testing and measurement techniques – General guide on harmonics and interharmonics measurements and instrumentation, for power supply systems and equipment connected thereto

TSUKAMOTO, M., OGAWA, S., NATSUDA, Y., MINOWA, Y., NISHIMURA, S., "Advanced technology to identify harmonics characteristics and results of measuring," *Proceedings of Ninth International Conference on Harmonics and Quality of Power*, pp.341-346, 2000

SVENSSON S., "Power measurement techniques for non-sinusoidal conditions. The significance of harmonics for the measurement of power and other AC quantities", Ph.D thesis, Chalmers University of Technology, Göteborg, Sweden, 1999