



HAL
open science

Ecosystem based approach to assess the impact of invasive or expanding species in the lower Saône River

T. Changeux, A Dragotta, Evelyne Franquet, N Stolzenberg, Jf Fruget, L Marion, C Souty-Grosset, O. Anneville, Laurent Cavalli, Jp Faure, et al.

► **To cite this version:**

T. Changeux, A Dragotta, Evelyne Franquet, N Stolzenberg, Jf Fruget, et al.. Ecosystem based approach to assess the impact of invasive or expanding species in the lower Saône River. *Anthropocene*, 2024, 47, pp.100446. 10.1016/j.ancene.2024.100446 . hal-04675380

HAL Id: hal-04675380

<https://hal.science/hal-04675380v1>

Submitted on 22 Aug 2024

HAL is a multi-disciplinary open access archive for the deposit and dissemination of scientific research documents, whether they are published or not. The documents may come from teaching and research institutions in France or abroad, or from public or private research centers.

L'archive ouverte pluridisciplinaire **HAL**, est destinée au dépôt et à la diffusion de documents scientifiques de niveau recherche, publiés ou non, émanant des établissements d'enseignement et de recherche français ou étrangers, des laboratoires publics ou privés.

1
2
3
4
5
6
7
8
9
10
11
12
13
14
15
16
17
18
19
20
21
22
23
24
25
26
27
28
29
30
31
32
33
34
35
36
37
38
39
40
41
42

Title

Ecosystem based approach to assess the impact of invasive or expanding species in the lower Saône River

Author names and affiliations

Changeux T.(1), Dragotta A. (1), Franquet E. (2), Stolzenberg N. (3), Fruget JF (4), Marion L. (5), Souty-Grosset C. (6), Anneville O. (7), Cavalli L. (2), Faure JP (8), Corget N. (9), Josserand F (10). et Bănaru D. (1)

1 : Aix Marseille Univ, Université de Toulon, CNRS, IRD, MIO, Marseille, France

2 : IMBE-Aix Marseille Université, CNRS, IRD, Univ. Avignon, 13397 Marseille – 13397 Marseille

3 : Comité national de la pêche professionnelle en eau douce - 44320 Saint-Viaud

4 : ARALEP – Ecologie des eaux douces - 69603 Villeurbanne

5 : ECOBIO Université de Rennes

6 : Ecologie et Biologie des Interactions, Equipe EES, Université de Poitiers, 86022 Poitiers

7 : Université Savoie Mont Blanc, INRAE, CARTELE - Thonon-les-Bains

8 : Fédération de pêche du département du Rhône, 69890 La Tour De Salvagny

9 : Retired from Service de la Navigation de Mâcon

10: Professional fishers of Saône River for 40 years

Corresponding author

Changeux T (ORCID 0000-0002-0418-3321). e-mail : thomas.changeux@ird.fr

Affiliation: MIO

Highlights (85 characters max per bullet point)

- A static trophic model (Ecopath) is applied to lower Saône River before and after 3 invasive species arrivals
- *Corbicula fluminea* can explain the triggering of the ecosystem shift towards a functioning where summer phytoplankton blooms are rarer
- *Phalacrocorax carbo* appears to have little influence
- *Silurus glanis* development maintains important trophic flows in substitution for the decrease in angling landings

Abstract (250 words)

The spread of invasive alien species is identified as one of the most important threats to freshwater ecosystems as they can modify their trophic structure, biomass and flows. The lower Saône River is one of the most biologically productive waterways in France. It has been in strong interaction with a wide range of human activities such as fisheries for at least three millennia. To implement an ecosystem based approach, an Ecopath static trophic model was used for the first time in this river to quantify the role of three invasive or expanding species over two contrasted periods (1988-1993 and 1994-2005). The parameters used in the model integrate on the one hand catch data from fishers (professional, amateur fishing gear users, and anglers), and on the other hand the available literature data on species biomass, diet and the expert assessments of scientists and managers. Species such as the filtering Asian clam *Corbicula fluminea* may explain the triggering of the ecosystem shift towards a functioning where summer phytoplankton blooms are rarer. In the high trophic levels, the great

43 cormorant *Phalacrocorax carbo* appears to have low trophic impact while the development of a large
44 population of European catfish *Silurus glanis* has a strong effect, maintaining important trophic flows
45 in the ecosystem in substitution for the decrease in angling landings.

46 **Keywords (6 max.)**

47 Ecopath with Ecosim (EwE), fishery, large river, trophic model, diversity.

48 **Funding**

49 The project leading to this publication has received funding from Excellence Initiative of Aix-Marseille
50 University - A*MIDEX, a French *Investissements d’Avenir* programme, from the *Office Français de la*
51 *Biodiversité* via the *Comité National de la Pêche Professionnelle en Eau Douce*, and the *Etablissement*
52 *Publics Territorial de Bassin Saône-Doubs*.

53 **Credit authorship contribution statement**

54 Conceptualization, Data curation, Methodology, Software, Supervision, Validation, Visualization (TC,
55 AD, EF, DB), Formal analysis (TC, AD, EF, DB), Funding acquisition (TC, NS, EF), Project administration
56 (TC, EF), Resources (TC,EF), Investigation (TC, AD, EF, NS, JFF, LM, CSG, OA, LC, JPF, NC, FJ, DB),
57 Writing (TC, OA, DB, CSG, JFF, LM).

58 **Declaration of Competing Interest**

59 None

60 **Acknowledgements**

61 We are grateful to Christian Genz, from the Mediterranean Institute of Oceanography, for his helping
62 to draw the Saône basin map, and Philippe Prompt from *Groupe de Recherche et d’Etudes Biologie et*
63 *Environnement* (GREBE-Lyon), for additional information on the recent situation with regard to
64 *Dreissena rostriformis*. Special thanks also to Nicolas Roset and Sandro Parusatti of the *Office français*
65 *de la biodiversité* (Lyon) for providing additional electrofishing and gill-net sampling data, and Jason
66 Link, from National Oceanic and Atmospheric Administration-Fisheries (USA), Jeroen Stennbeek,
67 from Ecopath International Initiative (Spain), Laura Uusitalo and colleagues, from Natural Resources
68 Institute (Finland) and other Finnish organisms for sharing their experience in PREBAL diagnostic.

69

70

71 **Title**

72 Ecosystem based approach to assess the impact of invasive or expanding species in the lower Saône
73 River

74 **Highlights (85 characters max per bullet point)**

- 75 • A static trophic model (Ecopath) is applied to lower Saône River before and after 3 invasive
76 species arrivals
- 77 • *Corbicula fluminea* can explain the triggering of the ecosystem shift towards a functioning
78 where summer phytoplankton blooms are rarer
- 79 • *Phalacrocorax carbo* appears to have little influence
- 80 • *Silurus glanis* development maintains important trophic flows in substitution for the
81 decrease in angling landings

82 **Abstract (250 words)**

83 The spread of invasive alien species is identified as one of the most important threats to freshwater
84 ecosystems as they can modify their trophic structure, biomass and flows. The lower Saône River is
85 one of the most biologically productive waterways in France. It has been in strong interaction with a
86 wide range of human activities such as fisheries for at least three millennia. To implement an
87 ecosystem based approach, an Ecopath static trophic model was used for the first time in this river to
88 quantify the role of three invasive or expanding species over two contrasted periods (1988-1993 and
89 1994-2005). The parameters used in the model integrate on the one hand catch data from fishers
90 (professional, amateur fishing gear users, and anglers), and on the other hand the available literature
91 data on species biomass, diet and the expert assessments of scientists and managers. Species such as
92 the filtering Asian clam *Corbicula fluminea* may explain the triggering of the ecosystem shift towards
93 a functioning where summer phytoplankton blooms are rarer. In the high trophic levels, the great
94 cormorant *Phalacrocorax carbo* appears to have low trophic impact while the development of a large
95 population of European catfish *Silurus glanis* has a strong effect, maintaining important trophic flows
96 in the ecosystem in substitution for the decrease in angling landings.

97 **Keywords (6 max.)**

98 Ecopath with Ecosim (EwE), fishery, large river, trophic model, diversity.

99 **1 Introduction**

100 For strictly freshwater organisms, each watershed and sub-watershed is separated by impassable
101 barriers of land or seawater that have led biogeographers to consider them as islands (Brown and
102 Lomolino, 1998; Hugueny et al., 2010). Therefore, freshwater ecosystems are highly sensitive to
103 species introductions (Russell et al., 2017). When considering all freshwater ecosystems at global
104 level, the spread of invasive alien species is considered to be among the most important threats to
105 freshwater aquatic biodiversity (Dudgeon et al., 2006) and in second place, after climate change,
106 among the emerging threats (Reid et al., 2019). In particular, they can modify the trophic structure
107 with variable consequences for the other species present before their arrival (Gallardo et al., 2016;
108 David et al. 2017).

109 In the last twenty years, the need to carry out an ecological diagnosis in application of the European
110 Water Framework Directive (European Commission, 2000) has oriented research towards biological
111 methods using indices based on taxonomic groups such as plants, invertebrates, fish, etc. In parallel,
112 supported by the ecosystem approach to fisheries promoted by FAO (Garcia et al., 2003), there are
113 integrative approaches that take into account the ecosystem as a whole, such as the ecosystem-
114 based quality indices recently proposed for the application of the European Marine Strategy
115 Framework Directive (European Commission, 2008) by Boudouresque et al. (2020).

116 Among these ecosystem-based approaches, trophic modeling seeks to quantify the biomass and
117 matter flows between the species gathered in trophic groups. Its use has become widespread thanks
118 to the development of the Ecopath with Ecosim (EwE) software suite (Christensen and Walters, 2004)
119 since the mid-1980s, mainly in marine environments (Coll  ter et al., 2015). Initially developed to
120 support fisheries management, EwE is also used to measure, explain, and even sometimes try to
121 predict the impact of invasive species (Corrales et al., 2017). A quick review of the 41 articles
122 returned by the query 'invasion' and 'Ecopath' (all fields) in the Web of Science database (Table S1)
123 shows that the use of EwE to assess the impact of invasive species has been increasing since 2008,
124 with 51% in freshwater ecosystems, because of their particular sensitivity in comparison with marine
125 ecosystems, but only 2% in rivers (Middle and Upper Mississippi, Table S1).

126 Large rivers appear to be particularly suitable ecosystems for the application of trophic modeling
127 because they support high biomasses and develop large food webs (Welcomme, 1985). In the Rh  ne
128 basin, the Sa  ne River, with its associated floodplain, appears as the major large river of the
129 watershed hosting a typical pattern of biodiversity (Godreau et al., 1999). This major Rh  ne river
130 tributary has promoted numerous human activities for at least three millennia (Bonnamour, 2000)
131 and has been subject to the arrival of numerous allochthonous species (see Keith and Poulet (2020)
132 for fishes). The associate high biomass productivity has over the centuries allowed the lower part of
133 the Sa  ne to host one of the largest riverine fishery activities in the watershed (Changeux, 1996;
134 Changeux and Zylberblat, 1993a, 1993b) and more broadly in the whole of the French metropolitan
135 territory (Changeux, 2011). The presence of professional and amateur fishers, allowed to use gears
136 and nets under catch declaration conditions since 1988, provides access to original data related to
137 the biomass of exploited resources up to 2005, when monitoring became less regular.

138 During this same period 1988-2005, in the mid-1990s, the functioning of the lower Sa  ne profoundly
139 changed from a turbid to a clear water state. The turbid state is characterized by high summer
140 production of phytoplankton, responsible for a high load of suspended matter. Conversely, the clear
141 state is characterized by strong water transparency and an extension of macrophyte communities to
142 deeper parts of the river. To our knowledge, this regime shift, attested by numerous testimonies that

143 have referred to them as 'transparencies', has only been documented in two unpublished reports
144 (Fruget and Persat, 2000; Baran and Compagnat, 2005).

145 Like most French large river ecosystem, the lower Saône contains species that have been voluntarily
146 or involuntarily introduced mostly from the 19th century onwards (Keith and Poulet, 2020).
147 Introduced species, such as Common carp (*Cyprinus carpio*), Pike-perch (*Sander lucioperca*), Brown
148 bullhead (*Ameiurus nebulosus*), Largemouth bass (*Micropterus salmoides*), Pumpkinseed (*Lepomis*
149 *gibbosus*) for fish, or Zebra mussel (*Dreissena polymorpha*) and Spinycheek crayfish (*Faxonius*
150 *(Orconectes) limosus*) for large invertebrates, are now considered as a part of the common
151 background of the species community. During the period under consideration, from 1988 to 2005,
152 there was a strong development of invasive or expanding species (IES) likely to have a major impact
153 on the functioning of the ecosystem. The great cormorant (*Phalacrocorax carbo*) has spread
154 southward, from the original Dutch and Danish nesting areas, and arrived in the Saône plain from
155 1997 (Marion and Bergerot, 2018). The European catfish (*Silurus glanis*) was introduced into the
156 basin in 1956. It began to breed only since 1968 in the Seille River, a tributary of the lower Saône
157 itself colonized in the 1980s, and accessed the entire Rhône watershed during the 1990s (Keith and
158 Poulet, 2020). The Asian clam *Corbicula fluminea* arrived in the lower Saône in 1990 from the
159 Garonne watershed via the Rhône river (Mouthon, 2000). While the causal link between this last
160 invasive species and the regime shift has been suggested by Mouthon (2001), it is only the role of
161 phytosanitary pollutants, as inhibitors of the development of phytoplankton, that has been
162 investigated to explain the transparencies (Fruget and Persat, 2000). However, the inhibitory role of
163 pollutants has not been definitively established (Fruget and Persat, 2008). Two invasive crustacean
164 species, *Chelicorophium curvispinum*, found since 1992 in river Saône (Genin, 1992) and
165 *Dikerogammarus villosus* found since 1997 (Bollache et al., 2004) must also be mentioned here. Even
166 if their numbers are large, they are considered to have less influence than Asian clam as attested in
167 other French large rivers (see Floury et al., 2013 for Loire and Bachman & Usseglio-Polatera, 1999 for
168 Mosel). The low habitat specificity and the intense filtering and breathing power of Asian clam affects
169 global respiration budget of the river (Bachman and Usseglio-Polatera, 1999; Minaudo et al., 2021).
170 In this study, we will adopt an ecosystem-based approach using a trophic model type EwE to quantify
171 the role of different IES in the ecosystem shift and their relative impact on the other species in
172 ecosystem flows in the lower Saône river.

173 **2 Materials and methods**

174 **2.1 Study area**

175 The Saône river (Fig. 1), the main tributary of the Rhône river, originates in the Vosges mountains
176 and flows north-south for 480 km to its confluence with the Rhône river in Lyon. Geologically, it is the
177 oldest river axis of the basin because the upper Rhône was connected later to its actual watershed,
178 at the end of Pleistocene (Persat et al. 2020). In its downstream part, after its confluence with the
179 Doubs at the city of Verdun-sur-le-Doubs, it receives no major tributaries and constitutes a
180 homogeneous water body, called the lower Saône (or Great Saône), which was occupied by a lake
181 during the Early Pliocene (Persat et al. 2020). This lake had generated a large sedimentary plain
182 which forms a dedicated hydro-ecoregion (Wasson et al. 2002; Fig. 1). Currently, the lower Saône has
183 a very low slope (on average 0.003%, sometimes less than 2 cm/km in flood), a water surface area of
184 3,297 ha (or 32.97 km² calculated for this study using QGIS v.2.18) and a linear length of 170 km. The

185 presence of this slow, productive river, positioned in the middle of the basin, is one of the major
186 singularities of the Rhône watershed.

187 The climate of the lower Saône region is humid semi-continental, with high temperatures in summer
188 and cold, rainy winters. The hydraulic regime of the Saône is still almost natural and follows this
189 seasonal variation with regular floods in winter (sometimes more than 1,400 m³/s) and extremely
190 low water levels (a few tens of m³/s) in summer. Current velocities are naturally very low (about
191 60 cm/s in flood, often less) and the floods are progressive and predictable (EPTB Saône-Doubs,
192 2016). The average annual water temperature is 13.5°C (Poirel et al., 2008).

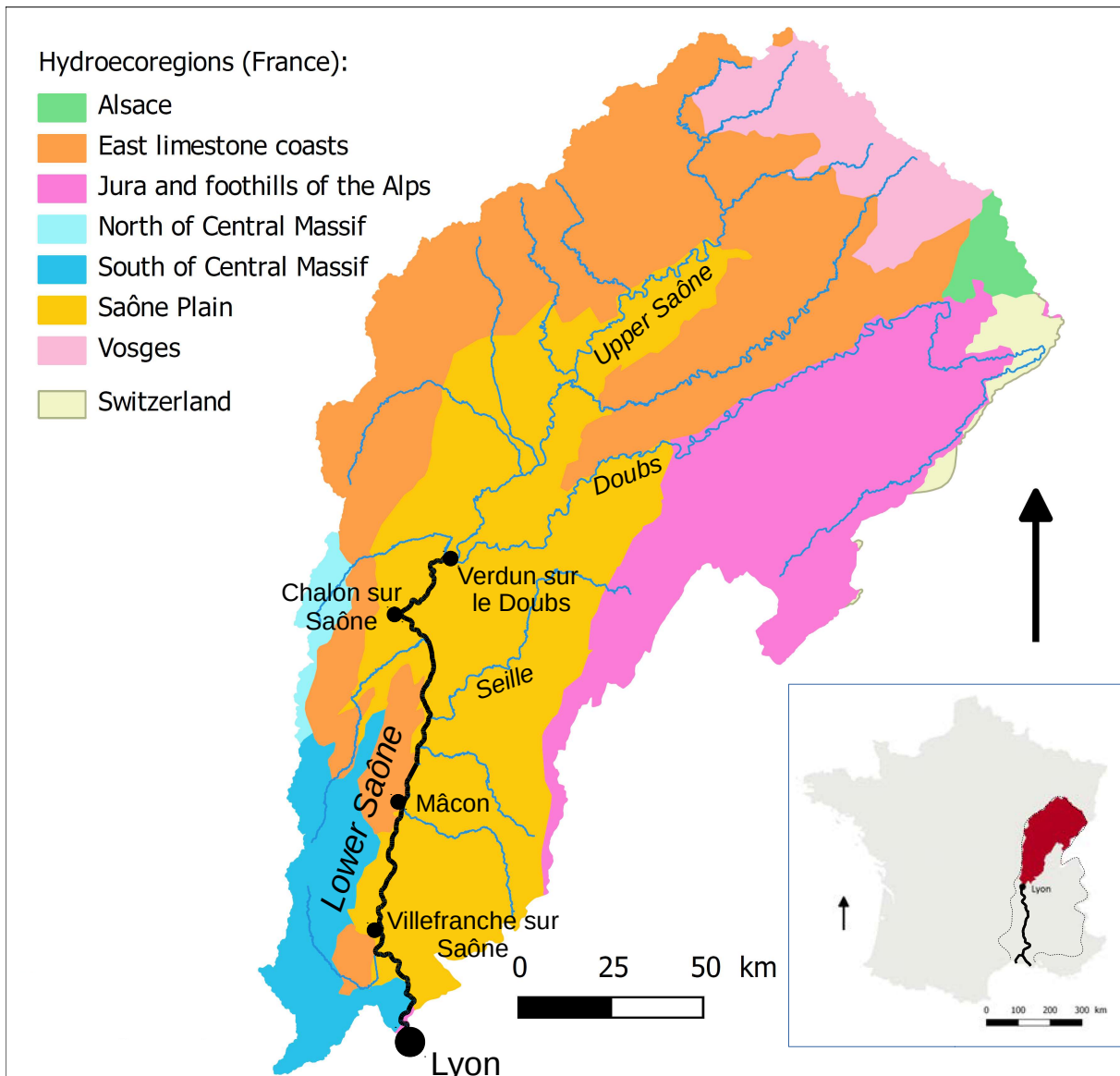

193
194 Fig. 1: Lower Saône position in the Saône River basin showing hydro-ecoregion according to Wasson
195 et al. (2002). Modified from hydro-ecoregion-IRSTEA, BD Carthage IGN, AE RMC.

196 2.2 Ecopath model

197 In the EwE suite we used the static module, Ecopath, dedicated to the construction and analysis of a
198 mass balance model that represents the ecosystem at a given period, as detailed in Christensen et al.
199 (2005). For this purpose, different functional groups, with similar feeding regimes, life history traits

200 and ecological behavior were identified. A single functional group can contain several species or a
201 single species.

202 Ecopath computed a mass balance so that the production of each prey is equal to or greater than the
203 sum of the biomass consumed by the predators plus the biomass captured by fisheries plus the
204 exports from the system.

205 The main equation used by Ecopath model is:

$$206 \quad P_i = \sum B_j \times M_{2ij} + Y_i + E_i + BA_i + P_i \times (1 - EE_i)$$

207 where P_i is the production of the functional group i , M_{2ij} is the predation of i by the predator j and B_j
208 its associated biomass, Y_i is the export by the fishery, E_i all the other types of export, BA_i the biomass
209 accumulation and EE_i the ecotrophic efficiency (i.e. the proportion of the production of group i that is
210 explained by the model, either by its exports or its predation). Thus, $(1 - EE_i)$ represents other
211 mortality, or mortality not explained in the system.

212 The previous equation can be rewritten as follows:

$$213 \quad B_i \times (P/B)_i = \sum B_j \times (Q/B)_j \times DC_{ij} + Y_i + E_i + BA_i + B_i \times (P/B)_i + (1 - EE_i)$$

214 with $(P/B)_i$ is the production per biomass unit, $(Q/B)_j$ is the consumption per biomass unit and DC_{ij} is
215 the portion of i in the diet of predator j .

216 For each functional group, Ecopath requires three among the following parameters: B , P/B , Q/B , and
217 EE . In most cases, we chose to let Ecopath calculate EE that must be less than 1 for the functional
218 group to persist in the ecosystem. It is this parameter that enabled us to identify estimation errors
219 and balance the model.

220 **2.3 Year of cleavage and fisheries data**

221 In order to represent in the best way possible the changes observed in the studied ecosystem in
222 relation with IES arrivals, two Ecopath models were built corresponding to two different equilibrium
223 situations of the ecosystem before (period 1) and after (period 2) the regime shift.

224 The two periods differ by the change in abundance of IES. To specify the year of cleavage between
225 the two periods to be considered, we used lower Saône annual catch estimates from the monitoring
226 system for professional and amateur gear fishers. Catch estimates were deduced from their annual
227 declaration multiplied by a return rate (no. of fishers declaring/no. of fishers admitted) calculated at
228 the sector's scale (see Changeux and Zylberblat 1993a, 1993b and
229 https://professionnels.ofb.fr/sites/default/files/pdf/snpe_2003-2012_201505.pdf for more details on
230 the methods). For the period from 1988 to 2005, the lower Saône appears to have the highest return
231 rate of the whole Rhône watershed. The fishers were asked to declare only the catches taken out of
232 the water. *There is therefore equality between landings and catches. By aggregating the catches
233 from different fishing gears used over the course of a year by amateurs and professionals, we can
234 consider that these data reflect a global activity that is not very selective.* Correspondence Analysis
235 (CA) of annual estimates of catches and a clustering procedure on Euclidian distance from Rstudio
236 (v.1.2.1335) packages FactomineR and factoextra were used to show the distribution between years
237 and make the partition into two periods.

238 To quantify the landings removed from the ecosystem by fishing, we must consider both fishing gear
239 users (professional and amateur) and anglers. For professional and amateur fishers, the mean values
240 of the previous annual catch estimates for each period were used. For anglers the only available

241 studies (Changeux (1996) for period 1 and Faure (2013) for period 2) were used. This last study only
242 covers two annual fishing seasons and does not take into account the releasing of the catches.
243 Considering the uncertainty on anglers' landings, the order of magnitude of the biomasses obtained
244 after calibration of the model were compared to the statistics concerning the annual number of tax
245 payments in the 3 departments concerned by the lower Saône River (Ain, Saône-et-Loire and Rhône)
246 as a fishing effort proxy.

247 **2.4 Functional groups and model parameters inputs**

248 Model functional groups were established according to a maximum of the following criteria and at
249 least two: (i) For a given species when it is specifically targeted by one or more categories of fishers;
250 (ii) The group must be sufficiently documented to estimate the model parameters. When several
251 species are grouped together, the parameters are established by taking a biomass-weighted average
252 of the species in the group; (iii) The group must constitute a significant biomass (at least 10%) of a
253 trophic level and related to the fishery landings. A low abundance species targeted by the fishery is
254 attached to a group to achieve 10%; (iv) The group must be homogeneous, with species having
255 similar P/B; (v) It must also include species with similar ecological and feeding behaviors; (vi) When a
256 species varies by more than 50% between periods, the species is individualized as a group.

257 In the following part of this section, we will explain how biomass (B), production/biomass ratio (P/B),
258 consumption/biomass ratio (Q/B) and diet composition (DC) have been assessed for each functional
259 group, going down the food chain from fish-eating birds to primary producers (phytoplankton and
260 macrophytes), and specify the criteria they meet with reference to the list given in 2.4

261 **2.4.1 Birds (*great cormorant*)**

262 The lower Saône is frequented by a large number of water birds (ducks, swans, waders, grebes,
263 Rallidae). Among the large fish-eating birds, the great cormorant has a special place because, in the
264 opinion of fishers as well as managers, it was rare during period 1 and very abundant during period 2
265 (criterion vi), with a considerable potential impact on the fish resource (criterion iii). That is why it is
266 the only bird species that is well documented (criterion ii).

267 Biomass of great cormorants was established using the results of the detailed local counts during
268 years 1989, 1992, 1999, 2001, 2003, 2005 provided by Loïc Marion, in charge of the national census
269 of the species (Marion, 2019). We took into account its spatial and temporal variations in the lower
270 Saône. For space variation we selected the dormitories located less than 10 km from the lower
271 Saône, and weighted the numbers by the proportion of water surface area accounted for the river
272 within this radius. For temporal variations, we used the average monthly presence ratio on the whole
273 time-series. Finally, the biomass was calculated with the average weight, male and female combined,
274 of 2.2 kg established by Fonteneau et al. (2009). P/B and Q/B ratios values were from Jorgensen
275 (2011), and diet composition adapted from Fonteneau et al. (2009).

276 **2.4.2 Fish**

277 Specially targeted by fisheries (criterion i), well-documented (criterion ii) and present at different
278 trophic levels (criterion iii), fishes constitute the core of our model.

279 The estimations of fish biomasses were established in consultation with all the authors including a
280 professional fisherman. The total biomass retained was 400 kg/ha (or 40 t/km²) as indicated by
281 Arrignon (1991) for type 3B large river ecosystem (Bream zone). For species distribution in the
282 biomass, we have preferred to use professional and amateur catch rather than electrofishing
283 because the various fishing gears they use sample the fishes of the entire body of water. This choice

284 was made after studying electrofishing sampling data of Office Francais de la Biodiversité on lower
285 Saône showing they underestimate the total biomass and favor species and young stages living in
286 shallow littoral shoreline habitats (Zajicek and Wolter 2018). To ensure that each group has a
287 meaningful contribution at its trophic level (criterion iii), rare species were grouped by
288 trophic/functional level. To meet criterion v (similar ecological and feeding behaviors), a Juvenile
289 group was created to include the very young stages of all fish (0 to 6 months), as in Mathews (1993).
290 P/B ratio is assimilated to total mortality rate (Z) related to natural mortality (M) and fishing
291 mortality (F) following $Z = M + F$. Natural mortality (M) was obtained from the empirical relation
292 (Palomares and Pauly, 1998):

$$293 \quad M = K^{0.65} \cdot L_{inf}^{-0.279} \cdot T_c^{0.463}$$

294 where K (/year) is the parameter of curvature of the Von Bertalanffy growth curve, L_{inf} (cm) is the
295 asymptotic total length of the same curve and T_c is the average water temperature of the study area
296 (13°C). For each fish species, the values of K and L_{inf} were collected in Fishbase (fishbase.mnh.fr).
297 The value chosen was from a river similar to the Saône, or if not indicated an average value. For
298 European catfish, the value of K was not available, so we used Britton et al. (2007). For the Juvenile
299 group, the P/B value was based on Janjua and Gerdeaux (2009). The fishing mortality F was obtained
300 by performing the yield/biomass ratio (Y/B) with Y equal to the quantity fished of the species
301 (t/year)/water surface (km²).

302 Q/B ratio was obtained according to the empirical relationship of Palomares and Pauly (1998):

$$303 \quad \text{Log}(Q/B) = 7.964 - 0,204 \cdot \log(W_{inf}) - 1.965 \cdot T_c + 0.083 \cdot A + 0,532 \cdot h + 0.398 \cdot d$$

304 where W_{inf} is the asymptotic weight (g), T_c is the average water temperature of the study area (13°C),
305 A is linked to the shape of the caudal fin of the species considered. It is calculated according to the
306 following relation $A = h^2/S$ (h: the height of the fin and S its surface). These values are available in
307 FishBase. Concerning h and d, these parameters express the nature of the diet. For h, its value is
308 equal to 1 when the species is herbivorous and 0 otherwise. Concerning d, its value is 1 for
309 detritivorous and 0 otherwise. Concerning the Juveniles, knowing their similarity with bleak, we used
310 the same Q/B as for this species.

311 The diets of each species were extracted from Fishbase in rivers comparable to the lower Saône.
312 Supplements were sought in the literature such as the inclusion of Asian clam in the diet of some
313 cyprinids (Robinson and Wellborn, 1988) and in the diet of European catfish (Vagnon, 2021). The
314 diets were averaged for grouped species and weight by their biomass fraction in the group.

315 **2.4.3 Zoobenthos**

316 Zoobenthos is a taxonomic group particularly consumed by fish (criterion iii). It is well documented
317 (criterion ii), as it is used to assess the quality of ecosystems. Some species, such as the spinycheek
318 crayfish (*Faxonius (Orconectes) limosus*), are targeted by fishing (criterion i) and/or show variations
319 greater than 50% between the two periods, such as the Asian clam (criterion vi). This has led us to
320 individualize a group for each of these two species in the model. To determine the other functional
321 groups we used the individual species counts from Fruget and Persat (2008) which refers to period 2.
322 We selected the species whose percentage of presence was higher than 10% (criterion ii). Then we
323 grouped them according to their similar P/B ratio (criterion iv) and to the similarity of their ecological
324 and feeding behavior (criterion v) using the literature (Table S2). The arrival of two invasive
325 invertebrates: the gammarid *Dikerogammarus villosus* in 1997 (Bollache et al., 2004) and the filter
326 collector *Chelicorophium curvispinum* in 1991-1992 (Genin, 1992), was taken into account in the

327 species lists for these groups. In accordance with the literature, it was considered that these arrivals
328 have mainly had an impact on the distribution of species within their trophic group.

329 The biomass of zoobenthos was calculated by the model, using the other known zooplankton
330 parameters available in Mathews (1993), except for Asian clam and spinycheek crayfish. The biomass
331 of Asian clam, absent in period 1, was however noted as being almost zero (biomasses at zero cannot
332 be entered in Ecopath). In period 2, it was calculated according to the method of Chesnais (2013)
333 with density data from the Mouthon (2003) study on the Saône. For the spinycheek crayfish, the
334 biomass was deduced from the contrasting situation of this resource between the two periods. In
335 period 2, crayfish are so intensively consumed by catfish that fishers have given up fishing for them.
336 Their period 1 biomass was therefore established from the consumption capacity of the European
337 catfish in period 2 given by the model. For the two periods, when it wasn't estimated by Ecopath,
338 P/Q and EE values were chosen from Mathews (1993) and P/B ratios were taken from the literature,
339 after grouping of the species (see Table S2 for more details). Diets were also extracted from the
340 literature (Briand et al., 2020; Chesnais, 2013; Evariste, 2016; Marguillier et al., 1998; Worischka et
341 al., 2018). Regarding spinycheek crayfish diet, P/B, P/Q and diet were taken from Hamr (2002) and
342 Vojtkovská et al. (2014).

343 **2.4.4 Plankton**

344 Although less crucial in rivers than in marine or lacustrine environments, plankton supports a
345 significant portion of the biomass (criterion iii) and serves as food for many fish, especially young
346 stages. In order to meet criteria iv (similar P/B values) and v (similar ecological and feeding
347 behaviors), it was segmented into zoo- and phytoplankton. The species were grouped into habitual
348 taxonomic groups (phylum, class, sub-order). The phytoplankton biomass values estimated using
349 existing studies on Saône River (Bourgeot et al., 2010; Fruget and Persat, 2008), Seine River (Gamier
350 et al., 1995) and extrapolations from chlorophyll *a* concentration, were too low. Finally, in the
351 absence of other biomass values available in a similar stream, zooplankton and phytoplankton
352 biomass were estimated at equilibrium for both periods by the model using the other known
353 zooplankton parameters (EE, P/B, Q/B) available in Mathews (1993). As for spinycheek crayfish, the
354 phytoplankton is singled out by the fact that in period 2, Asian clams reach the end of this resource
355 by creating transparencies. The biomass is thus sized by the consumption capacity of the Asian clam.
356 The zooplankton diet was based on the study by Chesnais (2013).

357 **2.4.5 Macrophytes and periphyton**

358 Aquatic plants (macrophytes) and algae attached to rocks and aquatic plants (periphyton) represent
359 significant biomasses among primary producers in flowing waters (criterion iii). In order to meet
360 criteria iv and v (similar P/B values and similar ecological and feeding behaviors), they each form a
361 separate group in our model. For species composition of these two groups we used Fruget and Persat
362 (2008) results regarding occurrence. Biomass estimates from the few studies were very low. For
363 macrophytes we used the order of magnitude available in Welcomme (1985). For periphyton we let
364 Ecopath estimate EE from other available parameters (B, Q/B).

365 **2.4.6 Detritus**

366 Detritus biomass was calculated from the following empirical formula (Christensen et al., 2005):

$$367 \text{Log}(D) = 0.954 * \text{log}(P_p) + 0.863 \text{log}(E) - 2.41$$

368 With P_p : primary production and E: depth of the euphotic zone (2 m).

369 Since the chlorophyll concentrations are similar to those of the lower Saône, the average primary
370 production used in our model is that of the portion of the Seine studied by Gamier et al. (1995). The
371 unit being mgC/m²/year, the global conversion factor for phytoplankton used is that of O'Reilly and
372 Dow in Link et al. (2006).

373 **2.5 Model calibration**

374 The model was calibrated manually by adjusting first the landings of the anglers and then the group
375 inputs, to obtain EE values lower than 1 and a P/Q ratio ranging from 0.05 to 0.3 in accordance with
376 Christensen et al. (2005). For the anglers' landings, we adjust the values taking into account the catch
377 and release and the fishing effort. For the groups, we started with the group having the highest EE
378 until it dropped below 1 and then skipped to the next highest EE group. We changed first the diet
379 composition, in relation with the availability of prey, then the biomass, considering first the least
380 reliable parameters. The results of the model were validated, in a collegial way, by all authors,
381 experts in the different trophic groups. The data for this model was assigned an Ecopath Pedigree Index of
382 0.45 (Table 3), close to other published models (Janjua and Gerdeaux, 2009; Chesnais 2013).

383 **2.6 Model outputs**

384 Among the different output tools proposed by Ecopath, we have selected two indexes. First the
385 keystone index of Valls et al. (2015) was used to designate functional groups whose small biomass
386 variations have a high impact on the organization of the ecosystem. Secondly, the Mixed Trophic
387 Impact index of Ulanowick and Puccia (1990) was used to study the impact of direct and indirect
388 interactions. To show the flows between trophic levels and detritus, we also used the diagram
389 associated with Lindeman spine function. The overall statistics, including the pedigree index, were
390 also used to summarize our results and make an overall comparison with other references.

391 **3 Results**

392 **3.1 The two periods through fisheries data**

393 The annual catches time-series of fishing gear users (sum of professionals and amateur) are grouped
394 according to the catch categories specified in Table 1. The Correspondence analysis biplot of these
395 data includes 89.5% of inertia (Fig. 2). Result shows a progression from 1988 to 1993, and a clustering
396 of two groups of years (1988-1993 and 1994-2005). Period 1 (1988-1993) is associated with spiny
397 cheek crayfish and brown bullhead, while period 2 (1994-2005) is associated with European catfish.
398 The number of fishing days and fishers are similar (P bilateral t test > 0.05) with a mean value of
399 1,641±385 d/y for 19±4 professionals and 3,189±989 d/y for 174±29 amateurs. The catches of
400 professionals slightly increase while those of amateurs decrease (P unilateral t test = 0.003) and their
401 total mean values were 74±11 t/y (or 2.2±0.33 t/km²/y).

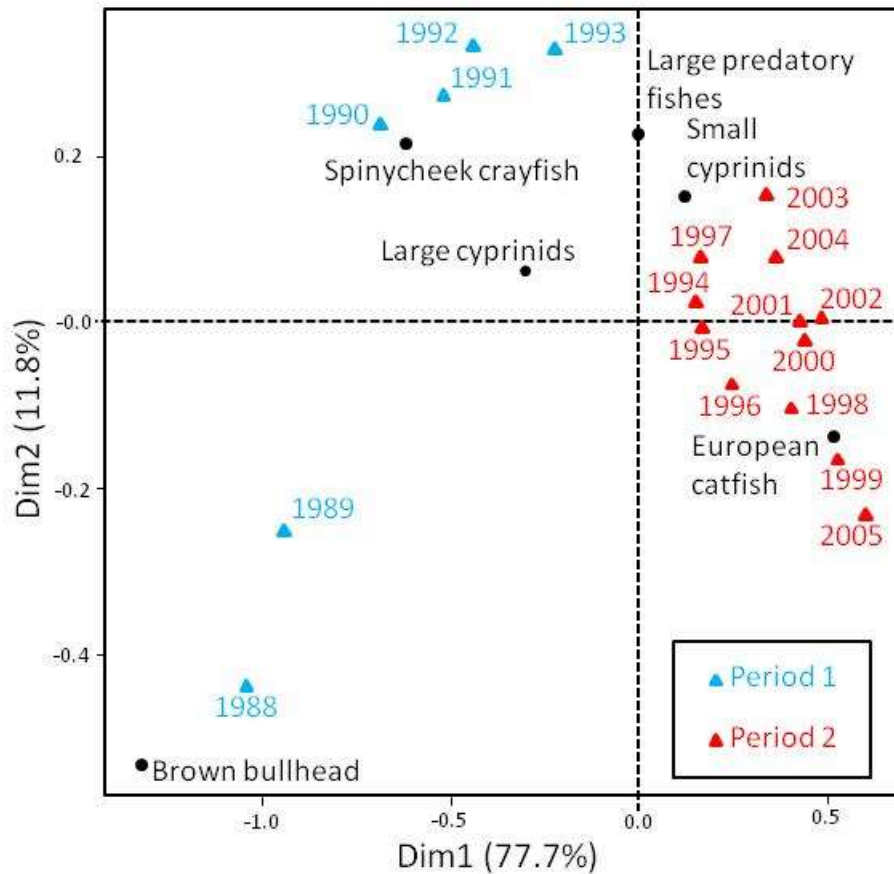

402
 403 Fig 2: Correspondence analysis biplot of the fishing gear users' catches annual time-series from 1988
 404 to 2005 with the catch categories (black circles) given in Table 1. Years are figured by triangles.
 405 Period 1 (1988-1993), in blue, and period 2 (1994-2005), in red, are obtained by clustering.

406 A first estimate of the catches of the anglers shows a decrease from 18.3 t/km²/year for period 1 to
 407 0.95 t/km²/year for period 2. For period 1, the initial estimate of anglers' landing had to be divided by
 408 4 to adjust for the production capacity of the river, giving a total equal to 4.9 t/km²/year. For
 409 period 2, by making the adjustment, the overall landing increases from 0.95 t/ km²/year to
 410 1.2 t/km²/year. If the two periods are compared, this corresponds to a decrease of 75% in the
 411 landings by anglers between period 1 and 2, which is quite consistent with the evolution of fishing
 412 effort considering tax payments.

413 From these different landing estimates, detailed in Table S3, it can be concluded that the global catch
 414 decrease from 7.2 t/km²/year, during period 1, to 3.4 t/km²/year, during period 2, is principally due
 415 to the decrease in the number of anglers.

416 3.2 Model basic input and resulting estimate for the two periods

417 The application our criteria to the lower Saône ecosystem led to the distinction of 28 functional
 418 groups plus detritus detailed in Table 1. Most of them (17) are monospecific with a dedicated group
 419 for each identified IES. Each of these groups can be linked to a catch category of the monitoring
 420 system. The model constitutes a coherent set to realize an ecosystem based approach of the lower
 421 Saône.

422

423 Table 1: Distribution of species or taxa according to their functional group in the model, catch
 424 category in the statistics, and their related compartment in the ecosystem (in bold with*: invasive or
 425 expanded species). The percentage gives biomass proportion of species in multi-specific groups.

Ecosystem compartment	Catch category	Functional group	Species or taxa
Bird	Not fished	1-Great cormorant*	<i>Phalacrocorax carbo</i>
Carnivorous fish	Large predatory fishes	2-Pike-perch	<i>Sander lucioperca</i>
		3-Northern pike	<i>Esox lucius</i>
		4-Other carnivorous	<i>Perca fluviatilis</i> (97%), <i>Micropterus salmoides</i> (3%)
		5-European catfish*	<i>Silurus glanis</i>
Omnivorous fish	European catfish*	6-Brown bullhead	<i>Ameiurus nebulosus</i>
Insectivorous fish (water column feeders)	Small cyprinids	7-Bleak	<i>Alburnus alburnus</i>
		8-Juvenile fish	All species 0+ less than 6 months
		9-Other insectivorous	<i>Thymallus thymallus</i> (50%), <i>Phoxinus phoxinus</i> (26%), <i>Telestes souffia</i> (24%)
Benthivorous fish	Large cyprinids	10-Barbel	<i>Barbus barbus</i>
		11-Chub	<i>Squalius cephalus</i>
		12-Common carp	<i>Cyprinus carpio</i>
		13-Tench	<i>Tinca tinca</i>
		14-Roach	<i>Rutilus rutilus</i>
		15-Breams	<i>Abramis brama</i> , <i>Blicca bjoerkna</i>
		16-Other benthivorous	<i>Anguilla Anguilla</i> (44%), <i>Scardinius erythrophthalmus</i> (22%), <i>Lepomis gibbosus</i> (16%), <i>Carassius carassius</i> (7%), <i>Lota lota</i> (6%), other $\geq 5\%$ (5%)
Herbivorous fish		17-Common nase	<i>Chondrostoma nasus</i>
		18-Silver carp	<i>Hypophthalmichthys molitrix</i>
		19-Grass carp	<i>Ctenopharyngodon idella</i>
Zoobenthos	Spinycheek crayfish	20-Spinycheek crayfish	<i>Faxonius (Orconectes) limosus</i>
		21-Gammarus	<i>Gammarus pulex</i> , <i>Gammarus fossarum</i> during period 1. <i>Dikerogammarus villosus</i> during period 2
	Not fished	22-Other scraper collectors	<i>Tubifex tubifex</i> (57%), <i>Chironomini</i> (43%)
		23-Asian clam*	<i>Corbicula fluminea</i>
Plankton	Not fished	24-Other filter collectors	<i>Dreissena polymorpha</i> (60%), <i>Chelicorophium curvispinum</i> (40%) during period 2 only
		25-Zooplankton	Copepods (44%), rotifers (43%), Cladoceres (13%)
Benthic primary producers	Not fished	26-Phytoplankton	Diatoms (46%), Cryptophyceae (43%), Chlorophyceae (9%), Other (2%)
		27-Macrophytes	<i>Myriophyllum spicatum</i> (18%), <i>Nuphar lutea</i> (14%), <i>Ceratophyllum demersum</i> (10%), <i>Poramogeton nodosus</i> (8%), <i>Valisneria spiralis</i> (6%), other $\geq 5\%$ (44%)
		28-Periphyton	<i>Achnanthes minutissima</i> (22%), <i>Amphora pediculus</i> (15%), other $\geq 5\%$ (63%)
Detritus	Not fished	29-Detritus	

426 Table 2: Basic input and estimated (in bold) trophic level (TL) biomass (B), production/biomass ratio (P/B), consumption/biomass ratio (Q/B),
 427 unassimilated/consumption ratio (U/Q) and ecotrophic efficiency (EE) of the model for periods 1 and 2 (*: for invasive or expanded species).

Group name	Period 1 (1988-1993)							Period 2 (1994-2005)								
	TL	B1 (t/km ²)	P/B (/year)	Q/B (/year)	U/Q (/year)	EE1	P/Q (/year)	TL	B2 (t/km ²)	P/B (/year)	Q/B (/year)	U/Q (/year)	EE2	P/Q (/year)	B2-B1 (t/km ²)	EE2-EE1
1-Great cormorant*	3.90	0.01	0.32	4.23	0.2	0.00	0.07	4.08	0.03	0.32	4.23	0.2	0.00	0.07	0.02	
2-Pike-perch	3.86	2.13	0.42	2.63	0.2	0.77	0.16	3.86	2.13	0.42	2.63	0.2	0.95	0.16	0.00	0.19
3-Nothern pike	3.85	0.80	0.39	2.80	0.2	0.99	0.14	3.79	0.73	0.39	2.80	0.2	0.97	0.14	-0.07	-0.01
4-Other carnivorous	3.70	0.34	0.70	5.30	0.2	0.90	0.13	3.72	0.40	0.70	5.30	0.2	0.87	0.13	0.06	-0.03
5-European catfish*	3.85	0.27	0.39	1.40	0.2	0.95	0.28	3.42	12.00	0.39	1.40	0.2	0.73	0.28	11.73	-0.22
6-Brown bullhead	3.20	0.67	0.84	4.30	0.2	0.60	0.20	3.10	0.09	0.87	4.30	0.2	0.91	0.20	-0.58	0.31
7-Bleak	3.04	4.80	0.96	7.80	0.3	0.98	0.12	3.04	4.80	0.97	7.80	0.3	0.63	0.12	0.00	-0.35
8-Juveniles	2.89	1.20	3.00	10.00	0.3	0.97	0.30	2.89	1.20	3.00	10.00	0.3	0.99	0.30	0.00	0.02
9-Other insectivorous	3.26	0.002	1.03	7.40	0.2	0.30	0.14	3.26	0.002	1.04	7.40	0.2	0.68	0.14	0.00	0.37
10-Barbel	3.05	0.87	0.16	9.30	0.2	0.96	0.02	3.05	0.89	0.17	9.30	0.2	0.98	0.02	0.02	0.02
11-Chub	2.52	2.59	0.30	11.30	0.2	0.92	0.03	2.51	0.89	0.30	11.30	0.2	0.92	0.03	-1.70	0.00
12-Common carp	2.24	3.75	0.38	8.10	0.3	0.68	0.05	2.23	4.85	0.39	8.10	0.3	0.89	0.05	1.10	0.21
13-Tench	2.95	1.44	0.27	8.90	0.2	0.96	0.03	2.95	0.53	0.27	8.90	0.2	0.99	0.03	-0.91	0.04
14-Roach	2.98	5.20	0.45	4.40	0.2	0.91	0.10	2.98	3.05	0.46	4.40	0.2	0.98	0.10	-2.15	0.06
15-Breams	2.96	14.40	0.30	13.90	0.2	0.91	0.02	2.92	7.73	0.31	13.90	0.2	0.99	0.02	-6.67	0.08
16-Other benthivorous	3.07	0.58	0.41	7.60	0.2	0.95	0.05	3.07	0.19	0.41	7.60	0.2	0.88	0.05	-0.39	-0.07
17-Common nase	2.00	1.00	0.39	13.50	0.2	0.52	0.03	2.00	0.56	0.39	13.50	0.2	0.88	0.03	-0.44	0.36
18-Silver carp		Absent			0.2			2.00	0.06	0.67	9.70	0.2	0.79	0.07	0.06	
19-Grass carp		Absent			0.2			2.00	0.11	0.32	8.36	0.2	0.66	0.04	0.11	
20-Spinycheek crayfish	2.32	2.50	1.40	7.00	0.6	0.20	0.20	2.31	2.50	1.40	7.00	0.6	0.95	0.20	0.00	0.76
21-Gammarus	2.25	9.00	2.50	12.50	0.2	0.92	0.20	2.25	9.00	2.50	12.50	0.2	0.46	0.20	0.00	-0.46
22-Others scrapers collectors	2.25	6.00	25.00	166.67	0.6	0.80	0.15	2.25	6.00	25.00	166.67	0.6	0.50	0.15	0.00	-0.30
23-Other filter collectors	2.37	23.10	3.60	24.00	0.4	0.80	0.15	2.37	23.10	3.60	24.00	0.4	0.28	0.15	0.00	-0.52
24-Asian clam*		Absent			0.4			2.00	8.50	2.89	19.27	0.4	0.91	0.15	8.50	
25-Zooplankton	2.00	15.00	37.40	249.33	0.4	0.95	0.15	2.00	15.00	37.40	249.33	0.4	0.96	0.15	0.00	0.01
26-Phytoplankton	1.00	27.00	95.30		0	0.91		1.00	27.00	95.30		0	0.96	0.00	0.05	
27-Macrophytes	1.00	52.00	4.40		0	0.76		1.00	52.00	4.40		0	0.75	0.00	-0.02	
28-Periphyton	1.00	13.00	47.70		0	0.29		1.00	13.00	47.70		0	0.26	0.00	-0.02	
29-Detritus	1.00	8.32			0	0.73		1.00	8.32			0	0.73	0.00	0.00	

428 The different input and estimated parameters for periods 1 and 2 are presented in Table 2. The diet
429 compositions are given in Table S4A and S4B.

430 The highest biomass variations concern the European catfish (+11.73 t/ km²) and the Asian clam
431 (+8.5 t/ km²) while that of the great cormorant does not vary as much (+0.02 t/ km²). These strong
432 increases in biomass is compensated by a decrease for breams (-6.67 t/ km²), roach (-2.15 t/ km²)
433 and chub (-1.7 t/ km²) since the total biomass, excluding detritus, only varies from 187.7 t/ km² to
434 196.3 t/ km² (Table 3) and the repartition between trophic level remains relatively stable (Table S5).

435 Our results are characterized by high Ecotrophic Efficiency (EE) values (mean±SD = 0.8±0.2) with
436 overall no significant difference between period 1 and 2 (P bilateral t test > 0.05). If we compare the
437 groups present during the two periods, fished groups EE values (0.8±0.2) are higher than non-fished
438 EE values (0.6±0.2) (P unilateral t test = 0.01). If we focus on EE variations in a given group, in the last
439 column of Table 2, the most contrasted differences are:

- 440 - the increasing EE values for spinycheek crayfish (+0.76), as a consequence of the increasing
441 biomass of European catfish, which is a major predator of this species,
- 442 - the decreasing EE values for other filter collectors (-0.52) is probably related to the
443 decreasing biomass of their predators: breams, roach, chub and other benthivorous species.

444

445 Comparison of the two diagrams in Figure 3 enables us to visualize the variations in biomass and
 446 trophic level of the groups and fisheries. It highlights the arrival of the Asian clam in the lower
 447 intermediate TL (2.00) and the European catfish in the high TL (>3), while the increase in biomass of
 448 the great cormorant is not very visible. The European catfish TL decreases from 3.85 to 3.42. The
 449 decrease in anglers' catches biomass is clearly visible without any change in their TL. Biomasses of
 450 intermediate species ($2 < TL < 3$), having high values in period 1, are generally decreasing (breams,
 451 roach, chub) while, in accordance with our original assumption, biomasses of low TL are unchanged

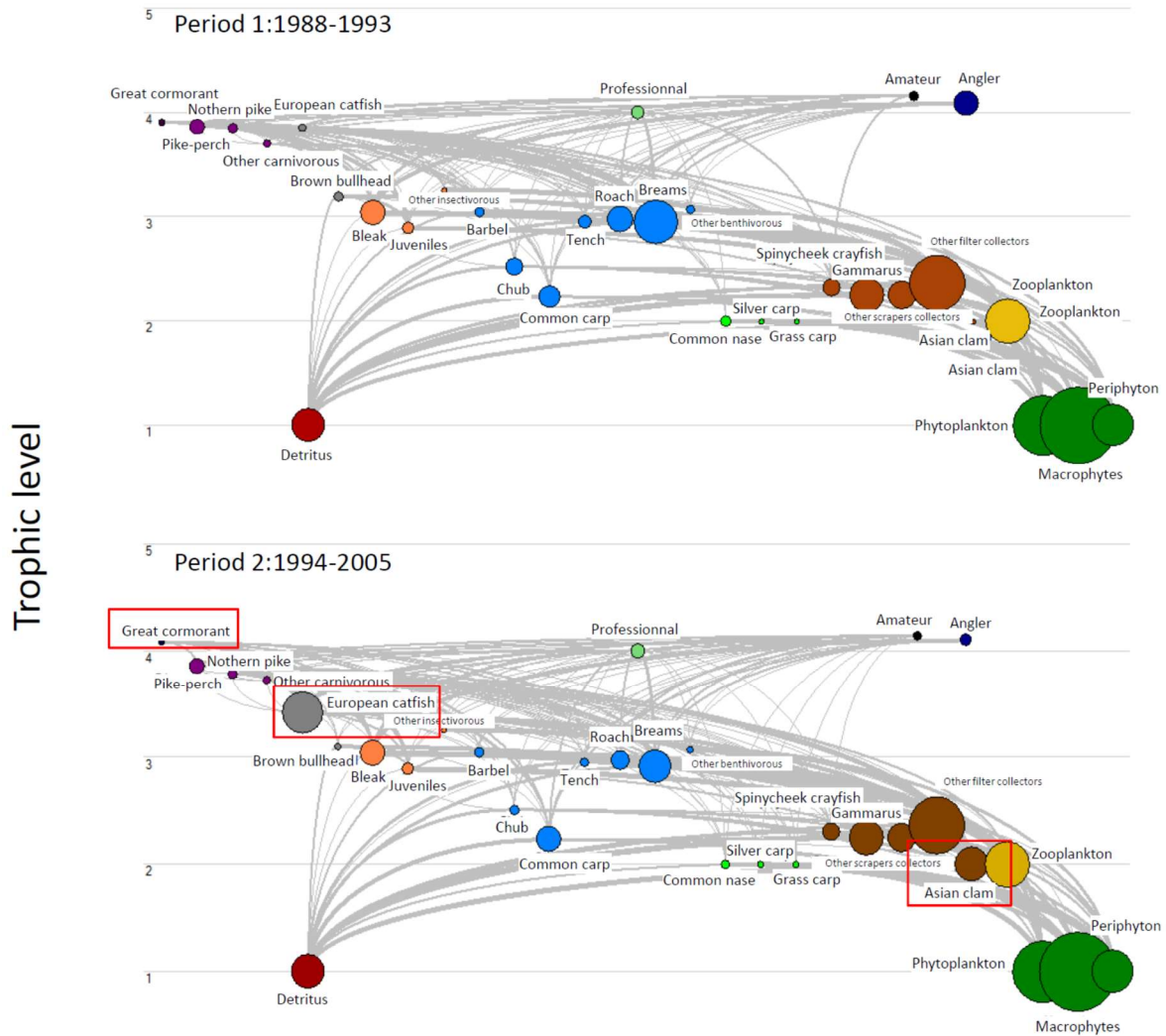

452
 453 Fig. 3: Lower Saône trophic network before (period 1) and after (period 2) the arrival of invasive or
 454 expanded species (great cormorant, European catfish and Asian clam, framed in red). Vertical axis
 455 indicates the trophic level. Circles are proportional to biomass and various colors correspond to the
 456 ecosystem part of each group following Table 1.

457 The visualization of the Keystone index, Fig. 4, shows that it is not systematically the groups located
 458 at the top of the trophic chain, nor the highest biomasses, that influence the network. For example,
 459 the periphyton and other scrapers collectors (chironomids and tubifex) are in the high impact ranks,
 460 while they have medium biomasses. They are preferential resources of the network, through which a
 461 significant trophic flow passes. The main variations between the two periods concern the arrival of
 462 the Asian clam among the species with a high index and the increase of the index of European catfish
 463 and spinycheek crayfish.

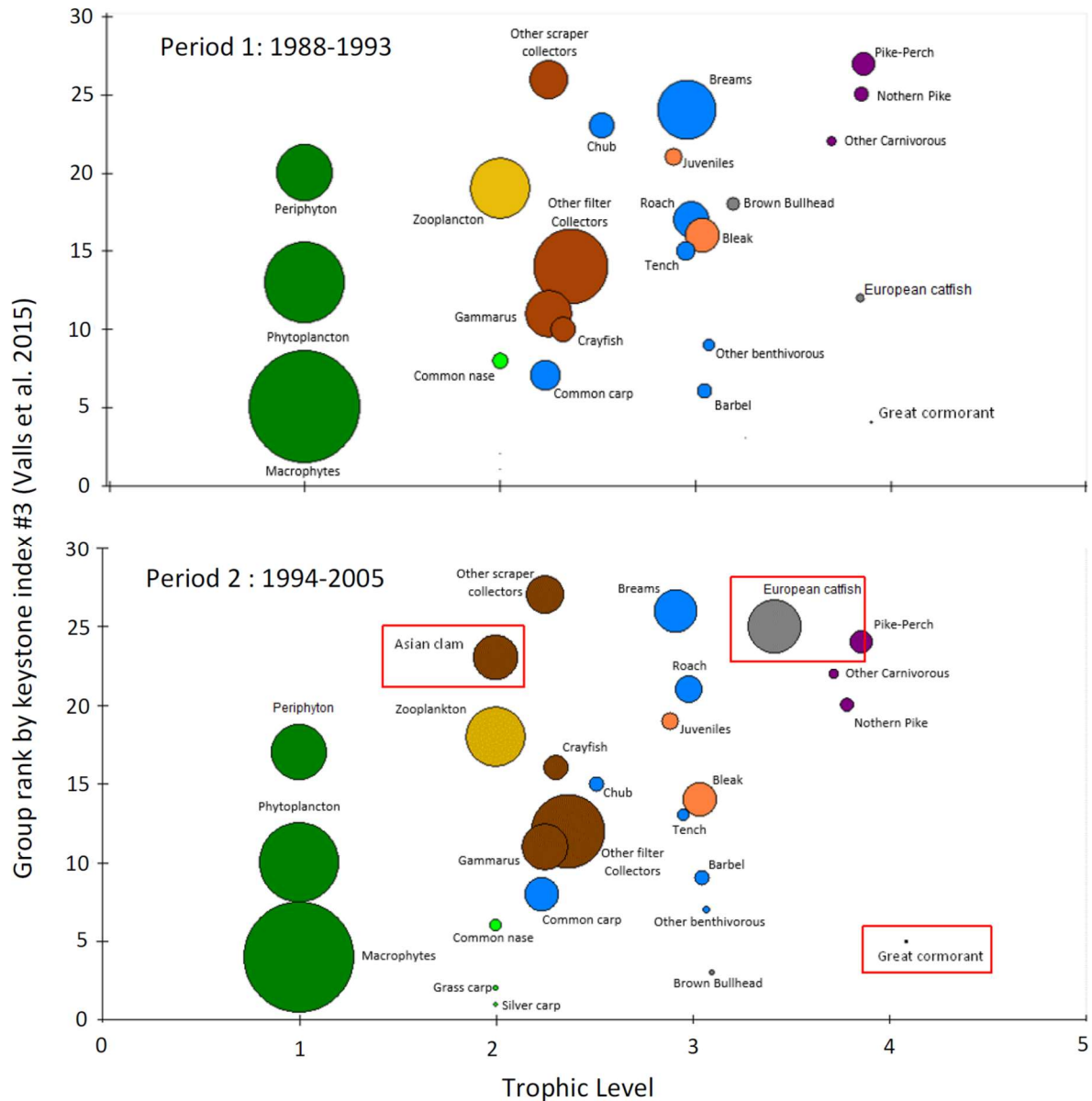

464
 465 Fig. 4: Keystone index from Valls et al. (2015) for the two periods as a function of trophic Level (TL).
 466 Circles are proportional to biomass and various colors correspond to the ecosystem part of each
 467 group following Table 1. Invasive or expended species (great cormorant, European catfish and Asian
 468 clam are framed in red.

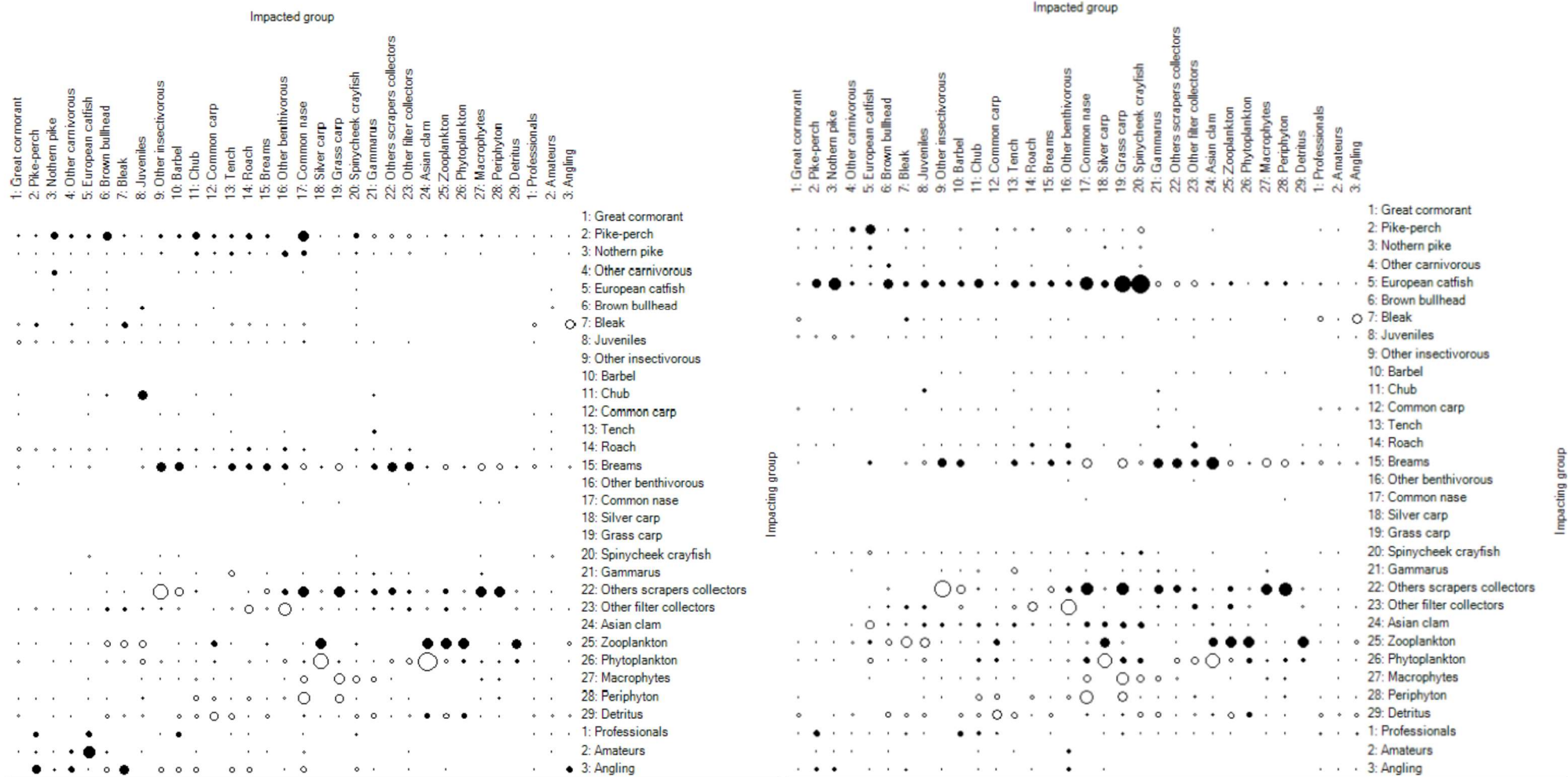

469

470 Fig. 5: Mixed trophic impact diagrams for period 1 (left) and period 2 (right) showing respective negative (in black) and positive (in white) impact of
471 functional groups and different categories of fisheries.

By comparing the Mixed trophic diagrams between the two periods (Fig. 5), we measure the negative impact of European catfish on all fish and spinycheek crayfish during period 2. Among carnivorous fishes, pike-perch and northern pike have less negative effect during period 2. The impact of lower groups remains the same from one period to another. Only the arrival of Asian clam brings a new slight negative impact on most of the groups except for the European catfish.

The comparison of the fluxes between TLs (Fig. 6), shows some changes between the two periods. They concern the 41% decrease of the transfer from TL III to TL IV (66.45 in period 1 vs 38.60 in period 2) accompanied by a division by two in exports and catches at all TL, to be related to the decrease in anglers' landings, during period 2.

The overall statistics for the two periods (Table 3) confirm that the main parameters characterizing the lower Saône do not vary much except the catches, decreasing from 7.2 to 3.4 t/km²/year, and consequently the fishery gross efficiency from 0.002 to 0.001. The total system throughput, proportional to the maturity and nutrient richness of the ecosystem, slightly increases and reaches 12,576.0 t/km²/year in period 2.

Table 3: Overall statistics of lower Saône model for the two periods and for three examples (Natural channel, Reservoir and Below reservoir) from the Red River (Wang et al. 2017).

Parameter	Our study		Wang et al. 2017			Units
	Period 1	Period 2	Natural channel	Reservoir	Below reservoir	
Sum of all consumption	5,808.3	5,858.4	1,015.7	5,628.8	743.9	t/km ² /year
Sum of all exports	889.7	908.6	512.4	212.7	1,712.3	t/km ² /year
Sum of all respiratory flows	2,532.3	2,513.4	339.6	3,567.3	129.8	t/km ² /year
Sum of all flows into detritus	3,250.0	3,295.6	969.7	2,897.8	2,040.1	t/km ² /year
Total system throughput	12,490.3	12,576.0	2,837.4	12,306.6	4,626.1	t/km ² /year
Sum of all production	4,262.5	4,287.8	1,003.0	4,715.8	1,967.1	t/km ² /year
Mean trophic level of the catch	3.07	3.06				
Gross efficiency (catch/net p.p.)	0.002	0.001				
Calculated total net primary production	3,422.0	3,422.0	852.0	3,780.0	1,842.0	t/km ² /year
Total primary production/total respiration	1.4	1.4	2.5	1.1	14.2	
Net system production	889.7	908.6	512.4	212.7	1,712.3	t/km ² /year
Total primary production/total biomass	18.2	17.4	10.7	32.3	38.8	
Total biomass/total throughput	0.015	0.016	0.028	0.010	0.010	
Total biomass (excluding detritus)	187.7	196.3	79.6	117.0	47.5	t/km ²
Total catch	7.2	3.4				t/km ² /year
Connectance Index	0.22	0.25	0.30	0.31	0.29	
System Omnivory Index	0.20	0.19	0.04	0.14	0.09	
Ecopath Pedigree Index	0.45	0.45				

Period 1: 1988-1993

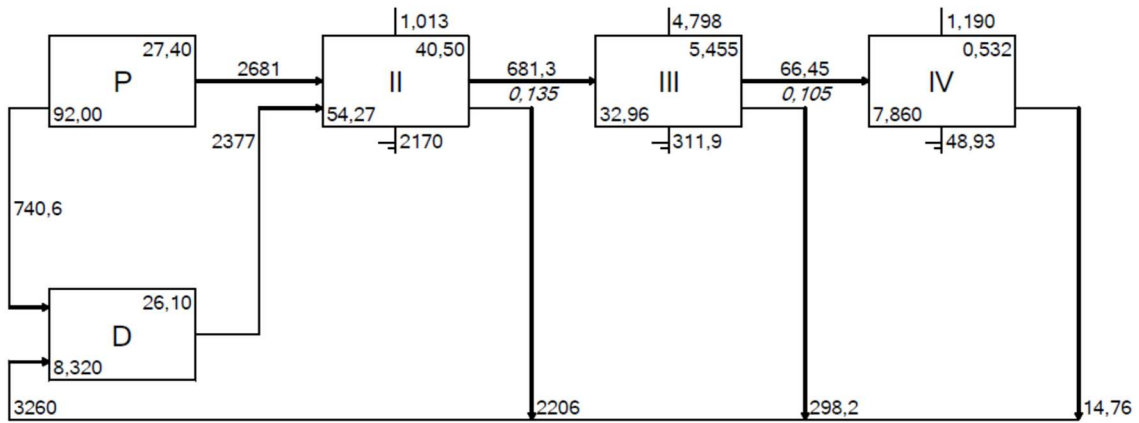

Period 2: 1994-2005

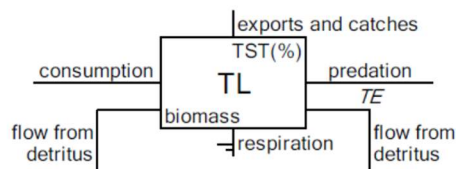
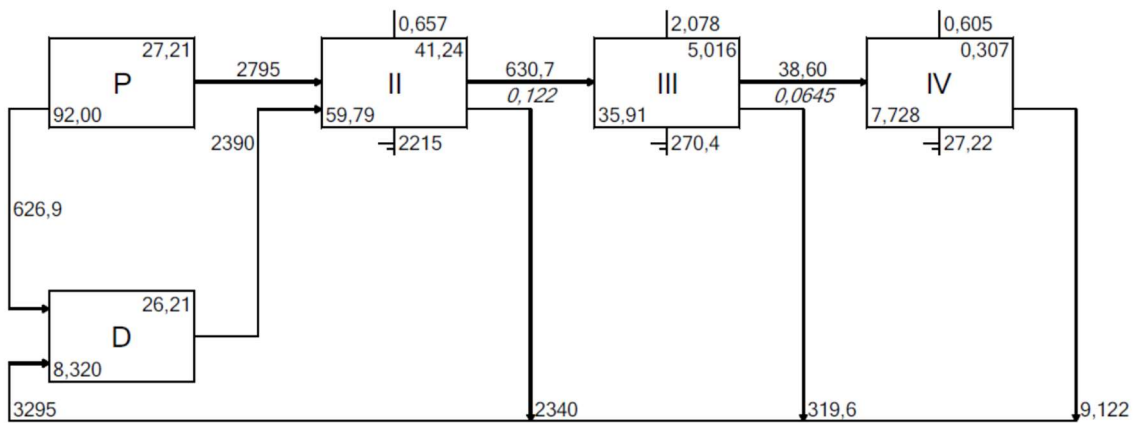

Fig. 6: Lindeman spine diagram of lower Saône model up to fifth trophic level. P: primary producer, D: detritus, TST: total system throughput, TE: trophic efficiency.

4 Discussion

4.1 Reconstruction of lower Saône river ecosystem by the model

The comparison of our results on biomasses and flux, in absolute values, with other studies conducted in freshwater hydrosystems places our study above oligotrophic coldwater lakes, such as Lake Annecy (Janjua and Gerdeaux, 2009), or large rivers such as the Garonne (Palomares et al., 1993) or the Upper Parana (Angelini and Agostinho, 2005), but below the Middle and Upper Mississippi (Kramer et al., 2019). Our total system throughput is of the same order of magnitude as the channel reservoir of the Red river given in Table 3 for comparison (Wang et al., 2017). This confirms that the lower Saône is a very productive ecosystem. It also enables us to reconsider the estimates of anglers' catches from Changeux (1996), which clearly exceeded the possible production

of such a system at equilibrium. High EE values for many species make the ecosystem more unstable (Dickie, 1972 in Janjua and Gerdeaux, 2009) and therefore subject to regime shift. The total primary production/total respiration of 1.4 is over 1 which means there is only a limited quantity of organic matter imported by the river and the ecosystem can be considered as “mature” *sensus* Odum. This is consistent with the results of Seyer et al. (2023). Taking into account the origin of the different input data and their reliability, the calculation of the Ecopath Pedigree Index results in a value of 0.44, similar to that of other studies in rivers (Chesnais, 2013; Lemaire et al., 2020).

4.2 *The ecosystem shift and influence of invasive or expanded species*

The similarity observed between the two periods is related to the assumptions we have made and that limit the sources of variation. The main hypothesis concerns the biomass of phytoplankton estimated on the basis of the consumption by the Asian clam. The value obtained of 27 t/km² is above that of the Garonne (6.73 t/km² in Palomares et al., 1993) but within the range of the Red River (between 14.2 and 63 t/km² in Wang et al., 2017). The hypothesis of a decrease in the biomass of phytoplankton, related to other forcing factors, such as nutrient concentration decrease, is not integrated in our model. In fact, large-scale observations made in the French rivers with a slight time lag compared to our study (1994-2013 vs 1988-2005), show a rearrangement of the communities to the disadvantage of phytoplankton in relation with a decrease of the concentration in nutriment (Tison-Rosebery et al., 2022). On the Loire River, a 30-year study (1991-2019) of nutrient concentration and biomass records of phytoplankton and cyanobacteria details this same trend for a large river (Minaudo et al., 2021). It suggests that the decline in phytoplankton and cyanobacteria is related to the decline in phosphate concentration. But in addition, as Pigneur et al. (2014) also conclude on the River Meuse, it makes clear the link with the arrival of the Asian clam. In the extension of this global River Loire study, a more detailed study focused on the river section of the middle Loire shows a very similar regime shift to the one observed on the lower Saône in the mid 1990s, but with a later changing point, between 2002-2005 (Diamond et al., 2021). If the latter study retains the river metabolism as an early warning indication of state shift, the Loire River shift also corresponds to a later arrival of the Asian clam (Mouthon, 2000). This time lag, and the positioning of the Asian clam among the species with a high keystone index in the lower Saône, suggests that this species must have had a triggering effect on the regime shift.

The two other IES are positioned in the higher trophic levels but do not have the same impact. In our model, the great cormorant has a slight top-down effect because of its low biomass relative to the resource it consumes. This is true even during period 2, after the species has fully completed its expansion. This result is consistent with the literature (Ovegård et al., 2021). In another similar large river, the Meuse, it has even been shown that it is the abundance of fish that controls the cormorant population in a bottom-up process (Paquet et al., 2022). The European catfish, on the contrary, reaches in period 2 a very high biomass value that places the species in the high keystone index with a significant negative impact on most fish species, spinycheek crayfish and Asian clam. This solicitation explains the rise in EE and keystone index of spinycheek crayfish and the strong keystone index of the Asian clam. The European catfish is known to be an opportunistic predator whose young stages (below 80 cm) target macrobenthos such as crayfish and filter-feeding molluscs before adopting a more piscivorous diet (Copp et al., 2009; Vagnon, 2021). The decreasing trophic level observed for European catfish between the two periods is well explained by the observations of fishers. In period 1, they caught large pioneer individuals that were more piscivorous while in period 2, once the population was well established, all sizes were represented in the catches

including the young stages that feed on spiny crayfish and Asian clams. More recent observations from anglers on European catfish show that the European catfish biomass has certainly decreased since 2005 and that period 2 corresponds to a population maximum. Therefore, period 2 corresponds to a population maximum with an exacerbated impact compared to the current situation.

4.3 *Including the fisheries in the ecosystem*

The fishery gross efficiency values (0.002 for period 1 and 0.001 for period 2) are low but comparable to nearby hydrosystems such as Lake Annecy (Janjua and Gerdeaux, 2009) and Lake Geneva (Lemaire et al., 2020). In qualitative terms, catches are much more diversified than in these two peri-alpine lakes where only a few species are targeted. But they are all situated at a close mean TL, around 3, regardless of the category of fishers and the period. The strong impact of the fishery during period 1 is later replaced by the even stronger impact of the development of European catfish population during period 2. Although the impact of catfish is more distributed between high and low TL than fishing, which leads to a decrease of the flows in III and IV TL, the high EE values show there is not much room for additional fishing pressure in either period.

4.4 *Prospects for improving the model*

The scarcity of data on the lower Saône has led us to formulate important hypotheses on the basis of the fishers' knowledge, as did Rosa et al. (2014). In addition we have completed our approach with results obtained on other ecosystems published in the literature. Many assumptions remain to be validated with field data to be collected on the lower Saône River. The biomass assessment will need further development to enable us to revise our hypothesis for primary producers and detritus in order to take into account nutrient variations. The fish biomass, specially detailed by our model, should be examined in the light of new field data, independently of the catches. A preliminary comparison with electrofishing and gill-net samples recently obtained from the Office Français de la Biodiversité would enable us to locally precise the composition of biomass by species and perhaps even to estimate the evolution of the total biomass during period 2. For this last purpose we recommend the use of echo-integration in the future. In the same way, it will be necessary to carry out new estimates of catches by anglers, in addition to the re-establishment of monitoring of the gear fishery (amateurs and professionals). The validation of the trophic positioning of our different groups and species may be done through stomach content and isotopic analysis. This approach will also enable us to detail ontogenic diet variations for the main large predatory fishes (European catfish, pike-perch) and use the possibilities offered by multi-stanza in Ecopath. Finally, this Ecopath model may represent a basis for the future construction of dynamic and spatial models (Ecosim and Ecospace) integrating climate change. For example, it will be possible to introduce the inter-annual variations in phytoplankton biomass estimated on the basis of changes in temperature, flow rate and nutrients into the forcing functions accepted by Ecosim.

5 **Conclusion**

This ecosystem based approach for the lower Saône has enabled us for the first time to show the feasibility, the interest and the potential offered by the assessment of the different biomasses and trophic flows between species/functional groups present in the river and the trophic flows between them.

By comparing two contrasted periods, this study showed that among invasive or expanding species, the impact of the cormorant was limited while that of the European catfish and the Asian clam were much higher. The Asian clam, by filtering phytoplankton, contributed to the regime shift of the

ecosystem. The European catfish, an opportunistic predator, substitutes for the declining fishing pressure to maintain a large flow of matter in the ecosystem.

This study should be placed in a multi-stressor context that has not been taken into account in our model (e.g. habitat degradation for and by navigation, agricultural practices and land use shifts in the flood plain, changes in temperature and flow regime in relation to climate change, changes in nutrients inputs, etc.). Moreover, since 2005, with the arrival of quagga mussel (*Dreissena rostriformis*), Louisiana crawfish (*Procambarus clarkii*) and round goby (*Neogobius melanostomus*) in the Saône watershed, the succession of invasive or expanding species occurring at all the trophic levels make our ecosystem-based approach particularly useful for managers.

References

- Angelini, R., Agostinho, A.A., 2005. Food web model of the Upper Paraná River Floodplain: description and aggregation effects. *Ecological Modelling* 181, 109–121. <https://doi.org/10.1016/j.ecolmodel.2004.06.025>
- Arrignon, J., 1991. Aménagement piscicole des eaux douces. Paris; Londres; New York: Technique et documentation - Lavoisier.
- Bachmann, V., Usseglio-Polatera, P., 1999. Contribution of the Macrobenthic Compartment to the Oxygen Budget of a Large Regulated River: The Mosel. *Hydrobiologia*, 410, 39-46.
- Baran P. et Compagnat, 2005. Etude de la transparence des eaux de trois cours d'eau de Bourgogne et de Franche Comté, Conseil Supérieur de la Pêche, Direction régionale n°9, Dijon, 13p.
- Bollache, L., Devin, S., Wattier, R., Chovet, M., Beisel, J. N., Moreteau, J. C., Rigaud, T. 2004. Rapid range extension of the Ponto-Caspian amphipod *Dikerogammarus villosus* in France: potential consequences. *Archiv fur Hydrobiologie*, 160(1), 57-66.
- Bonnamour, L. (Ed.), 2000. Archéologie de la Saône: 150 ans de recherches, Espace des arts (Gallery). ed. Editions Errance ; Ville de Chalon-sur-Saône, Paris : [Chalon-sur-Saône].
- Boudouresque C.-F., P. Astruch, D. Bănaru, Blanfuné A., B. Belloni, et al. 2020. Ecosystem-based quality indices: valuable tools for environment management. *Vie et Milieu / Life & Environment*, 2020, 70 (3-4), pp.3-15. { hal-03342401 }
- Bourgeot, F., Gontier, B., Prompt, P., 2010. Suivi écologique et Évolutif de la Lône de Jassans, Rapport pour Voies Navigables de France.
- Briand, C., Bottner, B., Lebreton, A., Pecheux, N., 2020. Invasion du bassin de la Vilaine par les corbicules et les moules zébrées (Synthèse des connaissances et bilan des travaux). EPTB Vilaine.
- Britton, J.R., Pegg, J., Sedgwick, R., Page, R., 2007. Investigating the catch returns and growth rate of wels catfish, *Silurus glanis*, using mark recapture. *Fisheries Management* 14, 263–268. <https://doi.org/10.1111/j.1365-2400.2007.00554.x>
- Brown, J.H., Lomolino, M.V., 1998. Biogeography, 2nd ed. ed. Sinauer Associates, Sunderland, Mass.
- Changeux, T., 2011. La pêche fluviale en France., n: Keith, P., Persat, H., Feunteun, E., Allardi, J. (Eds.), Les Poissons d'eau Douce de France. Patrimoines naturels, n°47, Muséum national d'histoire naturelle., pp. 196-207 + annexes (pp. 516-517).
- Changeux, T., 1996. Anglers' catches assessment during the season 1991-1992 in a French large river (the Saone). *Bulletin Francais De La Peche Et De La Pisciculture* 203–210. <https://doi.org/10.1051/kmae:1996017>
- Changeux, T., Zylberblat, M., 1993a. Analyse des statistiques de pêche aux engins dans le bassin du Rhône. Première partie : étude de l'effort de pêche. *Bulletin Français de la Pêche et de la Pisciculture* 245–269. <https://doi.org/10.1051/kmae:1993006>

- Changeux, T., Zylberblat, M., 1993b. Analyse des statistiques de pêche aux engins dans le bassin du Rhône. Deuxième partie : étude des captures. Bulletin Français de la Pêche et de la Pisciculture 271–294. <https://doi.org/10.1051/kmae:1993007>
- Chesnais, T. de la, 2013. Rôle des perchettes et impact de leur exploitation sur la structure trophique du lac d'Annecy : approche par modélisation écosystémique (Mémoire de fin d'étude d'ingénieur). Agrocampus, Rennes.
- Christensen, V., Walters, C.J., 2004. Ecopath with Ecosim: methods, capabilities and limitations. *Ecological Modelling* 172, 109–139. <https://doi.org/10.1016/j.ecolmodel.2003.09.003>
- Christensen, V., Walters, C.J., Pauly, D., 2005. Ecopath with Ecosim: A user's guide. Fisheries Centre-University of British Columbia, Canada.
- Colléter, M., Valls, A., Guitton, J., Gascuel, D., Pauly, D., Christensen, V., 2015. Global overview of the applications of the Ecopath with Ecosim modeling approach using the EcoBase models repository. *Ecological Modelling* 302, 42–53. <https://doi.org/10.1016/j.ecolmodel.2015.01.025>
- Copp, G.H., Robert Britton, J., Cucherousset, J., García-Berthou, E., Kirk, R., Peeler, E., Stakénas, S., 2009. Voracious invader or benign feline? A review of the environmental biology of European catfish *Silurus glanis* in its native and introduced ranges. *Fish and Fisheries* 10, 252–282. <https://doi.org/10.1111/j.1467-2979.2008.00321.x>
- Corrales, X., Ofir, E., Coll, M., Goren, M., Edelist, D., Heymans, J.J., Gal, G., 2017. Modeling the role and impact of alien species and fisheries on the Israeli marine continental shelf ecosystem. *Journal of Marine Systems* 170, 88–102. <https://doi.org/10.1016/j.jmarsys.2017.02.004>
- David P., Thébault E., Anneville O., Duyck P.-F., Chapuis E., Loeuille N. (2017). Impacts of Invasive Species on food webs: a review of empirical data. *Advances in Ecological Research*, 56, 1-60
- Diamond, J.S., Moatar, F., Cohen, M.J., Poirel, A., Martinet, C., Maire, A., Pinay, G., 2021. Metabolic regime shifts and ecosystem state changes are decoupled in a large river. *Limnol Oceanogr* Ino.11789. <https://doi.org/10.1002/lno.11789>
- Dickie, L.M., 1972. Food chains and fish production. *ICNAF Spec. Publ* 8, 201–221.
- Dudgeon, D., Arthington, A.H., Gessner, M.O., Kawabata, Z.-I., Knowler, D.J., Lévêque, C., Naiman, R.J., Prieur-Richard, A.-H., Soto, D., Stiassny, M.L.J., Sullivan, C.A., 2006. Freshwater biodiversity: importance, threats, status and conservation challenges. *Biol. Rev.* 81, 163. <https://doi.org/10.1017/S1464793105006950>
- EPTB Saône Doubs, (2016). Livrets des crues de la Saône, les crues de la Saône dans la basse vallée, Document cadre, 20p.
- Evariste, L., 2016. Caractérisations structurale et fonctionnelle des populations hémocytaires de la moule zébrée (*Dreissena sp.*) en vue de leur utilisation en évaluation du risque écotoxicologique (PhD thesis). Université De Reims Champagne–Ardenne.
- European Commission, 2000. Directive 2000/60/EC of the European Parliament and of the Council of 23 October 2000 establishing a framework for Community action in the field of water policy ». *Official Journal of the European Communities* 327, no 43 : 1 72.
- European Commission, 2008. Directive 2008/56/EC of the European Parliament and of the Council of 17 June 2008 establishing a framework for community action in the field of marine environmental policy (Marine Strategy Framework Directive). *Official Journal of the European Union* 164, 19–40.
- Faure, J.-P., 2013. Suivi des captures de poissons prédateurs des vallées de la Saône et du Rhône par les pêcheurs amateurs, saison 2011-2012 (Rapport technique). FDAAPPMA du Rhône, Lyon.
- Floury M., Usseglio-Polatera P., Ferréol M., Delattre C., Souchon Y., 2013. Global climate change in large European rivers: long-term effects on macroinvertebrate communities and potential local confounding factors. *Global Change Biology*, doi: 10.1111/gcb.12124

- Fonteneau, F., Paillisson, J.-M., Marion, L., 2009. Relationships between bird morphology and prey selection in two sympatric Great cormorant *Phalacrocorax carbo* subspecies during winter: Food partitioning in sympatric Great cormorant subspecies. *Ibis* 151, 286–298. <https://doi.org/10.1111/j.1474-919X.2009.00909.x>
- Fruget, J.-F., Persat, H., 2000. Changement de l'équilibre hydrobiologique de la Basse Saone. Impact de l'eutrophisation et de la contamination toxique. (COURLY mission écologique). ARALEPBP & UMR CNRS, Lyon.
- Fruget, J.-F., Persat, H., 2008. Étude et analyse du fonctionnement biologique et trophique de la Saône dans le territoire du Grand Lyon (EZUS). Lyon.
- Gallardo, B., Clavero, M., Sánchez, M.I., Vilà, M., 2016. Global ecological impacts of invasive species in aquatic ecosystems. *Glob Change Biol* 22, 151–163. <https://doi.org/10.1111/gcb.13004>
- Gamier, J., Billen, G., Coste, M., 1995. Seasonal succession of diatoms and Chlorophyceae in the drainage network of the Seine River: Observation and modeling. *Limnol. Oceanogr.* 40, 750–765. <https://doi.org/10.4319/lo.1995.40.4.0750>
- Garcia, S.M., Zerbi, A., Aliaume, C., Do Chi, T., Lasere, G., 2003. The ecosystem approach to fisheries: issues, terminology, principles, institutional foundations, implementation and outlook, FAO fisheries technical paper. Food and Agriculture Organization of the United Nations, Rome.
- Genin, B. (1992). *Corophium curvispinum* Sars, 1895 (Crustacea, Amphipoda) dans la Saône. *Bulletin scientifique de Bourgogne*, 45, 27-32.
- Godreau, V., Bornette, G., Frochot, B., Amoros, C., Castella, E., Oertli, B., Chambaud, F., Oberti, D., Craney, E., 1999. Biodiversity in the floodplain of Saone: a global approach. *Biodiversity and Conservation* 8, 839–864. <https://doi.org/10.1023/A:1008807328566>
- Hamr, P., 2002. Orconectes, in: Holdich, D.M. (Ed.), *Biology of Freshwater Crayfish*. Blackwell Science ; Distributor, USA and Canada, Iowa State University Press, Oxford [England] : Ames, Iowa, pp. 585–608.
- Hugueny, B., Oberdorff, T., Tedesco, P.A., 2010. Community Ecology of River Fishes: A Large-Scale Perspective, in: Gido, K.B., Jackson, D.A. (Eds.), *Community Ecology of Stream Fishes: Concepts, Approaches, and Techniques*. pp. 29–62.
- Janjua, M.Y., Gerdeaux, D., 2009. Preliminary trophic network analysis of subalpine Lake Annecy (France) using an Ecopath model. *Knowl. Managt. Aquatic Ecosyst.* 02. <https://doi.org/10.1051/kmae/2009008>
- Jorgensen, S.E. (Ed.), 2011. *Handbook of Ecological Models used in Ecosystem and Environmental Management*, Copenhagen University. ed. CRC Press, Denmark. <https://doi.org/10.1201/b10791>
- Keith, P., Poulet, N., 2020. L'homme facteur de changements, in: Keith, P., Poulet, N., Denys, G., Changeux, T., Feunteun, É., Persat, H. (Eds.), *Les poissons d'eau douce de France, Inventaire et biodiversité*. Biotope Editions (Mèze), Paris, pp. 77–97.
- Kramer, N.W., Phelps, Q.E., Pierce, C.L., Colvin, M.E., 2019. A food web modeling assessment of Asian Carp impacts in the Middle and Upper Mississippi River, USA. *Food Webs* 21. <https://doi.org/10.1016/j.fooweb.2019.e00120>
- Lemaire, M., Guillard, J., Anneville, O., Lobry, J., 2020. Major biomass fluctuations in lake food webs – An example in the peri-alpine Lake Annecy. *Journal of Great Lakes Research* 46, 798–812. <https://doi.org/10.1016/j.jglr.2020.04.007>
- Link, J.S., Griswold, C.A., Methratta, E.T., Gunnard, J., Brodziak, J.K.T. (Jon K.T., Col, L.A., Dow, D.D., Edwards, S.F., Fogarty, M.J., Fromm, S.A., Green, J.R., Guida, V.G. (Vincent G., 1948-, Johnson, D. (Donna L.), Kane, J.M., Legault, C.M., O'Reilly, J.E., Overholtz, W.J. (William J., Palka, D.L., 1959-, Stockhausen, W.T., Vitaliano, J.J., Waring, G.T., 2006. Documentation for

- the Energy Modeling and Analysis eXercise (EMAX). Northeast Fisheries Science Center reference document ; 06-15.
- Marguillier, S., Dehairs, F., Van der Velde, G., Kelleher, B., Rajagopal, S., 1998. Initial results on the trophic relationships based on *Corophium curvispinum* in the Rhine traced by stable isotopes. New concepts for sustainable management of river basins. Backhuys, Leiden 171–177.
- Marion, L., Bergerot, B., 2018. Northern range shift may be due to increased competition induced by protection of species rather than to climate change alone. *Ecology and Evolution* 8, 8364–8379. <https://doi.org/10.1002/ece3.4348>
- Marion, L., 2019. National census of Great Cormorant *Phalacrocorax carbo* colonies in France in 2018 and comparison with 2015. *Alauda* 89(3): 189-202.
- Mathews, C.P., 1993. Productivity and energy flows at all trophic levels in the River Thames, England: Mark 2, in: Christensen, V., Pauly, D. (Eds.), *Trophic Models of Aquatic Ecosystems*, ICLARM Conference Proceedings. pp. 161–171.
- Minaudo, C., Abonyi, A., Leitão, M., Lançon, A.M., Floury, M., Descy, J.-P., Moatar, F., 2021. Long-term impacts of nutrient control, climate change, and invasive clams on phytoplankton and cyanobacteria biomass in a large temperate river. *Science of The Total Environment* 756, 144074. <https://doi.org/10.1016/j.scitotenv.2020.144074>
- Mouthon, J., 2000. Répartition du genre *Corbicula* Megerle von Mühlfeld (Bivalvia : Corbiculidae) en France à l'aube du XXI^e siècle. *Hydroécol. Appl* 12, 135–146.
- Mouthon, J., 2001. Life cycle and population dynamics of the Asian clam *Corbicula fluminea* (Bivalvia: Corbiculidae) in the Saone River at Lyon (France). *Hydrobiologia* 452, no 1/3 (2001): 109 19. <https://doi.org/10.1023/A:1011980011889>.
- Mouthon, J., 2003. Longitudinal and temporal variations of density and size structure of *Corbicula fluminea* (Bivalvia) populations in the Saône and Rhône rivers (France). *Ann. Limnol. - Int. J. Lim.* 39, 15–25. <https://doi.org/10.1051/limn/2003001>
- Ovegård, M.K., Jepsen, N., Bergenius Nord, M., Petersson, E., 2021. Cormorant predation effects on fish populations: A global meta-analysis. *Fish Fish* 22, 605–622. <https://doi.org/10.1111/faf.12540>
- Palomares, M.L., Yulianto, B., Puy, L., Bengen, P., Belaud, A., 1993. Preliminary model of the Garonne River (Toulouse, France) ecosystem in spring, in: Christensen, V., Pauly, D. (Eds.), *Trophic Models of Aquatic Ecosystems*, ICLARM Conference Proceedings. pp. 172–179.
- Palomares, M.L.D., Pauly, D., 1998. Predicting food consumption of fish populations as functions of mortality, food type, morphometrics, temperature and salinity. *Mar. Freshwater Res.* 49, 447. <https://doi.org/10.1071/MF98015>
- Paquet, J.-Y., Otjacques, W., Libois, R., Pourignaux, F., Kestemont, P., 2022. Effects of Roach *Rutilus rutilus* Collapse on Abundance, Distribution and Diet of Great Cormorants *Phalacrocorax carbo* in a Large River in North-West Europe. *Ardea* 109. <https://doi.org/10.5253/arde.v109i1.a14>
- Persat, H., Keith, P., Denys, G., 2020. Histoire géologique et hydrographique de l'Europe moyenne, in: Keith, P., Poulet, N., Denys, G., Changeux, T., Feunteun, É., Persat, H. (Eds.), *Les poissons d'eau douce de France, Inventaire et biodiversité*. Biotope Editions (Mèze), Paris, pp. 77–97.
- Pigneur, L.M., Falisse E., Roland K., Everbecq E., Deliège J.F., Smitz J.S., Van Doninck K., Descy J.-P. 2014. Impact of Invasive Asian Clams, *Corbicula Spp.*, on a Large River Ecosystem. *Freshwater Biology* 59, no 3: 573 83. <https://doi.org/10.1111/fwb.12286>.
- Poirel A., Lauters F., Desaint B., (2008). 1977-2006, Thirty years of water temperature measurements in the Rhône Basin. *Hydroécol. Appl.* Tome 16, pp. 191–213.
- Reid, A.J., Carlson, A.K., Creed, I.F., Eliason, E.J., Gell, P.A., Johnson, P.T.J., Kidd, K.A., MacCormack, T.J., Olden, J.D., Ormerod, S.J., Smol, J.P., Taylor, W.W., Tockner, K., Vermaire, J.C., Dudgeon,

- D., Cooke, S.J., 2019. Emerging threats and persistent conservation challenges for freshwater biodiversity. *Biol Rev* 94, 849–873. <https://doi.org/10.1111/brv.12480>
- Robinson, J.V., Wellborn, G.A., 1988. Ecological resistance to the invasion of a freshwater clam, *Corbicula fluminea*: fish predation effects. *Oecologia* 77, 445–452. <https://doi.org/10.1007/BF00377258>
- Rosa, R., Carvalho A.R., Angelini R., 2014. Integrating Fishermen Knowledge and Scientific Analysis to Assess Changes in Fish Diversity and Food Web Structure. *Ocean & Coastal Management* 102: 258–68. <https://doi.org/10.1016/j.ocecoaman.2014.10.004>.
- Russell, J.C., Meyer, J.-Y., Holmes, N.D., Pagad, S., 2017. Invasive alien species on islands: impacts, distribution, interactions and management. *Envir. Conserv.* 44, 359–370. <https://doi.org/10.1017/S0376892917000297>
- Seyer, T., Bănaru D., Vaz S., Hattab T., Labrune C., Booth S., Charmasson S., 2023. Ecosystem Modelling in the Northwestern Mediterranean Sea: Structure and Functioning of a Complex System. *Journal of Marine Systems* 240: 103877. <https://doi.org/10.1016/j.jmarsys.2023.103877>.
- Ulanowick, R.E., Puccia, C.J., 1990. Mixed trophic impacts. *Coenoses* 5, 7–16. <http://www.jstor.org/stable/43461017>
- Vagnon, C., 2021. Le silure glane (*Silurus glanis*) dans les grands lacs perialpins : Ecologie trophique et impact sur les espèces résidentes. Univ. Savoie Mont blanc.
- Valls, A., Coll, M., Christensen, V., 2015. Keystone species: toward an operational concept for marine biodiversity conservation. *Ecological Monographs* 85, 29–47. <https://doi.org/10.1890/14-0306.1>
- Vojtkovská, R., Horká, I., Ďuriš, Z., 2014. The diet of the spiny-cheek crayfish *Orconectes limosus* in the Czech Republic. *Open Life Sciences* 9, 58–69. <https://doi.org/10.2478/s11535-013-0189-y>
- Wang, X.-X., Peng, L., Su, C.-J., Cheng, G.-W., 2017. Impact of Hydropower Dam Development on River Ecosystems: Ecopath Model Application on the Red River in China as an Example. *Pol. J. Environ. Stud.* 26, 2811–2821. <https://doi.org/10.15244/pjoes/73805>
- Wasson, J.G., Chandresis, A., Pella, H., Blanc, L., 2002. Définition des hydro-écorégions françaises métropolitaines. Approche régionale de la typologie des eaux courantes et éléments pour la définition des peuplements de référence d'invertébrés. IRSTEA-ex-Cemagref-MEDDE.
- Welcomme, R.L., 1985. River fisheries, FAO fisheries technical paper. Rome.
- Worischka, S., Richter, L., Hänig, A., Hellmann, C., Becker, J., Kratina, P., Winkelmann, C., 2018. Food consumption of the invasive amphipod *Dikerogammarus villosus* in field mesocosms and its effects on leaf decomposition and periphyton. *Aquatic Invasion* 13, 261–275. <https://doi.org/10.3391/ai.2018.13.2.07>
- Zajicek P., Wolter C. 2018. The gain of additional sampling methods for the fish-based assessment of large rivers. *Fisheries Research*, 197, 15-24, <https://doi.org/10.1016/j.fishres.2017.09.018>.

Ecosystem based approach to assess the impact of invasive or expanding species in the lower Saône River

Supplementary material

Table S1: Journal articles returned by the query 'invasion' and 'ecopath' (all fields) in the Web of Science database on 2023-02-17.

All aquatic ecosystems (5%)

1. Coll, M, Akoglu, E, Arreguin-Sanchez, F, Fulton, EA, Gascuel, D, Heymans, JJ, Libralato, S, Mackinson, S, Palomera, I, Piroddi, C, Shannon, LJ, Steenbeek, J, Villasante, S, Christensen, V, 2015. Modelling dynamic ecosystems: venturing beyond boundaries with the Ecopath approach. *Rev. Fish. Biol.* 25, 413-424. <http://dx.doi.org/10.1007/s11160-015-9386-x>
2. Corrales, X, Katsanevakis, S, Coll, M, Heymans, JJ, Piroddi, C, Ofir, E, Gal, G, 2020. Advances and challenges in modelling the impacts of invasive alien species on aquatic ecosystems. *Biol. Invasions* 22, 907-934. <http://dx.doi.org/10.1007/s10530-019-02160-0>

River ecosystems (2%)

3. Kramer, NW, Phelps, QE, Pierce, CL, Colvin, ME, 2019. A food web modeling assessment of Asian Carp impacts in the Middle and Upper Mississippi River, USA. *Food Webs* 21, -e00120. <http://dx.doi.org/10.1016/j.fooweb.2019.e00120>

Freshwater-Lakes, Reservoirs, Closed water bodies ecosystems (51%)

4. Apriesnig, JL, Warziniack, TW, Finnoff, DC, Zhang, HY, Lee, KD, Mason, DM, Rutherford, ES, 2022. The consequences of misrepresenting feedbacks in coupled human and environmental models. *Ecol. Econ.* 195, -107355. <http://dx.doi.org/10.1016/j.ecolecon.2022.107355>
5. Bezerra, LAV, Angelini, R, Vitule, JRS, Coll, M, Sanchez-Botero, JI, 2018. Food web changes associated with drought and invasive species in a tropical semiarid reservoir. *Hydrobiologia* 817, 475-489. <http://dx.doi.org/10.1007/s10750-017-3432-8>
6. Bezerra, LAV, Ribeiro, VM, Freitas, MO, Kaufman, L, Padial, AA, Vitule, JRS, 2019. Benthification, biotic homogenization behind the trophic downgrading in altered ecosystems. *Ecosphere* 10, -e02757. <http://dx.doi.org/10.1002/ecs2.2757>
7. Blukacz-Richards, EA, Koops, MA, 2012. An integrated approach to identifying ecosystem recovery targets: Application to the Bay of Quinte. *Aquat. Ecosyst. Health Manag.* 15, 464-472. <http://dx.doi.org/10.1080/14634988.2012.738997>
8. Colvin, ME, Pierce, CL, Stewart, TW, 2015. A food web modeling analysis of a Midwestern, USA eutrophic lake dominated by non-native Common Carp and Zebra Mussels. *Ecol. Model.* 312, 26-40. <http://dx.doi.org/10.1016/j.ecolmodel.2015.05.016>
9. Goto, D, Dunlop, ES, Young, JD, Jackson, DA, 2020. Shifting trophic control of fishery-ecosystem dynamics following biological invasions. *Ecol. Appl.* 30, -. <http://dx.doi.org/10.1002/eap.2190>
10. Kao, YC, Adlerstein, S, Rutherford, E, 2014. The relative impacts of nutrient loads and invasive species on a Great Lakes food web: An Ecopath with Ecosim analysis. *J. Gt. Lakes Res.* 40, 35-52. <http://dx.doi.org/10.1016/j.jglr.2014.01.010>
11. Kao, YC, Rogers, MW, Bunnell, DB, 2018. Evaluating Stocking Efficacy in an Ecosystem Undergoing Oligotrophication. *Ecosystems* 21, 600-618. <http://dx.doi.org/10.1007/s10021-017-0173-5>
12. Kumar, R, Varkey, D, Pitcher, T, 2016. Simulation of zebra mussels (*Dreissena polymorpha*) invasion and evaluation of impacts on Mille Lacs Lake, Minnesota: An ecosystem model. *Ecol. Model.* 331, 68-76. <http://dx.doi.org/10.1016/j.ecolmodel.2016.01.019>
13. Langseth, BJ, Rogers, M, Zhang, HY, 2012. Modeling species invasions in Ecopath with Ecosim: An evaluation using Laurentian Great Lakes models. *Ecol. Model.* 247, 251-261. <http://dx.doi.org/10.1016/j.ecolmodel.2012.08.015>
14. Natugonza, V, Ogutu-Ohwayo, R, Musunguzi, L, Kashindy, B, Jonsson, S, Valtysson, HT, 2016. Exploring the structural and functional properties of the Lake Victoria food web, and the role of fisheries, using a mass balance model. *Ecol. Model.* 342, 161-174. <http://dx.doi.org/10.1016/j.ecolmodel.2016.10.002>
15. Robinson, KF, Alsip, PJ, Drake, AR, Kao, YC, Koops, MA, Mason, DM, Rutherford, ES, Zhang, HY, 2021. Reviewing uncertainty in bioenergetics and food web models to project invasion impacts: Four major Chinese carps in the Great Lakes. *J. Gt. Lakes Res.* 47, 83-95. <http://dx.doi.org/10.1016/j.jglr.2020.11.003>
16. Rutherford, ES, Zhang, HY, Kao, YC, Mason, DM, Shakoor, A, Bouma-Gregson, K, Breck, JT, Lodge, DM, Chadderton, WL, 2021. Potential Effects of Bigheaded Carps on Four Laurentian Great Lakes Food Webs. *North Am. J. Fish Manage.* 41, 999-1019. <http://dx.doi.org/10.1002/nafm.10527>
17. Sreekanth, GB, Mujawar, S, Lal, DM, Mayekar, T, Stephen, J, Raghavan, R, Kumar, AB, Ingole, BS, 2022. Modelling the mixed impacts of multiple invasive alien fish species in a closed freshwater ecosystem in India. *Environ. Sci. Pollut. Res.* 29, 58278-58296. <http://dx.doi.org/10.1007/s11356-022-19794-8>
18. Stewart, TJ, Sprules, WG, 2011. Carbon-based balanced trophic structure and flows in the offshore Lake Ontario food web before (1987-1991) and after (2001-2005) invasion-induced ecosystem change. *Ecol. Model.* 222, 692-708. <http://dx.doi.org/10.1016/j.ecolmodel.2010.10.024>
19. Villanueva, MCS, Isumbisho, M, Kaningini, B, Moreau, J, Micha, JC, 2008. Modeling trophic interactions in Lake Kivu: What roles do exotics play?. *Ecol. Model.* 212, 422-438. <http://dx.doi.org/10.1016/j.ecolmodel.2007.10.047>
20. Wang, SC, Liu, XQ, Liu, Y, Wang, HZ, 2021. Disentangling effects of multiple stressors on matter flow in a lake food web. *Ecol. Evol.* 11, 9652-9664. <http://dx.doi.org/10.1002/ece3.7789>
21. Woodruff, P, van Poorten, BT, Walters, CJ, Christensen, V, 2021. Potential effects of invasive Dreissenid mussels on a pelagic freshwater ecosystem: using an ecosystem model to simulate mussel invasion in a sockeye lake. *Aquat. Invasions* 16, 129-146. <http://dx.doi.org/10.3391/ai.2021.16.1.09>
22. Yin, CJ, Gong, L, Chen, YS, Ni, LY, Pitcher, TJ, Kang, B, Guo, LG, 2022. Modeling ecosystem impacts of the invasive Japanese smelt *Hypomesus nipponensis* in Lake Erhai, southwestern China. *Ecol. Inform.* 67, -101488. <http://dx.doi.org/10.1016/j.ecoinf.2021.101488>
23. Zhang, HY, Rutherford, ES, Mason, DM, Breck, JT, Wittmann, ME, Cooke, RM, Lodge, DM, Rothlisberger, JD, Zhu, XH, Johnson, TB, 2016. Forecasting the Impacts of Silver and Bighead Carp on the Lake Erie Food Web. *Trans. Am. Fish. Soc.* 145, 136-162. <http://dx.doi.org/10.1080/00028487.2015.1069211>
24. Zhang, HY, Rutherford, ES, Mason, DM, Wittmann, ME, Lodge, DM, Zhu, XH, Johnson, TB, Tucker, A, 2019. Modeling potential impacts of three benthic invasive species on the Lake Erie food web. *Biol. Invasions* 21, 1697-1719. <http://dx.doi.org/10.1007/s10530-019-01929-7>

Marine ecosystem (42%)

-
25. Arias-Gonzalez, JE, Gonzalez-Gandara, C, Cabrera, JL, Christensen, V, 2011. Predicted impact of the invasive lionfish *Pterois volitans* on the food web of a Caribbean coral reef. *Environ. Res.* 111, 917-925. <http://dx.doi.org/10.1016/j.envres.2011.07.008>
 26. Bumbeer, J, da Rocha, RM, Bornatowski, H, Robert, MD, Ainsworth, C, 2018. Predicting impacts of lionfish (*Pterois volitans*) invasion in a coastal ecosystem of southern Brazil. *Biol. Invasions* 20, 1257-1274. <http://dx.doi.org/10.1007/s10530-017-1625-8>
 27. Chapman, EJ, Byron, CJ, Lasley-Rasher, R, Lipsky, C, Stevens, JR, Peters, R, 2020. Effects of climate change on coastal ecosystem food webs: Implications for aquaculture. *Mar. Environ. Res.* 162, -105103. <http://dx.doi.org/10.1016/j.marenvres.2020.105103>
 28. Corrales, X, Coll, M, Ofir, E, Heymans, JJ, Steenbeek, J, Goren, M, Edelist, D, Gal, G, 2018. Future scenarios of marine resources and ecosystem conditions in the Eastern Mediterranean under the impacts of fishing, alien species and sea warming. *Sci Rep* 8, -14284. <http://dx.doi.org/10.1038/s41598-018-32666-x>
 29. Corrales, X, Coll, M, Ofir, E, Piroddi, C, Goren, M, Edelist, D, Heymans, JJ, Steenbeek, J, Christensen, V, Gal, G, 2017. Hindcasting the dynamics of an Eastern Mediterranean marine ecosystem under the impacts of multiple stressors. *Mar. Ecol.-Prog. Ser.* 580, 17-36. <http://dx.doi.org/10.3354/meps12271>
 30. Corrales, X, Ofir, E, Coll, M, Goren, M, Edelist, D, Heymans, JJ, Gal, G, 2017. Modeling the role and impact of alien species and fisheries on the Israeli marine continental shelf ecosystem. *J. Mar. Syst.* 170, 88-102. <http://dx.doi.org/10.1016/j.jmarsys.2017.02.004>
 31. Gruss, A, Rose, KA, Simons, J, Ainsworth, CH, Babcock, EA, Chagaris, DD, De Mutsert, K, Froeschke, J, Himchak, P, Kaplan, IC, O'Farrell, H, Rejon, MJZ, 2017. Recommendations on the Use of Ecosystem Modeling for Informing Ecosystem-Based Fisheries Management and Restoration Outcomes in the Gulf of Mexico. *Mar. Coast. Fish.* 9, 281-295. <http://dx.doi.org/10.1080/19425120.2017.1330786>
 32. He, CY, Mao, SQ, Yan, XJ, Meng, KH, Hu, DF, 2021. Comparison of the 2010 and 2020 ecosystem structures in Xihu Harbor based on the Ecopath model. *Ocean Coastal Manage.* 213, -105873. <http://dx.doi.org/10.1016/j.ocecoaman.2021.105873>
 33. Katsanevakis, S, Coll, M, Frascchetti, S, Giakoumi, S, Goldsborough, D, Macic, V, Mackelworth, P, Rilov, G, Stelzenmuller, V, Albano, PG, Bates, AE, Bevilacqua, S, Gissi, E, Hermoso, V, Mazaris, AD, Pita, C, Rossi, V, Teff-Seker, Y, Yates, K, 2020. Twelve Recommendations for Advancing Marine Conservation in European and Contiguous Seas. *Front. Mar. Sci.* 7, -565968. <http://dx.doi.org/10.3389/fmars.2020.565968>
 34. Katsanevakis, S, Coll, M, Piroddi, C, Steenbeek, J, Lasram, FB, Zenetos, A, Cardoso, AC, 2014. Invading the Mediterranean Sea: biodiversity patterns shaped by human activities. *Front. Mar. Sci.* 1, -32. <http://dx.doi.org/10.3389/fmars.2014.00032>
 35. Pedersen, T, Fuhrmann, MM, Lindstrom, U, Nilssen, EM, Ivarjord, T, Ramasco, V, Jorgensen, LL, Sundet, JH, Sivertsen, K, Kallgren, E, Hjelset, AM, Michaelsen, C, Systad, G, Norrbin, F, Svenning, MA, Bjorge, A, Steen, H, Nilssen, KT, 2018. Effects of the invasive red king crab on food web structure and ecosystem properties in an Atlantic fjord. *Mar. Ecol.-Prog. Ser.* 596, 13-31. <http://dx.doi.org/10.3354/meps12548>
 36. Pinnegar, JK, Tomczak, MT, Link, JS, 2014. How to determine the likely indirect food-web consequences of a newly introduced non-native species: A worked example. *Ecol. Model.* 272, 379-387. <http://dx.doi.org/10.1016/j.ecolmodel.2013.09.027>
 37. Sadchatheeswaran, S, Branch, GM, Shannon, LJ, Coll, M, Steenbeek, J, 2021. A novel approach to explicitly model the spatiotemporal impacts of structural complexity created by alien ecosystem engineers in a marine benthic environment. *Ecol. Model.* 459, -109731. <http://dx.doi.org/10.1016/j.ecolmodel.2021.109731>
 38. Sadchatheeswaran, S, Branch, GM, Shannon, LJ, Moloney, CL, Coll, M, Robinson, TB, 2020. Modelling changes in trophic and structural impacts of alien ecosystem engineers on a rocky-shore island. *Ecol. Model.* 433, -109227. <http://dx.doi.org/10.1016/j.ecolmodel.2020.109227>
 39. Steyn, C, Shannon, LJ, Blamey, LK, 2021. Changes in food-web structure and energy flow in kelp forest ecosystems on the south-west coast of South Africa following the invasion of *lalandii*. *Food Webs* 28, -e00200. <http://dx.doi.org/10.1016/j.fooweb.2021.e00200>
 40. Vilas, D, Coll, M, Pedersen, T, Corrales, X, Filbee-Dexter, K, Wernberg, T, 2021. Future trajectories of change for an Arctic deep-sea ecosystem connected to coastal kelp forests. *Restor. Ecol.* 29, -e13327. <http://dx.doi.org/10.1111/rec.13327>
 41. Villasante, S, Arreguin-Sanchez, F, Heymans, JJ, Libralato, S, Piroddi, C, Christensen, V, Coll, M, 2016. Modelling marine ecosystems using the Ecopath with Ecosim food web approach: New insights to address complex dynamics after 30 years of developments. *Ecol. Model.* 331, 1-4. <http://dx.doi.org/10.1016/j.ecolmodel.2016.04.017>
-

Table S2: List of references used from the literature for zoobenthos biomass and production/biomass (P/B) ratio. When biomass data are in dry mass we used converting factors from Armitage (1995), Dauble (1985) and Edwards (1973). The application of criterion 4 (similar P/B ratio) and 5 (similar ecological and feeding behaviors) led to the grouping of the species into 5 functional groups.

Functional group	Species or taxa	Biomass Data	Biomass Source	P/B Source
1-Spinycheek crayfish	<i>Faxonius (Orconectes) limosus</i>	Wet mass	Roell and Orth, 1992; Ďuriš et al., 2006	Roell and Orth, 1992
2-Gammarus	<i>Dikerogammarus villosus</i>	Dry mass	Piscart, 2011	Jørgensen*, 1979
3-Other scraper collectors	<i>Tubifex tubifex</i>	Wet mass	Stevens et al., 2001	Jørgensen, 1979
3-Other scraper collectors	<i>Chironomini</i>	Dry mass	Benke et al., 1984	Benke et al., 1984
4-Asian clam	<i>Corbicula fluminea</i>	Ash free dry mass	Sousa et al., 2008; Mouthon 2003	Sousa, 2008
5-Other filter collectors	<i>Chelicorophium curvispinum</i>	Ash free dry mass	Van den Brink et al., 1993	Rajagopal et al., 1998
5-Other filter collectors	<i>Dreissena polymorpha</i>	Ash free dry mass	Nalepa et al., 1993	Dermott, 1993

* *Gammarus tigrinus* values are applied to *Dikerogammarus villosus*

- Armitage P., Cranston P.S., Pinder L.C.V., 1995. The Chironomidae. The biology and ecology of non-biting midges, Chapman & Hall. London., 572 p.
- Benke AC., Van Arsdall Jr. TC, Gillespie DM, and Parrish FK., 1984. Invertebrate Productivity in a Subtropical Blackwater River: The Importance of Habitat and Life History., Ecological Monographs, 54-1, pp. 25-63.
- Dauble DD., Daly DS., Abernathy CS., (1984). Factors affecting growth and survival of the Asiatic clam, *Corbicula* sp., under controlled laboratory conditions. In: Cardwell RD., Purdy R., Bahner RC., (eds) Aquatic Toxicology and Hazard Assessment: Seventh Symposium (ASTM STP 854). American Society for Testing and Materials, Philadelphia, PA, pp 134-144.
- Dermott, R. M., J. Mitchell, I. Murray, and E. Fear, 1993. Biomass and production of zebra mussels (*Dreissena polymorpha*) in shallow waters of northeastern Lake Erie. In T. F Nalepa and D. W. Schoesser (eds.), Zebra mussels: Biology, impacts, and control, pp. 399-414. Lewis/CRC Press, Inc, Boca Raton, FL
- Ďuriš Z., Drozd P., Horká I., Kozák P., Polícar T., 2006. Biometry and demography of the invasive crayfish *Orconectes limosus* in the Czech Republic. Bull. Fr. Pêche Piscic. 380-381, 1215-1228.
- Edwards C. A., (ed.) 1973. Environmental pollution by pesticides. - Plenum, London, 542pp.
- Jørgensen S.E., 1979. Handbook of Environmental Data and Ecological Parameters, International Society of Ecological Modelling, Copenhagen, Denmark, 1162 p.
- Mouthon J., 2003. Longitudinal and temporal variations of density and size structure of *Corbicula fluminea* (Bivalvia) populations in the Saône and Rhône rivers (France), Ann. Limnol. - Int. J. Lim. 39 (1), 15-25.
- Nalepa TF., Joann F. Cavaletto JF, Mark Ford M, Wendy M. Gordon WM, and Marijo Wimmer M, 1993. Seasonal and Annual Variation in Weight and Biochemical Content of the Zebra Mussel, *Dreissena polymorpha*, in Lake St. Clair., J. Great Lakes Res. 19(3), 541-552.
- Piscart C., Mermillod-Blondin F., Maazouzi C., Merigoux S., Marmonier P., 2011. Potential impact of invasive amphipods on leaf litter recycling in aquatic ecosystems., Biol Invasions 13:2861–2868.
- Rajagopal, S., Van der Velde G., Pfaffen BGP., and Vaate A., 1998. Growth and production of *Corophium curvispinum* G.O. Sars, 1895 (Amphipoda), an invader in the Lower Rhine. Pages 3–33 in J. C. von Vaupel Klein and F. R. Schram, editors. The biodiversity crisis and Crustacea. A. A. Balkema, Rotterdam, The Netherlands.
- Roell JMJ, Orth DJ, 1992. Production of three crayfish populations in the New River of West Virginia, USA., Hydrobiologia 228, 185-194.
- Sousa, R., C. Antunes, et L. Guilhermino 2008. Ecology of the invasive Asian clam *Corbicula fluminea* (Müller, 1774) in aquatic ecosystems: an overview. Annales de Limnologie - International Journal of Limnology 44, no 2 (2008): 85-94. <https://doi.org/10.1051/limn:2008017>.
- Stevens R., Kerans B.L., Lemmon JC., and Rasmussen C., 2001. The effects of *myxobolus cerebralis* myxospore dose on triactinomyxon production and biology of *Tubifex Tubifex* from two geographic regions. Journal of Parasitology, 87(2), 2001, p. 315-321.
- Van den Brink F.W.B., Van der Velde B., Bij de Vaate A, 1993. Explosive range extension and impact of a mass invader, *Corophium curvispinum* Sars, 1895 (Crustacea: Amphipoda), in the Lower Rhine (The Netherlands), Oecologia 93:224-232.

Table S3: Landings for two periods (in t/km²/year)

Functional group	Period 1 (1988-1993)				Period 2 (1994-2005)			
	Professional	Amateur	Angler	Total	Professional	Amateur	Angler	Total
1 Great cormorant	0	0	0	0	0	0	0	0
2 Pike-perch	0.16	0.1	0.4	0.66	0.19	0.06	0.12	0.37
3 Nothern pike	0.03	0.04	0.1	0.17	0.02	0.02	0.04	0.08
4 Other carnivorous	0.01	0.04	0.1	0.15	0.003	0.02	0.01	0.033
5 European catfish	0.03	0.06	0.005	0.095	0.23	0.12	0.18	0.53
6 Brown bullhead	0.05	0.07	0	0.12	0.004	0.004	0	0.008
7 Bleak	0.33	0.03	3	3.36	0.45	0.02	0.5	0.97
8 Juveniles	0.08	0.004	0.05	0.134	0.02	0.01	0.07	0.1
9 Other insectivorous	0.0001	5.00E-05	0	0.00015	0.0001	3.00E-05	0	0.00013
10 Barbel	0.04	0.004	0.002	0.046	0.04	0.004	0.0008	0.0448
11 Chub	0.08	0.02	0.02	0.12	0.04	0.01	0.02	0.06999999
12 Common carp	0.07	0.06	0.2	0.33	0.22	0.05	0.12	0.39
13 Tench	0.03	0.03	0.0001	0.0601	0.01	0.01	0.0001	0.0201
14 Roach	0.14	0.05	0.03	0.22	0.12	0.03	0.007	0.157
15 Breams	0.42	0.11	0.9	1.43	0.33	0.08	0.1	0.5100001
16 Other benthivorous	0.01	0.01	0.05	0.07	0.004	0.01	0.01	0.024
17 Common nase	0.01	0	0	0.01	0.001	0.001	0	0.002
18 Silver carp	0	0	0	0	0	0.0002	0	0.0002
19 Grass carp	0	0	0	0	0.001	4.00E-05	0	0.00104
20 Spinycheek crayfish	0.13	0.06	0	0.19	0.09	0.02	0	0.11
Sum	1.62	0.69	4.86	7.17	1.77	0.47	1.18	3.42

Table S4A: Diet composition (% of wet weight) of the functional groups during period 1. Prey are in the left column while predators are numbered on top.

Prey \ predator	1	2	3	4	5	6	7	8	9	10	11	12	13	14	15
1-Great cormorant	0	0	0	0	0	0	0	0	0	0	0	0	0	0	0
2-Pike-perch	0.012	0.0005	0.0004	0.01	0.01	0	0	0	0	0	0	0	0	0	0
3-Nothern pike	0.005	0.012	0.0005	0.034	0.02	0	0	0	0	0	0	0	0	0	0
4-Other carnivorous	0.005	0.006	0.005	0.01	0.005	0	0	0	0	0	0	0	0	0	0
5-European catfish	0.0005	0.0005	0.0005	0.0005	0.0005	0	0	0	0	0	0	0	0	0	0
6-Brown bullhead	0.016	0.029	0.009	0.011	0.034	0	0	0	0	0	0	0	0	0	0
7-Bleak	0.157	0.12	0.12	0.076	0.06	0.02	0	0	0	0	0	0	0	0	0
8-Juveniles	0.199	0.12	0.15	0.127	0.01	0.2	0	0	0	0	0.052	0	0	0	0
9-Other insectivorous	5 E-05	5 E-05	5 E-05	3.4 E-05	5 E-05	0	0	0	0	0	0	0	0	0	0
10-Barbel	0.007	0.01	0.007	0.007	0.008	0	0	0	0	0	0	0	0	0	0
11-Chub	0.015	0.0649	0.06	0.041	0.06	0	0	0	0	0	0	0	0	0	0
12-Common carp	0.07	0.06	0.06	0.059	0.01	0.02	0	0	0	0	0	0	0	0	0
13-Tench	0.03	0.03	0.041	0.023	0.025	0	0	0	0	0	0	0	0	0	0
14-Roach	0.193	0.203	0.193	0.113	0.217	0.02	0	0	0	0	0	0	0	0	0
15-Breams	0.22	0.26	0.25	0.16	0.34	0.02	0	0	0	0	0	0	0	0	0
16-Other benthivorous	0.04	0.01	0.034	0.01	0.01	0	0	0	0	0	0	0	0	0	0
17-Common nase	0.03	0.02	0.02	0.0158	0.02	0	0	0	0	0	0	0	0	0	0
18-Silver carp	0	0	0	0	0	0	0	0	0	0	0	0	0	0	0
19-Grass carp	0	0	0	0	0	0	0	0	0	0	0	0	0	0	0
20-Spinycheek crayfish	0	0.044	0.05	0.01	0.17	0.02	0	0	0	0	0	0	0	0	0
21-Gammarus	0	0	0	0.06	0	0	0	0	0	0.063	0.1	0	0.3	0.027	0.063
22-Others scrapers collectors	0	0.01	0	0.06	0	0.2	0.193	0.155	0.9388	0.547	0.165	0.163	0.2	0.2	0.432
23-Other filter collectors	0	0	0	0.06	0	0	0	0	0.0612	0.2108	0.066	0.024	0.24	0.507	0.2108
24-Asian clam	0	0	0	0	0	0	0	0	0	0	0	0	0	0	0
25-Zooplankton	0	0	0	0.113	0	0.4	0.795	0.695	0	0	0.004	0	0	0.003	0.05
26-Phytoplankton	0	0	0	0	0	0	0	0.1	0	0	0	0	0	0	0
27-Macrophytes	0	0	0	0	0	0	0	0	0	0	0.106	0.05	0	0	0
28-Periphyton	0	0	0	0	0	0	0	0	0	0.0043	0.277	0.211	0.013	0.213	0.0543
29-Detritus	0	0	0	0	0	0.1	0.012	0.05	0	0.175	0.23	0.552	0.247	0.05	0.19

Table S4A: continued.

Prey \ predator	16	17	18	19	20	21	22	23	24	25
1-Great cormorant	0	0	0	0	0	0	0	0	0	0
2-Pike-perch	0	0	0	0	0	0	0	0	0	0
3-Nothern pike	0	0	0	0	0	0	0	0	0	0
4-Other carnivorous	0	0	0	0	0	0	0	0	0	0
5-European catfish	0	0	0	0	0	0	0	0	0	0
6-Brown bullhead	0	0	0	0	0	0	0	0	0	0
7-Bleak	0	0	0	0	0	0	0	0	0	0
8-Juveniles	0	0	0	0	0	0	0	0	0	0
9-Other insectivorous	0	0	0	0	0	0	0	0	0	0
10-Barbel	0	0	0	0	0	0	0	0	0	0
11-Chub	0	0	0	0	0	0	0	0	0	0
12-Common carp	0	0	0	0	0	0	0	0	0	0
13-Tench	0	0	0	0	0	0	0	0	0	0
14-Roach	0	0	0	0	0	0	0	0	0	0
15-Breams	0	0	0	0	0	0	0	0	0	0
16-Other benthivorous	0	0	0	0	0	0	0	0	0	0
17-Common nase	0	0	0	0	0	0	0	0	0	0
18-Silver carp	0	0	0	0	0	0	0	0	0	0
19-Grass carp	0	0	0	0	0	0	0	0	0	0
20-Spinycheek crayfish	0	0	0	0	0	0	0	0	0	0
21-Gammarus	0.027	0	0	0	0	0	0	0	0	0
22- Others scrapers collectors	0	0	0	0	0.15	0	0	0	0	0
23-Other filter collectors	0.757	0	0	0	0.05	0	0	0	0	0
24-Asian clam	0	0	0	0	0.05	0	0	0	0	0
25-Zooplankton	0.003	0	0	0	0	0.25	0.25	0.365	0	0
26-Phytoplankton	0	0	0.847	0	0	0.05	0.25	0.365	1	0.5
27-Macrophytes	0	0.4	0	0.57	0.362	0.25	0.125	0.01	0	0
28-Periphyton	0.213	0.6	0	0.43	0.088	0.05	0.125	0.01	0	0
29-Detritus	0	0	0.153	0	0.3	0.4	0.25	0.25	0	0.5

Table S4B: Diet composition (%wet weight) of the functional groups during period 2. Preys are in the left column while predators are numbered on top.

Prey \ predator	1	2	3	4	5	6	7	8	9	10	11	12	13	14	15
1-Great cormorant	0	0	0	0	0	0	0	0	0	0	0	0	0	0	0
2-Pike-perch	0.076	0.0005	0.0004	0.015	0.026	0	0	0	0	0	0	0	0	0	0
3-Nothern pike	0.0025	0.0035	0.0005	0.004	0.01	0	0	0	0	0	0	0	0	0	0
4-Other carnivorous	0.041	0.012	0.008	0.01	0.006	0	0	0	0	0	0	0	0	0	0
5-European catfish	0.268	0.284	0.254	0.2	0.02	0	0	0	0	0	0	0	0	0	0
6-Brown bullhead	0.001	0.0022	0.002	0.0061	0.002	0	0	0	0	0	0	0	0	0	0
7-Bleak	0.19	0.13	0.11	0.07	0.05	0.02	0	0	0	0	0	0	0	0	0
8-Juveniles	0.13	0.134	0.161	0.14	0.09	0.1	0	0	0	0	0.052	0	0	0	0
9-Other insectivorous	1 E-05	5 E-05	4 E-05	3.4 E-05	5 E-05	0	0	0	0	0	0	0	0	0	0
10-Barbel	0.001	0.003	0.001	0.004	0.0045	0	0	0	0	0	0	0	0	0	0
11-Chub	0.003	0.007	0.006	0.003	0.007	0	0	0	0	0	0	0	0	0	0
12-Common carp	0.13	0.065	0.08	0.076	0.035	0.02	0	0	0	0	0	0	0	0	0
13-Tench	0.001	0.0035	0.0045	0.0043	0.005	0	0	0	0	0	0	0	0	0	0
14-Roach	0.06	0.06	0.045	0.05	0.04	0.01	0	0	0	0	0	0	0	0	0
15-Breams	0.09	0.075	0.07	0.05	0.07	0.02	0	0	0	0	0	0	0	0	0
16-Other benthivorous	0.0007	0.0007	0.0012	0.0028	0.0019	0	0	0	0	0	0	0	0	0	0
17-Common nase	0.0015	0.009	0.008	0.007	0.0065	0	0	0	0	0	0	0	0	0	0
18-Silver carp	0.004	0.0014	0.0022	0.0009	0.001	0	0	0	0	0	0	0	0	0	0
19-Grass carp	0.0005	0.0007	0.0006	0.0008	0.0009	0	0	0	0	0	0	0	0	0	0
20-Spinycheek crayfish	0	0.042	0.051	0.01	0.17	0.02	0	0	0	0	0	0	0	0	0
21-Gammarus	0	0	0	0.06	0	0	0	0	0	0.063	0.1	0	0.3	0.027	0.063
22-Others scrapers collectors	0	0.01	0	0.06	0	0.2	0.193	0.155	0.9388	0.547	0.165	0.163	0.2	0.2	0.432
23-Other filter collectors	0	0	0	0.06	0	0	0	0	0.0612	0.2108	0.036	0.014	0.24	0.507	0.101
24-Asian clam	0	0.156	0.195	0.053	0.454	0.11	0	0	0	0	0.03	0.01	0	0	0.11
25-Zooplankton	0	0	0	0.113	0	0.4	0.795	0.695	0	0	0.004	0	0	0.003	0.05
26-Phytoplankton	0	0	0	0	0	0	0	0.1	0	0	0	0	0	0	0
27-Macrophytes	0	0	0	0	0	0	0	0	0	0	0.106	0.05	0	0	0
28-Periphyton	0	0	0	0	0	0	0	0	0	0.0043	0.277	0.211	0.013	0.213	0.0543
29-Detritus	0	0	0	0	0	0.1	0.012	0.05	0	0.175	0.23	0.552	0.247	0.05	0.19

Table S4B: continued.

Prey \ predator	16	17	18	19	20	21	22	23	24	25
1-Great cormorant	0	0	0	0	0	0	0	0	0	0
2-Pike-perch	0	0	0	0	0	0	0	0	0	0
3-Nothorn pike	0	0	0	0	0	0	0	0	0	0
4-Other carnivorous	0	0	0	0	0	0	0	0	0	0
5-European catfish	0	0	0	0	0	0	0	0	0	0
6-Brown bullhead	0	0	0	0	0	0	0	0	0	0
7-Bleak	0	0	0	0	0	0	0	0	0	0
8-Juveniles	0	0	0	0	0	0	0	0	0	0
9-Other insectivorous	0	0	0	0	0	0	0	0	0	0
10-Barbel	0	0	0	0	0	0	0	0	0	0
11-Chub	0	0	0	0	0	0	0	0	0	0
12-Common carp	0	0	0	0	0	0	0	0	0	0
13-Tench	0	0	0	0	0	0	0	0	0	0
14-Roach	0	0	0	0	0	0	0	0	0	0
15-Breams	0	0	0	0	0	0	0	0	0	0
16-Other benthivorous	0	0	0	0	0	0	0	0	0	0
17-Common nase	0	0	0	0	0	0	0	0	0	0
18-Silver carp	0	0	0	0	0	0	0	0	0	0
19-Grass carp	0	0	0	0	0	0	0	0	0	0
20-Spinycheek crayfish	0	0	0	0	0	0	0	0	0	0
21-Gammarus	0.027	0	0	0	0	0	0	0	0	0
22-Others scrapers collectors	0	0	0	0	0.15	0	0	0	0	0
23-Other filter collectors	0.757	0	0	0	0.05	0	0	0	0	0
24-Asian clam	0	0	0	0	0.05	0	0	0	0	0
25-Zooplankton	0.003	0	0	0	0	0.25	0.25	0.365	0	0
26-Phytoplankton	0	0	0.847	0	0	0.05	0.25	0.365	0.8	0.5
27-Macrophytes	0	0.4	0	0.57	0.362	0.25	0.125	0.01	0	0
28-Periphyton	0.213	0.6	0	0.43	0.088	0.05	0.125	0.01	0	0
29-Detritus	0	0	0.153	0	0.3	0.4	0.25	0.25	0.2	0.5

1 Table S5: Biomasses and catch values with percentages by trophic level in lower Saône for the two
2 periods

Trophic level	Period 1				Period 2			
	Biomass (t/km ²)	%	Catch (t/km ²)	%	Biomass (t/km ²)	%	Catch (t/km ²)	%
IV	8.41	4.50%	1.355	18.91%	8.641	4.41%	0.684	20.03%
III	32.96	17.56%	4.798	66.96%	35.91	18.29%	2.078	60.76%
II	54.27	28.92%	1.013	14.14%	59.79	30.45%	0.657	19.21%
I	92	49.03%			92	46.86%		
Sum	187.64	100%	7.166	100%	196.34	100%	3.420	100%

3
4 Table S6: Summary of the PREBAL diagnostic for period 1 (A) and period 2 (B next page) with
5 reference to figures and tables available in the following for each criterion showing, in red, the
6 groups involved in the comments.

7 **A: period 1**

Criterion	Result	Diagnostic			Comments
		Good	Acceptable	Caution	
Biomasses across trophic levels					
1-Biomass should span 5–7 orders of magnitude	Figure S1A	Do not apply to non-marine ecosystems			
2-Slope (on log scale) should be 5–10% decline	Figure S1A	X			
3-Taxa notably above or below slope-line may need more attention	Figure S1A		X		see "Other insectivorous" and "Great cormorant"
Biomass ratios					
4-Compared across taxa, predators biomass should be less than that of (1 relative to) their prey	Table S7A		X		see "Carnivorous fish/Omnivorous fish" and "Carnivorous fish/Herbivorous fish"
5-Number of zeroes indicates potential trophic difference between predators and prey	Table S7A	X			
6-Compared across taxa, ratios indicate major pathways of trophic flows (e.g. benthic vs pelagic)	Table S7A	X			
Vital rates across trophic levels					
7-Normal biomass decomposition of Q/B, P/B and R/B (exception for homeotherms at upper TLs)	Figure S2A		X		
8-Taxa notably above or below trend merit further attention	Figure S2A		X		see "Common nase", "Common carp", "Chub", "Tench", "Breams" and "Barbel"
Vital rate ratios					
9-Compared across taxa, predators' Q/B, P/B and R/B should be less than 1 relative to their prey	Table S7A		X		
10-Number of zeroes indicates potential trophic difference between predators and prey	Table S7A	X			
11-P and B relative to PP approximate TL	Figure S3A	X			
12-Compared across vital rates; P/Qs or P/Rs near 1 merit reevaluating	Figure S4A		X		see "Spinycheek crayfish"
Total production and removals					
13-Total, scaled values of P, Q and R should again follow a decomposition with increasing TL	Figure S5A		X		see "Common nase", "Common carp" and "Other insectivorous"
14-Consumption of a taxa should be less than production by that taxa	Figure S5A		X		
15-Consumption by a taxa should be more than production by that taxa	Figure S5A		X		
16-Total human removals should be less than total production of a taxa	Figure S6A	X			
17-Total human removals should be compared to consumption of a taxa	Figure S6A	X			

8
9

10 Table S6: Continued
 11 **B: period 2**

Criterion	Result	Diagnostic			Comments
		Good	Acceptable	Caution	
Biomasses across trophic levels					
1-Biomass should span 5–7 orders of magnitude	Figure S1B	Do not apply to non-marine ecosystems			
2-Slope (on log scale) should be 5–10% decline	Figure S1B	X			
3-Taxa notably above or below slope-line may need more attention	Figure S1B		X		see "Other insectivorous", "Grass carp", "Silver carp"
Biomass ratios					
4-Compared across taxa, predators biomass should be less than that of (1 relative to) their prey	Table S7B		X		see "Carnivorous fish/Herbivorous fish" and "Omnivorous fish/Insectivorous fish"
5-Number of zeroes indicates potential trophic difference between predators and prey	Table S7B	X			
6-Compared across taxa, ratios indicate major pathways of trophic flows (e.g. benthic vs pelagic)	Table S7B	X			
Vital rates across trophic levels					
7-Normal biomass decomposition of Q/B, P/B and R/B (exception for homeotherms at upper TLs)	Figure S2B		X		
8-Taxa notably above or below trend merit further attention	Figure S2B		X		see "Common nase", "Grass carp", "Silver carp", "Common carp", "Tench", "Chub", "Breams" and "Barbel"
Vital rate ratios					
9-Compared across taxa, predators' Q/B, P/B and R/B should be less than 1 relative to their prey	Table S7B		X		
10-Number of zeroes indicates potential trophic difference between predators and prey	Table S7B	X			
11-P and B relative to PP approximate TL	Figure S3B	X			
12-Compared across vital rates; P/Qs or P/Rs near 1 merit reevaluating	Figure S4B		X		see "Spinycheek crayfish"
Total production and removals					
13-Total, scaled values of P, Q and R should again follow a decomposition with increasing TL	Figure S5B		X		see "Common nase", "Grass carp", "Silver carp", "Common carp" and "Other insectivorous"
14-Consumption of a taxa should be less than production by that taxa	Figure S5B		X		
15-Consumption by a taxa should be more than production by that taxa	Figure S5B		X		
16-Total human removals should be less than total production of a taxa	Figure S6B	X			
17-Total human removals should be compared to consumption of a taxa	Figure S6B	X			

12

13

14 Table S7: Biomass and vital ratios between predator and prey using Ecosystem compartments of
 15 Table1 to answer criteria 4-6 and 9 and 10 of Table S7 for period 1 (A) and period 2 (B).

16 **A: period 1**

Predator/prey	B	P/B	Q/B	R/B
Bird/Carnivorous fish	0,003	0,209	0,394	0,433
Bird/Omnivorous fish	0,011	0,256	0,741	0,920
Bird//Insectivorous fish	0,002	0,063	0,168	0,229
Bird/Benthivorous fish	0,000	0,139	0,067	0,064
Bird/Herbivorous fish	0,010	0,228	0,134	0,128
Carnivorous fish/Omnivorous fish	3,479	1,228	1,882	2,124
Carnivorous fish/Insectivorous fish	0,545	0,303	0,426	0,528
Carnivorous fish/Benthivorous fish	0,113	0,665	0,169	0,148
Carnivorous fish/Herbivorous fish	3,269	1,094	0,340	0,296
Omnivorous fish/Insectivorous fish	0,157	0,246	0,226	0,249
Omnivorous fish/Zoobenthos	0,023	0,035	0,025	0,048
Insectivorous fish/Zoobenthos	0,148	0,141	0,110	0,191
Insectivorous fish/Zooplankton	0,400	0,133	0,101	0,119
Benthivorous fish/Zoobenthos	0,710	0,064	0,277	0,681
Herbivorous fish/Benthic primary producer	0,015	0,026		
Zoobenthos/Benthic primary producer	0,625	0,679		
Zoobenthos/Zooplankton	2,707	0,946	0,920	0,624
Zoobenthos/Phytoplankton	1,504	0,371		
Zoobenthos/Detritus	4,880			
Zooplankton/Phytoplankton	0,556	0,392		

17 **B: period 2**

Predator/prey	B	P/B	Q/B	R/B
Bird/Carnivorous fish	0,009	0,209	0,394	0,014
Bird/Omnivorous fish	0,002	0,250	0,741	0,010
Bird//Insectivorous fish	0,005	0,063	0,168	0,003
Bird/Benthivorous fish	0,002	0,136	0,067	0,001
Bird/Herbivorous fish	0,041	0,228	0,134	0,013
Carnivorous fish/Omnivorous fish	0,270	1,198	1,882	0,707
Carnivorous fish/Insectivorous fish	0,543	0,301	0,426	0,241
Carnivorous fish/Benthivorous fish	0,180	0,654	0,169	0,046
Carnivorous fish/Herbivorous fish	4,466	1,094	0,340	0,913
Omnivorous fish/Insectivorous fish	2,014	0,251	0,226	0,341
Omnivorous fish/Zoobenthos	0,246	0,036	0,025	0,014
Insectivorous fish/Zoobenthos	0,122	0,142	0,110	0,041
Insectivorous fish/Zooplankton	0,400	0,134	0,101	0,016
Benthivorous fish/Zoobenthos	0,369	0,065	0,277	0,213
Herbivorous fish/Benthic primary producer	0,011	0,026		
Zoobenthos/Benthic primary producer	0,755	0,679		
Zoobenthos/Zooplankton	3,273	0,946	0,920	0,383
Zoobenthos/Phytoplankton	1,819	0,371		
Zoobenthos/Detritus	5,901			
Zooplankton/Phytoplankton	0,556	0,392		

18

19

Fig S1A: criteria 1-3

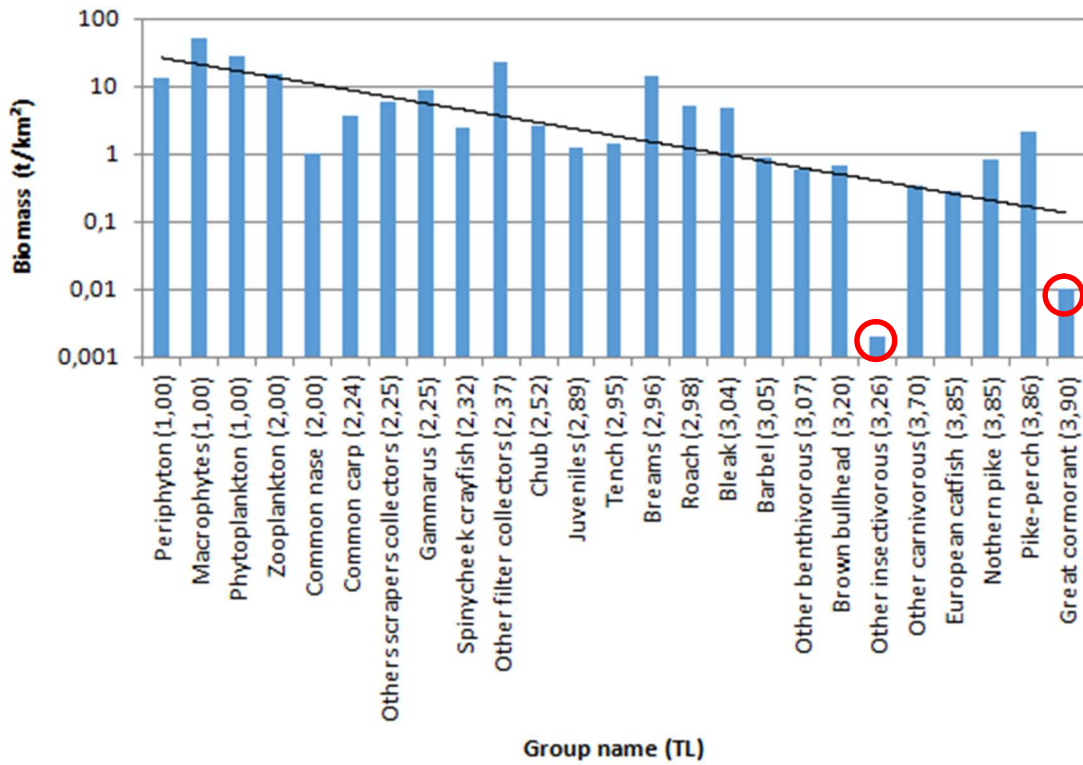

20

Fig S1B : criteria 1-3

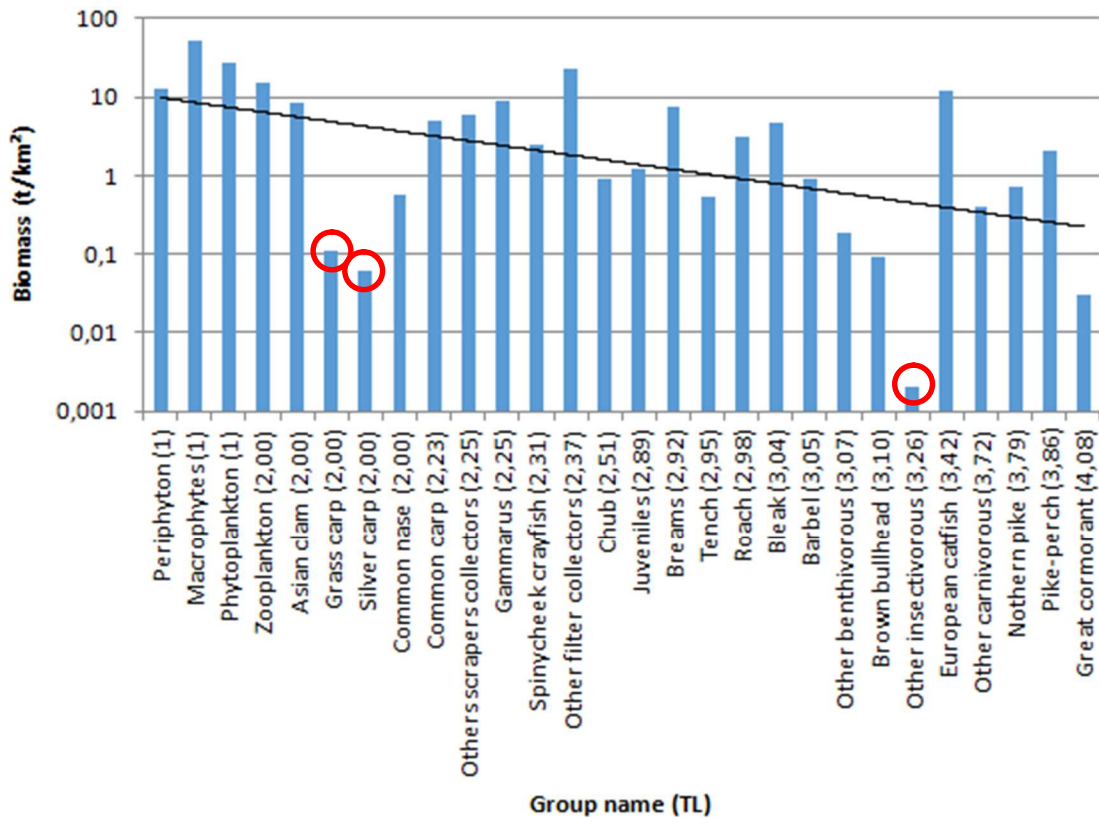

21

Fig S2A: criteria 7, 8

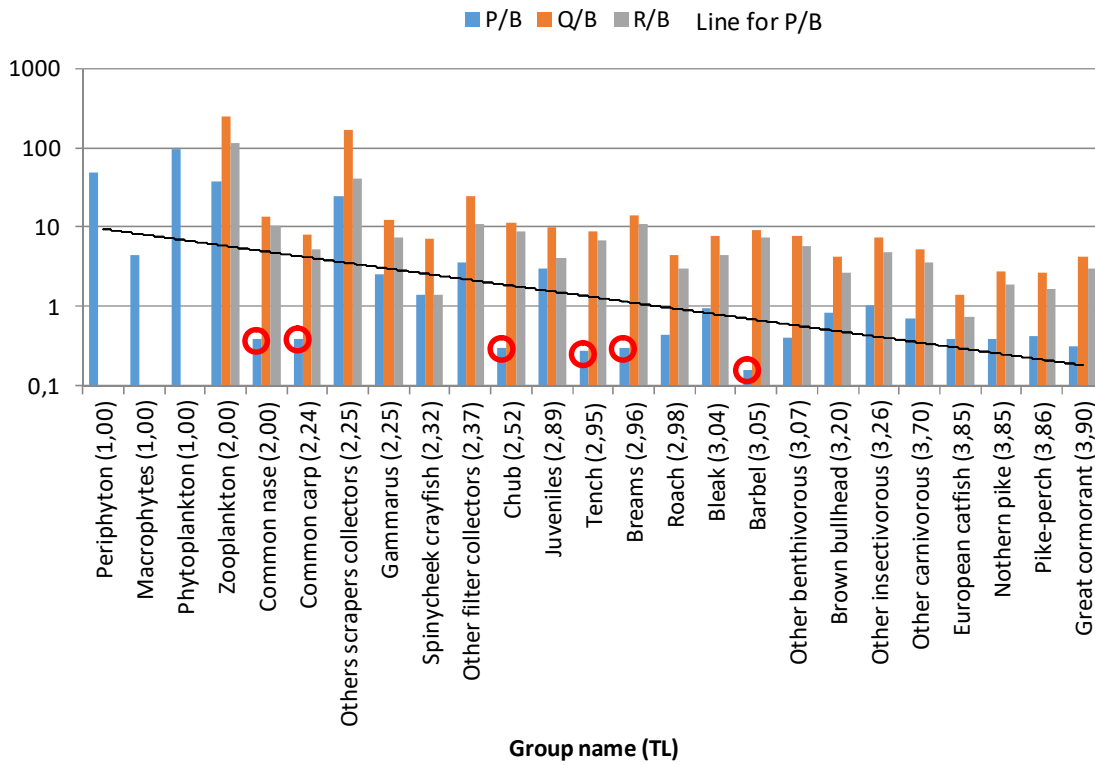

22

Fig S2B criteria 7, 8

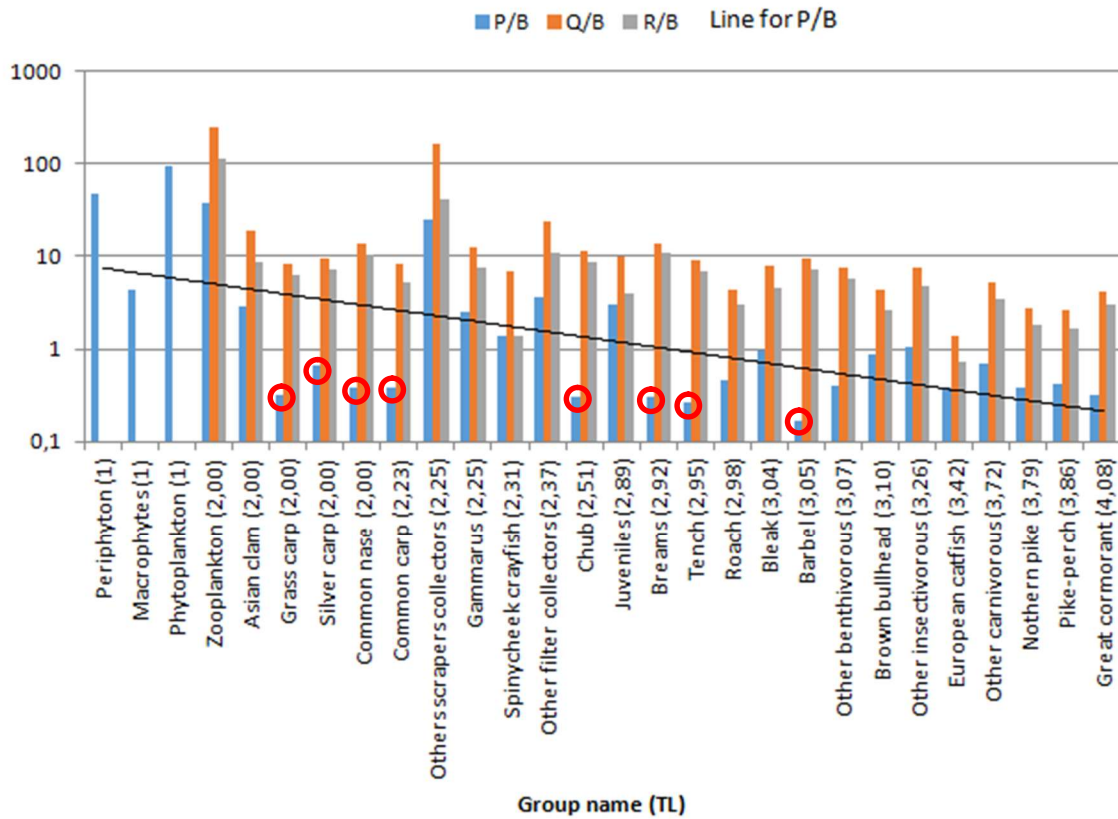

23

Fig S3A: criteria 11

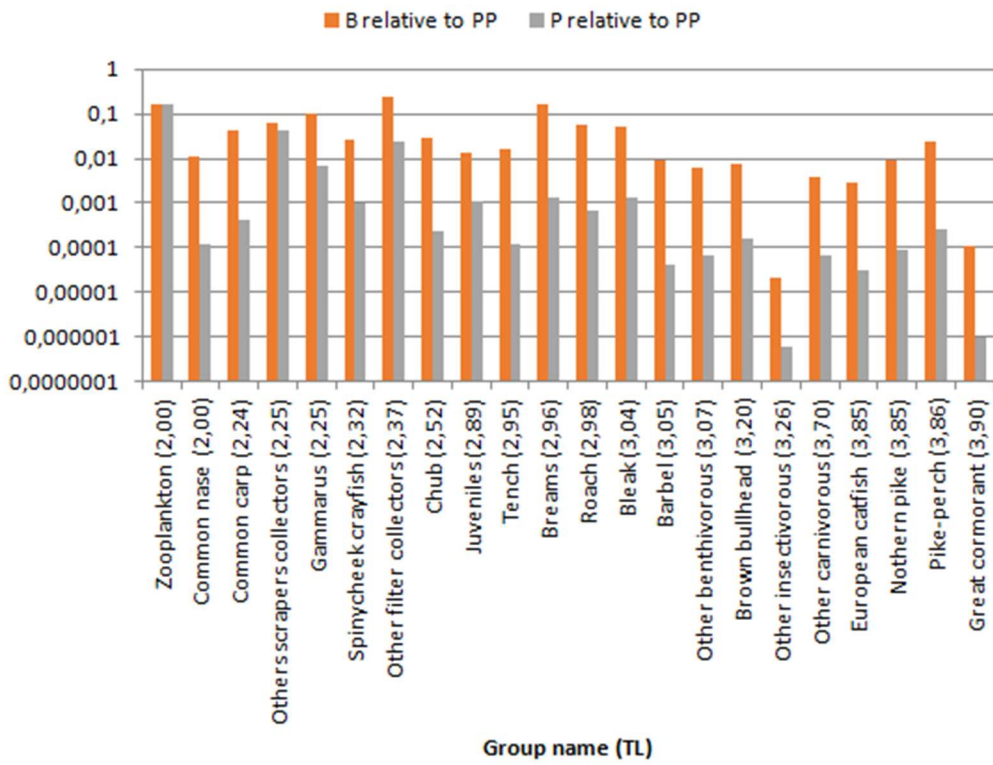

24

Fig S3B: criteria 11

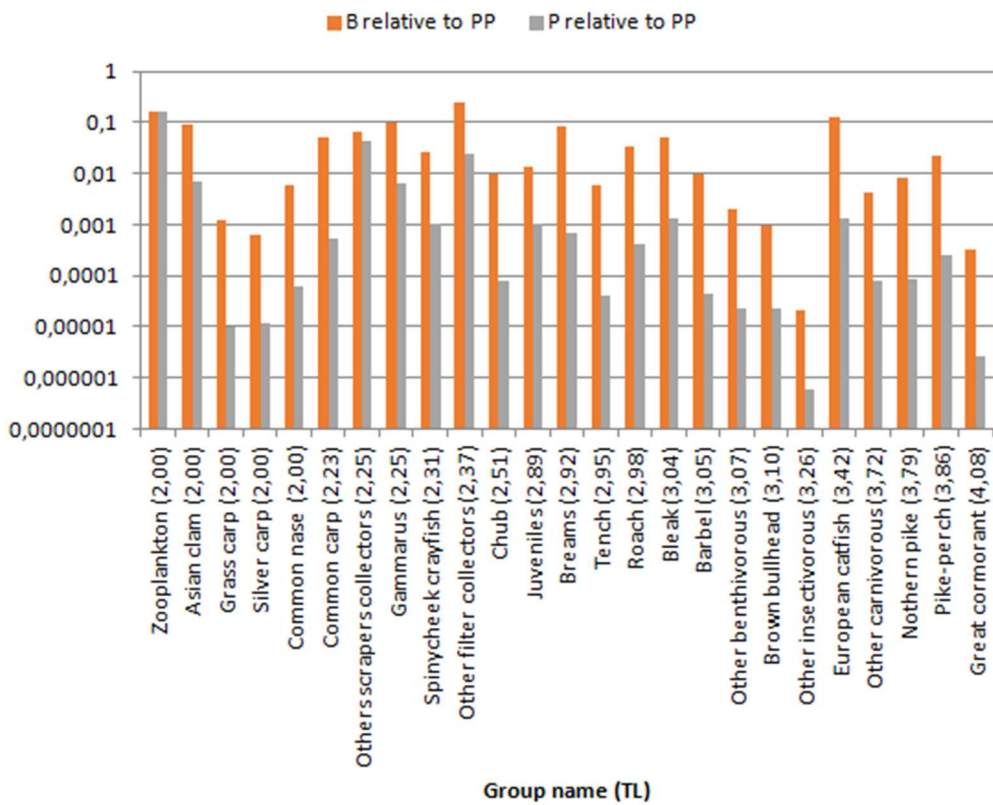

25

Fig S4A: criterion 12

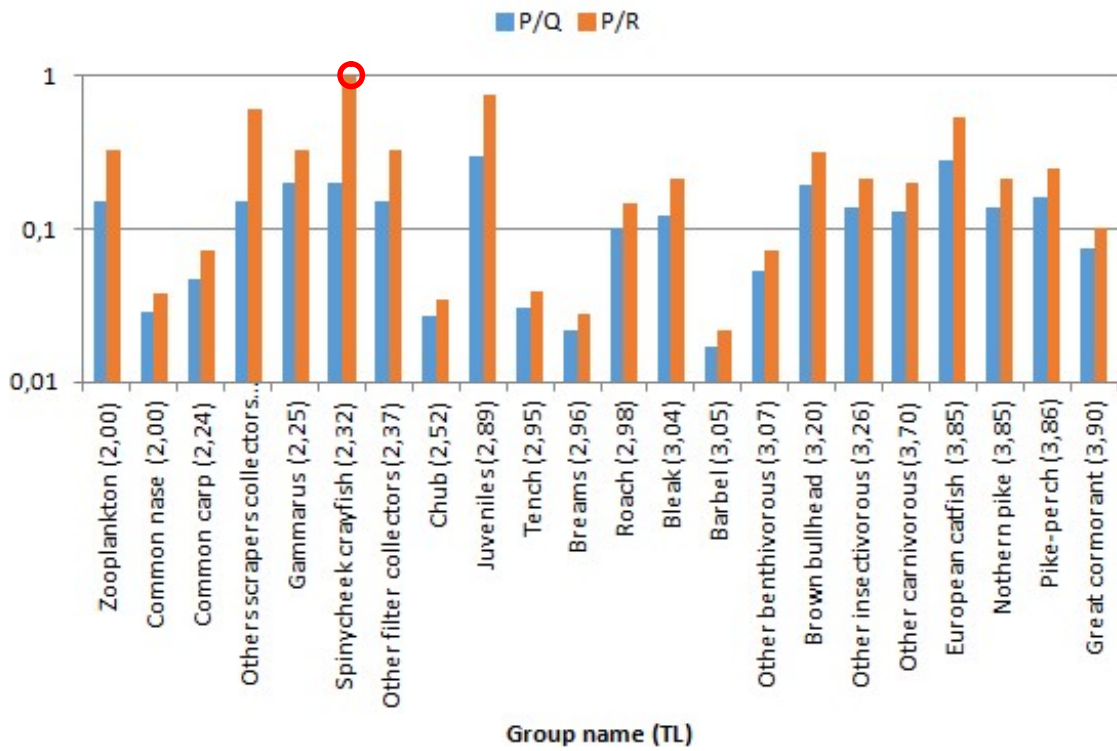

26

Fig S4B: criterion 12

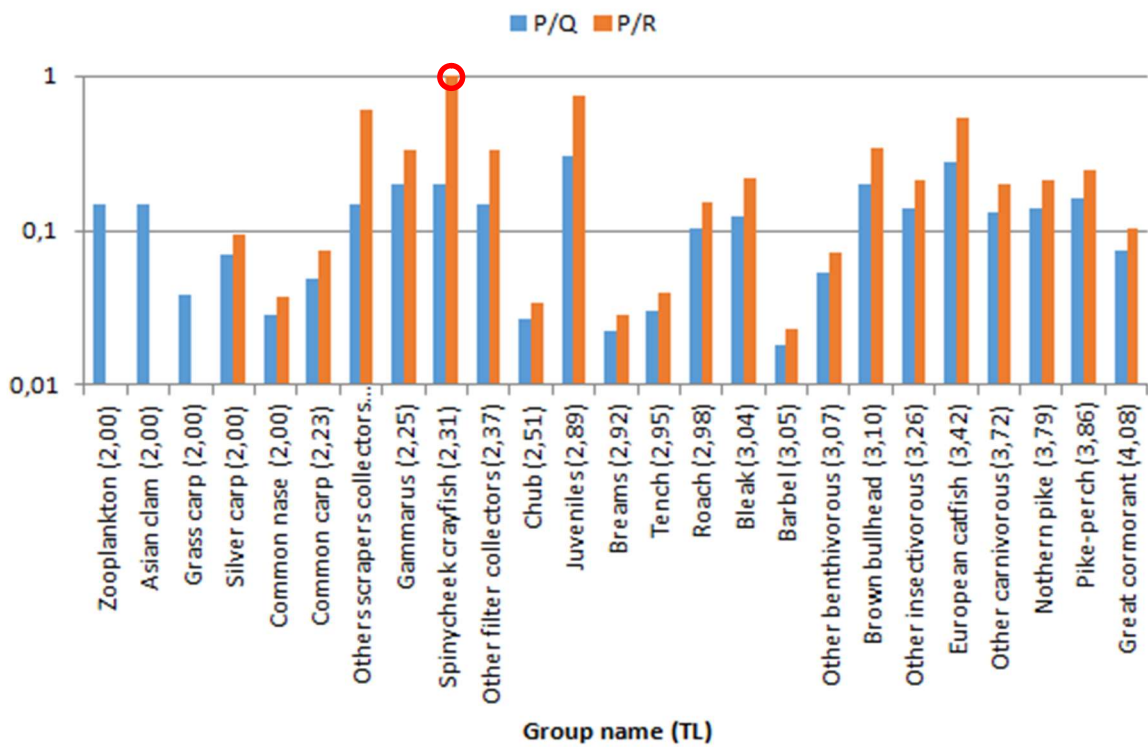

27

28

Fig S5A: criteria 13-15

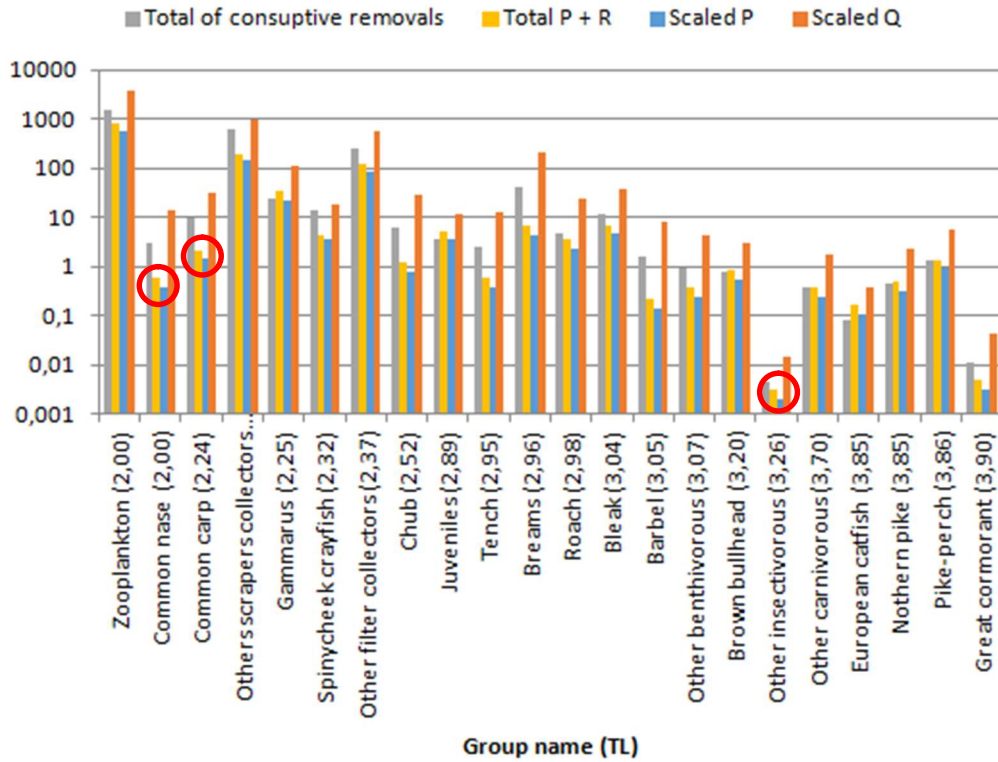

29

Fig S5B: criteria 13-15

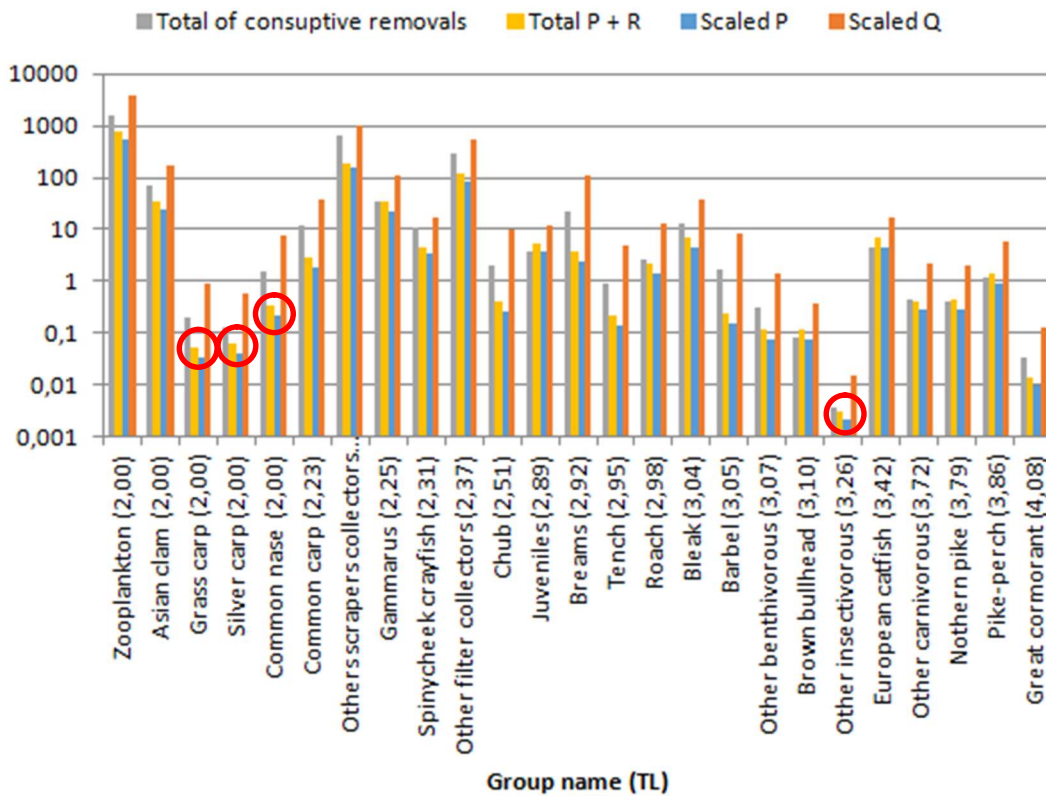

30

Fig S6A : criteria 16 and 17

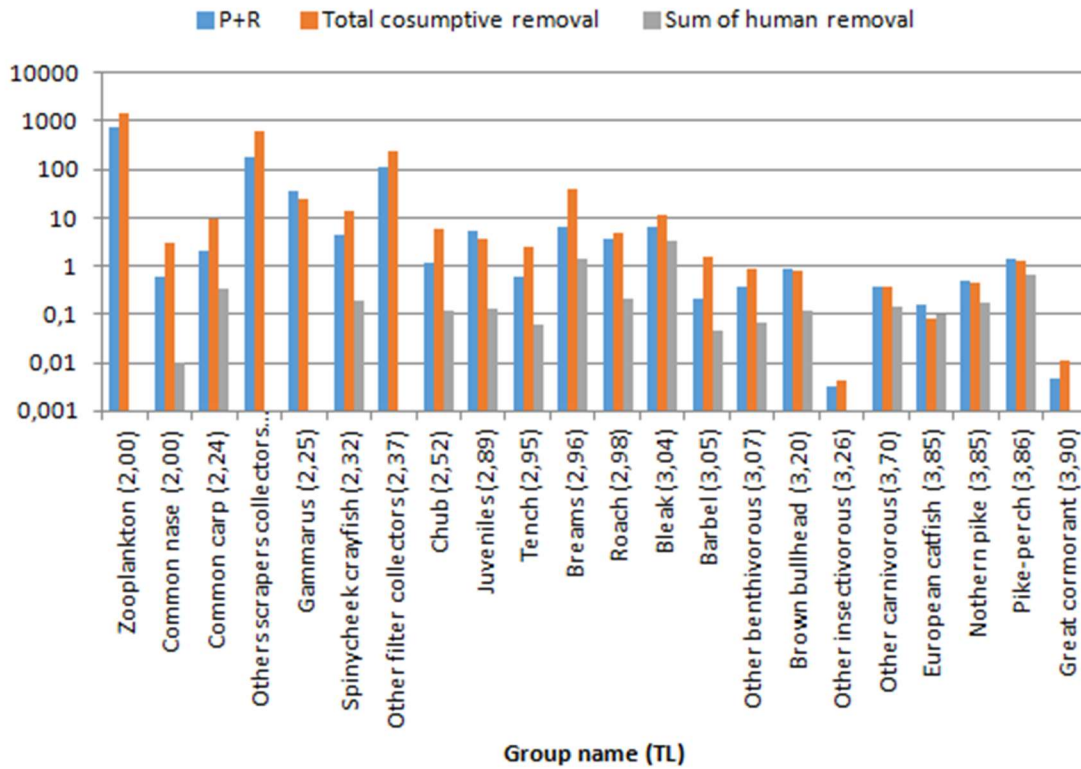

31

Fig S6B: criteria 16 and 17

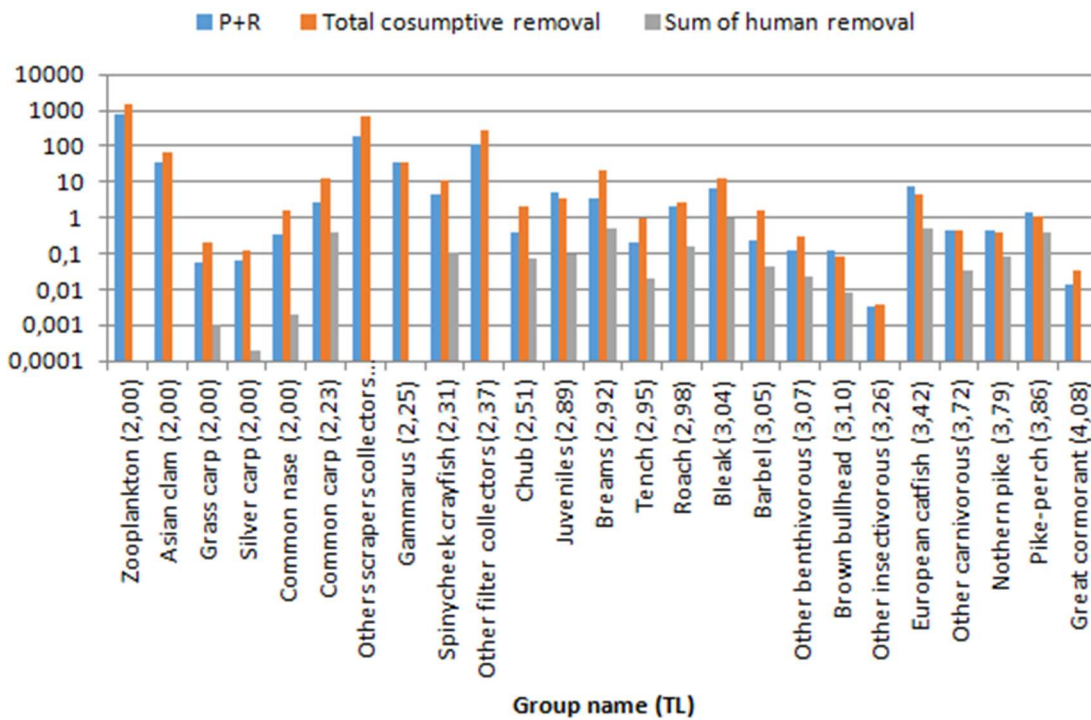

32

33