



**HAL**  
open science

# A Framework Towards Assessing the Resilience of Urban Transport Systems

Gérald Rocher, Jean-Yves Tigli, Stéphane Lavirotte, Nicolas Ferry

► **To cite this version:**

Gérald Rocher, Jean-Yves Tigli, Stéphane Lavirotte, Nicolas Ferry. A Framework Towards Assessing the Resilience of Urban Transport Systems. ARES 2024 - Proceedings of the 19th International Conference on Availability, Reliability and Security, Jul 2024, Vienna, Austria. 10.1145/3664476.3670435 . hal-04674415

**HAL Id: hal-04674415**

**<https://hal.science/hal-04674415v1>**

Submitted on 21 Aug 2024

**HAL** is a multi-disciplinary open access archive for the deposit and dissemination of scientific research documents, whether they are published or not. The documents may come from teaching and research institutions in France or abroad, or from public or private research centers.

L'archive ouverte pluridisciplinaire **HAL**, est destinée au dépôt et à la diffusion de documents scientifiques de niveau recherche, publiés ou non, émanant des établissements d'enseignement et de recherche français ou étrangers, des laboratoires publics ou privés.



Distributed under a Creative Commons Attribution - NonCommercial - NoDerivatives 4.0 International License



# A Framework Towards Assessing the Resilience of Urban Transport Systems

Gérald Rocher

gerald.rocher@univ-cotedazur.fr

Centre National de la Recherche Scientifique (CNRS, I3S)  
Université Côte d'Azur (UniCA)  
Sophia Antipolis, France

Stéphane Lavirotte

stephane.lavirotte@univ-cotedazur.fr

Centre National de la Recherche Scientifique (CNRS, I3S)  
Université Côte d'Azur (UniCA)  
Sophia Antipolis, France

Jean-Yves Tigli

jean-yves.tigli@univ-cotedazur.fr

Centre National de la Recherche Scientifique (CNRS, I3S)  
Université Côte d'Azur (UniCA)  
Sophia Antipolis, France

Nicolas Ferry

nicolas.ferry@inria.fr

I3S/INRIA Kairos  
Université Côte d'Azur (UniCA)  
Sophia Antipolis, France

## ABSTRACT

As critical cyber-physical systems, urban transport systems are vulnerable to natural disasters and deliberate attacks. Ensuring their resilience is crucial for sustainable operations and includes the ability to withstand, absorb and recover efficiently from disruptions. Assessing the resilience of such systems requires a comprehensive set of performance indicators covering social, economic, organisational, environmental and technical concerns. In addition, the interdependence of the different modes of transport and the resulting human activities requires the inclusion of the spatial dimension to capture potential cascading failures. Furthermore, the integration of both aleatory (data) and epistemic (modelling) uncertainties is essential for robust performance indicators.

Current methods for assessing the resilience of transport systems lack standardised performance indicator systems and assessment methods, making comparative analysis and benchmarking of disruption management strategies difficult. This paper proposes a unified framework for modelling and assessing performance indicators for urban transport systems. The framework is demonstrated using a simulated scenario in Eclipse SUMO and paves the way for future research in this area.

## CCS CONCEPTS

• **Computer systems organization** → **Embedded and cyber-physical systems**; • **General and reference** → **Evaluation**; • **Software and its engineering** → **Ultra-large-scale systems**; **Operational analysis**; • **Computing methodologies** → **Simulation environments**.



This work is licensed under a Creative Commons Attribution-NonCommercial-NoDerivs International 4.0 License.

ARES 2024, July 30–August 02, 2024, Vienna, Austria  
© 2024 Copyright held by the owner/author(s).  
ACM ISBN 979-8-4007-1718-5/24/07  
<https://doi.org/10.1145/3664476.3670435>

## KEYWORDS

Critical Infrastructure, Transportation System, Performance, Resilience, Simulation, RDF-star, Input/Output Hidden Markov Model

### ACM Reference Format:

Gérald Rocher, Jean-Yves Tigli, Stéphane Lavirotte, and Nicolas Ferry. 2024. A Framework Towards Assessing the Resilience of Urban Transport Systems. In *The 19th International Conference on Availability, Reliability and Security (ARES 2024)*, July 30–August 02, 2024, Vienna, Austria. ACM, New York, NY, USA, 10 pages. <https://doi.org/10.1145/3664476.3670435>

## 1 INTRODUCTION

Urban transport systems are complex, vital cyber-physical systems that are exposed to natural hazards [19] and man-made attacks [14]. To overcome these threats and ensure their continuous operation, these systems must be *resilient*. Authors in [16] define the resilience of urban transportation systems as "*the ability of a system to resist, reduce and absorb the impacts of a disturbance (shock, interruption, or disaster), maintaining an acceptable level of service (static resilience), and restoring the regular and balanced operation within a reasonable period of time and cost (dynamic resilience)*". The resilience of urban transport systems is a complex concept that requires a multidisciplinary holistic approach [9]. There is no single measure of the resilience of urban transport systems, but a set of measures based on multidimensional and multiscale performance indicators that span time and space. This can be evidenced by acknowledging the importance of urban transport systems for urban development and the resulting activities that form a *transport activity system* (Figure.1) [37]. As shown in Figure.1, for a meaningful assessment of the resilience of urban transport systems, performance indicators:

- (i) must capture all concerns of human society ranging from *economic concerns* (e.g. profits of a freight transport company, inherent costs), *social concerns* (user satisfaction, convenience, speed and quality of transport), *organisational concerns* (e.g. capacity to react timely to disruptions) to *environmental concerns* (e.g. pollutant levels, noise, etc.), in addition to the *technical concerns*, to name but a few [41].
- (ii) have to be considered both temporally and spatially [26]. Indeed, the diversity of urban transport modalities and their enabling human activities create a spatial *interdependence* in

the use of the underlying infrastructure and services. This interdependence exposes urban transport systems and human activities to the risk of *cascading failures*.

- (iii) must take into account the degree of ignorance or incomplete knowledge about the system and the concerns (*epistemic uncertainty*) and the inherent randomness and natural variability associated with the properties that characterise the concerns and their observation means, through physical or logical sensors (*aleatory uncertainty*) [41].

Evaluating the performance of urban transport systems presents substantial challenges due to the heterogeneity, scale and uncertainty of data sources. Fortunately, Internet of Things (IoT) technologies, which play a central role in smart city initiatives worldwide, offer valuable support in this regard. These technologies enable remote monitoring, management and control of devices and generate new insights and actionable information from large real-time data streams. Yet, existing approaches to resilience assessment suffer from several limitations. They do not assess resilience on the basis of a standardised and well-defined indicator system, but use different indicators, criteria and assessment methods [50]. In addition, resilience assessment approaches mainly rely on a single (or aggregated) operational measure of performance, functionality or quality [42], which is often limited to the technical dimension of the resilience [28]. In addition, interdependencies between concerns are rarely considered, e.g. the impact of technical degradation on economic, environmental, organisational or social resilience [22]. An important aspect that is missing in existing resilience assessments is the measurement of uncertainty, although methods for assessing uncertainty are crucial for the further development of resilience theory and the application of resilience approaches [2]. To address these challenges, this paper outlines a unified framework to modelling and evaluating the performance of urban transport systems. The proposed framework is divided into three distinct parts detailed in the following sections:

- (1) The Section.2 introduces the **RDF-star semantic knowledge base and its reasoning engine** [18], which provides a structured and machine-understandable representation of the transport activity system captured from sensor data that are continuously made available within smart-cities, equipped with semantic annotations that describe, among other things, their origin and the degree of certainty regarding the validity of their value;
- (2) The Section.3 describes a **unified modelling approach for the specification of performance indicators from which performance assessment monitors are derived**. The proposed modelling approach makes it possible to capture concerns at different levels of abstraction while incorporating epistemic and aleatory uncertainties;
- (3) The Section.4 details the **simulation environment** based on Eclipse SUMO (Simulation of Urban MObility) [24] that plays the role of the transport activity system.

Finally in Section.4, the proposed framework is applied to a scenario derived from the MoST scenario [12].

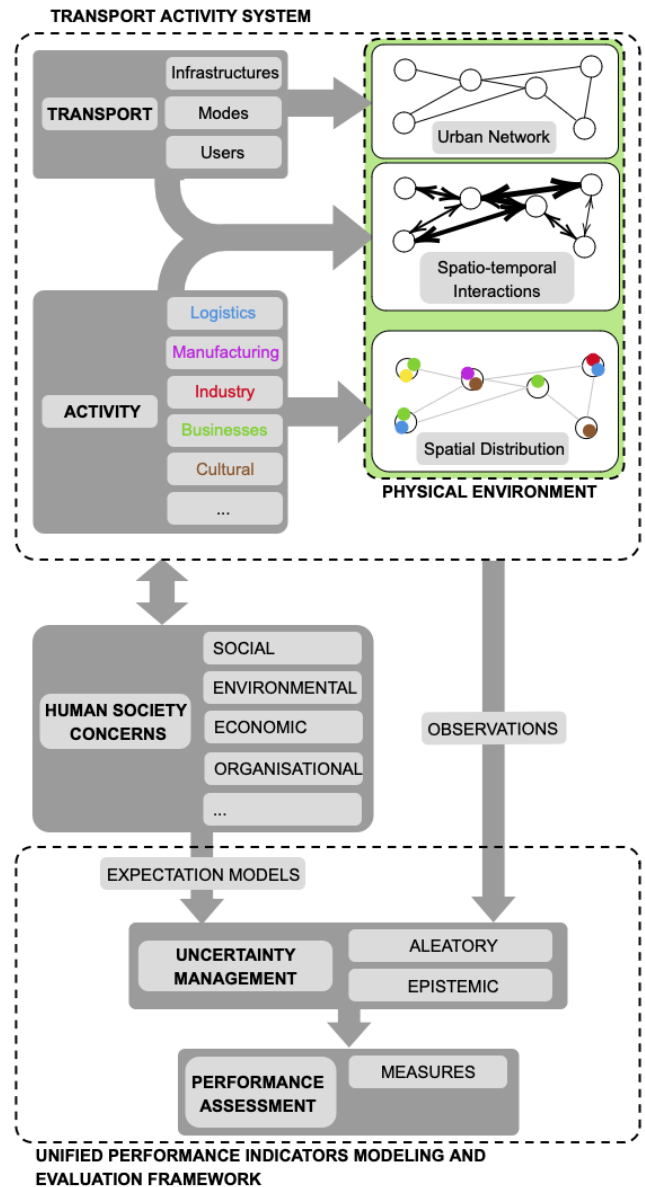

Figure 1: Performance Assessment of Urban Transport Systems

## 2 UNCERTAIN KNOWLEDGE MANAGEMENT

With the development of the IoT and smart-cities in particular [51], more and more sensors are being installed at the edge of the infrastructure, enabling continuous monitoring and analysis of our environment [31]. This proliferation has benefited greatly from the semantic web technologies and has given rise to the Semantic Web of Things (SWoT) [20]. These technologies have demonstrated their advantages in structuring and linking data on the web as well as establishing the *interoperability* of sensors and their data thanks to semantic annotations [4]. These annotations are based on formal description languages (e.g. Resource Description Framework (RDF),

RDF Schema (RDFS) and Web Ontology Language (OWL)) that offer advanced conceptual modelling capabilities. They are all based on RDF triples (*subject, predicate, object*), where the *predicate* defines a directed binary relation between a *subject* and an *object* [17]. In addition, semantic web technologies provide *reasoning capabilities* that enable IoT-based applications to make relevant decisions by drawing inferences from all available semantic descriptions stored in a Knowledge Base (KB) [25].

Formal description languages thus make it possible to describe and reason about a broad spectrum of multidisciplinary knowledge (also known as ontologies)[45]. This is particularly interesting in the context of the resilience assessment of urban transport systems, which, as mentioned previously, relies on performance indicators based on a wide range of heterogeneous data about human society (i.e. economic, social, environmental, etc.). However, semantic web technologies do not cope well with *uncertainty*, neither in the formal description of knowledge nor in the computation of inferences [29], i.e. an RDF triple is considered a *fact* or a *statement* which is by definition, something unambiguously true. However, uncertainties exist at all levels of the IoT infrastructure [6].

Firstly, one must take into account the uncertainties related to the availability and reliability of sensors, which depend on technological constraints, environmental hazards and harsh conditions such as heat, frost, vibration, humidity, etc. [34]. For example, the performance of a solar panel degrades over time and is very sensitive to the environment (clouds, dust, etc.). The reliability of the observations generated by a sensor can be affected by a low battery, by internal faults leading to erroneous readings [21], by the relevance of the sensor location in relation to the phenomenon observed, etc. at the network infrastructure level, wireless communication is also subject to technological limitations and environmental risks that can lead to latency or interruptions in the availability of information over different time periods [38]; finally, at the application level, although SWoT provides means to solve the interoperability issue, it suffers from the problem of semantic heterogeneity, as there is currently no universally accepted standard for the description of sensors and their data. Although there are some efforts to define a standard [27], the industrial actors involved in IoT often develop their own ontological models. As a solution to this problem, ontology alignment engines aim to make different ontologies interoperable [32]. However, the results are subject to uncertainties, which are often arbitrated on the basis of a threshold value [44].

At this point, a distinction is made between uncertainty arising from aleatory uncertainty, inherent randomness and natural variability and epistemic uncertainty related to a certain degree of ignorance or incomplete knowledge about the system under consideration. While aleatory uncertainty cannot be reduced by additional knowledge, epistemic uncertainty can be reduced by a better understanding [13]. The evaluation of aleatory and epistemic uncertainties has several semantics in IoT. It includes the *reliability* and *Quality of Information* (QoI) of IoT devices, sensor data and communication networks, the quantification of which is crucial [21]. In recent years, numerous metrics have been proposed [1][11][7]. Furthermore, at the edge of the IoT infrastructure, NN-based classifiers are used to process raw sensor data, resulting in *symbolic information* weighted with a *confidence level* [15]. For example, Long Short Term Memory (LSTM) algorithms, among others, automatically classify sensor

observations into higher-level classes of human activity weighted by a probability over all the classes predicted by the model [10]. As already mentioned, semantic heterogeneity leads to ontological alignments that result in correspondences between semantically related entities characterised by a certain degree of *relatedness* or *similarity*.

In IoT, uncertainty is a ubiquitous concept, but all related attributes have in common that they question the *trustworthiness* of the information they qualify. In this paper, the semantics of uncertainty is therefore defined as "*the degree of certainty*  $\in [0, 1]$  that one can have in an RDF statement to accurately reflect the corresponding situation in the real world". [3]. Recently, RDF-star [18] has made it possible to add descriptions to RDF statements, including scores, weights, temporal aspects, and provenance (RDF-star is currently only a draft and not part of the W3C RDF recommendation). In a formal sense, RDF-star extends RDF-based languages by allowing statements about statements (also known as *reification* in the context of RDF). In this paper, facts are associated with certainty values that they are true. The following is a simple example in which a fact (here the value of a sensor) is linked to a certainty value.

```
@prefix ex: <http://example.org/> .
@prefix sosa: <http://www.w3.org/ns/sosa/> .
<<ex:sensor_1 sosa:hasSimpleResult 22.4>> ex:probability 0.9 .
```

Together with RDF-star, SPARQL-star enables the retrieval of information from the knowledge base. Derived from the SPARQL query language, SPARQL-star inherits its expressive power [5]. For example, the following query:

```
PREFIX sosa: <http://www.w3.org/ns/sosa/>
PREFIX ex: <http://example.org/>
SELECT ?o ?r ?c WHERE {
  <<?o sosa:hasSimpleResult ?r>> ex:certainty ?c .
}
```

returns the following result:

?o	?r	?c
ex:sensor_1	22.4	0.90

What makes semantic web technologies and the first-order logic on which they are based so powerful is the ability to infer from the facts, i.e. to derive new facts. However, reasoning with RDF-star in general and with uncertainty in particular is not straightforward [48]; the management of the inference rules remains the responsibility of the developer, as the inference computations depend on the semantics of the statements about the statements.

RDF-star is still in its infancy and only a few open source implementations are available. In the context of the framework described in this paper, the DotNetRDF library was used [47]. Based on this library, a set of inference rules for RDF-star statements was developed to deal with uncertainties. It consists of a set of inference rules that propagate the uncertainty to the inferred facts. Most RDF, RDFS and OWL inference rules [43] can be rewritten to handle and propagate uncertainties as defined in this paper. For example, the OWL Web Ontology Language Reference [8] defines the transitivity inference rule as follows: if a property P is a transitive property,

then if a pair  $(x,y)$  is an instance of  $P$ , and the pair  $(y,z)$  is also instance of  $P$ , then it can be inferred that the pair  $(x,z)$  is also an instance of  $P$ .

More formally:

$$\langle x, P, y \rangle, \langle y, P, z \rangle \implies \langle x, P, z \rangle \quad (1)$$

The same rule is expressed in RDF star with uncertainty as follows (where  $c_1$  and  $c_2$  are the level of certainty  $\in [0, 1]$  that the associated statement is true):

$$\langle x, P, y \rangle^{c_1}, \langle y, P, z \rangle^{c_2} \implies \langle x, P, z \rangle^{c_1 \times c_2} \quad (2)$$

The technologies of the Semantic Web are based on the idea of the open world. In an open world, if a certain statement is not present in the ontology, this does not mean that the statement is false, but rather that it is unknown. In other words, the system does not automatically conclude that something is false because it is not explicitly defined i.e. having the statement `ex:car_1 ex:isThermicCar true` does not mean that `ex:car_1 ex:isThermicCar false` is not true, but it is considered unknown. The introduction of the certainty that a statement is true, denoted as  $c_1$ , allows the conclusion that the certainty that it is false is  $c_2 = 1 - c_1$ . More formally, the following inference rules was defined:

$$\begin{aligned} \langle x, P, \text{true} \rangle^{c_1} &\implies \langle x, P, \text{false} \rangle^{1-c_1}, \\ \langle x, P, \text{false} \rangle^{c_1} &\implies \langle x, P, \text{true} \rangle^{1-c_1} \end{aligned} \quad (3)$$

In addition to the definition of inference rules, the SPARQL-star query language has to enable the aggregation of results (this can be achieved by defining SPARQL extensions). This is crucial as in some situations multiple facts within the knowledge base can fulfil a single query. This can be the case when different sensors provide statements about one and the same phenomenon. The previous query could return the following results, for example:

?o	?r	?c
ex:sensor_1	22.4	0.90
ex:sensor_2	21.2	0.95
ex:sensor_5	20.1	0.92

In this paper, assuming that the unit of measurement is the same for all sensors, the aggregation of the results is achieved by using a weighted average where the weights are the levels of certainty associated with each statement matching the query `«?o sosa:hasSimpleResult ?r»`. The aggregated value is then calculated as follows:

$$R = \frac{\sum_{i=1}^n (r_i \times c_i)}{\sum_{i=1}^n (c_i)} \quad (4)$$

The level of certainty that the aggregated value is true is calculated as follows:

$$C = \prod_{i=1}^n (c_i) / \sum_{i=1}^n (c_i) \quad (5)$$

This section has provided an overview of data management with uncertainty using RDF-star/SPARQL-star frameworks. A complete and detailed explanation of the implementation of RDF-star/SPARQL-star with uncertainty management is beyond the scope of this

document. In the next section, the performance assessment engine is presented and the coupling with the RDF-star knowledge base is explained.

### 3 PERFORMANCE MODELLING AND EVALUATION FRAMEWORK

The resilience of urban transport systems requires various performance indicators which, beyond technical concerns, must also encompass all facets of human society, including economic, social, organisational and environmental concerns. However, while performance-based indicators such as level of service, capacity and travel time are commonly used to assess the resilience of urban transport systems [39], not enough attention is paid to socio-economic, organisational and environmental indicators [49]. The intricate interplay between the various modes of urban transport and the human activities they enable leads to a spatial dependency in the use of shared infrastructures and services. This inherent interdependence makes both the transport system and the associated human activities vulnerable to cascading failures. Consequently, when assessing the resilience of urban transport systems, it is crucial to include both the temporal and spatial perspective in the performance indicators [39]. However, most publications in the literature do not consider all modes of transport offered and their interrelationships, as they do not take into account the influence of the disruption of one mode on the others. In addition, none of the publications allow the comparison of performance indicators between different regions [26]. Finally, current approaches to assessing resilience suffer from a lack of standardisation of indicator systems, which leads to inconsistencies and limited comparability. In order to make meaningful comparisons, a standardised system of criteria and benchmarks is required for carrying out resilience assessments.[50].

In the sequel, a general approach to modelling and evaluating performance indicators is proposed. It builds on the mathematical framework described in [36]. Essentially, the approach consists in computing the *likelihood* of an observation sequence to conform a behavioural model. In the context of this study, the behavioural model formalises the properties that must be fulfilled for certain concerns (e.g. economic, social, etc.) and is described in the form of a Possibilistic Input/Output Hidden Semi-Markov Model (P-IOHSM). Formally, a P-IOHSM is defined by the tuple  $\langle Q, \vec{\pi}, A, B, \vec{S}_d, T_d \rangle$  where:

- $Q = \{x_1, x_2, \dots, x_N\}$  is the finite set of hidden states;  $x_{(k)}$  denotes a hidden state at time  $k$ ,
- $\vec{\pi} = (\pi_1, \pi_2, \dots, \pi_N)^T$  is the initial state distribution vector.  $\pi_i$  denotes the degree of possibility of the state  $i$  to be the first state of a state sequence,
- $A$  is the  $N \times N$  *state-transition* matrix, where each cell  $A_{ij}$  of the matrix is an *input*  $d_{ij}$ -dimensional distribution of possibility ( $1 \leq i, j \leq N$ ).  $A_{ij}(\vec{u}) = p(x_{(k+1)} = j | x_{(k)} = i, \vec{u}_{(k)} = \vec{u})$  denotes the degree of possibility of transitioning to state  $x_{(k+1)} = j$  at time  $k + 1$ , given the current state  $x_{(k)} = i$  and the input vector  $\vec{u}_{(k)} = \vec{u}$  at time  $k$ . The sample space of  $\vec{u}_{(k)}$  is continuous (i.e. realizations of  $\vec{u}_{(k)} \in \mathbb{R}^{d_{ij}}$ ),

- $\vec{B} = (B_1, B_2, \dots, B_N)^T$  is the *state-emission* vector, where each element  $B_i$  ( $1 \leq i \leq N$ ) is an *output*  $b_i$ -dimensional distribution of possibility.  $B_i(\vec{y}) = p(\vec{y}_{(k)} = \vec{y} | x_{(k)} = i)$  denotes the degree of possibility of observing the output vector  $\vec{y}_{(k)} = \vec{y}$  at time  $k$  while being in the state  $x_{(k)} = i$ . The sample space of  $\vec{y}_{(k)}$  is continuous (i.e. realizations of  $\vec{y}_{(k)} \in \mathbb{R}^{b_i}$ ),
- $\vec{S}_d = (S_{d_1}, S_{d_2}, \dots, S_{d_N})^T$  is the state duration vector where each element  $S_{d_i}$  ( $1 \leq i \leq N$ ) is a one-dimensional distribution of possibility.  $S_{d_i}(z)$  ( $z \in \mathbb{N}$ ) is the degree of possibility of being in the state  $x_{(k)} = i$  during  $z$  consecutive observations<sup>1</sup>,
- $T_d$  is the  $N \times N$  state-transition duration matrix where each cell  $T_{d_{ij}}$  ( $1 \leq i, j \leq N$ ) is a one-dimensional distribution of possibility.  $T_{d_{ij}}(z)$  ( $z \in \mathbb{N}$ ) is the degree of possibility for the state-transition  $A_{ij}$  to last during  $z$  consecutive observations. In other words, it is the elapsed time required for the output of the next state  $x_{(k+1)} = j$  to get stabilized (settling time) with  $T_{d_{ij}} < S_{d_j}$ .

Given the parameters  $\Theta = \langle \vec{\pi}, A, \vec{B}, \vec{S}_d, T_d \rangle$  of the model and an input sequence  $\vec{u}_{1:K}$  of length  $K$ , the *evaluation problem* consists in *measuring* the degree of possibility that the output sequence  $\vec{y}_{1:K}$  was generated by the model. The solution to this problem is given by the possibilistic version of the *forward* algorithm [36].

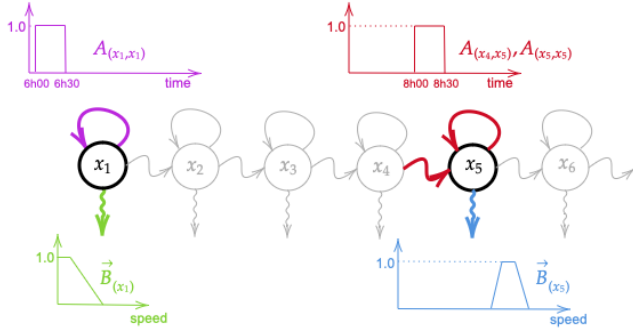

Figure 2: P-IOHMM example

Distributions of possibility enable the definition of *tolerances* around expectations, thereby allowing for the handling of epistemic uncertainty. Figure. 2 provides a simple illustrative example. Here, a P-IOHMM models the expected average vehicle speed within a particular zone of the transport network (e.g. a lane, a district, etc.). This model relies on statistical data and adapts according to the time of day. In this instance,  $\vec{u}_{1:K}$  relates to time, while  $\vec{y}_{1:K}$  corresponds to live observations of vehicle speeds within the particular zone of the transport network. This approach offers enough flexibility to be applied to any property, provided that distinct states can be extracted from the data [35]. The approach is multivariate, which means that in addition to speed, other properties can be used to define a state.

<sup>1</sup>The elapsed time is given as the number of observations and consequently depends on their sampling rate.

In this paper, corresponding to Section.2, live observation values denoted by  $\vec{u}_{1:K}$  and  $\vec{y}_{1:K}$  are obtained using SPARQL-star queries. For instance, Figure.3 illustrates SPARQL-star queries employed to retrieve  $\vec{y}$  as the weighted average speed of all vehicles belonging to a specific class within a designated area of the transportation network, and  $\vec{u}$  as the time value.

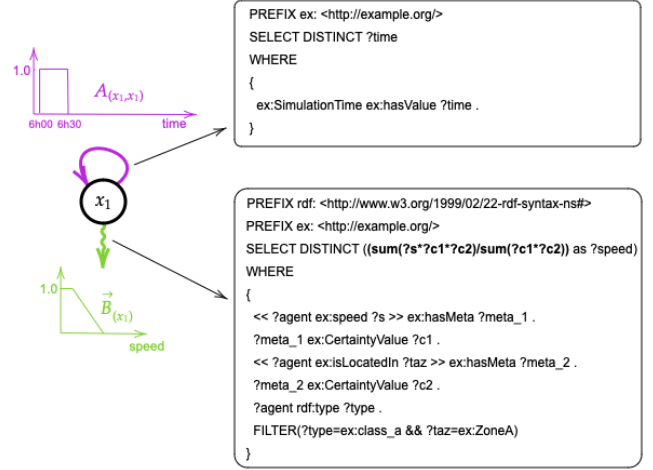

Figure 3: P-IOHMM coupled with RDF-star/SPARQL-star

Here,  $(\text{sum}(?s*?c1*?c2)/\text{sum}(?c1*?c2))$  corresponds to Equation.4. In conjunction with the RDF-star knowledge base, the performance assessment framework presented in this section offers a consistent approach to modeling and measuring the performance of urban transport systems within the range  $\in [0, 1]$  from various perspectives. This framework, therefore, facilitates their comparison and benchmarking. The following section illustrates the proposed framework using a simulated scenario in Eclipse SUMO (Simulator of Urban MObility) [24].

## 4 SIMULATION

The complete simulation workflow is shown in Figure.4. RDF-star knowledge base receives live data from SUMO, a microscopic and continuous multimodal traffic simulation tool, via the MQTT messaging protocol. SUMO was chosen as a mobility simulator for several reasons; (i) it provides full control over a running simulation through a Traffic Control Interface (TraCI) and allows to retrieve values of the simulated objects and manipulate their behaviour "online". This could be of particular interest, for example, if one wants to simulate different strategies that travellers might choose after an interruption and evaluate the impact of these behaviours on system performance [33]; (ii) TraCI also provides a socket interface that enables co-simulation. For example, OMNet++ [46] is a network simulator that can be coupled to SUMO using VEINS (Vehicles in Network Simulation [40]); (iii) in addition to the simulation of vehicles, SUMO allows the simultaneous simulation of various transportation modes such as pedestrian, bicycle, railway and waterway traffic; (iv) it includes models for pollutant emissions. [23] and (v), its community is very active. Therefore, this simulation

framework enables the simulation of a transport activity system as depicted in Figure.1.

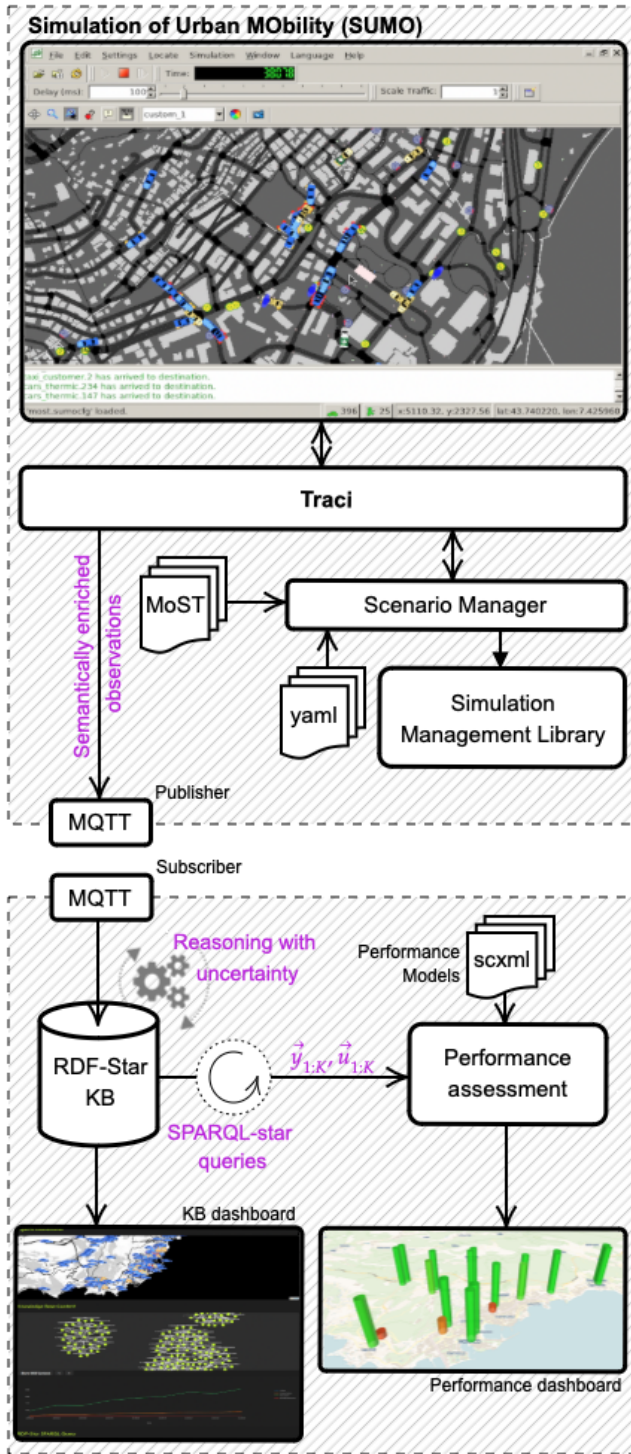

Figure 4: Urban Transport System Performance Simulation Workflow

During the simulation, several observations are gathered (see Table.1) and enriched with semantic annotations in the form of RDF-star facts. Each fact is equipped with an associated certainty value and is published to a MQTT broker on the topic corresponding to its related concern. The RDF-star knowledge base retrieves observations from each defined topic and, on a regular basis, triggers inference rules to infer new facts, as described in Section.2. SPARQL-star queries associated with  $\vec{y}$  and  $\vec{u}$  from the performance models (see Figure.3) are executed. The values  $\vec{y}$  and  $\vec{u}$  are buffered and, once the size of the buffer reaches the length  $K$ , the observation sequence  $(\vec{u}_i, \vec{y}_i)_{i=1}^K$  is passed to the performance assessment engine. A dashboard was developed that displays (i) the evolution of the knowledge base as the simulation progresses, and (ii) the evolution of performance values for each concern (i.e., performance model) within each defined TAZ.

A Python library was developed to manage various activities via the TraCI interface. The activities currently managed via the library are described below.

#### 4.1 Simulation Management Library

Evaluating the resilience of transport systems requires a comprehensive assessment that takes into account various performance indicators within human society. This includes the examination of economic, social, organisational and environmental aspects, to name but a few. To fulfil this requirement, a Python library was developed, allowing the management of the following activities and associated agents during the simulation process:

- **Taxi Fleet** - A set of taxis whose task is to pick up customers randomly distributed across the transport network during the simulation. Several taxi fleets can be defined within the simulation. Each taxi fleet is associated with the *logistic* concern, each taxi is associated with the *economic* concern and each taxi customer is associated with *social*, *environmental* and *mobility* concerns. As described in Table.1 each concern is associated with properties whose values are recorded/published throughout the simulation.
- **Bus Lines** - A series of buses travel repeatedly on predetermined routes and pick up customers at predetermined stops. The bus customers are randomly distributed to the stops and automatically diverted to the next bus on the route when the one arriving is full. The stops at which the bus customers get off are selected at random from the remaining stops on the route. Every bus customer is associated with *social*, *environmental* and *mobility* concerns.
- **Ambulance Fleet** - A set of ambulances whose task is to (i) pick up patients randomly distributed across the transport network during the simulation and (ii) drop off patients at predefined hospital locations. The longer it takes for an ambulance to arrive, the lower the patient's chances of survival. Several ambulance fleets can be defined within the simulation. Each ambulance fleet is associated with the *logistic* concern, each ambulance is associated with the *economic* concern and each patient is associated with *social*, *environmental* and *mobility* concerns.

Concern	Property	Description	Unit	Value	Time window (T)
Economic	Fleet net income	A flat-rate charge based on the number of kilometers driven and the time of day.	Euros	$\sum_{t=1}^T \sum_{agent=1}^N (i_{agent}(t))$	3600s
	Fleet fuel consumption	SUMO fuel consumption model from the HBEFA database.	ml/s	$\sum_{t=1}^T \sum_{agent=1}^N (c_{agent}(t))$	
Social	Impatience	The impatience of a driver is value between 0 and 1 that grows whenever the driver has to stop intentionally (i.e. due to a jam or waiting at an intersection).		$\max_{t=1}^T (i(t))$	60s
	Health	The health of a person is a value between 0 and 1 that decreases whenever the person waits for an ambulance.		$\min_{t=1}^T (h(t))$	
	Waiting time	The number of seconds a vehicle has a speed of less than 0.1 m/s.	s	$\max_{t=1}^T (wt(t))$	
Mobility	State	Could be 'driving', 'waiting', 'walking', etc.		Last state of the agent over T	60s
	TAZ	The Traffic Analysis Zone (TAZ) in which the agent spent the longest time during the time range T.		TAZ id	
	Speed		m/s	$\frac{1}{N} \sum_{t=1}^T (s_{agent}(t))$	
Logistic	Available assets	The number of vehicles (e.g. taxis) of the fleet not assigned a trip.		$\frac{1}{N} \sum_{t=1}^T (aa(t))$	900s
	Pending reservations	The number of reservations not satisfied.		$\frac{1}{N} \sum_{t=1}^T (pr(t))$	
Environment	CO <sub>2</sub>	Carbon dioxide	mg/s	$\sum_{t=1}^T (CO_2(t))$	60s
	CO	Carbon monoxide emission	mg/s	$\sum_{t=1}^T (CO(t))$	
	NO <sub>x</sub>	Nitrogen oxides emission	mg/s	$\sum_{t=1}^T (NO_x(t))$	
	PM <sub>x</sub>	Particulate matter emission	mg/s	$\sum_{t=1}^T (PM_x(t))$	
	HC	Hydrocarbons emission	mg/s	$\sum_{t=1}^T (HC(t))$	
	Noise		db	$\frac{1}{N} \sum_{t=1}^T (noise(t))$	

**Table 1: Concerns and their associated properties**

- **Private Vehicles** - A set of thermic cars whose point of departure is either randomly distributed across the network or assigned to a Traffic Analysis Zone (TAZ) during the simulation. Their destination is either selected at random or assigned to a TAZ, and the corresponding route is calculated dynamically. Each vehicle is associated with the *mobility*, *social* and *environmental* concerns.

There are plans for the development of additional transport activities, including freight and goods transport companies and additional modes of transport such as bicycles, electric vehicles and trains. Table 1 describes the properties that are associated with each concern the values of which are recorded/published during the simulation for each agent and each activity they are associated with during the simulation. In real life, all these properties can be retrieved from sensors in the urban transport network (e.g. environmental sensors) or from the users (e.g. smartwatches, mobile phones, etc.). The diversity of urban transport modes and the human activities they support lead to a spatial interdependence in the use of the underlying infrastructure and services. This interdependence makes urban transport systems and human activities vulnerable to cascading failures. For a meaningful assessment of the resilience of urban transport systems, it is therefore crucial to look at the performance indicators from a spatial perspective as well. To address the spatial dimension, we define Traffic Analysis Zones (TAZs). TAZs are

widely used in transport demand modelling, designed to represent the spatial distribution of trip origins and destinations while taking into account population, employment, and other spatial factors that influence travel demand [30]. The identification of the TAZs can be achieved through the analysis of *urban mobility islands*. Figure.5 presents an example of urban mobility islands, and institutional websites frequently provide data that can be used for this purpose<sup>2</sup>.

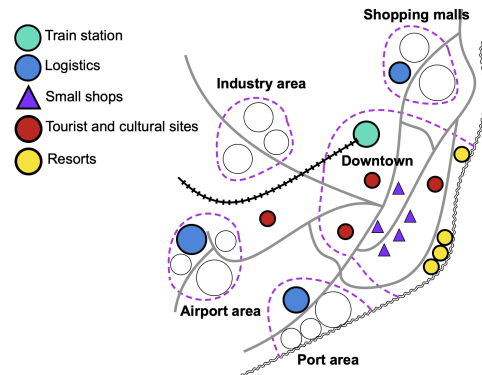

**Figure 5: Urban Mobility Islands (inspired from [37])**

<sup>2</sup><https://www.institutparisregion.fr/cartographies-interactives-cartoviz/>



As described in Table.1, the reported TAZ value corresponds to the zone in which the agent spent the most time within the time window  $T$ . A certainty level is then associated with this TAZ value as follows: let  $TAZ = T_1, \dots, T_n$  be the set of unique TAZ the agent went through during the time window  $T$ ,  $N = |TAZ|$  be the number of unique TAZs and  $d(T_i)$  be the number of times the agent went through the TAZ  $T_i$  during the time window  $T$ . The certainty value,  $C(T_i)$ , for a specific TAZ to have been visited by the agent during the time window  $T$  can be calculated using the following formula:

$$C(T_i) = \frac{d(T_i)}{\sum_{j=1}^N d(T_j)} \quad (6)$$

### 4.2 Scenario Generation Workflow

The MoST scenario [12] was used to validate the proposed approach. It consists of the transport network of Monaco city, the bus routes defined in an xml file generated from GTFS (General Transit Feed Specification) files and pre-defined TAZs. A simulation manager was developed on the basis of the library described in section.4.1. It provides means to define traffic demand distributions and the sensors that are to be linked to each activity and each agent. An example of distributions is given in Figure.6. These distributions represent the nominal transport demand, i.e. the number of vehicles, taxi customers, bus customers and patients that are instantiated over time during the simulation. They can be defined for each defined TAZ source/sink or for the entire transport network if no TAZ source/sink is defined, for each bus line, for each taxi and ambulance fleet. It is worth noting that these distributions can be obtained from institutional database<sup>3</sup>.

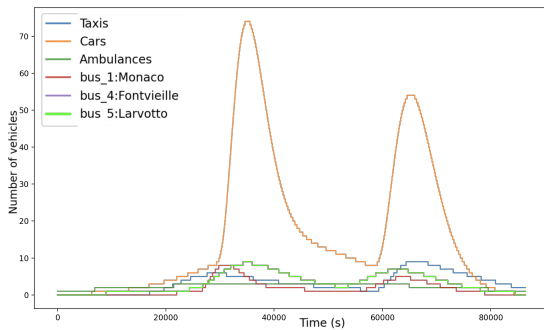

Figure 6: Traffic Demand distributions

Capturing the performance models described in Section.3 and the associated SPARQL-star queries could be a complex and time-consuming task. To facilitate the acquisition of the models, a tool was developed that creates models from recorded nominal data. Figure.7 shows an example of density kernels obtained from the simulation. It shows the  $PM_x$  and  $HC$  pollutant values recorded by bus customers on a particular bus route over time. The distributions of possibility can then be extracted for successive time windows as shown in Figure.8. The resulting model follows a Left-Right architecture, an example of which is shown in Figure.9.

<sup>3</sup><https://www.institutparisregion.fr/mobilite-et-transports/deplacements/tableau-de-bord-de-la-mobilite-en-ile-de-france/>

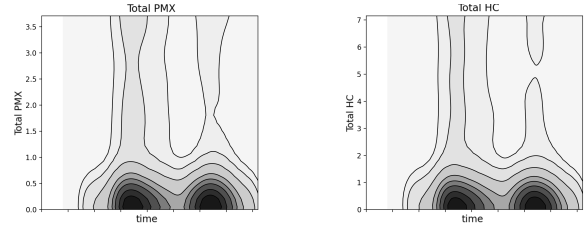

Figure 7: Density kernels of pollutant properties ( $PM_x$  and  $HC$ ) for bus customers on a particular bus line/TAZ.

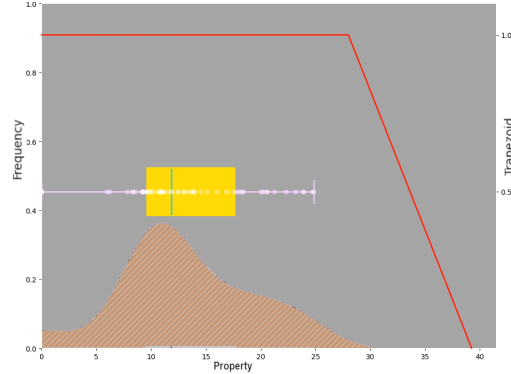

Figure 8: Example of distribution of possibility obtained from density kernels for a particular time window

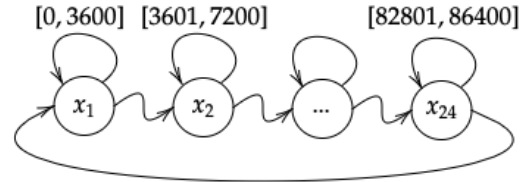

Figure 9: Left-Right P-IOH(S)MM architecture; here, time ranges are specified with seconds of the day.

These models make it possible to evaluate the performance of transport systems in the event of disruptions from various points of view. For instance, the Figure.10 depicts performance indicator values across the TAZs in the aftermath of a simulated traffic light controllers anomaly.

## 5 CONCLUSION

Urban transport systems, as critical cyber-physical infrastructure, face vulnerability to disruptions from natural disasters and malicious attacks. To ensure sustainable operation, enhancing their resilience is crucial.

Assessing the resilience of urban transport systems is complex and requires a comprehensive set of performance indicators covering different aspects of human society such as economic, social, organisational, environmental and technical aspects, taking into account

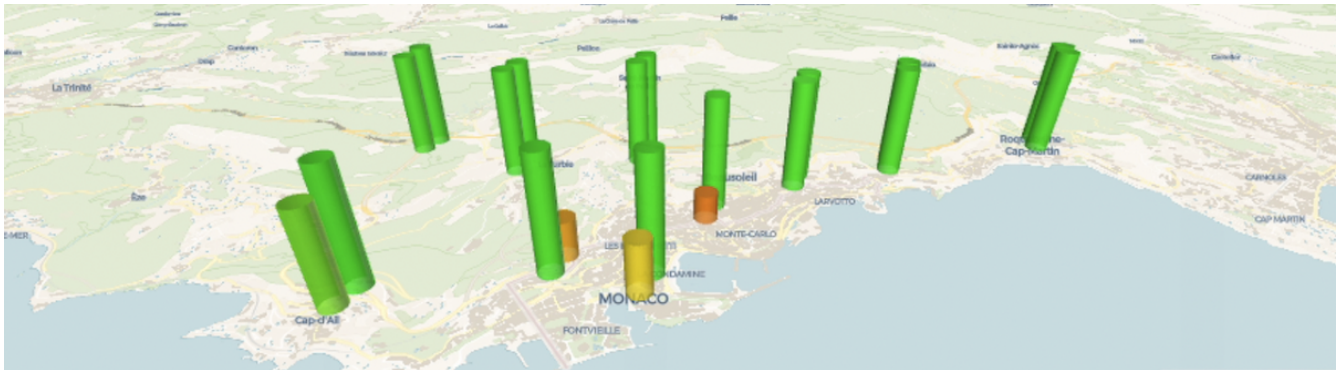

Figure 10: Performance indicators for various concerns, distributed across the TAZs.

both aleatory and epistemic uncertainties. Additionally, the interconnected nature of different transport modes and their influence on human activities necessitate incorporating the spatial dimension into performance indicators. Significant challenges hinder the evaluation of urban transport system performance. Existing resilience assessment approaches lack standardized indicator systems, leading to inconsistencies and hindering comparisons and benchmarking. This paper addresses these challenges by presenting a framework for modelling and assessing performance indicators for urban transport systems. The approach builds on an RDF-star knowledge base and its reasoning engine, which collects semantically enriched observations from the urban transport system endowed with the certainty of their values that they accurately reflect the corresponding situation in the real world. Based on this foundation, a performance indicator modeling and evaluation framework is developed on the basis of the Input/Output Hidden Semi-Markov model.

Although the proposed framework doesn't offer a standardized set of indicators, it outlines a comprehensive and unified approach for modeling and measuring performance, enabling their comparison and benchmarking. It forms the basis for future research in this area. In particular, we aim to analyze the dynamics of failure propagation and gain a deeper understanding of how these failures cascade across various areas of concern. Additionally, defining Traffic Analysis Zones (TAZs) is crucial for ensuring the validity of the performance evaluation. Different TAZs may be needed depending on the specific performance concern being evaluated. This suggests the need to explore different approaches, which will require further investigation.

## ACKNOWLEDGMENTS

Research leading to these results received funding from the EU's Horizon Europe R&I programme under grant 101070455 (DynaBIC).

## REFERENCES

- [1] 2020. Reliability in Internet of Things: Current status and future perspectives. *IEEE Internet of Things Journal* 7, 8 (2020), 6704–6721.
- [2] Craig R Allen, Hannah E Birge, David G Angeler, Craig Anthony Arnold, Brian C Chaffin, Daniel A DeCaro, Ahjond S Garmestani, and Lance Gunderson. 2018. Quantifying uncertainty and trade-offs in resilience assessments. *Ecology and Society* 23, 1 (2018).
- [3] Hamdi Aloulou, Mounir Mokhtari, Thibaut Tiberghien, Romain Endelin, and Jit Biswas. 2015. Uncertainty handling in semantic reasoning for accurate context understanding. *Knowledge-Based Systems* 77 (2015), 16–28.
- [4] Darko Andročec, Matija Novak, and Dijana Oreški. 2018. Using semantic web for internet of things interoperability: A systematic review. *International Journal on Semantic Web and Information Systems (IJSWIS)* 14, 4 (2018), 147–171.
- [5] Renzo Angles and Claudio Gutierrez. 2008. The expressive power of SPARQL. In *International Semantic Web Conference*. Springer, 114–129.
- [6] Nur Liesa Mohammad Azemi and Norfaradilla Wahid. 2021. Uncertainty in internet of things: a review. *International Journal of Advanced Technology and Engineering Exploration* 8, 75 (2021), 422.
- [7] Hamza Baqa, Nguyen Binh Truong, Noel Crespi, Gyu Myoung Lee, and Franck Le Gall. 2018. Quality of Information as an indicator of Trust in the Internet of Things. (2018), 204–211.
- [8] Sean Bechhofer, Frank Van Harmelen, Jim Hendler, Ian Horrocks, Deborah L McGuinness, Peter F Patel-Schneider, Lynn Andrea Stein, et al. 2004. OWL web ontology language reference. *W3C recommendation* 10, 2 (2004), 1–53.
- [9] Emanuele Bellini, Paolo Nesi, Cristina Martelli, Evangelia Gaitanidou, Francesco Archetti, Antonio Candelieri, Jan-Paul Leuteritz, Pedro Ferreira, and Laura Cocone. 2023. Building Resilient and Sustainable Cities Starting from the Urban Transport System. In *Urban Resilience: Methodologies, Tools and Evaluation: Theory and Practice*. Springer, 49–74.
- [10] Damien Bouchabou, Sao Mai Nguyen, Christophe Lohr, Benoit LeDuc, and Ioannis Kanellos. 2021. A survey of human activity recognition in smart homes based on IoT sensors algorithms: Taxonomies, challenges, and opportunities with deep learning. *Sensors* 21, 18 (2021), 6037.
- [11] Fernando Castaño, Stanislaw Strzelczak, Alberto Villalonga, Rodolfo E Haber, and Joanna Kossakowska. 2019. Sensor reliability in cyber-physical systems using internet-of-things data: A review and case study. *Remote sensing* 11, 19 (2019), 2252.
- [12] Lara Codeca and Jérôme Härrri. 2018. Monaco SUMO traffic (MoST) scenario: A 3D mobility scenario for cooperative ITS. *EPIC Series in Engineering* 2 (2018), 43–55.
- [13] Ivette Raices Cruz. 2021. Robust analysis of uncertainty in scientific assessments. (2021).
- [14] Vasiliki Demertzi, Stavros Demertzis, and Konstantinos Demertzis. 2023. An Overview of Cyber Threats, Attacks and Countermeasures on the Primary Domains of Smart Cities. *Applied Sciences* 13, 2 (2023), 790.
- [15] Shuiguang Deng, Hailiang Zhao, Weijia Fang, Jianwei Yin, Schahram Dustdar, and Albert Y Zomaya. 2020. Edge intelligence: The confluence of edge computing and artificial intelligence. *IEEE Internet of Things Journal* 7, 8 (2020), 7457–7469.
- [16] LAPJ Gonçalves and PJG Ribeiro. 2020. Resilience of urban transportation systems. Concept, characteristics, and methods. *Journal of Transport Geography* 85 (2020), 102727.
- [17] Amelie Gyrard, Soumya Kanti Datta, and Christian Bonnet. 2018. A survey and analysis of ontology-based software tools for semantic interoperability in IoT and WoT landscapes. (2018), 86–91.
- [18] Olaf Hartig. 2017. Foundations of RDF\* and SPARQL\*-(An alternative approach to statement-level metadata in RDF). In *AMW 2017 11th Alberto Mendelzon International Workshop on Foundations of Data Management and the Web, Montevideo, Uruguay, June 7-9, 2017.*, Vol. 1912. Juan Reutter, Divesh Srivastava.
- [19] Sitti Asmah Hassan, Hamzah Amalina Amlan, Nor Eliza Alias, Mariyana Aida Ab-Kadir, and Nur Sabahiah Abdul Sukor. 2022. Vulnerability of road transportation networks under natural hazards: A bibliometric analysis and review. *International Journal of Disaster Risk Reduction* 83 (2022), 103393.
- [20] Antonio J Jara, Alex C Olivieri, Yann Bocchi, Markus Jung, Wolfgang Kastner, and Antonio F Skarmeta. 2014. Semantic web of things: an analysis of the application semantics for the iot moving towards the iot convergence. *International Journal*

- of *Web and Grid Services* 10, 2-3 (2014), 244–272.
- [21] Aimad Karkouch, Hajar Mousannif, Hassan Al Moatassime, and Thomas Noel. 2016. Data quality in internet of things: A state-of-the-art survey. *Journal of Network and Computer Applications* 73 (2016), 57–81.
- [22] Maria Koliou, John W van de Lindt, Therese P McAllister, Bruce R Ellingwood, Maria Dillard, and Harvey Cutler. 2020. State of the research in community resilience: Progress and challenges. *Sustainable and resilient infrastructure* 5, 3 (2020), 131–151.
- [23] Daniel Krajzewicz, Michael Behrisch, Peter Wagner, Raphael Luz, and Mario Krumnow. 2015. Second generation of pollutant emission models for SUMO. In *Modeling Mobility with Open Data: 2nd SUMO Conference 2014 Berlin, Germany, May 15-16, 2014*. Springer, 203–221.
- [24] Daniel Krajzewicz, Jakob Erdmann, Michael Behrisch, and Laura Bieker. 2012. Recent development and applications of SUMO-Simulation of Urban MOBility. *International journal on advances in systems and measurements* 5, 3&4 (2012).
- [25] Jieun Lee and JaeSeung Song. 2023. Towards Semantic Smart Cities: A Study on the Conceptualization and Implementation of Semantic Context Inference Systems. *Sensors* 23, 23 (2023), 9392.
- [26] Camila Maestrelli Leobons, Vânia Barcellos Gouvêa Campos, and Renata Albergaria de Mello Bandeira. 2019. Assessing urban transportation systems resilience: a proposal of indicators. *Transportation research procedia* 37 (2019), 322–329.
- [27] Wenbin Li, Giuseppe Tropea, Ahmed Abid, Andrea Detti, and Franck Le Gall. 2019. Review of standard ontologies for the web of things. (2019), 1–6.
- [28] Alexandre K Ligo, Alexander Kott, and Igor Linkov. 2021. How to measure cyber-resilience of a system with autonomous agents: Approaches and challenges. *IEEE Engineering Management Review* 49, 2 (2021), 89–97.
- [29] Zongmin Ma, Guanfeng Li, and Ruizhe Ma. 2022. Fuzzy RDF Modeling. (2022), 71–107.
- [30] Eric J Miller. 2021. Traffic analysis zone definition: Issues & guidance. *Travelling Modelling Group; University of Toronto: Toronto, ON, Canada* (2021), 1–22.
- [31] Mohamed Nasserredine and Alex Khang. 2024. Applications of Internet of Things (IoT) in smart cities. In *Advanced IoT Technologies and Applications in the Industry 4.0 Digital Economy*. CRC Press, 109–136.
- [32] Lorena Otero-Cerdeira, Francisco J Rodríguez-Martínez, and Alma Gómez-Rodríguez. 2015. Ontology matching: A literature review. *Expert Systems with Applications* 42, 2 (2015), 949–971.
- [33] Shouzheng Pan, Hai Yan, Jia He, and Zhengbing He. 2021. Vulnerability and resilience of transportation systems: A recent literature review. *Physica A: Statistical Mechanics and its Applications* 581 (2021), 126235.
- [34] Amar Rayes and Samer Salem. 2019. (2019).
- [35] Gérald Rocher, Jean-Yves Tigli, and Stéphane Laviolette. 2021. A Generic Clustering-Based Algorithm for Approximating IOHMM Topology and Parameters. *IEEE Access* 9 (2021), 79491–79504.
- [36] Gérald Rocher, Jean-Yves Tigli, Stéphane Laviolette, and Nhan Le Thanh. 2018. A possibilistic i/o hidden semi-markov model for assessing cyber-physical systems effectiveness. In *2018 IEEE International Conference on Fuzzy Systems (FUZZ-IEEE)*. IEEE, 1–9.
- [37] Jean-Paul Rodrigue. 2020. *The geography of transport systems*. Routledge.
- [38] Florian Schmidt, Matteo Ceriotti, Niklas Hauser, and Klaus Wehrle. 2015. If you can't take the heat: Temperature effects on low-power wireless networks and how to mitigate them. (2015), 266–273.
- [39] MZ Serdar, M Koç, and SG Al-Ghamdi. 2021. Urban transportation networks resilience: indicators, disturbances, and assessment methods. *Sustain Cities Soc* 76: 103452.
- [40] Christoph Sommer, David Eckhoff, Alexander Brummer, Dominik S Buse, Florian Hagenauer, Stefan Joerer, and Michele Segata. 2019. Veins: The open source vehicular network simulation framework. *Recent Advances in Network Simulation: The OMNeT++ Environment and its Ecosystem* (2019), 215–252.
- [41] Wenjuan Sun, Paolo Bocchini, and Brian D Davison. 2020. Resilience metrics and measurement methods for transportation infrastructure: The state of the art. *Sustainable and Resilient Infrastructure* 5, 3 (2020), 168–199.
- [42] Shital A Thekdi and Joost Santos. 2019. Decision-making analytics using plural resilience parameters for adaptive management of complex systems. *Risk Analysis* 39, 4 (2019), 871–889.
- [43] Dominik Tomaszuk. 2016. Inference rules for RDF (S) and OWL in N3Logic. *arXiv preprint arXiv:1601.02650* (2016).
- [44] Cassia Trojahn, Renata Vieira, Daniela Schmidt, Adam Pease, and Giancarlo Guizzardi. 2022. Foundational ontologies meet ontology matching: A survey. *Semantic Web* 13, 4 (2022), 685–704.
- [45] Pierre-Yves Vandenbussche, Ghislain A Ateazing, María Poveda-Villalón, and Bernard Vatant. 2017. Linked Open Vocabularies (LOV): a gateway to reusable semantic vocabularies on the Web. *Semantic Web* 8, 3 (2017), 437–452.
- [46] Andras Varga. 2019. A practical introduction to the OMNeT++ simulation framework. *Recent Advances in Network Simulation: The OMNeT++ Environment and its Ecosystem* (2019), 3–51.
- [47] R Vesse. 2010. dotNetRDF Documentation. Available at: [https://github.com/dotnetrdf/dotnetrd/wiki/UserGuide-Getting-Started,\(Last Accessed 10/01/2019\)](https://github.com/dotnetrdf/dotnetrd/wiki/UserGuide-Getting-Started,(Last%20Accessed%2010/01/2019)) (2010).
- [48] Jens Weigel and Karsten Tolle. 2024. Handling Uncertainty in RDF Graphs for numismatic Use Cases. (2024).
- [49] Zhuyu Yang, Bruno Barroca, Aurélia Bony-Dandrieux, and H  l  ne Dolidon. 2022. Resilience indicator of urban transport infrastructure: a review on current approaches. *Infrastructures* 7, 3 (2022), 33.
- [50] Zhuyu Yang, Bruno Barroca, Alexandre Weppe, Aur  lia Bony-Dandrieux, Katia Laffr  chine, Nicolas Daclin, Val  rie November, Khaled Omrane, Daouda Kamisoko, Frederick Benaben, et al. 2023. Indicator-based resilience assessment for critical infrastructures—A review. *Safety science* 160 (2023), 106049.
- [51] Andrea Zanella, Nicola Bui, Angelo Castellani, Lorenzo Vangelista, and Michele Zorzi. 2014. Internet of things for smart cities. *IEEE Internet of Things Journal* 1, 1 (2014), 22–32.