



HAL
open science

Experimental Evaluation and Numerical Modeling of Wide-Flange Steel Columns Subjected to Constant and Variable Axial Load Coupled with Lateral Drift Demands

Julien Cravero, Ahmed Elkady, Dimitrios Lignos

► **To cite this version:**

Julien Cravero, Ahmed Elkady, Dimitrios Lignos. Experimental Evaluation and Numerical Modeling of Wide-Flange Steel Columns Subjected to Constant and Variable Axial Load Coupled with Lateral Drift Demands. *Journal of Structural Engineering*, 2020, 146 (3), pp.2499. 10.1061/(ASCE)ST.1943-541X.0002499. hal-04672340

HAL Id: hal-04672340

<https://hal.science/hal-04672340>

Submitted on 18 Aug 2024

HAL is a multi-disciplinary open access archive for the deposit and dissemination of scientific research documents, whether they are published or not. The documents may come from teaching and research institutions in France or abroad, or from public or private research centers.

L'archive ouverte pluridisciplinaire **HAL**, est destinée au dépôt et à la diffusion de documents scientifiques de niveau recherche, publiés ou non, émanant des établissements d'enseignement et de recherche français ou étrangers, des laboratoires publics ou privés.



Distributed under a Creative Commons Attribution 4.0 International License

1 **Experimental Evaluation and Numerical Modeling of Wide-Flange Steel Columns** 2 **Subjected to Constant and Variable Axial Load Coupled with Lateral Drift Demands**

3
4 Julien Cravero¹; Ahmed Elkady²; and Dimitrios G. Lignos³, M. ASCE
5

6 **Abstract:** This paper presents results from an experimental evaluation on the pre- and post-
7 buckling behavior of 12 steel wide-flange cantilever columns under axial load and lateral drift
8 demands. The influence of several loading and geometric parameters, including the cross-sectional
9 local web and flange slenderness ratios, applied axial load, and lateral and axial loading history on
10 the performance of these columns is thoroughly examined. The test data indicate that cross-
11 sectional local buckling is highly asymmetric in steel columns under variable axial load. A
12 relatively high compressive axial load can significantly compromise the steel column seismic
13 stability and ductility but this also depends on the imposed lateral loading history. The AISC axial
14 load-bending moment interaction equation provides accurate estimates of a steel column's yield
15 resistance. However, the same equation underestimates by at least 30% the column's peak
16 resistance regardless of the loading scenario. Measurements of column flange deformation, axial
17 shortening, flexural resistance and lateral drift are combined in a single graphical format aiding the
18 process of assessing steel column repairability after earthquakes. The test data suggest that current
19 practice-oriented nonlinear component modeling guidelines (PEER/ATC 2010) may not provide
20 sufficient accuracy in establishing both the monotonic and first-cycle envelope curves of steel
21 columns. It is also shown that high-fidelity continuum finite element models shall consider
22 geometric imperfections of proper magnitude in addition to the steel material inelasticity to
23 properly simulate the inelastic buckling of wide-flange steel columns and generalize the findings
24 of physical tests. Issues arising due to similitude are also discussed to properly limit steel column
25 instability modes in future studies.

¹ PhD candidate, HMCO|Navier, Ecole des Ponts ParisTech, Champs-sur-Marne, France. E-mail: julien.cravero@enpc.fr

² Postdoctoral research scientist, RESSLab, ENAC, Swiss Federal Institute of Technology, Lausanne (EPFL), Lausanne, Switzerland. E-mail: ahmed.elkady@epfl.ch

³ Associate professor, RESSLab, ENAC, Swiss Federal Institute of Technology, Lausanne (EPFL), Lausanne, Switzerland. E-mail: dimitrios.lignos@epfl.ch

26 **Keywords:** Steel columns; Large-scale testing; Axial shortening; Axial load carrying capacity;
27 Column repairability curve; Nonlinear modeling of steel columns; ATC 72; Continuum finite
28 element models; Scale effects

29 **Introduction**

30 Steel columns are essential structural components in preventing earthquake-induced collapse
31 of steel frame buildings. For this purpose, capacity design principles are employed to limit inelastic
32 energy dissipation to selected structural fuses, such as steel beams in steel moment-resisting frames
33 (MRFs) or steel braces in concentrically braced frames (CBFs). However, first-story steel MRF
34 columns near their base are still likely to experience inelastic rotation demands due to the
35 deformation kinematics of a full-frame yield mechanism. Albeit capacity-design protection is
36 applied, steel frame buildings may still experience unanticipated column plastic hinging at higher
37 stories due to force redistributions occurring after the onset of component deterioration in strength
38 and stiffness (Lignos et al. 2011b; Lignos et al. 2013; Tirca et al. 2015; Stoakes and Fahnestock
39 2016; Nakashima et al. 2018) or due to higher mode effects (Gupta and Krawinkler 2000; Alavi
40 and Krawinkler 2004; Tremblay 2018).

41 Although columns in prospective steel MRF designs typically experience modest axial load
42 demands of up to 30% of their axial yield strength, P_y , (NIST 2010a; Elkady and Lignos 2014;
43 Suzuki and Lignos 2014; Elkady and Lignos 2015b), in existing steel MRF tall buildings, their
44 columns may experience axial load demands on the order of 50%~70% P_y (Bech et al. 2015;
45 Akcelyan and Lignos 2018). From a retrofit perspective, it may be challenging to retain a cost
46 efficiency because the ASCE 41 standard (ASCE 2014) would treat these columns as forced-
47 controlled elements (i.e., zero plastic deformation capacity), regardless of their respective local
48 cross-sectional and member slenderness geometric properties. This assumption was mostly
49 justified based on research conducted in the early 1970s on small-scale column specimens (Popov
50 et al. 1975). However, recent work (Newell and Uang 2006; Elkady and Lignos 2016; Ozkula et
51 al. 2017; Elkady and Lignos 2018a, b) suggests that the same assumption may not be justifiable
52 for “stocky” wide-flange columns with web slenderness ratios $h/t_w < 20$ and member slenderness
53 ratios $L_b/r_y \leq 80$ (L_b is the column’s unbraced length; r_y is the cross-section’s radius of gyration
54 with respect to its weak-axis). However, available experimental data on steel columns subjected
55 to high compressive axial load demands ($\geq 0.5P_y$) coupled with lateral drift demands is still scarce
56 to further substantiate a potential change of the corresponding limit for force-controlled elements
57 as well as the current ANSI/AISC 360-16 (AISC 2016) axial compressive limit of $0.75P_y$ for the
58 plastic design of steel columns with plastic hinges. This data could also be potentially useful for

59 the seismic design of steel CBF columns. Although these are primarily subjected to high axial load
60 demands, the column flexural demands could considerably increase due to the non-uniform
61 inelastic drift demands along the steel CBF height (Toutant et al. 2017).

62 From a reparability stand point, FEMA P58 (FEMA 2009a) provides recommendations for
63 typical repair measures and their cost estimates for damage states associated with flexural yielding,
64 cross-sectional local buckling and weld fracture in the aftermath of earthquakes. However, these
65 are mostly applicable to steel beams in fully restrained beam-to-column connections. Although
66 some of these measures (e.g. heat straightening) may be applicable to steel columns, these repairs
67 could become challenging due to potential residual axial shortening (MacRae et al. 1990; Ozkula
68 et al. 2017; Elkady et al. 2018; Elkady and Lignos 2018a). Depending on the cross-sectional
69 slenderness, the reserve capacity of a steel column after a seismic event may not necessarily be
70 much depending on the imposed lateral drift demands.

71 From a nonlinear modeling stand point, current guidelines for performance-based seismic
72 design and assessment (LATBSDC 2017; PEER 2017) of new and existing steel buildings
73 necessitates the use of component hysteresis models of varying complexities to properly trace the
74 onset of geometric instabilities (e.g. local buckling and lateral torsional buckling) that could
75 significantly compromise the structural behavior at ultimate limit states. This is also an apparent
76 necessity to properly characterize the collapse risk of prospective designs that consider new lateral
77 load resisting systems based on formally established collapse risk-assessment methodologies
78 (FEMA 2009b). Current guidelines (PEER/ATC 2010) facilitating the above needs, mainly cover
79 modeling recommendations for concentrated plasticity phenomenological deterioration models
80 (e.g., Ibarra et al. 2005) due to their computational efficiency. These recommendations were
81 primarily benchmarked to experimental data from fully restrained beam-to-column connections
82 that became available after the 1994 Northridge earthquake (FEMA 2000; Lignos and Krawinkler
83 2011, 2013). Therefore, their applicability to the nonlinear modeling of steel columns shall be
84 carefully examined since PEER/ATC (2010) modeling guidelines neglect important loading (e.g.,
85 axial load) and geometric parameters (e.g., L_b/r_y) that may significantly affect the column behavior
86 under cyclic loading. The need for more monotonic test data in addition to the ones based on
87 reversed cyclic loading is also apparent (Haselton et al. 2008; Krawinkler 2009; Maison and
88 Speicher 2016). The reason is that a monotonic backbone curve, which is considered as a unique
89 property of a structural component, is typically used to benchmark models that explicitly capture

90 component cyclic deterioration in strength and stiffness for use in nonlinear dynamic analysis
91 ([Lignos and Krawinkler 2011](#); [Hamburger et al. 2018](#)).

92 Furthermore, with computational advancements and the use of high-performance computing,
93 high fidelity continuum finite element (CFE) models are used more and more in explicit collapse
94 simulations of steel frame buildings ([Miyamura et al. 2015](#); [Wu et al. 2018a](#)). Despite of the
95 associated computational cost, challenges in this case arise on how to reliably trace the onset and
96 progression of geometric instabilities, as well as the potential coupling of different instability
97 modes, in an explicit manner such that cyclic deterioration in flexural and axial strength of the
98 column can be reliably predicted. Several modeling proposals are available regarding the above
99 matters ([Newell and Uang 2006](#); [Elkady and Lignos 2015a](#); [Araújo et al. 2017](#); [Elkady and Lignos](#)
100 [2018b](#); [Wu et al. 2018b](#)) with conflicting recommendations. In that respect, column physical
101 experiments can benchmark various modeling options and provide coherent recommendations for
102 high fidelity CFE modeling. These models could significantly expand the range of available steel
103 column data by considering a broader range of parameters and configurations that may not be
104 feasible to be physically tested. As such, experiments and complementary CFE simulations can
105 address future challenges regarding the seismic design of steel structures ([Uang and Bruneau 2018](#)).

106 With the goal of further comprehending the hysteretic behavior of wide-flange steel columns
107 to address most of the above challenging issues, this paper summarizes the findings from an
108 experimental program involving 12 large-scale wide flange steel columns tested in a cantilever
109 fashion. The specimens are approximately two-thirds of full-scale as compared to columns used
110 in typical steel frame buildings designed in seismic regions. The loading schemes comprise
111 monotonic and reversed cyclic lateral drifts coupled with relatively high constant and variable
112 axial load demands. The tests reported herein are part of a broader research study that examines
113 the seismic stability of steel columns due to local and member instabilities, considering the
114 development and validation of component modeling techniques of various fidelities for the seismic
115 assessment of steel members and structures.

116 **Description of the Test Program**

117 [Table 1](#) summarizes the test matrix parameters. Three cross-sections are utilized: W14x61
118 (Group A), W16x89 (Group B) and W14x82 (Group C). Each group includes four nominally
119 identical specimens. These sizes are representative of first-story columns in mid-rise MRFs (4 to

120 8 stories) at a two-third scale. The W14x82 and W16x89 cross-sections satisfy the ANSI/AISC
121 341-16 (AISC 2016a) compactness limits for highly ductile members, λ_{hd} , regardless of the applied
122 compressive axial load ratio, P/P_y (P is the applied axial load; P_y is based on the measured
123 geometric and material properties of a specimen). These two cross-sections have similar flange
124 slenderness ratios ($b_f/2t_f = 5.9$) but different web slenderness ratios. The W14x61 cross-section has
125 a flange slenderness ratio ($b_f/2t_f = 7.8$) slightly higher than the ANSI/AISC 341-16 flange
126 compactness limit for highly ductile members ($\lambda_{hd} = 7.2$).

127 The test specimens, which were manufactured from three different steel heats, are fabricated
128 from ASTM (2015) A992 Grade 50 steel (nominal yield stress, $f_{yn} = 345\text{MPa}$). The material
129 properties and chemical composition based on the mill certificate are summarized in Table 1 and
130 Table 2, respectively. The same table reports the measured steel material properties based on
131 uniaxial tensile coupon testing (ASTM 2014). The reported values are the average ones from three
132 coupons extracted from a cross-section's web and flanges. In brief, the steel materials in Groups
133 A, B, and C have a measured yield stress, f_y , that is 6%, 9%, and 16% larger than the nominal one,
134 respectively. These values are consistent with the expected-to-nominal yield stress ratio, R_y , of 1.1
135 for ASTM A992 Grade 50 steel (AISC 2016a).

136 Figure 1 shows the overall test setup used for the experimental testing of cantilever steel column
137 specimens. The setup comprises a 12MN high capacity vertical actuator and a 1MN horizontal
138 actuator with a $\pm 250\text{mm}$ stroke. In-plane bracing is employed as shown in Fig. 1 to provide in-
139 plane lateral stability to the 12MN vertical actuator. Both actuators are connected, through axially
140 rigid links, to a high precision structural pin at the column specimen's top end. This pin represents
141 a column's inflection point at mid-height by assuming idealized fixed-end boundary conditions at
142 both column ends. Two running beams (noted as guide beams) provide lateral stability bracing at
143 the column specimen's top end. Referring to Fig. 2, the column specimens have a clear length, L ,
144 of 1750mm and a base-to-pin length of 2150mm. End plates are welded at both column ends with
145 complete joint penetration (CJP) J-groove welds as shown in Fig. 2. The welds were inspected
146 with ultrasonic testing to ensure that potential defects were below the allowable limits as per AWS
147 (2009). The weld access holes are designed as per Section J1.6 of AISC (2016b) to ensure
148 minimum stress concentrations at the current weld location.

149 The test program incorporates three lateral loading protocols. These include: i) a monotonic
150 protocol to obtain the monotonic backbone curve of each column specimen at representative

151 gravity-induced axial load ratios and ii) the standard [AISC \(2016a\)](#) symmetric cyclic protocol
152 ([Clark et al. 1997](#)), which is commonly used in the pre-qualification of fully restrained beam-to-
153 column connections. In an effort to reduce the total testing time, the symmetric protocol was
154 slightly modified by reducing the number of elastic cycles at the 0.375%, 0.5% and 0.75% drift
155 amplitudes (see [Fig. 3a](#)). Lastly, a collapse-consistent lateral loading protocol ([Suzuki and Lignos](#)
156 [2014](#)) is also employed to investigate the influence of the lateral loading history (i.e., cumulative
157 damage) on a steel column's hysteretic behavior (see [Fig. 3b](#)). This protocol represents the seismic
158 demands in steel MRF columns at large deformations associated with structural collapse ([Ibarra](#)
159 [and Krawinkler 2005](#); [Lignos et al. 2011a](#)). If after the first loading phase, the steel column flexural
160 resistance is still higher than 50% of its peak flexural resistance, then this protocol is repeated as
161 shown in [Fig. 3b](#). The lateral drift protocols are coupled with constant compressive axial load ratios
162 of 0.3 and 0.5 (see [Table 1](#)). A higher axial load ratio of 0.75 was also used to re-assess the
163 ASCE/SEI 41-13 ([ASCE 2014](#)) axial load limit for force-controlled elements. Although this axial
164 load demand largely exceeds that expected in steel MRFs ([Elkady and Lignos 2014](#); [Suzuki and](#)
165 [Lignos 2014](#)), it could be representative in steel CBF columns ([Toutant et al. 2017](#)). The symmetric
166 cyclic lateral loading protocol is synchronized with variable axial load demands representing the
167 loading conditions of steel MRF end columns due to dynamic overturning effects (i.e., transient
168 axial load component). The first axial load protocol has a gravity offset, P_g , of $0.30 P_y$ and a
169 transient component, P_v , of $\pm 0.45 P_y$ (i.e., reaching $0.15 P_y$ in tension and $0.75 P_y$ in compression
170 as shown in [Fig. 3c](#)). The second one involves a gravity load offset of $0.50 P_y$ and a transient
171 component of $\pm 0.25 P_y$ (see [Fig. 3d](#)). The imposed axial loading protocols are fairly conservative
172 because after the onset of column geometric instabilities, the axial load demands are typically
173 relaxed due to force redistributions ([Suzuki and Lignos 2014](#)).

174 **Instrumentation and Deduced Column Response Parameters**

175 A total of 27 uniaxial strain gauges are installed on each specimen's web and flanges near their
176 column base over a length of $1.6 d$ (d is the column depth) to track the onset of flexural yielding
177 and plastic strain progression. String potentiometers are used to monitor the in-plane lateral
178 displacement as well as the axial shortening, Δ_{axial} , of a column's top end. Linear variable
179 differential transformers (LVDTs) and inclinometers, installed on a specimen's bottom base plate
180 confirmed the assumption of the fixed end boundary since there was no indication of base plate

181 slip and uplift during the tests. Light-emitting diode (LED) targets are used to track the out-of-
182 plane displacements (δ_{op}) along the column height as shown in Fig. 4. These are also used to track
183 the in-plane displacement of the flange tips (δ_f), which is later on used to assess the feasibility of
184 column repair following earthquakes.

185 Fig. 5 shows the deduced end moment versus the column's chord rotation for all the specimens.
186 Similarly, Fig. 6 shows their axial shortening history versus the column chord rotation. Referring
187 to Fig. 5, the end moment, M , is computed as the summation of the actuators' force components,
188 in the global coordinate system, multiplied by the corresponding lever arms to the top surface of
189 the column base and considering the rigid body rotation of the top pin assembly. The moment is
190 then normalized with respect to the plastic bending resistance, M_p of the corresponding cross-
191 section. The M_p is based on the measured geometric and material properties of the respective test
192 specimen. Figure 7 shows the out-of-plane column displacement, δ_{OP} , and the in-plane flange tip
193 displacement, δ_f , histories versus the chord rotation for selected column specimens as defined in
194 Fig. 4. In Figs 5, 6 and 7 and the subsequent discussion, the chord rotation, θ , is defined as the in-
195 plane lateral displacement at the column top over its clear length, L . In the subsequent sections, a
196 qualitative and quantitative assessment of the steel damage progression is presented including
197 critical aspects associated with the steel column stability under monotonic and cyclic loading.

198 **Qualitative Summary of Column Behavior**

199 The typical damage sequence of a wide-flange steel column often leading up to the complete
200 loss of its axial-load carrying capacity is illustrated in Fig. 8. During small elastic cycles there is
201 no evident deformation in a test specimen. Referring to Fig. 8a, flexural yielding in the column
202 web and flanges typically occurs at chord rotations ranging from 0.25% to 0.65% radians,
203 depending on the cross-section and the imposed axial load demand. This is visually observed
204 through peeling of the mill-scale at the column surface. Shear yielding is also evident in the web
205 (see Fig. 8a). Upon further lateral loading, the column's fixed end experiences local buckling. The
206 peak of the corresponding local buckling wave is observed at a distance of 0.4 to 0.8 d measured
207 from the column base, as seen in Fig. 8b. The local buckling mode(s) and corresponding
208 amplitudes are mainly dependent on the imposed lateral drift history. In particular, specimens
209 subjected to monotonic and collapse-consistent lateral loading histories experience asymmetric
210 local buckling (Fig. 8b). Drifting in one loading direction (Ibarra and Krawinkler 2005) dominates

211 the column response, thereby leading to asymmetric local buckling. On the other hand, columns
212 subjected to a symmetric cyclic lateral loading history coupled with a constant compressive axial
213 load experience symmetric local buckling as indicated in Fig. 8c. This damage pattern is consistent
214 even in cases that although the axial load varies it always remains compressive. Asymmetric local
215 buckling occurs if the axial load demand fluctuates from compression to tension. The reason why
216 the local buckling shape becomes asymmetric in this case is due to neutral-axis shifting that tends
217 to straighten the buckling wave in one of the two loading directions (see Fig. 8e). At larger drift
218 excursions ($\geq 3\%$) a second buckling wave often develops at a distance of 0.8 to 1.6 d ; hence, a
219 full sinusoidal buckling wave is noticeable (see Figs. 8d and 8e). This second buckling wave is
220 accompanied with large out-of-plane displacements near the column's dissipative zone as shown
221 in Fig. 8f. At a lateral drift of 3%, the out-of-plane displacements of the column plastic hinge
222 reaches about 20mm (1.0% L). at this point, the in-plane flange tip displacement is on the order of
223 40mm (see Fig. 7). The magnitude of these displacements affects the repair actions in steel
224 columns in the aftermath of earthquakes as well as the column's reserve capacity that could be of
225 interest in mainshock-aftershock earthquake series. The above issues are carefully examined in a
226 subsequent section. Referring to Fig. 8f, the observed out-of-plane instability mode is typically
227 followed by a rapid loss of the column's axial load carrying capacity. This is typically accelerated
228 under a high compressive axial load and/or a high web slenderness ratio. Notably, specimens A4,
229 B3 and C4 experienced a sudden loss of their axial load carrying capacity. In particular, in
230 specimen C4 (subjected to $0.75 P_y$), axial shortening grew rapidly from 110mm to 170mm (6% to
231 9% L) within few seconds (see Fig. 6i). This indicates the member inability to carry the imposed
232 axial load demand due to the associated instability mode. Referring to Fig. 5i, this corresponds to
233 a complete loss of the column's flexural resistance.

234 **Quantitative Assessment of Column Behavior**

235 The previous section summarized a number of qualitative features characterizing the behavior
236 of steel columns under lateral drift and axial load demands. This section provides a quantitative
237 assessment of the column hysteretic behavior by considering a number of performance indicators
238 including the cyclic deterioration in a column's flexural resistance, the column axial shortening
239 and the associated plastic hinge length. The influence of the axial load variation on a column's
240 hysteretic response is carefully examined. Issues related to similitude for experimental testing of

241 steel columns are also investigated by means of comparisons with experimental data from prior
242 column testing programs. Finally, based on a synthesis of experimental results, the concept of a
243 column's repairability curve is introduced that may facilitate decision-making for steel column
244 repairs in the aftermath of earthquakes.

245 **Column Flexural Resistance**

246 [Figure 5](#) shows the moment-rotation relation of the tested specimens. Steel columns experience
247 flexural strength deterioration due to local buckling-induced softening regardless of the employed
248 loading conditions and cross-sectional geometric properties. This is attributed to the relatively
249 small member slenderness ratios ($L_b/r_y < 30$) in all cases. Only in few cases, plastic lateral torsional
250 buckling is coupled with local buckling but only at large drift demands. For instance, for specimen
251 B2 (W16x89, $P/P_y=0.5$), this only occurred after 8% radians under monotonic loading resulting
252 into a steeper negative stiffness in the post-peak response (see [Fig. 5d](#)).

253 Under monotonic lateral loading (see [Figs. 5a, 5d, 5g](#)), the tendency for local buckling initiation
254 decreases with decreasing local web and/or flange slenderness ratios, resulting in increased pre-
255 peak plastic rotation capacities, θ_p (difference between chord rotation at the peak response minus
256 the corresponding column yield rotation). This effect is somewhat pronounced with decreased
257 compressive axial load ratio because a larger portion of the web cross-section experiences tensile
258 stresses at a given lateral drift demand, thereby providing restraint against web local buckling.
259 [Figures 5a](#) and [5b](#) suggest that when local buckling is the primary instability mode of wide-flange
260 steel columns (e.g., Specimens A1, A2 and B1), they attain a residual plateau due to local buckling
261 length stabilization ([Krawinkler et al. 1983](#)). On the other hand, column specimens experiencing
262 coupled local and lateral torsional buckling under monotonic loading (e.g., Specimen B2) attain a
263 second steeper negative stiffness soon after the onset and progression of local buckling. Although
264 inconclusive, this implies that wide flange beam-columns experiencing coupled geometric
265 instabilities under monotonic loading do not necessarily reach to a residual flexural resistance
266 because a buckling length stabilization path cannot be attained. [Figures 5g](#) and [5d](#) indicate that
267 although the local and member slenderness ratios of W16x89 and W14x82 columns are nearly the
268 same (see [Table 1](#)), the former has a θ_p of about 4% while the latter has a θ_p of more than 7% at a
269 given compressive axial load demand. This implies that the respective steel material has a strong
270 influence on the steel column plastic deformation. Albeit all columns are fabricated from

271 nominally identical A992 Gr. 50 steel, the chemical composition of Group C include a notably
272 larger percentage of Manganese than that of Groups A and B (see Table 2). This strongly
273 influences the steel material hardenability (Shirasawa et al. 1981; Bruneau et al. 2011) and in turn
274 the plastic deformation capacity of a steel member prior to the formation of local buckling. In
275 particular, specimens C1 and C2 hardened monotonically much more than specimens A1, A2, B1
276 and B2 as shown in Figs 5g, 5a and 5d, respectively.

277 Referring to Fig. 5, the hysteretic behavior of wide-flange steel columns under cyclic lateral
278 loading is primarily governed by local buckling in their post-peak response. Columns that are
279 subjected to a constant compressive axial load ratio ($P/P_y \geq 0.5$), experience accelerated cyclic
280 deterioration in their flexural resistance after the onset of local buckling. Although most columns
281 maintained their flexural resistance at a lateral drift of 2%, the ones subjected to a symmetric cyclic
282 lateral loading history lost their axial load carrying capacity at a lateral drift of 4% regardless of
283 their local slenderness ratios. This is mostly attributed to the relatively large number of inelastic
284 drift cycles of a symmetric cyclic lateral loading history. Notably, a W14x61 column (Specimen
285 A3), which is moderately compact as per ANSI/AISC 341-16, maintained close to 80% of its
286 flexural resistance up to a lateral drift demand of 6% when subjected to a collapse-consistent lateral
287 loading protocol (see Fig. 5b). This indicates the strong influence of the imposed lateral loading
288 history on the steel column hysteretic response.

289 Column specimens subjected to variable axial load demands developed a fully asymmetric
290 hysteretic behavior (see Figs. 5c and 5f). In particular, while the compressive axial load increases
291 in an absolute sense due to the transient axial load demand in addition to the gravity-induced one,
292 the flexural negative stiffness in a column's post-peak response becomes relatively steep. On the
293 other hand, while a column experiences reduced compressive axial load demand in the opposite
294 lateral loading direction, its flexural resistance does not practically deteriorate. This is attributed
295 to local buckling straightening. Notably, the measured data corresponding to Figs. 5c and 5f should
296 be interpreted as lower bounds of a column's behavior under variable axial load demands. The
297 reason is that the imposed axial load demands are relaxed due to force redistributions occurring
298 within a steel frame building experiencing structural damage. This relaxation may reach up to 50%
299 of the initial axial load demand (Suzuki and Lignos 2014, 2015b).

300 **Assessment of Axial Force – Bending Interaction Curves**

301 The experimental data set covers a wide range of axial load demands, offering the opportunity
302 to evaluate the existing axial force-bending (P-M) interaction curves of current code provisions.
303 [Figure 9](#) shows the ANSI/AISC 360-16 ([AISC 2016](#)) P-M interaction curve. The vertical and
304 horizontal axes are normalized with respect to the available axial and flexural strengths, P_c and M_c ,
305 respectively, according to [AISC \(2016b\)](#). In this computation, the resistance ϕ factors and the
306 measured material properties are considered. The following parameters were also assumed: an
307 effective length in the weak-axis direction $L_c=875\text{mm}$, an unbraced length $L_b=L=1750\text{mm}$ and a
308 lateral-torsional buckling modification factor $C_b=1.67$. In all cases, M_c was controlled by the yield
309 limit state (i.e., $M_c = \phi M_p$). Shown in the same figure are all the measured P-M data points when
310 first yield occurred at the extreme fiber ([Fig. 9a](#)) and at the maximum attained moment ([Fig. 9b](#)).
311 Referring to [Fig. 9a](#), the P-M interaction curve adequately predicts the flexural resistance at first
312 yield in almost all cases that the axial load demand is constant. The first yield moment of specimens
313 A4 and B4 is 30% larger than that predicted by the P-M interaction curve. This is because the P-
314 M interaction curve does not depict the influence of axial load variation on the flexural resistance
315 of these columns. Finally, specimen C4 (W14x82, $P/P_y=0.75$) also developed a higher flexural
316 resistance than what is predicted by the P-M interaction curve. However, if the full length member
317 was considered, then member (flexural) buckling could have been the primary instability mode in
318 this case considering the high compressive axial load demand imposed on this column.

319 Vis-à-vis the above discussion, the P-M interaction curve according to the ANSI/AISC 360-16
320 provisions seems rational for predicting a beam-column's flexural resistance at first yield.
321 However, this is not the case for the column's maximum attained moment (see [Fig. 9b](#)) regardless
322 of the imposed compressive axial load demand. In particular, the P-M interaction curves were
323 derived analytically considering beam-columns without acknowledging any hardening (i.e., elastic
324 perfectly-plastic material assumption) ([ASCE 1971](#); [Bruneau et al. 2011](#)). [Figure 9b](#) underscores
325 the influence of the kinematic and isotropic hardening on M_{max} . This is more evident in columns
326 with more compact cross-sections (Groups B and C), in which M_{max} is underestimated by at least
327 30% and 40%, respectively. The delay in the local buckling formation leads to an appreciable
328 amount of cyclic hardening. This is not so apparent in steel columns with moderately ductile cross-
329 sections (i.e., Group A) due to the early onset of geometric instabilities after flexural yielding. The
330 general consensus is that a thorough re-assessment of the P-M interaction curves for steel beam-

331 columns used in seismic applications shall be conducted, which agrees with recent related work
332 (Zeimian et al. 2018). Such an assessment is outside the scope of the present paper.

333 **Column Axial Shortening**

334 Figure 6 shows the column axial shortening versus the corresponding column chord rotation.
335 Previous studies (MacRae et al. 1990; Elkady and Lignos 2018a, b) found that axial shortening is
336 strongly correlated with a steel column's cumulative inelastic rotation demands. Thus, specimens
337 subjected to monotonic lateral loading (see Figs. 6a, 6d, 6g) exhibit only minor axial shortening
338 of up to 30mm (i.e., 1.4% L) regardless of the cross-section web slenderness ratio and the imposed
339 compressive axial load. In contrast, specimens subjected to symmetric cyclic lateral loading
340 shorten by up to 110mm (6% L) due to the large number of inelastic drift cycles. The higher the
341 web slenderness ratio the larger the column axial shortening because the column web becomes
342 more susceptible to local buckling-induced softening.

343 Although specimen C4 was subjected to a $P/P_y=0.75$, it shortened more-or-less by the same
344 amount with specimen C3 that was subjected to $P/P_y=0.5$ (see Fig. 6i versus Fig. 6h). This implies
345 that the neutral-axis position of the cross-section strongly influences the corresponding column
346 axial shortening. In particular, in the above two cases, due to the high compressive axial load, the
347 neutral axis always remained outside the cross-section. As such, the cross-section's entire web
348 experienced compressive stresses throughout the imposed lateral drift history. MacRae et al.
349 (2009) found that the column axial shortening is practically not influenced by the applied
350 compressive axial load if $P/P_y > A_w/A$ (in which, A_w and A are the web area and gross cross-section
351 area, respectively). The experimental results suggest that this mechanistic assumption holds true
352 for end steel MRF columns experiencing transient axial load demands if the imposed axial load
353 ratio is still above the threshold value of A_w/A despite of the corresponding axial load variation
354 range. In particular, referring to Figs. 6e and 6f, Specimens B3 ($P/P_y=0.5$) and B4
355 ($P_g/P_y=0.5 \pm P_v/P_y=0.25$) are subjected to the same lateral drift histories but considerably different
356 axial load demands. Nonetheless, they both experienced nearly the same axial shortening due to
357 the aforementioned reason.

358 **Effect of Transient Axial Load**

359 [Figure 10](#) shows the history of axial load ratio variation versus the column axial shortening,
360 Δ_{axial} , for two specimens (A4 and B4). In order to quantify their axial stiffness deterioration, the
361 instantaneous stiffnesses, K_{axial}^- and K_{axial}^+ , corresponding to the beginning and the end of each
362 lateral drift loading excursion, respectively, are extracted as illustrated in [Figs. 10a](#) and [10b](#). The
363 $K_{axial}^{+/-}$ values are normalized with respect to the elastic axial stiffness, $K_{axial,el}$, of the respective
364 column based on measured geometric and material properties (i.e., $K_{axial,el}=EA/L$). Accordingly,
365 the normalized axial stiffness is shown [Figs. 10c-d](#), for the first excursion of each drift level of the
366 employed lateral loading protocol. In both cases, the axial stiffness deteriorates rapidly right after
367 the onset of web and flange local buckling of column specimens A4 and B4. This is more evident
368 in the negative loading direction once the compressive axial load reaches 75% P_y
369 ($K_{axial}^+/K_{axial,el}=54\%$ and 34% for specimen A4 and B4, respectively). While the lateral drift
370 progresses, the rate of axial stiffness degradation stabilizes until the axial load carrying capacity is
371 lost ($K_{axial}^+=0$). This limit state is depicted relatively well in [Fig. 10a](#) for Specimen A4. On the
372 other hand, Specimen B4 lost its axial load carrying capacity during the last lateral loading
373 excursion as shown in [Fig. 10b](#). To the best of the authors knowledge, the data presented herein is
374 unique and can facilitate the calibration of mechanics-based numerical models that explicitly
375 capture axial stiffness degradation as well as column axial shortening ([Suzuki and Lignos 2017](#);
376 [Do and Filippou 2018](#); [Kolwankar et al. 2018](#)).

377 **Plastic Hinge Length**

378 [Figure 11a](#) shows the measured plastic hinge length, L_{PH} , for all the column specimens. The
379 plastic hinge length is defined as the length between the column base plate and the last cross-
380 sectional level experiencing plastic strains. The latter is deduced through linear interpolation
381 between the strain gauges measurements. From this figure, the W14x61 and W16x89 specimens
382 developed an L_{PH} of 1.6~2.0 d . The stockier W14x82 specimens developed a fairly large L_{PH} of
383 2.0~2.6 d . The spread of yielding at the column base relates to the steel material hardening ([Kanno](#)
384 [2016](#)) and the corresponding cross-section local slenderness ratio. In particular, if the onset of local
385 buckling is delayed, then the spread of plasticity becomes large for mild steels exhibiting combined
386 kinematic/isotropic hardening. This is the reason for the notable differences between the measured
387 plastic hinge length between specimens in Group C and Groups A and B. While all three steel
388 heats were nominally the same (i.e., A992 Gr. 50), the chemical composition of the Group C steel

389 material includes a notably larger percentage of Manganese. As stated earlier, this influences the
390 steel material hardenability (Shirasawa et al. 1981; Bruneau et al. 2011) and in turn the extent of
391 plastic hinge length of a steel member.

392 Figure 11a suggests that the employed lateral loading protocol has a negligible effect on the
393 column plastic hinge length (e.g. specimen B2 versus B3 and similarly C2 versus C3). On the other
394 hand, the presence of high compressive axial load demands augments the plastic hinge length. The
395 resultant second-order moment due to the compressive axial load pushes the center of local
396 buckling further away from the column base, thereby increasing the associated plastic hinge length.
397 This is schematically illustrated in Fig. 11b. In particular, specimens A2 and B2 ($P/P_y=0.5$)
398 developed a 12% larger plastic hinge length compared to specimens A1 and B1 ($P/P_y=0.3$),
399 respectively. Similarly, specimen C2 developed a plastic hinge length that is 30% larger than
400 specimen C1. The above observations reflect the findings from prior related experimental studies
401 (Nakashima et al. 1990; Peng et al. 2008; Suzuki and Lignos 2015a; Elkady and Lignos 2016).

402 Also superimposed in Fig. 11a is the predicted L_{PH} values based on the Elkady and Lignos
403 (2018b) empirical model. This model was developed based on high-fidelity CFE simulations of
404 steel columns under cyclic loading. In particular, the proposed empirical model relates L_{PH} to the
405 web slenderness ratio, h/t_w , the member slenderness ratio, L_b/r_y , and the compressive axial load
406 ratio, P/P_y . Although the empirical model predicts relatively well the plastic hinge length of Group
407 A and B specimens, it underestimates L_{PH} by 40%, on average, for the Group C specimens. This
408 is primarily related to the associated variability in material-hardening properties that is not
409 captured by this empirical model. Notably, the observed plastic hinge lengths of Groups A and B
410 are in a reasonable agreement with the minimum L_{PH} of $1.5 d$ specified in the New Zealand
411 standards, NZS 3404 (SNZ 2007), for Category 1 and 2 members (equivalent to highly ductile
412 members per ANSI/AISC 341-16).

413 Vis-à-vis the above discussion, the experimental results facilitate the identification of the
414 potential plastic hinge length of a steel column for member stability verifications.

415 Section Classification and Scale Effects

416 In general, deep wide-flange steel columns ($d > 400\text{mm}$) are prone to geometric instabilities
417 associated with local and/or lateral torsional buckling (NIST 2010b). In a recent testing program
418 (Elkady and Lignos 2018a), the second and third authors tested a 4m long fixed-end column with

419 a deep W24x146 cross-section under symmetric cyclic loading combined with a constant $P/P_y=0.5$.
420 This specimen had a comparable web and flange local slenderness ratio with specimen C3
421 (W16x89) tested herein. The out-of-plane movement/rotation restraint in the full-scale and
422 cantilever specimen was enforced by two actuators and flexurally-rigid steel beams, respectively.
423 This was additionally checked using measurements from a wireless displacement tracking system.
424 Strain and deformation measurements confirmed as well that the inflection point in the full-scale
425 specimen remained at the column mid-height throughout the test (see [Elkady and Lignos 2018a](#)).
426 Accordingly, the results from both specimens are directly comparable and the only differences in
427 the measured response can be attributed to similitude; hence, the “deep-column” effect on the steel
428 column stability can be properly characterized. Issues related to similitude for future experimental
429 studies related to the seismic stability and ductility of steel columns can be highlighted. The pre-
430 dominant instability mode in both specimens was local buckling-induced softening followed by
431 column axial shortening ([Elkady and Lignos 2018a](#)) as indicated in [Figs. 12a and 12b](#). In particular,
432 [Fig. 12c](#) shows a comparison of the normalized moment-rotation relations of the two specimens.
433 Although both specimens reached to a comparable normalized peak moment, the W24x146
434 column experienced local buckling early on in the lateral loading history compared to the W16x89
435 steel column. This is attributed to the restraint that the flange provides to the web against local
436 buckling. In particular, the web of the W24x146 cross-section is less restrained by the flanges
437 against local buckling compared to the W16x89 cross-section. For the same reason, at any given
438 drift following the onset local buckling, column axial shortening in the W24x146 column was
439 about 2 times larger than that of the W16x89 column as shown in [Fig. 12d](#). This simple comparison
440 highlights the need to re-define the cross-sectional compactness limits in future design provisions
441 by acknowledging the interaction between the web and flanges rather than treating those limits as
442 an individual plate rule whereas the section classification limits are determined by comparing the
443 most slender plate between the web and flange with the respective codified slenderness limits
444 ([Chen et al. 2013](#)).

445 A side aspect to be thought through carefully is the proper scaling selection to characterize the
446 hysteretic behavior of deep columns. Prior studies ([Zargar et al. 2014](#)) attempted to characterize
447 the behavior of deep columns through relatively small-scale experiment. Although informative,
448 the observed instability modes in these studies departed from the observed ones at full-scale. While
449 lateral torsional buckling was observed in both cases, column axial shortening due to progression

450 of column web buckling was not depicted at all due to similitude. Moreover, the damage
451 progression, local and member instability synergistic action was not traced. Similar issues have
452 been raised in fracture-related problems when fracture toughness is transferred from lab- to real-
453 scale components (Pericoli and Kanvinde 2018).

454 **Column Repairability Curves**

455 The feasibility of conducting column repairs in the aftermath of earthquakes can be typically
456 decided based on the extent of damage represented by the magnitude and size of the local buckling
457 wave (FEMA 2009a). The experimental program discussed herein as well as prior physical testing
458 of wide-flange steel columns (MacRae et al. 1990; Newell and Uang 2006; Suzuki and Lignos
459 2015b; Ozkula et al. 2017; Elkady and Lignos 2018a) highlight that steel columns may experience
460 significant residual axial shortening. This could compromise the steel column repairability.
461 Moreover, from a structural safety stand point, another compelling issue is the reserve capacity of
462 a steel column after a mainshock. Reconnaissance reports indicate that aftershocks could often be
463 quite damaging leading to structural collapse (Clifton et al. 2011; Okazaki et al. 2013).

464 In this regard, the concept of “Column Repairability Curve” is introduced herein to integrate all
465 the aforementioned damage indicators into a single compact graphical format to facilitate the
466 decision-making for steel column repair actions in the aftermath of earthquakes. Figure 13 shows
467 such curves for different column specimens experiencing both asymmetric (see Figs. 13a, 13b)
468 and symmetric local buckling (see Fig. 13c) near the column base. These curves combine three
469 interdependent column performance indicators with the column lateral drift demand, θ . In
470 particular, these indicators include the normalized residual flexural resistance of a steel column as
471 a function of the peak flexural resistance, M_{max} (top horizontal axis); the corresponding column
472 axial shortening, Δ_{axial} (right vertical axis); and the flange tip displacement, δ_f , indicating the local
473 buckling wave amplitude (left vertical axis). This displacement is extracted from LED
474 measurements shown in Fig. 7. Note that in the column repairability curves, axes are not in scale.

475 Referring to Figs. 13a and 13b, for columns experiencing asymmetric buckling, the
476 corresponding flange tip displacement is almost double the column residual axial shortening. At
477 lateral drift demands of 2% (representative of a design-basis earthquake), column repairability by
478 means of straightening and/or strengthening the buckled region is feasible considering that both δ_f
479 and Δ_{axial} are less than 10mm. Although the corresponding residual flexural resistance of these

480 columns at a 2% drift demand is at least 70% M_{max} , this loss can be restored with the above repair
481 measures. Referring to Fig. 13c, for columns experiencing symmetric local buckling, Δ_{axial} and δ_f
482 are nearly the same. Due to the exponential increase of residual axial shortening, a column may
483 practically be unrepairable after 2% radians. It is acknowledged that the repairability assessment
484 is subject to an expert's opinion as well as the building characteristics and regional design practices.
485 The column repairability curves presented herein are indicative and can provide a quantitative
486 assessment of a steel column's damage state if the expected lateral drift demands can be somehow
487 estimated. These curves can also be used as a tool to quickly estimate the lateral drift demands as
488 well as the flexural resistance loss if physical measurements of the flange tip displacement and/or
489 column residual shortening are conducted after an earthquake. Alternatively, one can utilize
490 multivariate damage fragility functions such as those developed by Elkady et al. (2018). These
491 functions relate pre-described levels of column residual strength and axial shortening (i.e., damage
492 states), to the column's web slenderness, axial load demand and story-drift ratio demand.

493 **Assessment of Nonlinear Modeling Recommendations for Wide Flange Steel Columns**

494 **PEER/ATC 72-1 Modeling Guidelines**

495 PEER/ATC 72-1 (PEER/ATC 2010) provides engineering practice-oriented nonlinear
496 modeling guidelines for structural steel components for the nonlinear seismic performance
497 assessment of existing and prospective structural designs. These guidelines employ idealized
498 concentrated plasticity component models for use in nonlinear static and response-history analyses
499 of frame structures. These recommendations are largely based on physical testing of steel beams
500 in fully restrained beam-to-column connections (FEMA 2000; Lignos and Krawinkler 2011). Due
501 to lack of column test data at the time, it is common that the same recommendations are used for
502 the nonlinear modeling of wide-flange steel columns. In particular, PEER/ATC 72-1 *Option 1*
503 defines the input model parameters for the monotonic backbone curve of a steel structural
504 component. This is treated as a unique property of the structural component and shall be used with
505 hysteretic component models that explicitly simulate cyclic deterioration in strength and stiffness
506 (Ibarra et al. 2005; Krawinkler 2009; Lignos and Krawinkler 2011). Alternatively, in order to
507 conduct a nonlinear static analysis, PEER/ATC 72-1 *Option 3* modeling option is employed. This
508 represents the first-cycle envelope curve of a structural component subjected to a symmetric cyclic
509 lateral loading protocol. This curve, which is loading history dependent, only captures implicitly

510 the influence of cyclic deterioration on a component's strength and stiffness. The above nonlinear
511 modeling options are evaluated herein based on direct comparisons with the gathered experimental
512 data. To facilitate the subsequent discussion, selected comparisons are established based on tests
513 conducted under monotonic (see Figs. 14a and 14b) and cyclic lateral loading (see Figs. 14c, 14d).

514 **Elastic Effective Stiffness, K_e**

515 Referring to Fig. 14, the PEER/ATC 72-1 modeling guidelines tend to overestimate the elastic
516 stiffness, K_e , of wide-flange steel columns because the contribution of the shear deformations is
517 neglected in the K_e computation. In principle, a member's total lateral deformation can be
518 expressed as $\delta_{total} = \delta_b(1+\beta)$ in which, δ_b is the flexural deformation; and β is the bending-to-shear
519 stiffness ratio ($\beta = K_b/K_s$). For cantilever members, K_b and K_s are calculated as $3EI/L$ and GAL/α ,
520 respectively, where I is the moment-of-inertia about the strong-axis, G is the shear modulus and α
521 is the cross section's shear coefficient as per Cowper (1966). For instance, when the shear stiffness
522 is infinitely large ($K_s=\infty$), β approaches zero implying no shear deformations. For the range of
523 cross-sections summarized in Table 1, α was found to be about 0.25, which corresponds to a 25%
524 increase of a column's elastic deformation. Figure 15 summarizes the ratio of the theoretically-
525 computed stiffness to the measured one from 152 wide-flange steel column experiments (Popov
526 et al. 1975; MacRae et al. 1990; Nakashima et al. 1990; Newell and Uang 2006; Cheng et al.
527 2013a; Cheng et al. 2013b; Suzuki and Lignos 2015b; Ozkula et al. 2017; Elkady and Lignos
528 2018a) including the test data presented herein. The figure shows that K_e is overestimated, on
529 average, by 30% when shear deformations are neglected. Accordingly, it is recommended that
530 shear deformations be considered when computing a wide-flange steel column's effective stiffness,
531 K_e . The corresponding formula for estimating the elastic effective stiffness of energy-dissipative
532 links in eccentrically braced frames would suffice for this purpose (Bech et al. 2015; Lignos et al.
533 2019).

534 **Effective Yield Strength, M_y^* , and Capping Strength, M_{max} ,**

535 The PEER/ATC 72-1 modeling *Options 1* and 3 compute the corresponding effective yield
536 strength as $M_y^* = 1.1 Z f_{ye} (1-P/P_y)$ where, Z is the cross-section plastic modulus about the strong-
537 axis; and f_{ye} is the expected yield stress. The predicted M_y^* tends to underestimate the measured
538 one as demonstrated in Fig. 14. This is attributed to (a) the axial load-bending interaction that is

539 only considered approximately from the equation above; and (b) the corresponding material cyclic
540 hardening that is inherently captured by the coefficient 1.1 (Lignos and Krawinkler 2011). The
541 former can be easily noted from Figs. 14a and 14b representing specimens subjected to $P/P_y =$
542 30% and 50%. The latter is justified from a comparison of the first-cycle envelopes of nominally
543 identical specimens subjected to a symmetric and a collapse-consistent lateral loading history as
544 shown in Figs, 14c and 14d, respectively. In particular, due to the relatively small number of
545 inelastic cycles prior to the onset of local buckling, cyclic hardening is not as pronounced as it is
546 in the case of a symmetric cyclic lateral loading history. As such, the predicted M_y^* is nearly the
547 same with the measured one (see Fig. 14d).

548 The PEER/ATC 72-1 modeling guidelines suggest a constant capping-to-effective-yield
549 strength ratio, M_{max}/M_y^* , of 1.1 that depicts the effects of material hardening on the post-yield
550 behavior of a structural steel component. Albeit this value is fairly constant for steel beams due to
551 the absence of axial load demands (Lignos and Krawinkler 2011), the test data herein indicate that
552 M_{max}/M_y^* varies from 1.1 to 1.7 for Group A and B specimens; and up to 2.4 for Group C specimens.
553 In particular, Group B and C specimens involve cross-sections with fairly compact webs, thereby
554 delaying the onset of local buckling which in turn translates into a relatively high hardening ratio,
555 $M_{max}/M_y^* = 1.5$. Accordingly, for nonlinear phenomenological component modeling, M_{max}/M_y^* shall
556 be computed by considering the cross-sectional slenderness and the corresponding axial load
557 demand (Lignos et al. 2019).

558 **Pre- and post-peak Plastic Rotations**

559 Figures 16a and 16b summarizes the pre- (θ_p) and post-peak (θ_{pc}) plastic rotations, respectively,
560 of the 12 tested column specimens. These values are deduced based on idealized trilinear curves
561 fitted to the monotonic backbone and first-cycle envelope curves of each column specimen.
562 Superimposed in the same figures are the computed values based on the PEER/ATC 72-1 modeling
563 guidelines (both *Options 1* and *3*). Although the test data highlight the dependence of the achieved
564 plastic rotation capacities on the cross-sectional local slenderness ratios and the applied axial load
565 demand, the predicted values depict the former but not the latter effect. As noted earlier, the
566 PEER/ATC 72-1 *Option 1* equations were developed based on test data from steel beams (i.e., zero
567 axial load). As such, the computed values tend to overestimate the measured ones based on
568 monotonic loading by at least 20%, when $P/P_y > 0.3$ and/or the corresponding cross-sectional web

569 slenderness, $h/t_w > 25$. With regards to column specimens subjected to symmetric cyclic lateral
570 loading, *Option 3* systematically overestimates both θ_p and θ_{pc} values by at least 50%. Noteworthy
571 stating that for Specimen A3, which was subjected to a collapse-consistent lateral loading history,
572 the predicted θ_{pc} value was well correlated with the measured one. This suggests the need for more
573 refined lateral loading protocols for component modeling and acceptance criteria of structural
574 components (Suzuki and Lignos 2014; Maison and Speicher 2016).

575 **Continuum Finite Element Modeling Recommendations for Wide-Flange Steel Columns**

576 High-fidelity CFE models can be effectively utilized to simulate the onset and progression of
577 geometric instabilities associated with local and/or lateral torsional buckling in wide-flange steel
578 columns under monotonic and cyclic loading. A number of recommendations are available for this
579 purpose in the literature (Newell and Uang 2006; Elkady and Lignos 2015a; Fogarty and El-Tawil
580 2015; Araújo et al. 2017; Elkady and Lignos 2018b) with conflicting conclusions. In particular,
581 Elkady and Lignos (2015a, 2018b) and Fogarty and El-Tawil (2015) suggest that local and member
582 geometric imperfections (GIs) are of equal importance to properly simulate the onset of geometric
583 instabilities due to local and lateral torsional buckling along a steel column that utilizes slender
584 cross-sections. Others suggest that GIs are only important for properly simulating the monotonic
585 behavior of steel beam-columns but not the cyclic one (Araújo et al. 2017). A more recent study
586 (Wu et al. 2018a) suggested that GIs shall not be used for modeling the hysteretic behavior of deep
587 and slender steel columns such that pre-selected bifurcation paths can be avoided. In prior studies
588 (Newell and Uang 2006), GIs were neglected but these were not deemed to be critical for
589 simulating the hysteretic behavior of columns utilizing stocky cross-section profiles. This section
590 clarifies several of the aforementioned concepts in an intrinsic effort to provide guidance for CFE
591 nonlinear modeling of steel columns. For this purpose the commercial finite element software
592 ABAQUS-FEA/CAE (2011) is utilized with the following assumptions; The large deformation
593 simulations employ quadratic shell elements with reduced integration (S4R) that are deemed to
594 adequately trace geometric instabilities (Elkady and Lignos 2015a, 2018b). Material nonlinearity
595 is considered with the Von Mises yield surface and a multiaxial plasticity model (Voce 1948;
596 Armstrong and Frederick 1966; Lemaitre and Chaboche 1975), which was calibrated to uniaxial
597 cyclic coupon tests of (ASTM 2015) A992 Gr. 50 steel (Suzuki and Lignos 2017) of similar
598 microstructure and chemical composition with the steel materials discussed herein. The material

599 model parameters are loading history independent (Elkady and Lignos 2018b; Sousa and Lignos
600 2018). Two types of analyses are conducted with (w) and without (w/o) triggering local and
601 member imperfections (GIs) based on conventional buckling analysis. The amplitude of local
602 imperfections in the flanges and the web are set to $b_f/250$ and $h_w/250$, respectively, based on
603 imperfection measurements conducted in prior testing programs (Elkady and Lignos 2016; Elkady
604 and Lignos 2018a) for a similar range of cross-section profiles with the ones discussed herein. The
605 above geometric imperfections are within the manufacturing limits of wide-flange products
606 (ASTM 2014). Note that desired GIs shape and amplitude are achieved by scaling and
607 superimposing the different local buckling modes of the column model. For more details, the
608 reader is referred to Elkady and Lignos (2018b).

609 Figure 17 shows sample comparisons between the CFE predictions and the test data of
610 representative specimens to address the above issues. Referring to Figs. 17a and 17b, the
611 agreement between the simulated and measured responses is noteworthy when GIs are considered
612 both for monotonic and cyclic lateral loading. The same figure also shows the simulated results
613 when local GIs are not incorporated in the CFE model. The results suggest that the CFE simulation
614 model in this case overestimates by at least a factor of two the flexural resistance and plastic
615 deformation capacities of steel columns under monotonic and/or cyclic loading. These simple
616 comparisons suggest that CFE simulation models shall (a) properly consider the combined
617 kinematic/isotropic hardening of mild steels and (b) always incorporate GIs of proper magnitude
618 to accurately trace the onset of local and/or lateral torsional buckling of steel wide-flange beam-
619 columns. Recommendations developed by the second and third author (Elkady and Lignos 2018b)
620 can facilitate this effort. These agree with recent modeling recommendations on how to model
621 complex three-dimensional behavior of steel members (Zeimian et al. 2018).

622 **Summary and conclusions**

623 This paper discusses in detail the main findings from an experimental program that
624 characterized the behavior of wide-flange steel columns under monotonic and reversed cyclic
625 lateral loading coupled with high constant and variable axial load demands. The tests were
626 conducted with 1800mm long cantilever test specimens. Test parameters included the cross-
627 section local slenderness, the applied axial load ratio (constant versus variable) as well as the lateral
628 loading history. The test program also offered the opportunity to assess the state-of-the-art

629 recommendations for models of various computational resolutions including concentrated
630 plasticity and high-fidelity continuum finite element (CFE) approaches.

631 The typical damage progression of the test specimens involved flexural yielding followed by
632 cross-sectional local buckling regardless of the employed loading history. Due to the relatively
633 small member slenderness, L_b/r_y , of the test specimens, global instabilities (i.e., lateral torsional
634 and/or flexural buckling) were not evident at lateral drift amplitudes of up to 7% even at high axial
635 load demands ($P/P_y > 0.5$). The local buckling mode was fairly symmetric in test specimens under
636 symmetric lateral loading histories coupled with constant compressive axial load. On the other
637 hand, wide-flange steel columns subjected to asymmetric lateral loading or variable axial load
638 demands (that varies between compression and tension) developed an asymmetric local buckling
639 mode. The plastic hinge region varies from $1.6 d$ to $2.5 d$ with the center of local buckling moving
640 away from the column base with higher compressive loads. However, this becomes insensitive to
641 the compressive axial load ratio if this becomes larger than a threshold equal to web-to-total cross-
642 section area ratio.

643 Under monotonic lateral drift, the test results suggest that steel columns subjected to modest
644 axial load demands ($P/P_y = 0.30$) attain a residual flexural strength due to stabilization of the
645 developed cross-sectional local buckling length. On the other hand, steel columns under high axial
646 load demands ($P/P_y \geq 0.5$) typically attain a secondary negative stiffness at large lateral
647 deformations due to coupling of local and lateral torsional buckling. In any case, the loss of a
648 column's axial load carrying capacity is accompanied by severe axial shortening.

649 Columns subjected to high axial load demands and reversed cyclic lateral loading deteriorate
650 in flexural resistance rapidly after a reference lateral drift of 2%. In fact, most of the tested
651 specimens lost their axial load carrying capacity at a lateral drift of 4%. Nonetheless, the test results
652 underscore the influence of the imposed lateral loading history on the column's plastic deformation
653 capacity. Although inconclusive, seismic acceptance criteria should eventually consider the
654 cumulative plastic rotation demands in addition to a reference plastic deformation.

655 The hysteretic behavior of steel columns under variable axial load demands is highly
656 asymmetric. The increased compressive axial load due to the transient effects causes local buckling
657 initiation at the column flange experiencing the highest compressive stresses. In the opposite
658 loading direction, the flexural resistance of the column is maintained to at least 80% of the
659 maximum attained moment even at lateral drift demands of up to 4% due to local buckling

660 straightening In this case, the experimental results shall be interpreted as lower bound responses
661 because the imposed variable axial loading histories conservatively ignored the redistribution of
662 axial forces within a steel frame building once its structural members enter into the inelastic regime.
663 This issue deserves much attention in future experimental studies.

664 The ANSI/AISC 360-16 (AISC 2016b) axial load–bending (P-M) interaction curve predicts
665 relatively well the first flexural yielding of all the test specimens. However, the peak column
666 flexural resistances of the specimens were at least 30% larger than those predicted by the P-M
667 interaction equation, regardless of the imposed axial load demand. This is due to the fact that this
668 interaction curve does not acknowledge the post-yield hardening of typical mild steel materials
669 (i.e., assumption of elastic-perfectly plastic material). This assumption seems to work well for steel
670 columns utilizing moderately ductile cross-sections as per ANSI/AISC 341-16 (AISC 2016a) that
671 develop a negligible amount of cyclic hardening due to the early occurrence of local buckling. At
672 high compressive axial load demands ($P/P_y \geq 0.75$) the P-M interaction shall be carefully evaluated
673 based on prospective tests with column specimens prone to member buckling.

674 The experimental data summarized herein also served for the validation of state-of-the-art
675 component modeling guidelines (PEER/ATC 2010) widely used by the engineering profession for
676 the seismic performance assessment of existing and prospective steel building designs. In
677 particular, the PEER/ATC 72-1 *Option 1* and *3* component models were thoroughly assessed. The
678 former defines the monotonic backbone curve of a structural component, while the latter defines
679 its first-cycle envelope curve based on experiments conducted with standard symmetric cyclic
680 lateral loading histories. In particular, both *Option 1* and *3* models tend to underestimate a
681 column's elastic lateral stiffness by up to 30% when shear deformations are neglected. The
682 effective flexural strength, M_y^* , is only predicted well for column specimens subjected to modest
683 axial load demands of $0.30P_y$ representative of steel MRF columns. Although the post-yield
684 hardening ratio, M_c/M_y^* , could range anywhere from 1.1 to 1.5 depending on the imposed axial
685 load demand and the cross-sectional web local slenderness, the PEER/ATC 72-1 component
686 models assume a constant value of 1.1, which is typical for steel beams (i.e., zero axial load ratio)
687 with slender but seismically compact cross-sections (Lignos and Krawinkler 2011). Similarly, the
688 PEER/ATC 72-1 *Option 1* model predicts reasonably well the monotonic backbone curve of wide-
689 flange steel columns under modest axial load demands ($0.30P_y$) and whose web slenderness ratios
690 are within the calibration range of the *Option 1* model ($20 < h/t_w < 55$). In cases that $P/P_y > 0.30$

691 and $h/t_w > 25$, the *Option 1* model over-predicts the corresponding pre- (θ_p) and post-capping (θ_{pc})
692 plastic rotation capacities by at least 20%. Although the ATC/PEER 72-1 *Option 3* model over-
693 predicts the θ_p and θ_{pc} values by at least 50% for steel columns under reversed cyclic lateral loading,
694 much closer predictions are obtained for columns under collapse-consistent lateral loading.

695 Continuum finite element (CFE) models shall always consider geometric imperfections (GIs)
696 to properly trace local buckling of wide-flange steel columns with seismically compact cross-
697 sections near the high ductility limits as per ANSI/AISC 341-16 (AISC 2016a). In particular,
698 comparisons between the measured data and predictions from high-fidelity CFE column models
699 indicate that if GIs are neglected, then the predicted local buckling initiation as well as the
700 subsequent column damage progression is vastly different than that observed in reality. The
701 modeling recommendations by Elkady and Lignos (2018b) are deemed rational for simulating
702 cyclic plastic buckling of wide-flange steel columns.

703 The concept of a column repairability curve was also introduced. Based on the gathered
704 experimental data, these curves integrate in a single compact graphical format various column
705 performance indicators including the residual axial shortening, flange-tip in-plane deformation due
706 to local buckling and the column reserve capacity as a function of the story-drift demand. In
707 general, the column repairability curves presented herein indicate that when a column experiences
708 40mm flange-tip deformation ($\approx 7^\circ$ flange rotation angle) or 30mm residual axial shortening, its
709 reserve capacity is less than 80% of the attained peak flexural resistance. In that respect, the
710 interaction of a column with its concrete footing also affects the extent of column (Inamasu et al.
711 2017). This is outside the scope of the present study since the considered test specimens were
712 idealized with a fixed end boundary condition.

713 Finally, comparisons of the gathered experimental results with those from prior related studies
714 indicate that scale effects shall be carefully considered in order to properly trace the primary
715 column instability mode. The interaction between a wide-flange cross-section's flange and web
716 shall be considered to properly define section classification limits to control the axial shortening
717 and the cyclic deterioration in flexural strength of steel columns for seismic applications.

718 **Acknowledgements**

719 This study was based on work supported by the Natural Sciences and Engineering Research
720 Council of Canada (NSERC) under the Discovery Grant Program. The test specimen material and

721 fabrication was generously donated by ADF Corporation Inc. Additional support for the second
722 author was provided by the Swiss National Science Foundation (Award Number 200021_169248)
723 as well as École Polytechnique Fédérale de Lausanne (EPFL). The financial support is gratefully
724 acknowledged. The authors would like to sincerely thank Dr. William Cook, Mr. John Bartczak at
725 Jamieson Structural Laboratory at McGill University as well as Prof. Colin Rogers for their
726 invaluable assistance for the successful completion of the testing program. Any opinions, findings,
727 and conclusions or recommendations expressed in this paper are those of the authors and do not
728 necessarily reflect the views of sponsors.

729 **Notation**

730 The following symbols are used in this paper:

- 731 A = gross cross-section area;
732 A_w = web's cross-section area;
733 b_f = flange's width;
734 C_b = Lateral-torsional buckling modification factor ([AISC 2016b](#));
735 d = column cross-section's depth;
736 E = measured modulus of elasticity of steel;
737 $f_{u,w}, f_{u,f}$ = measured ultimate stress of steel in the columns web and flange, respectively;
738 $f_{y\ mill}$ = measured yield stress of steel based on mill certificate;
739 $f_{y,w}, f_{y,f}$ = measured yield stress of steel in the columns web and flange, respectively;
740 $f_{u\ mill}$ = measured ultimate stress of steel based on mill certificate;
741 f_{yn} = minimum specified (nominal) yield stress of steel ([ASTM 2015](#));
742 G = measured shear modulus of steel;
743 h = web's height;
744 I = column cross-section's moment-of-inertia about the strong-axis;
745 $K_{axial,el}$ = column's elastic axial stiffness;
746 K_{axial}^- = column's axial stiffness in the negative loading direction;
747 K_{axial}^+ = column's axial stiffness in the positive loading direction;
748 K_b = column's elastic flexural stiffness based on bending deformations;
749 K_e = column's elastic flexural stiffness;
750 K_s = column's elastic flexural stiffness based on shear deformations;

- 751 L = column's clear length, $L=1750\text{mm}$;
- 752 L_b = column's unbraced length, $L_b=1750\text{mm}$;
- 753 L_c = column's effective length for buckling about the weak-axis, $L_c=875\text{mm}$;
- 754 L_{PH} = column's measured plastic hinge length;
- 755 M = moment demand at the top surface of the column base;
- 756 M_c = available bending strength (AISC 2016b);
- 757 M_{max} = peak measured bending resistance;
- 758 M_p = full plastic bending strength based on measured geometric and material properties;
- 759 M_y^* = effective yield bending strength (PEER/ATC 2010);
- 760 P = applied load in the gravity direction;
- 761 P_c = available axial strength (AISC 2016b);
- 762 P_g = applied gravity load offset;
- 763 P_y = axial yield strength based on measured geometric and material properties;
- 764 r_y = radius of gyration about the cross-section's weak-axis;
- 765 R_y = ratio of the expected yield stress to the specified minimum yield stress (AISC 2016a);
- 766 t_f = flange's thickness;
- 767 t_w = web's thickness;
- 768 Z = column cross-section's plastic modulus about the strong-axis;
- 769 α = cross-section's shear coefficient (Cowper 1966);
- 770 β = bending-to-shear stiffness ratio;
- 771 Δ_{axial} = column's axial shortening in the gravity direction;
- 772 δ_f = in-plane flange tip displacement with respect to the undeformed position;
- 773 δ_{OP} = out-of-plane column displacement with respect to the undeformed position;
- 774 θ = column's chord-rotation over its clear length;
- 775 θ_p = column's pre-capping plastic rotation capacity;
- 776 θ_{pc} = column's post-capping plastic rotation capacity;
- 777 λ_{hd} = Limiting slenderness parameter for highly ductile compression elements (AISC 2016a);
- 778 ϕ = resistance factor (AISC 2016b).

779 **References**

- 780 ABAQUS-FEA/CAE. (2011). Dassault Systemes Simulia Corp., RI, USA. © Dassault Systèmes,
781 2010.

782 AISC (2016a). "Seismic provisions for structural steel buildings." *ANSI/AISC 341-16*, Chicago, IL

783 AISC (2016b). "Specification for structural steel buildings." *ANSI/AISC 360-16*, Chicago, IL

784 Akcelyan, S., and Lignos, D. G. (2018). "Seismic retrofit of steel tall buildings with bilinear oil
785 dampers." *Proc., 16th European Conf. on Earthquake Eng.*, Thessaloniki, Greece.

786 Araújo, M., Macedo, L., and Castro, J. M. (2017). "Evaluation of the rotation capacity limits of
787 steel members defined in EC8-3." *J. of Constructional Steel Research*, 135, 11-29. DOI:
788 [10.1016/j.jcsr.2017.04.004](https://doi.org/10.1016/j.jcsr.2017.04.004).

789 Alavi, B., and Krawinkler, H. (2004). "Behavior of moment- resisting frame structures subjected
790 to near- fault ground motions." *Earthquake Eng. & Structural Dynamics*, 33(6), 687-706.
791 DOI: [10.1002/eqe.369](https://doi.org/10.1002/eqe.369).

792 Armstrong, P. J., and Frederick, C. O. (1966). "A mathematical representation of the multiaxial
793 bauschinger effect." *Materials at High Temperatures*, 24(1), 1-26. DOI:
794 [10.1179/096034007X207589](https://doi.org/10.1179/096034007X207589).

795 ASCE (1971). "Plastic design in steel, a guide and commentary." *Manual of Practice No. 41*, New
796 York, USA.

797 ASCE (2014). "Seismic evaluation and retrofit of existing buildings." *ASCE/SEI 41-13*, Reston,
798 VA.

799 ASTM (2014). "Standard specification for general requirements for rolled structural steel bars,
800 plates, shapes, and sheet piling." *ASTM A6/A6M-14*, ASTM International, West
801 Conshohocken, PA, USA.

802 ASTM (2015). "Standard specification for structural steel shapes." *ASTM A992/A992M*, ASTM
803 International, West Conshohocken, PA, USA.

804 AWS (2009). "Structural welding code - seismic supplement." *AWS D1.8/D1.8M:2009*, Miami, FL,
805 USA.

806 Bech, D., Tremayne, B., and Houston, J. (2015). "Proposed changes to steel column evaluation
807 criteria for existing buildings." *Proc., 2nd ATC-SEI Conf. on Improving the Seismic
808 Performance of Existing Building and Other Structures*, San Francisco, CA, USA.

809 Bruneau, M., Uang, C.-M., and Sabelli, S. R. (2011). *Ductile design of steel structures*, McGraw
810 Hill Professional.

811 Chen, Y., Cheng, X., and Nethercot, D. A. (2013). "An overview study on cross-section
812 classification of steel H-sections." *J. of Constructional Steel Research*, 80, 386-393. DOI:
813 [10.1016/j.jcsr.2012.10.006](https://doi.org/10.1016/j.jcsr.2012.10.006).

814 Cheng, X., Chen, Y., and Nethercot, D. A. (2013a). "Experimental study on H-shaped steel beam-
815 columns with large width-thickness ratios under cyclic bending about weak-axis." *Eng.
816 Structures*, 49, 264-274. DOI: [10.1016/j.engstruct.2012.10.035](https://doi.org/10.1016/j.engstruct.2012.10.035).

817 Cheng, X., Chen, Y., and Pan, L. (2013b). "Experimental study on steel beam-bolumns composed
818 of slender H-sections under cyclic bending." *J. of Constructional Steel Research*, 88, 279-
819 288. DOI: [10.1016/j.jcsr.2013.05.020](https://doi.org/10.1016/j.jcsr.2013.05.020).

820 Clark, P., Frank, K., Krawinkler, H., and Shaw, R. (1997). "Protocol for fabrication, inspection,
821 testing, and documentation of beam-column connection tests and other experimental
822 specimens". *Report no. SAC/BD-97*. SAC Joint Venture, Sacramento, CA.

823 Clifton, C., Bruneau, M., MacRae, G., Leon, R., and Fussell, A. (2011). "Steel structures damage
824 from the Christchurch earthquake series of 2010 and 2011." *Bulletin of the New Zealand
825 Society for Earthquake Eng.*, 44(4), 297-318.

826 Cowper, G. R. (1966). "The shear coefficient in timoshenko's beam theory." *Journal of Applied
827 Mechanics*, 33(2), 335-340, DOI: [10.1115/1.3625046](https://doi.org/10.1115/1.3625046)

828 Do, T. N., and Filippou, F. C. (2018). "A damage model for structures with degrading response."
829 *Earthquake Eng. & Structural Dynamics*, 47(2), 311-332. DOI: [10.1002/eqe.2952](https://doi.org/10.1002/eqe.2952).

830 Elkady, A., Ghimire, S., and Lignos, D. G. (2018). "Fragility curves for wide-flange steel columns
831 and implications on building-specific earthquake-induced loss assessment." *Earthquake*
832 *Spectra*. DOI: [10.1193/122017EQS260M](https://doi.org/10.1193/122017EQS260M).

833 Elkady, A., and Lignos, D. G. (2014). "Modeling of the composite action in fully restrained beam-
834 to-column connections: I y of steel implications in the seismic design and collapse capacit
835 *E "*.special moment frames*earthquake Eng. & Structural Dynamics*, 43(13), 1935-1954.
836 DOI: [10.1002/eqe.2430](https://doi.org/10.1002/eqe.2430).

837 Elkady, A., and Lignos, D. G. (2015a). "Analytical investigation of the cyclic behavior and plastic
838 hinge formation in deep wide-flange steel beam-columns." *Bulletin Earthquake Eng*, 13(4),
839 1097-1118. DOI: [10.1007/s10518-014-9640-y](https://doi.org/10.1007/s10518-014-9640-y).

840 Elkady, A., and Lignos, D. G. (2015b). "Effect of gravity framing on the overstrength and collapse
841 capacity of steel frame buildings with perimeter special moment frames." *Earthquake Eng.*
842 *& Structural Dynamics*, 44(8), 1289–1307. DOI: [10.1002/eqe.2519](https://doi.org/10.1002/eqe.2519).

843 Elkady, A., and Lignos, D. G. (2016). "Dynamic stability of deep and slender wide-flange steel
844 columns-full scale experiments." *Proc. of the Annual Stability Conf.*, Orlando, Florida.

845 Elkady, A., and Lignos, D. G. (2018a). "Full-scale testing of deep wide-flange steel columns under
846 multi-axis cyclic loading: Loading sequence, boundary effects and out-of-plane brace force
847 demands." *ASCE J. of Structural Eng.*, 144(2). DOI: [10.1061/\(ASCE\)ST.1943-
848 541X.0001937](https://doi.org/10.1061/(ASCE)ST.1943-541X.0001937).

849 Elkady, A., and Lignos, D. G. (2018b). "Improved seismic design and nonlinear modeling
850 recommendations for wide-flange steel columns." *ASCE J. of Structural Eng.*, 144(9).
851 DOI: [10.1061/\(ASCE\)ST.1943-541X.0002166](https://doi.org/10.1061/(ASCE)ST.1943-541X.0002166).

852 FEMA (2000). "State of the art report on connection performance." *Report FEMA-355D*, Federal
853 Emergency Management Agency, Washington, DC.

854 FEMA (2009a). "Fragility curves for components of steel SMF systems." *Background Document*
855 *FEMA P-58/BD-3.8.3*, Federal Emergency Management Agency, Washington, DC.

856 FEMA (2009b). "Quantification of building seismic performance factors." *Report FEMA-P695*,
857 Federal Emergency Management Agency, Washington, DC.

858 Fogarty, J., and El-Tawil, S. (2015). "Collapse resistance of steel columns under combined axial
859 and lateral loading." *J. of Structural Eng.*, 142(1). DOI: [10.1061/\(ASCE\)ST.1943-
860 541X.0001350](https://doi.org/10.1061/(ASCE)ST.1943-541X.0001350).

861 Gupta, A., and Krawinkler, H. (2000). "Behavior of ductile SMRFs at various seismic hazard
862 levels." *J. of Structural Eng.*, 126(1), 98-107. DOI: [10.1061/\(ASCE\)0733-
863 9445\(2000\)126:1\(98\)](https://doi.org/10.1061/(ASCE)0733-9445(2000)126:1(98)).

864 Hamburger, R., Deierlein, G. G., Lehman, D. E., Lignos, D. G., Lowes, L. N., Pekelnicky, R.,
865 Shing, P. B., Somers, P., and van de Lindt, J. W. (2018). "Recommended modeling
866 parameters and acceptance criteria for nonlinear analysis in support of seismic evaluation,
867 retrofit, and design." *NIST GCR 17-917-45*, Prepared for the U.S. Department of
868 Commerce and the National Institute of Standards and Technology (NIST) by the Applied
869 Technology Council (ATC).

870 Haselton, C. B., Liel, A. B., Lange, S. T., and Deierlein, G. G. (2008). "Beam-column element
871 model calibrated for predicting flexural response leading to global collapse of RC frame
872 buildings." *Report No. 2007/03*, Pacific Earthquake Eng. Research Center, Berkeley, CA,
873 USA.

874 Ibarra, L., and Krawinkler, H. (2005). "Global collapse of frame structures under seismic
875 excitations." *Report No. 152*, The John A. Blume Earthquake Eng. Center, Stanford
876 University, California, USA.

877 Ibarra, L. F., Medina, R. A., and Krawinkler, H. (2005). "Hysteretic models that incorporate
878 strength and stiffness deterioration." *Earthquake Eng. & Structural Dynamics*, 34(12),
879 1489-1511. DOI: [10.1002/eqe.495](https://doi.org/10.1002/eqe.495).

880 Inamasu, H., Lignos, D. G., and Kanvinde, A. (2017). "Effect of column base flexibility on the
881 hysteretic response of wide-flange steel columns." *Proc., 3rd Huixian Int. Forum on*
882 *Earthquake Eng. for Young Researchers*, Urbana-Champaign, Illinois, USA.

883 Kanno, R. (2016). "Advances in steel materials for innovative and elegant steel structures in Japan-
884 a review." *Structural Eng. Int.*, 26(3), 242-253. DOI:
885 [10.2749/101686616X14555428759361](https://doi.org/10.2749/101686616X14555428759361).

886 Kolwankar, S., Kanvinde, A., Kenawy, M., Lignos, D. G., and Kunnath, S. K. (2018). "Simulating
887 local buckling-induced softening in steel members using an equivalent nonlocal material
888 model in displacement-based fiber elements." *J. of Structural Eng.*, 144(10), 04018192.
889 DOI: [10.1061/\(ASCE\)ST.1943-541X.0002189](https://doi.org/10.1061/(ASCE)ST.1943-541X.0002189).

890 Krawinkler, H. (2009). "Loading histories for cyclic tests in support of performance assessment of
891 structural components." *Proc., 3rd Int. Conf. on Advances in Experimental Structural Eng.*,
892 San Francisco, CA, USA, 15-16.

893 Krawinkler, H., Zohrei, M., Lashkari-Irvani, B., Cofie, N. G., and Hadidi-Tamjed, H. (1983).
894 "Recommendations for experimental studies on the seismic behavior of steel components
895 and materials." *Report No. 61*, The John A. Blume Earthquake Eng. Center, Stanford
896 University, California, USA.

897 LATBSDC (2017). "An alternative procedure for the analysis and design of tall buildings located
898 in the los angeles region." Los Angeles, CA, USA.

899 Lemaitre, J., and Chaboche, J. (1975). "A non-linear model of creep-fatigue damage cumulation
900 and interaction (for hot metallic structures)." *Mechanics of visco-elastic media and bodies*.

901 Lignos, D., Krawinkler, H., and Whittaker, A. (2011a). "Prediction and validation of sidesway
902 collapse of two scale models of a 4-story steel moment frame." *Earthquake Eng. &*
903 *Structural Dynamics*, 40(7), 807-825, DOI: [10.1002/eqe.1061](https://doi.org/10.1002/eqe.1061).

904 Lignos, D. G., Chung, Y., Nagae, T., and Nakashima, M. (2011b). "Numerical and experimental
905 evaluation of seismic capacity of high-rise steel buildings subjected to long duration
906 earthquakes." *Computers & Structures*, 89(11), 959-967, DOI:
907 [10.1016/j.compstruc.2011.01.017](https://doi.org/10.1016/j.compstruc.2011.01.017).

908 Lignos, D. G., Hartloper, A., Elkady, A., Hamburger, R., and Deierlein, G. G. (2019). "Proposed
909 updates to the ASCE 41 nonlinear modeling parameters for wide-flange steel columns in
910 support of performance-based seismic engineering." *J. of Structural Eng.* (accepted).

911 Lignos, D. G., Hikino, T., Matsuoka, Y., and Nakashima, M. (2013). "Collapse assessment of steel
912 moment frames based on E-Defense full-scale shake table collapse tests." *J. of Structural*
913 *Eng.*, 139(1), 120-132. DOI: [10.1061/\(ASCE\)ST.1943-541X.0000608](https://doi.org/10.1061/(ASCE)ST.1943-541X.0000608).

914 Lignos, D. G., and Krawinkler, H. (2011). "Deterioration modeling of steel components in support
915 of collapse prediction of steel moment frames under earthquake loading." *J. of Structural*
916 *Eng.*, 137(11), 1291-1302. DOI: [10.1061/\(ASCE\)ST.1943-541X.0000376](https://doi.org/10.1061/(ASCE)ST.1943-541X.0000376).

917 Lignos, D. G., and Krawinkler, H. (2013). "Development and utilization of structural component
918 databases for performance-based earthquake engineering." *J. of Structural Eng.*, 139(8),
919 1382-1394. DOI: [10.1061/\(ASCE\)ST.1943-541X.0000646](https://doi.org/10.1061/(ASCE)ST.1943-541X.0000646).

920 MacRae, G. A., Carr, A. J., and Walpole, W. R. (1990). "The seismic response of steel frames." *Report No. 90-6*, Department of Civil Eng., University of Canterbury, New Zealand.

921

922 MacRae, G. A., Urmson, C. R., Walpole, W. R., Moss, P., Hyde, K., and Clifton, C. (2009). "Axial shortening of steel columns in buildings subjected to earthquakes." *Bulletin of the New Zealand Society for Earthquake Eng.*, 42(4), 275.

923

924

925 Maison, B. F., and Speicher, M. S. (2016). "Loading Protocols for ASCE 41 Backbone Curves." *Earthquake Spectra*, 32(4), 2513-2532. DOI: [10.1193/010816EQS007EP](https://doi.org/10.1193/010816EQS007EP).

926

927 Miyamura, T., Yamashita, T., Akiba, H., and Ohsaki, M. (2015). "Dynamic FE simulation of four-story steel frame modeled by solid elements and its validation using results of full-scale shake-table test." *Earthquake Eng. & Structural Dynamics*, 44(9), 1449-1469. DOI: [10.1002/eqe.2526](https://doi.org/10.1002/eqe.2526).

928

929

930

931 Nakashima, M., Nagae, T., Enokida, R., and Kajiwara, K. (2018). "Experiences, accomplishments, lessons, and challenges of E-Defense tests using world's largest shaking table." *Japan Architectural Review*, 1(1), 4-17. DOI: [10.1002/2475-8876.10020](https://doi.org/10.1002/2475-8876.10020).

932

933

934 Nakashima, M., Takanashi, K., and Kato, H. (1990). "Test of steel beam-columns subject to sidesway." *J. of Structural Eng.*, 116(9), 2516-2531. DOI: [10.1061/\(ASCE\)0733-9445\(1990\)116:9\(2516\)](https://doi.org/10.1061/(ASCE)0733-9445(1990)116:9(2516)).

935

936

937 Newell, J. D., and Uang, C.-M. (2006). "Cyclic behavior of steel columns with combined high axial load and drift demand." *Report No. SSRP-06/22*, Department of Structural Eng., University of California, San Diego.

938

939

940 NIST (2010a). "Evaluation of the FEMA P695 methodology for quantification of building seismic performance factors." *NIST GCR 10-917-8*, NEHRP consultants Joint Venture.

941

942 NIST (2010b). "Research plan for the study of seismic behaviour and design of deep slender wide flange structural steel beam-column members." *NIST GCR 11-917-13*, NEHRP consultants Joint Venture.

943

944

945 Okazaki, T., Lignos, D. G., Midorikawa, M., Ricles, J. M., and Love, J. (2013). "Damage to steel buildings observed after the 2011 Tohoku-Oki earthquake." *Earthquake Spectra*, 29(S1), S219-S243. DOI: [10.1193/1.4000124](https://doi.org/10.1193/1.4000124).

946

947

948 Ozkula, G., Harris, J., and Uang, C. M. (2017). "Observations from cyclic tests on deep, wide-flange beam-columns." *AISC Eng. J.*, 54(1), 45-61.

949

950 PEER (2017). "Guidelines for performance-based seismic design of tall buildings." *Report No. 2017/06*, Pacific Earthquake Eng. Center, Berkeley, California, USA.

951

952 PEER/ATC (2010). "Modeling and acceptance criteria for seismic design and analysis of tall buildings." *PEER/ATC 72-1*, Redwood City, CA.

953

954 Peng, B. H., MacRae, G. A., Walpole, W. R., Moss, P., Dhakal, R., and Clifton, C. (2008). "Plastic hinge location in columns of steel frames subjected to seismic actions." *Bulletin of the New Zealand Society for Earthquake Eng.*, 41(1).

955

956

957 Pericoli, V., and Kanvinde, A. (2018). "Theoretical study of ductile fracture in steel structures in the presence of spatial variability in toughness." *J. of Structural Eng.*, 144(5), 04018024, DOI: [10.1061/\(ASCE\)ST.1943-541X.0002008](https://doi.org/10.1061/(ASCE)ST.1943-541X.0002008).

958

959

960 Popov, E. P., Bertero, V. V., and Chandramouli, S. (1975). "Hysteretic behavior of steel columns." *Report No. EERC 75-11*, Earthquake Engineering Research Center, Berkeley, CA, USA.

961

962 Shirasawa, H., Kobayashi, H., and Jizaimaru, J. (1981). "The effect of various strengthening methods on ductility of high strength steel sheets." *Tetsu-to-Hagane (J. of the Iron and Steel Institute of Japan)*, 67(14), 2208-2215.

963

964

965 SNZ (2007). "Steel structures standard." *NZS 3404:2007*, Wellington, New Zealand.

- 966 Sousa, A. A., and Lignos, D. G. (2018). "On the inverse problem of classic nonlinear plasticity
967 models." *EPFL-REPORT-231968*, Ecole Polytechnique Federale de Lausanne (EPFL),
968 Lausanne, Switzerland.
- 969 Stoakes, C. D., and Fahnestock, L. A. (2016). "Strong-axis stability of wide flange steel columns
970 in the presence of weak-axis flexure." *J. of Structural Eng.*, 142(5), DOI:
971 [10.1061/\(ASCE\)ST.1943-541X.0001448](https://doi.org/10.1061/(ASCE)ST.1943-541X.0001448).
- 972 Suzuki, Y., and Lignos, D. G. (2014). "Development of loading protocols for experimental testing
973 of steel columns subjected to combined high axial load and lateral drift demands near
974 collapse." *Proc. of the 10th National Conf. on Earthquake Eng.*, Anchorage, Alaska, USA.
- 975 Suzuki, Y., and Lignos, D. G. (2015a). "Large scale collapse experiments of wide-flange steel
976 beam-columns." *Proc. of the 8th Int. Conf. on Behavior of Steel Structures in Seismic Areas*,
977 Shanghai, China.
- 978 Suzuki, Y., and Lignos, D. G. (2017). "Collapse behavior of steel columns as part of steel frame
979 buildings: Experiments and numerical models." *Proc., 16th World Conf. on Earthquake*
980 *Eng.*, Santiago, Chile.
- 981 Tirca, L., Chen, L., and Tremblay, R. (2015). "Assessing collapse safety of cbf buildings subjected
982 to crustal and subduction earthquakes." *J. of Constructional Steel Research*, 115, 47-61.
983 DOI: [10.1016/j.jcsr.2015.07.025](https://doi.org/10.1016/j.jcsr.2015.07.025).
- 984 Toutant, G., Minouei, Y. B., Imanpour, A., Koboevic, S., and Tremblay, R. (2017). "Stability of
985 steel columns in steel concentrically braced frames subjected to seismic loading." *Proc.,*
986 *ASCE Structures Congress*, Denver, Colorado, USA.
- 987 Uang, C.-M., and Bruneau, M. (2018). "State-of-the-art review on seismic design of steel
988 structures." *J. of Structural Eng.*, 144(4), 03118002. DOI: [10.1061/\(ASCE\)ST.1943-541X.0001973](https://doi.org/10.1061/(ASCE)ST.1943-541X.0001973).
- 989
- 990 Voce, E. (1948). "The relationship between stress and strain for homogeneous deformation." *J.*
991 *of the Institute of Metals*, 74, 537-562.
- 992 Wu, T.-Y., El-Tawil, S., and McCormick, J. (2018a). "Seismic collapse response of steel moment
993 frames with deep columns." *J. of Structural Eng.*, 144(9), 04018145. DOI:
994 [10.1061/\(ASCE\)ST.1943-541X.0002150](https://doi.org/10.1061/(ASCE)ST.1943-541X.0002150).
- 995 Wu, T.-Y., El-Tawil, S., and McCormick, J. (2018b). "Highly ductile limits for deep steel
996 columns." *J. of Structural Eng.*, 144(4), 04018016. DOI: [10.1061/\(ASCE\)ST.1943-541X.0002002](https://doi.org/10.1061/(ASCE)ST.1943-541X.0002002).
- 997
- 998 Zargar, S., Medina, R. A., and Miranda, E. (2014). "Cyclic behavior of deep steel columns
999 subjected to large drifts, rotations, and axial loads." *Proc., 10th National Conf. on*
1000 *Earthquake Eng.*, Anchorage, AK, USA.
- 1001 Zeimian, R. D., Abreu, J. C. B., Denavit, M. D., and Denavit, T.-J. L. (2018). "Three-Dimensional
1002 Benchmark Problems for Design by Advanced Analysis: Impact of Twist." *J. of Structural*
1003 *Eng.* 144(12), 04018220. DOI: [10.1061/\(ASCE\)ST.1943-541X.0002224](https://doi.org/10.1061/(ASCE)ST.1943-541X.0002224).

1004 **Table 1.** Test matrix summary and measured geometric and material properties.

| Spec. ID | Cross-Section | Lateral protocol | $\frac{P}{P_y}$ | $\frac{b_f}{2t_f}$ | $\frac{h}{t_w}$ | $\frac{L_b}{r_y}$ | Measured material properties [MPa] | | | | | | |
|----------|---------------|---------------------|-----------------|--------------------|-----------------|-------------------|------------------------------------|---------------|---------------|------------|------------|------------|------------|
| | | | | | | | E | $f_{y, mill}$ | $f_{u, mill}$ | $f_{y, w}$ | $f_{y, f}$ | $f_{u, w}$ | $f_{u, f}$ |
| A1 | W14x61 | Monotonic | 30% | | | | | | | | | | |
| A2 | W14x61 | Monotonic | 50% | | | | | | | | | | |
| A3 | W14x61 | Collapse-consistent | 50% | 7.8 | 30.4 | 29.3 | 202315 | 384 | 493 | 374 | 358 | 471 | 478 |
| A4 | W14x61 | Symmetric | 30%±45% | | | | | | | | | | |
| B1 | W16x89 | Monotonic | 30% | | | | | | | | | | |
| B2 | W16x89 | Monotonic | 50% | | | | | | | | | | |
| B3 | W16x89 | Symmetric | 50% | 5.9 | 25.9 | 28.9 | 199402 | 379 | 514 | 383 | 368 | 491 | 497 |
| B4 | W16x89 | Symmetric | 50%±25% | | | | | | | | | | |
| C1 | W14x82 | Monotonic | 30% | | | | | | | | | | |
| C2 | W14x82 | Monotonic | 50% | | | | | | | | | | |
| C3 | W14x82 | Symmetric | 50% | 5.9 | 22.4 | 29.0 | 199873 | 379 | 539 | 411 | 383 | 531 | 537 |
| C4 | W14x82 | Symmetric | 75% | | | | | | | | | | |

1005

1006 **Table 2.** Chemical composition of the steel material for Groups A, B and C [% mass].

| Group | C | Mn | P | S | Si | Cu | NI | Cr | Mo | V | Cb | Sn |
|-------|-------|-------|-------|-------|-------|-------|-------|-------|-------|-------|-------|-------|
| A | 0.070 | 0.990 | 0.013 | 0.032 | 0.200 | 0.320 | 0.150 | 0.140 | 0.032 | 0.004 | 0.004 | 0.013 |
| B | 0.090 | 1.210 | 0.020 | 0.035 | 0.290 | 0.340 | 0.110 | 0.110 | 0.030 | 0.000 | 0.022 | 0.350 |
| C | 0.090 | 1.390 | 0.021 | 0.028 | 0.290 | 0.260 | 0.100 | 0.150 | 0.030 | 0.010 | 0.026 | 0.010 |

1007

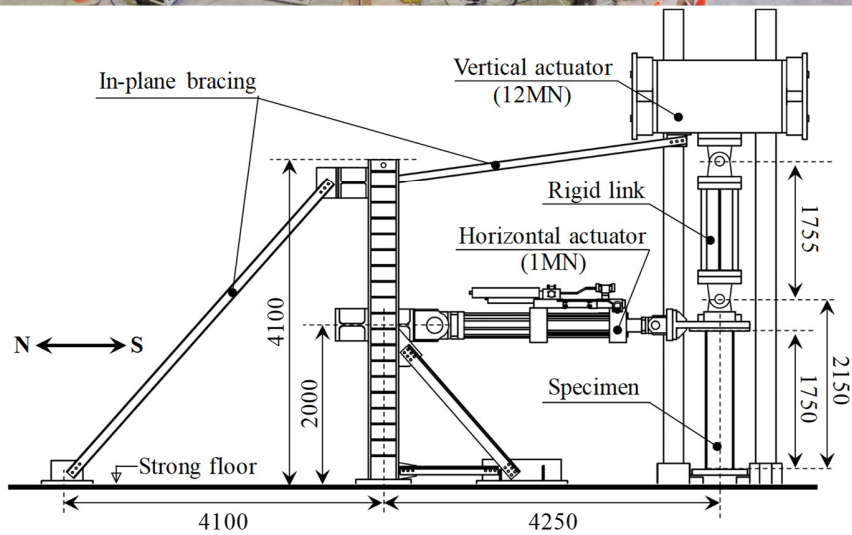
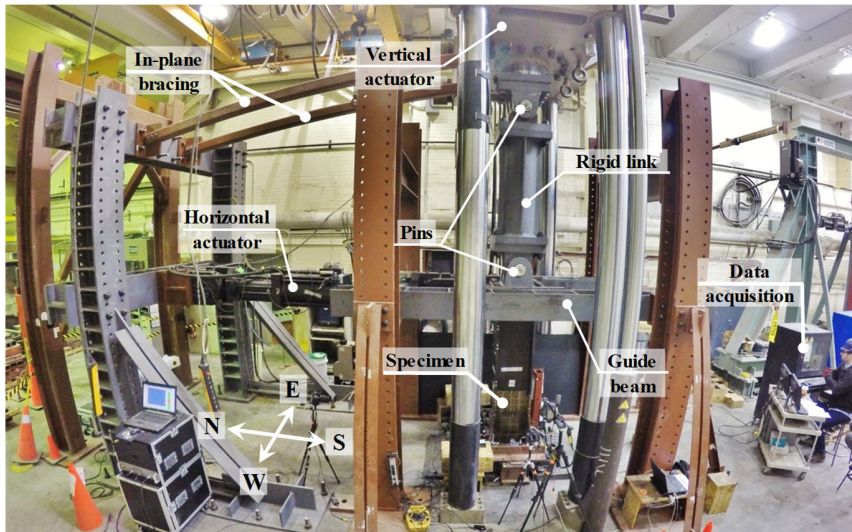

1035 **Fig. 1.** Overview of the test setup for experimental testing of cantilever steel column specimens
 1036 [Dimensions in mm].

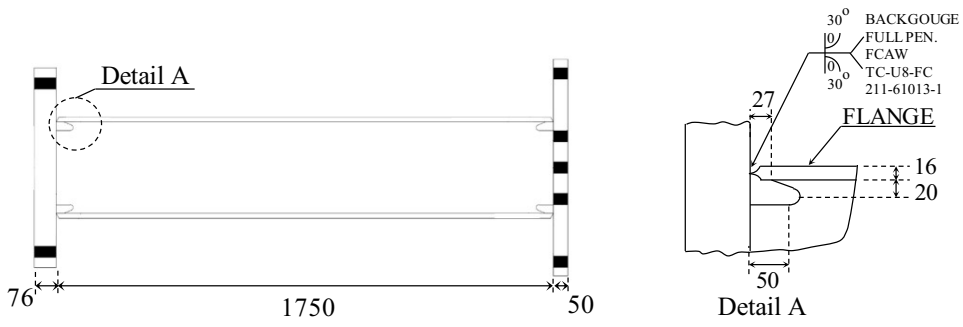

1037 **Fig. 2.** Typical column specimen detail (Group A) [Dimensions in mm].

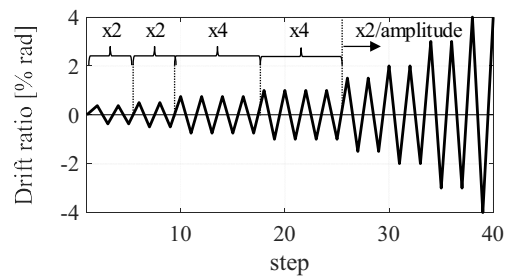

(a) Symmetric cyclic lateral loading protocol

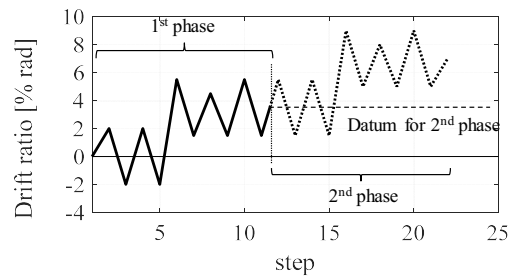

(b) Collapse-consistent lateral loading protocol

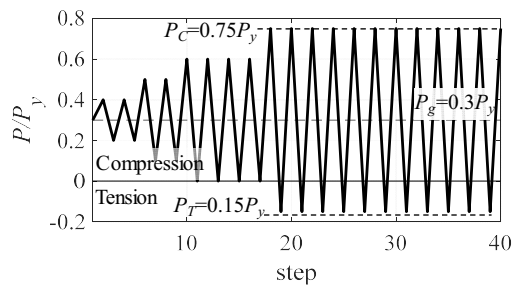

(c) Varying axial loading protocol
 $P_g/P_y=30\% \pm P_v/P_y=45\%$

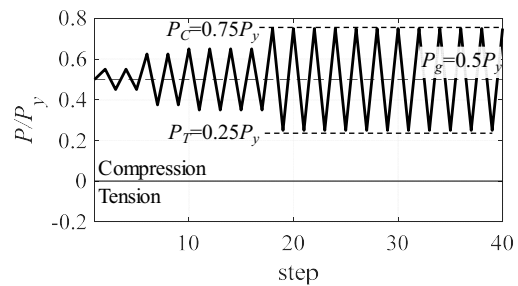

(d) Varying axial loading protocol
 $P_g/P_y=50\% \pm P_v/P_y=25\%$

1038 **Fig. 3.** Employed loading protocols for experimental testing of steel columns.

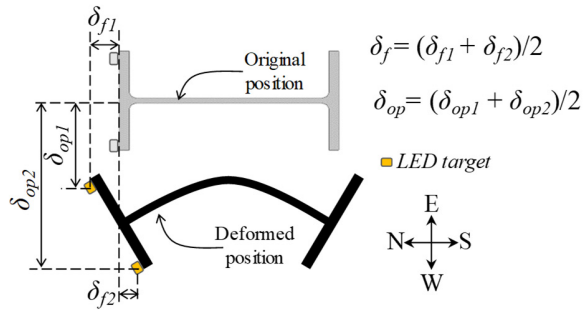
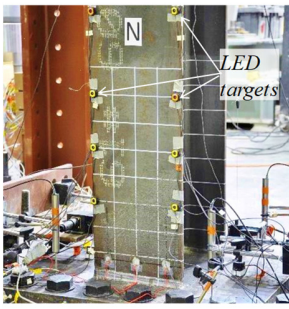

1039 **Fig. 4.** Illustration of deduced out-of-plane column deformation and in-plane flange deformation based on
 1040 LED measurements.

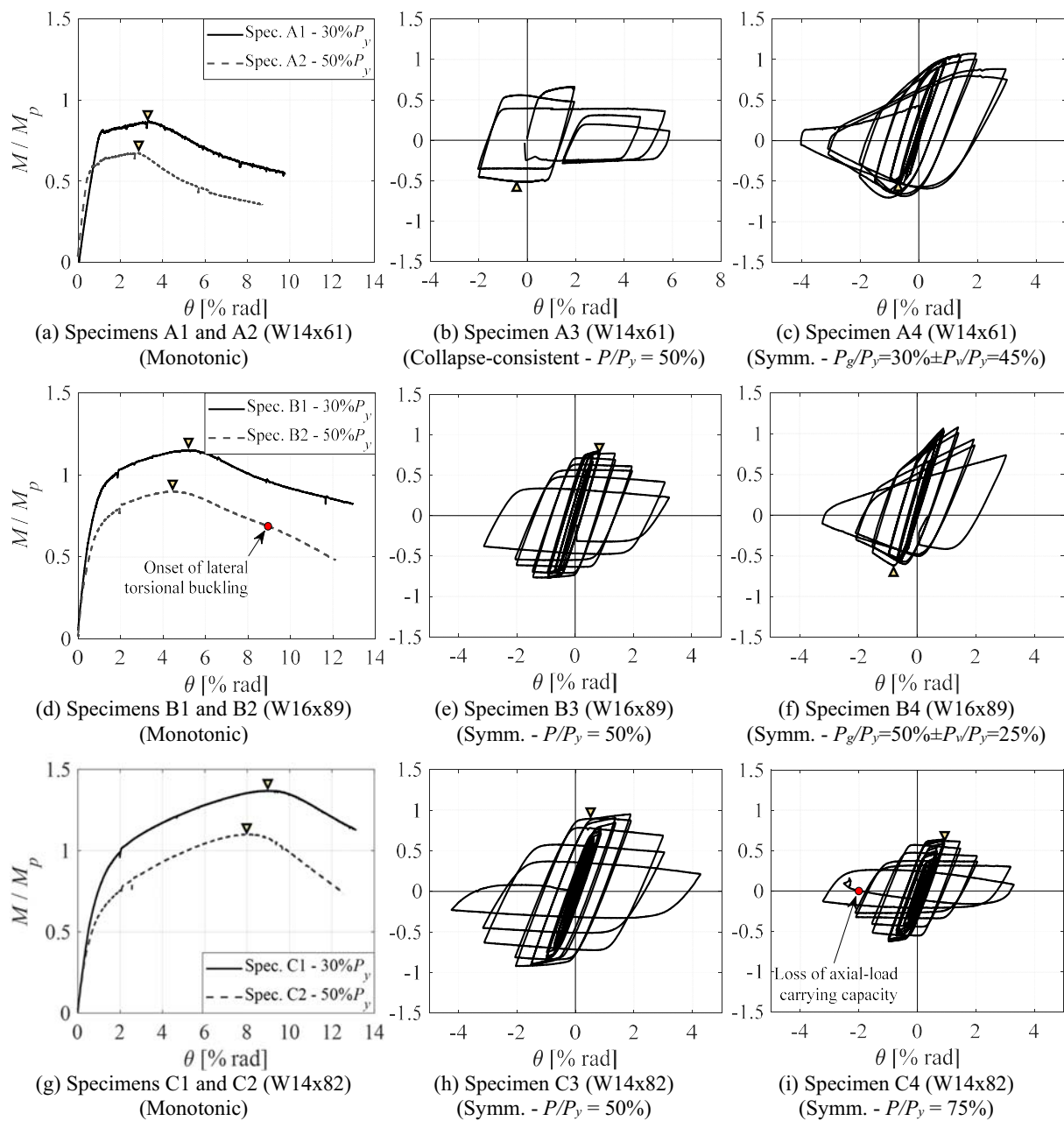

1041 **Fig. 5.** End moment versus chord-rotation relation of tested specimens [triangular markers indicate onset
1042 of local buckling].

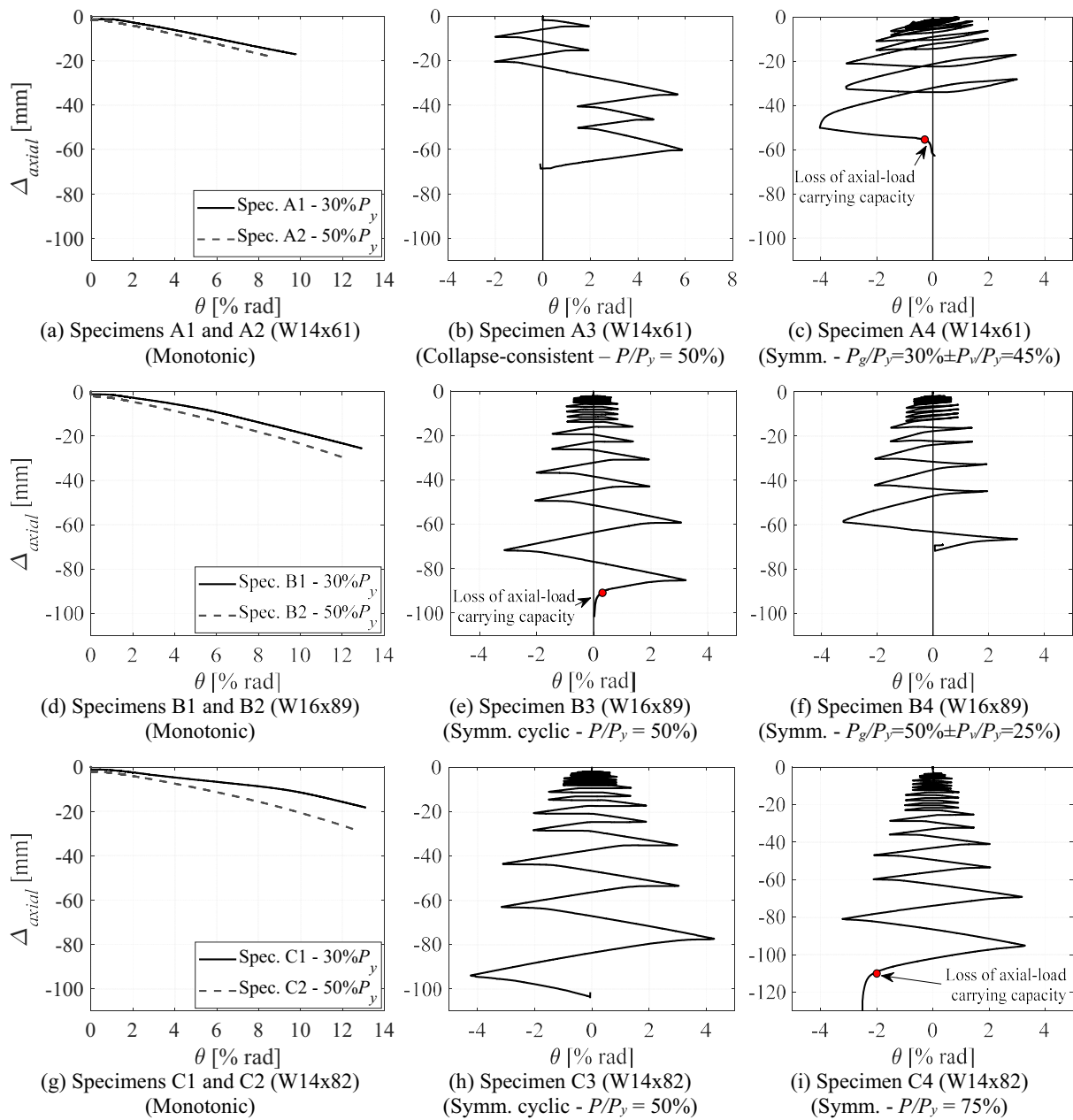

1042 **Fig. 6.** Column axial shortening versus chord-rotation relation of tested specimens.

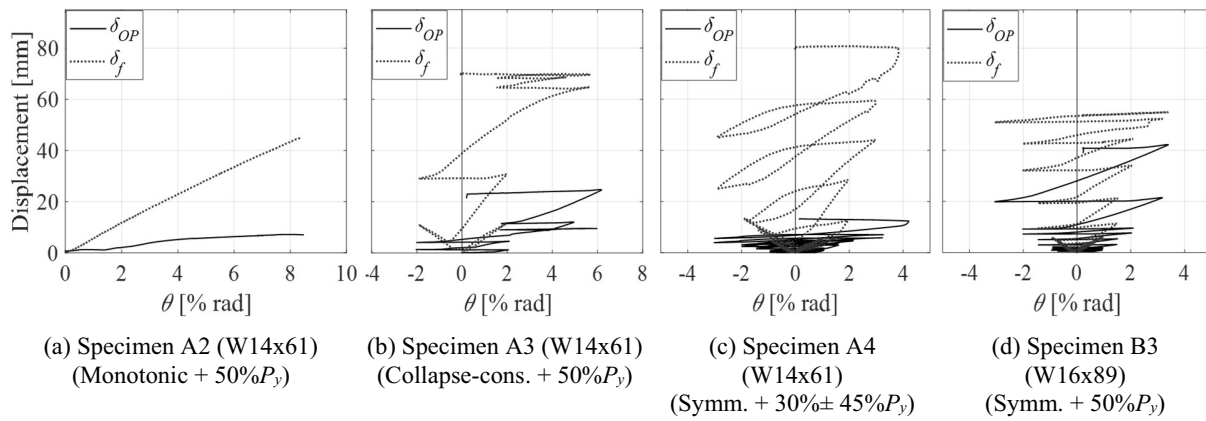

1043 **Fig. 7.** Out-of-plane and flange tip displacements versus chord-rotation of selected specimens.

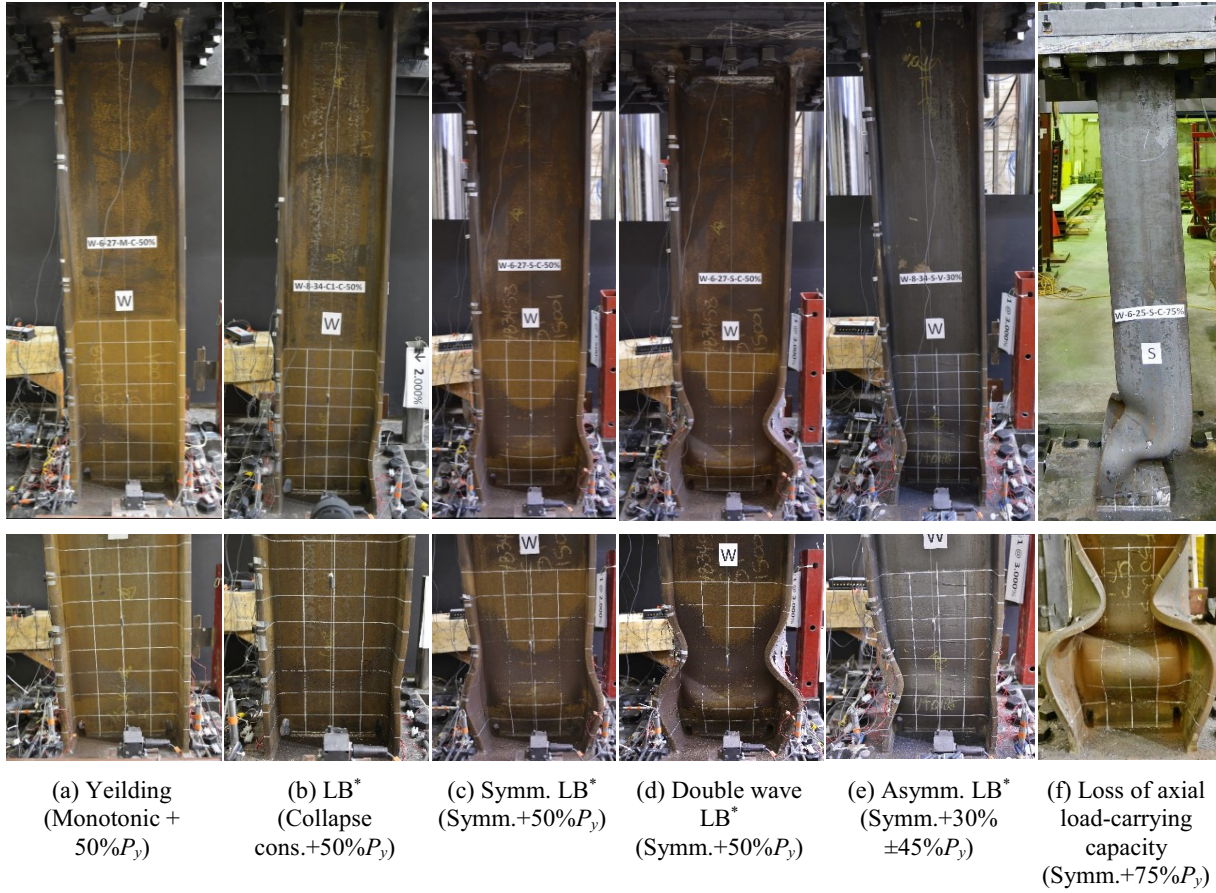

1044 **Fig. 8.** Typical damage progression and geometric instability modes [*LB: Local buckling].

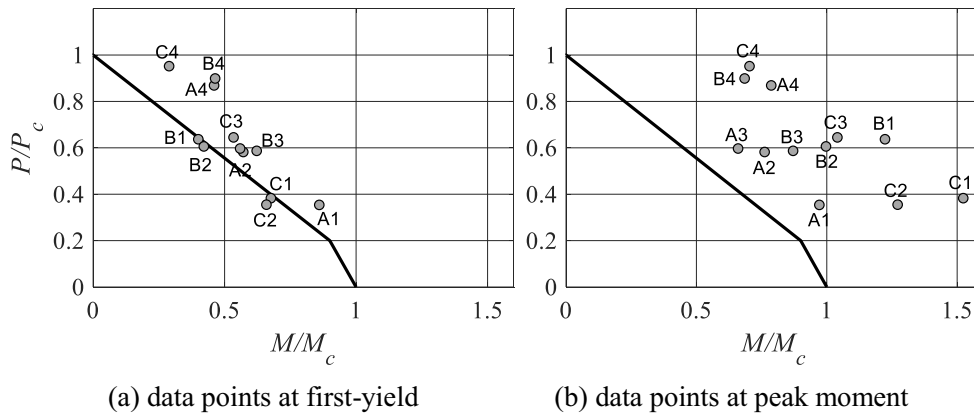

1045 **Fig. 9.** Evaluation of ANSI/AISC 360-16 axial force-bending (P-M) interaction curve.

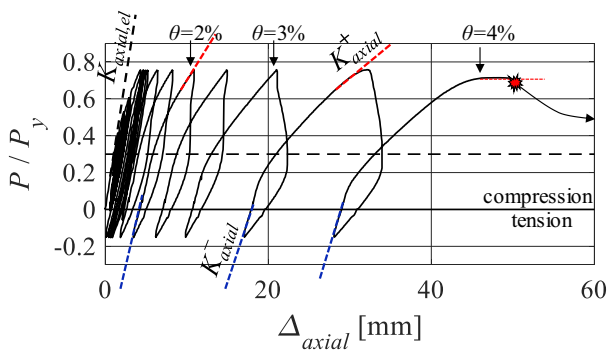

(a) Specimen A4

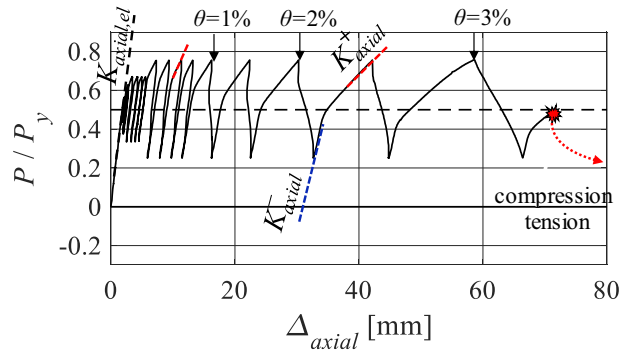

(b) Specimen B4

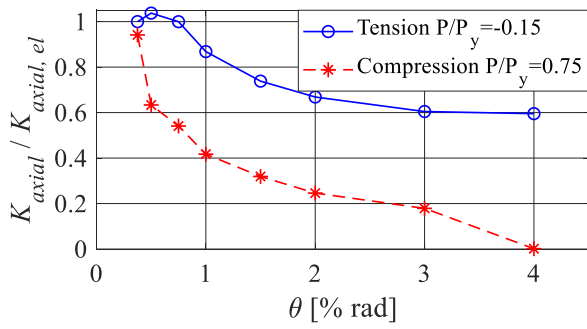

(c) Specimen A4

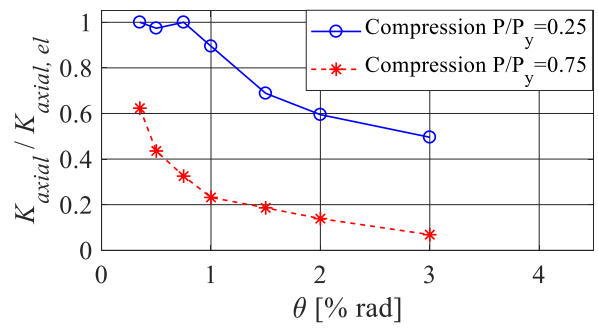

(d) Specimen B4

1046 **Fig. 10.** Variable axial load demands and corresponding column axial stiffness deterioration.

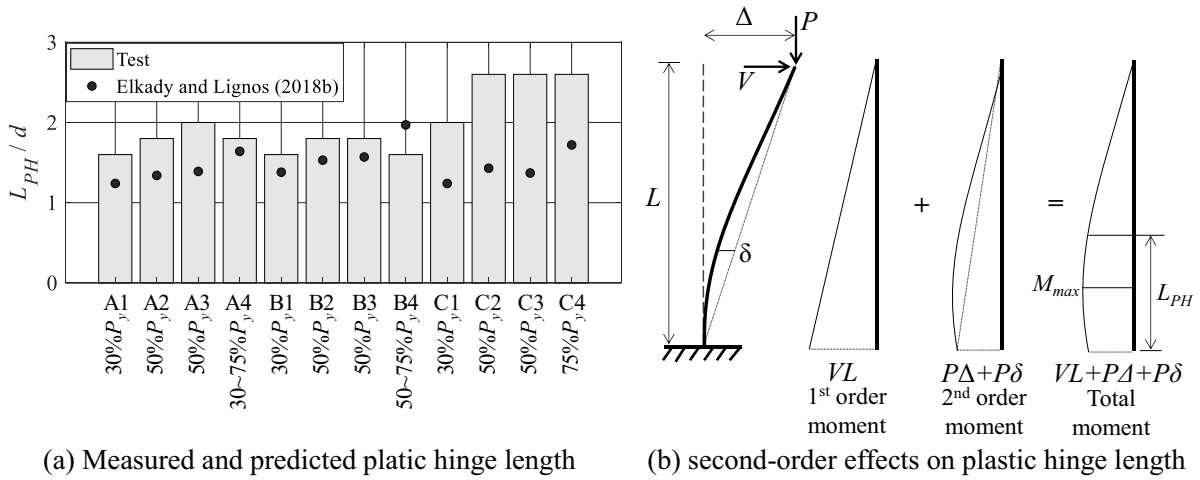

1047 Fig. 11. Assessment of column plastic hinge length.

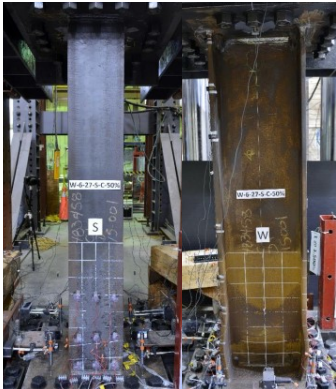

(a) Deformation profile at 2% drift
W16x89 (1.8m cantilever)

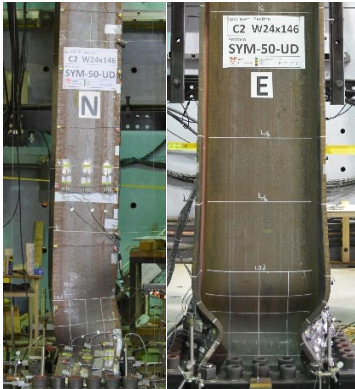

(b) Deformation profile at 2% drift
W24x146 (4m fixed-end)

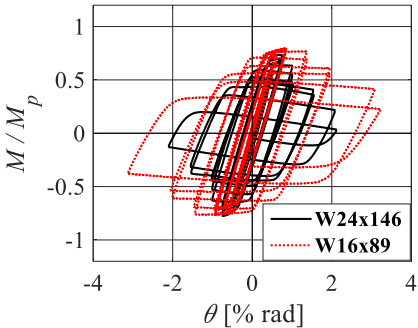

(c) Moment-rotation behavior at column base

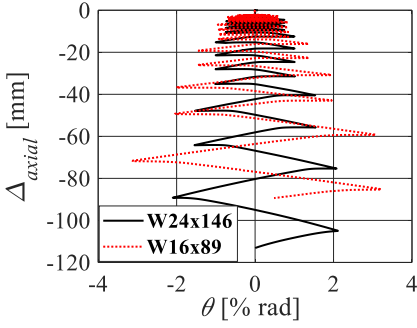

(d) Axial shortening-rotation behavior

1048 **Fig. 12.** Comparison of column specimens with different cross-section depths and end boundary
1049 conditions.

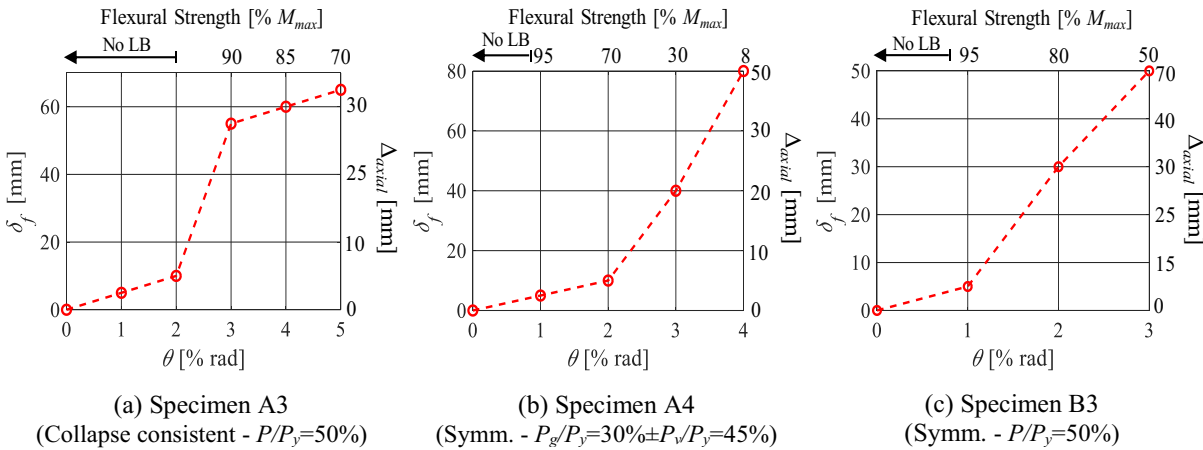

1050 **Fig. 13.** Typical column repairability curves.

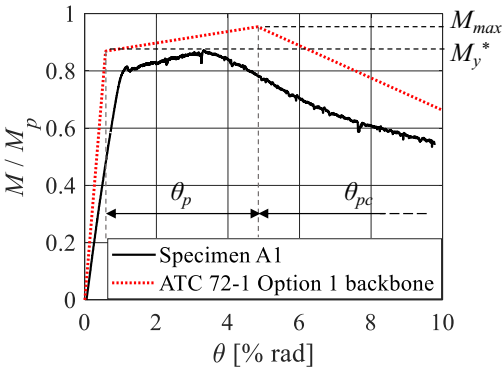

(a) Specimen A1

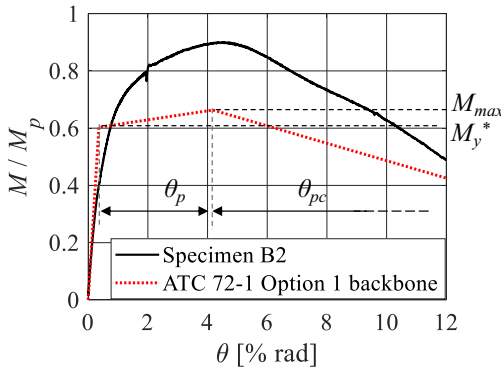

(b) Specimen B2

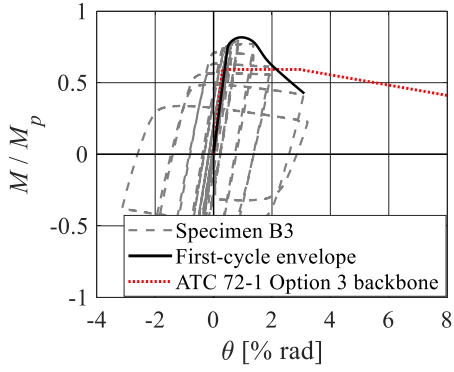

(c) Specimen B3

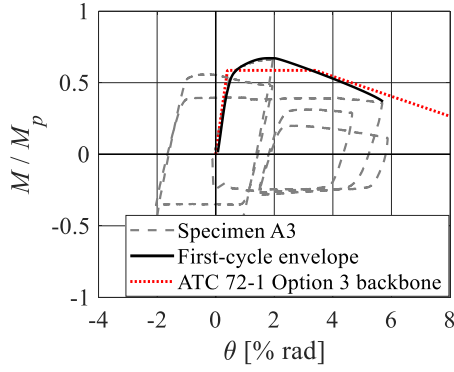

(d) Specimen A3

1051 **Fig. 14.** Assessment of PEER/ATC 72-1 modeling guidelines for monotonic and first-cycle envelope
1052 curves of wide-flange steel columns.

1053

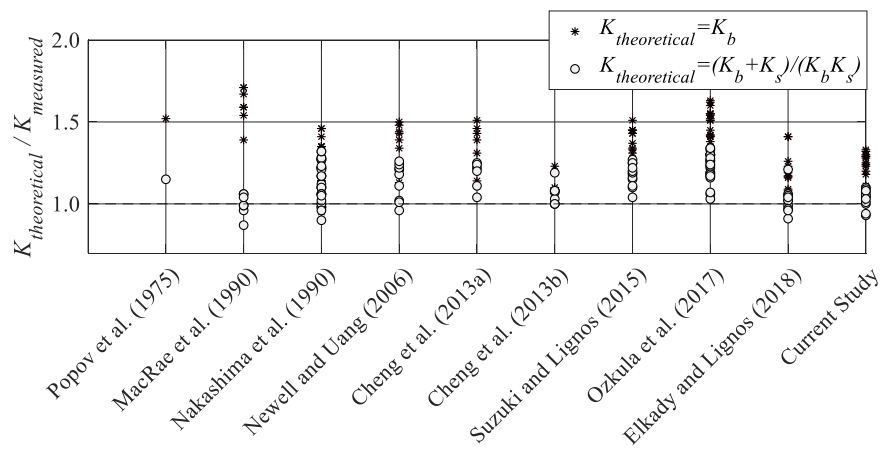
1054 **Fig. 15.** Ratio of theoretical-to-measured rotational stiffness for several past experimental programs.

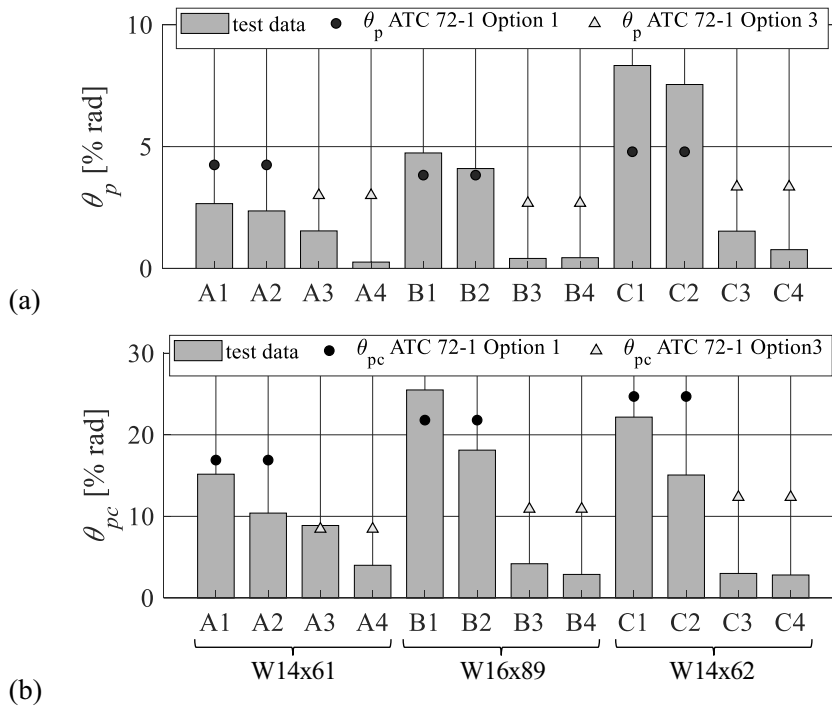

1055 **Fig. 16.** Assessment of predicted (a) pre- and (b) post-capping plastic rotations of wide-flange steel
 1056 columns based on PEER/ATC 72-1 modeling recommendations.

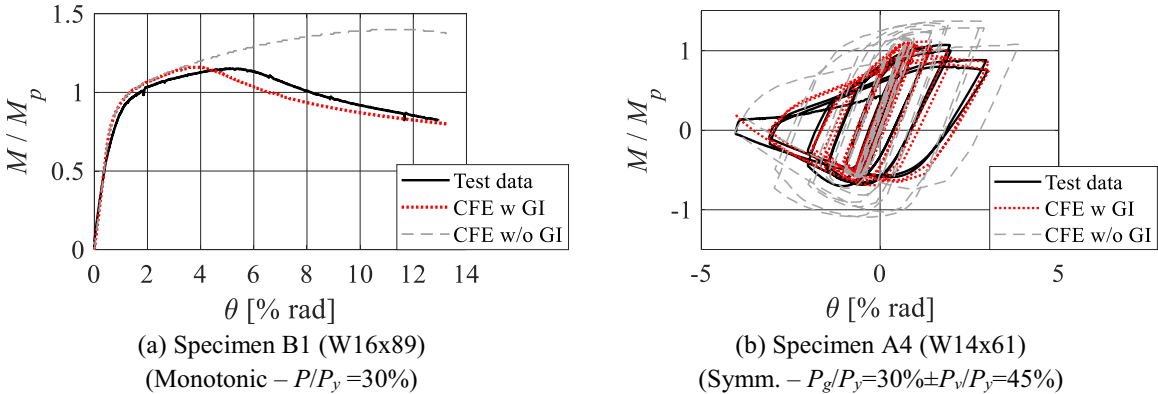

1057 Fig. 17. Comparisons between CFE predictions and measured steel column hysteretic response.

1008 **List of Figures**

1009

1010 **Fig. 1.** Overview of the test setup for experimental testing of cantilever steel column specimens
 1011 [Dimensions in mm].....36

1012 **Fig. 2.** Typical column specimen detail (Group A) [Dimensions in mm].....37

1013 **Fig. 3.** Employed loading protocols for experimental testing of steel columns.....38

1014 **Fig. 4.** Illustration of deduced out-of-plane column deformation and in-plane flange deformation
 1015 based on LED measurements.....39

1016 **Fig. 5.** End moment versus chord-rotation relation of tested specimens [triangular markers
 1017 indicate onset of local buckling].....40

1018 **Fig. 6.** Column axial shortening versus chord-rotation relation of tested specimens.....41

1019 **Fig. 7.** Out-of-plane and flange tip displacements versus chord-rotation of selected specimens..42

1020 **Fig. 8.** Typical damage progression and geometric instability modes [*LB: Local buckling].....43

1021 **Fig. 9.** Evaluation of ANSI/AISC 360-16 axial force-bending (P-M) interaction curve.....44

1022 **Fig. 10.** Variable axial load demands and corresponding column axial stiffness deterioration...45

1023 **Fig. 11.** Assessment of column plastic hinge length.....46

1024 **Fig. 12.** Comparison of column specimens with different cross-section depths and end boundary
 1025 conditions.....47

1026 **Fig. 13.** Typical column repairability curves.....48

1027 **Fig. 14.** Assessment of PEER/ATC 72-1 modeling guidelines for monotonic and first-cycle
 1028 envelope curves of wide-flange steel columns.....49

1029 **Fig. 15.** Ratio of theoretical-to-measured rotational stiffness for several past experimental
 1030 programs.....50

1031 **Fig. 16.** Assessment of predicted (a) pre- and (b) post-capping plastic rotations of wide-flange
 1032 steel columns based on PEER/ATC 72-1 modeling recommendations.....51

1033 **Fig. 17.** Comparisons between CFE predictions and measured steel column hysteretic
 1034 response.....52

1035