



HAL
open science

Experimental observation of low-frequency interactions at different scales and evidence of transit time oscillations in a Hall thruster: Spectral analysis

Quentin Delavière–Delion, F. Gaboriau, G. Fubiani, L. Garrigues

► To cite this version:

Quentin Delavière–Delion, F. Gaboriau, G. Fubiani, L. Garrigues. Experimental observation of low-frequency interactions at different scales and evidence of transit time oscillations in a Hall thruster: Spectral analysis. *Physics of Plasmas*, 2024, 31 (7), pp.072110. 10.1063/5.0206369 . hal-04657851v1

HAL Id: hal-04657851

<https://hal.science/hal-04657851v1>

Submitted on 22 Jul 2024 (v1), last revised 31 Jul 2024 (v2)

HAL is a multi-disciplinary open access archive for the deposit and dissemination of scientific research documents, whether they are published or not. The documents may come from teaching and research institutions in France or abroad, or from public or private research centers.

L'archive ouverte pluridisciplinaire **HAL**, est destinée au dépôt et à la diffusion de documents scientifiques de niveau recherche, publiés ou non, émanant des établissements d'enseignement et de recherche français ou étrangers, des laboratoires publics ou privés.



Distributed under a Creative Commons Attribution - NonCommercial 4.0 International License

Experimental observation of low-frequency interactions at different scales and evidence of transit time oscillations in a Hall thruster: Spectral analysis

Keywords: *ID-Hall 2, Cylindrical Hall Thruster, instabilities, breathing mode, ion transit time oscillation, ion distribution function, wavelet*

Q. Delavière–Delion, F. Gaboriau, G. Fubiani, L. Garrigues

@ : quentin.delaviere@laplace.univ-tlse.fr

LAPLACE, Université Paul Sabatier, CNRS, INPT, 118 Route de Narbonne, 31062 Toulouse, France

Version dated 02/05/2024

Hall thrusters are $E \times B$ plasma devices where a large azimuthal electron current is implicated in the formation of a wide variety of instabilities on different frequency scales (from kHz to GHz) and that propagate in different directions. We have focused on a limited number of low-frequency instabilities that could be experimentally observed, such as breathing mode (BM) and ion transit time oscillations (ITTO). There are still grey areas in the understanding of the mechanisms behind these instabilities, which are often described individually, without considering an eventual exchange of information between the different types of instability. Wavelet time-frequency study of the plasma revealed the coexistence and interdependence of distinct instabilities. We suspect a possible interaction between the breathing mode and higher-frequency oscillations leading to ITTOs: it was shown that a transition occurred when the frequency of one of the BM harmonics became a multiple of the frequency of the higher-frequency oscillations. This was also accompanied by a deformation of the ion energy distribution functions (IDF).

Glossary

HT: *Hall thruster*
 ISP: *specific impulse*
 E: *electric field*
 B: *magnetic field*
 RF: *radio-frequency*
 BM: *breathing mode*
 ITTO: *ions transit time oscillations*
 RS: *rotating spokes*
 ECDI: *electron cyclotron drift instability*
 RPA: *retarding potential analyser*
 IDF: *ion distribution function*
 FFT: *fast Fourier transform*
 WT: *wavelet transform*
 PSD: *power spectral density*
 PIC: *particles in cell*
 MCC: *Monte-Carlo collisions*
 LIF: *laser induced fluorescence*

U_d : *discharge voltage*
 I_d : *discharge current*
 V_{c0} : *potential of the cathode in reference to the mass*
 ϕ_{RPA} : *RPA filtering potential*
 I_{RPA} : *ion current collected by the RPA*

ρ_α : *Larmor radius of an α particle (ion or electron)*
 L_c : *the characteristic dimension of the channel*
 \bar{X} : *mean value of signal X*
 ε_i : *ionisation cost*

I / Introduction

Invented between the 1960s and 1970s in the USSR by Morozov and his colleagues [1], Hall current thrusters,

commonly known as Hall thrusters or SPT (Stationary Plasma Thruster), are a type of electric propulsion system for spacecraft. The Hall thruster is now the main type of propulsion system used on geostationary satellites [2] and the use of electric propulsion systems is set to become even more prevalent due to the ongoing trend towards complete electrification of propulsion and attitude control systems. Although their thrust is lower than chemical thrusters, their ISP (proportional to the exhaust velocity) is much higher [3] [4].

I.1 Operation of a Hall thruster

A Hall thruster is made up of several components, consisting of the thruster block itself and an emissive cathode. The thruster block consists of a magnetic circuit, a gas injection and uniformization system, along with an anode. The propellant gas is injected through the anode, at the bottom of an annular channel, the walls of which are made of a dielectric material. The role of the cathode is to supply electrons to the thruster, to initiate and maintain the discharge, and to neutralize the extracted ion beam to keep the plasma electrically neutral. The emissive element of the cathode made of LaB₆ is heated close to 1600°C by Joule effect thanks to an electric current flowing in a resistive element. The emissive material then releases electrons into a cavity in which some of the propellant gas has been rerouted. It is additionally subjected to an electric field, which greatly increases the extraction of electrons. The extracted electrons then collide with the gas atoms, ionising them. This primary plasma then serves as the electron source for the propellant.

The principle of operation of a HT is relatively simple: a DC voltage of a few hundred volts is applied between the cathode and the anode, and a magnetic field of a few tens of mT, mainly radial, is imposed throughout the channel. The intensity

of the magnetic field is chosen to trap only the electrons and not the ions, which results in $\rho_e \ll L_c \ll \rho_i$ where ρ_α is the Larmor radius of an α particle and L_c is the characteristic dimension of the channel.

In a HT, the plasma is created by ionisation via electron impacts: some electrons emitted by the cathode enter the channel through its exhaust, and are accelerated as they travel up the electric field towards the anode. On their way, they pass through an area with a strong magnetic field that confines them. At the same time, the propellant atoms (usually xenon or krypton) are injected homogeneously from the bottom of the channel and diffuse upwards along it. When they cross the magnetic barrier, they collide with the electrons trapped in the magnetic field.

To ensure an efficient ionisation, it is necessary for the propellant atoms to collide with sufficiently energetic electrons. However, to initiate and maintain the discharge, many ionisation reactions and therefore collisions are necessary. This is why the use of a magnetic field is justified: as the electrons are trapped in the magnetic barrier, their residence time is considerably increased, which significantly increases the probability of ionising collisions. As a result, this type of device is one of the most effective for ionising a gas, achieving ionisation rates of over 80% assuming that only singly ionised ions are created.

When ionisation occurs, an electron-ion pair is created. The electron remains trapped by the magnetic field and diffuses towards the anode through collisions and instabilities. Ions are immediately extracted and accelerated by the electric field, which generates the thrust, or it is lost on the dielectric surface of the channel; which contributes to the erosion of the channel [5]. Finally, the ion beam is neutralised by electrons coming from the cathode.

We note that the operation of a HT requires an electric field and a magnetic field perpendicular to each other. This configuration generates a strong electron drift current in the direction of the $\mathbf{E} \times \mathbf{B}$ product. To avoid the loss of electrons at the walls (and the associated Hall effect), the thruster designers came up with the idea of closing the channel in on itself by giving it an annular shape [1], thus closing the azimuthal drift of the electron current. This configuration is known as a closed drift configuration. The combination of electric and magnetic fields, together with the strong azimuthal electron current and any inhomogeneities in the plasma or system, creates a source of energy that leads to the development of various instabilities.

I.2 Instabilities in a Hall thruster

Low-pressure cross-field plasma sources, including HT, produce a wide variety of instabilities that can lead to regular [6] or transient [7] oscillating phenomena or lead to turbulence [8], [9]. It has been experimentally observed that these instabilities cover a wide range of frequencies, from a few Hz to several GHz, for wavelengths ranging from a few cm to less than one mm. They are also capable of propagating in both axial and azimuthal directions.

Studied experimentally and theoretically over decades, and more recently using numerical models, there remain many grey areas as to the exact properties and nature of certain instabilities. In addition, to avoid excessive complexity,

the most complete theoretical models only look at one instability at a time, ignoring the possible couplings and feedback loops between the different plasma instabilities, and the interactions that may occur between phenomena on different scales. However, understanding the complex dynamics of these instabilities in time and space is a key point in solving the electron transport problem through a magnetic barrier. In this article, we will focus only on low-frequency oscillations (< MHz).

I.2.1 Axial instabilities

We can distinguish two main categories of oscillations propagating in the axial direction that can coexist despite being at different frequencies. The physical mechanisms governing their behaviour are also different.

I.2.1.a The breathing mode (BM)

The first instabilities take the form of oscillations with long periods and relatively high amplitudes on the discharge current and also on the overall luminosity of the plasma [10]. Their frequency range is from a few kHz to a few tens of kHz. They were discovered after the invention of the Hall thruster [1] and have regularly been observed since in [10], [11], [12], [13], [14], [15], [16], [17], [18]. These oscillations are strongly dependent on the shape and intensity of the magnetic field [19], [20], on the applied discharge voltage, the gas flow rate and the material making up the channel walls [1], [20]. In some cases, these oscillations are strong enough to extinguish the discharge or damage the electrical power unit. The characteristic shape of the discharge current, with its strong oscillations, is not dissimilar to a predator-prey model (Lotka-Volterra). Different studies that explored this similarity [21] have shown that the oscillation frequency was related to the gas flow and the ionisation rate in the HT channel. More developed models have been proposed to justify the observed behaviour. We might mention in particular the 1D hybrid model developed by Garrigues & Boeuf [22] from which the following explanation is given: the triggering of oscillations is caused by the fact that in a HT, the ionisation process can be so efficient that all the neutrals present in the ionisation zone are ionised faster than the flow of gas can replace them, thus, the ionisation front moves deeper into the channel, towards the anode. This leads to a reduction in ionisation efficiency (the magnetic trapping of electrons is less effective as we move closer to the anode), which can lead to a quasi-extinction of the discharge, allowing the neutrals to repopulate the channel (i.e., the ionisation region). As the ionisation restarts, the neutrals are again depleted, and so on. The alternating nature of this instability is the reason behind its name "breathing mode" (by analogy of the inhalation of air/neutral gas during BM's phase 1 and the consumption and expulsion of combustion products/ionisation and extraction of ions during phase 2). More sophisticated models were then developed [23], [24], but it remains difficult to simulate/predict the properties of BM due to the different mechanisms involved being interdependent.

I.2.1.b The ion transit time oscillations (ITTO)

Although BM-type oscillations have already been studied extensively, relatively few are actually complete, in

particular experimental studies of instabilities occurring at frequencies between a few tens and a few hundreds of kHz. These frequencies correspond to the inverse of the time of flight required for the ions to cross the acceleration zone, hence the name ion transit time oscillations given to oscillations within this frequency range. These oscillations leave their mark on the discharge current, where they generally coexist with other oscillations such as the BM, but they are usually less prominent. Similar oscillations can be found in certain fluid [25], [26], hybrids [27] and PIC-MCC models [28]. Based on the descriptions provided by the literature, we can say that one of the major characteristics of ITTOs is the presence of oscillations in the potential distribution in the thruster channel, and also in the first few cm of the plume. These oscillations in the electric field have a significant impact on the acceleration of the ions: during one part of the oscillation, a fraction of the ions surf on the electric field wave [6] and therefore always see the maximum electric field, which gives them an additional acceleration, sometimes bringing their kinetic energy to more than that provided by the applied potential energy. During the other half of the oscillation, some of the ions are accelerated less efficiently and gain less speed because they do not see the full potential difference. These changes in the speed of the ions distort the IDF, disrupt the ion currents (and consequently also the discharge current, which is the sum of the ion and electron currents) and modify the ion density profile over time (bunch emission due to the segregation of ions as a function of their speed), which all have a feedback effect on the potential distribution. However, there are points of divergence between more recent studies and older Soviet ones carried out in the early days of HT. Contemporary models contradict the hypotheses put forward at the time : ITTOs were described as quarter-wave resonators that would impact electron movements [29]. It should be remembered that on early HTs, the magnetic barrier was positioned deeper in the channel than in modern HTs. It should also be noted that the configuration of the ID-Hall 2 thruster is halfway between these two configurations.

1.2.2 Azimuthal instabilities

Azimuthally propagating modes have been observed in the HT channel and more generally in E×B devices. These include ECDI/EDI: electron drift instabilities, in the MHz range [30], [31] and rotating spokes (RS). RS manifest themselves by an azimuthal displacement of coherent structures resulting in variations in luminosity, potential and discharge current at frequencies of the order of a few kHz to a few tens of kHz [32], [33], [34], [35]. Their azimuthal displacement speed is an order of magnitude lower than the speed of the E×B drift current [34]. In many experimental studies, the RS are observed together with other instabilities, such as the BM [36]. It has recently been shown that the BM and RS can be interdependent, leading to axial-azimuthal coupling of the RS, which then describes a helical movement within a BM cycle [36]. The combination of fast imaging and the use of a segmented anode has highlighted the fact that almost 50% of the total discharge current flows through the luminous structures of the RS, even though the RS occupies only about 1/4 of the channel surface area [34].

In this article we look into the signatures of these oscillations on different types of signals. First, in sections III.1.1 and III.1.2 we identify different oscillation regimes as a function of parameters such as discharge voltage and gas flow rate, and

discuss the characteristics of these different oscillations identified on the time series of the discharge current and a capacitive signal. In each of these oscillation regimes the discharge, ion and average electron currents are also studied, as well as the energy cost of extracting an ion. Then, in section III.1.3, we discuss the characteristics of the mean ion distribution functions, pointing out in particular the existence of an asymmetry of the IDF in one of the oscillation regimes identified previously, in which a doubling of the amplitude of the discharge current oscillation was observed. Finally, in section III.2, we present the results of using a time-frequency analysis technique called the wavelet transform. This diagnostic is used to highlight the links between the different oscillations taking place at different times and/or at different frequencies. Section III.2.1 is devoted to a brief introduction to the method itself, while section III.2.2 shows the application of the method to the time series of the discharge current and a capacitive signal picked up outside the vacuum vessel. Finally, section III.2.3 describes the oscillations detected in the ion current, the temporality of which is revealed by wavelet transforms.

The detection of different phenomena moving in the azimuthal direction was carried out using a segmented anode composed of three electrically independent segments all recording the discharge current. In this paper, we have only qualitatively described the zones where RS could exist and whether their presence might have an impact on the rest of the discharge.

II / Experimental set-up

II.1 The ID-Hall 2 thruster

The results presented in this paper were obtained by using the experimental ID-Hall 2 thruster (Inductive Double stage Hall thruster, version 2). Figure 1 shows a schematic view of the ID-Hall 2 thruster, its magnetic field lines and their strength. This is a low-power thruster, operating between 80 and 400 W. The ID-Hall 2 thruster, like its predecessor ID-Hall, was designed and built by the LAPLACE laboratory in Toulouse, with the support of the French space agency CNES. The characteristics of the ID-Hall experimental thruster and its

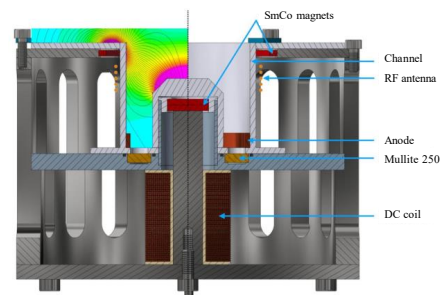

Figure 1: Schematic view of ID-Hall 2 thruster and associated magnetic field lines. The colormap indicates the norm of the magnetic field, from cyan for the lowest B values (<2.5 mT), to dark pink for the highest B values (>4.75 mT). This figure has been modified from [10].

This is the author's peer reviewed, accepted manuscript. However, the online version of record will be different from this version once it has been copyedited and typeset.

PLEASE CITE THIS ARTICLE AS DOI: 10.1063/1.5206369

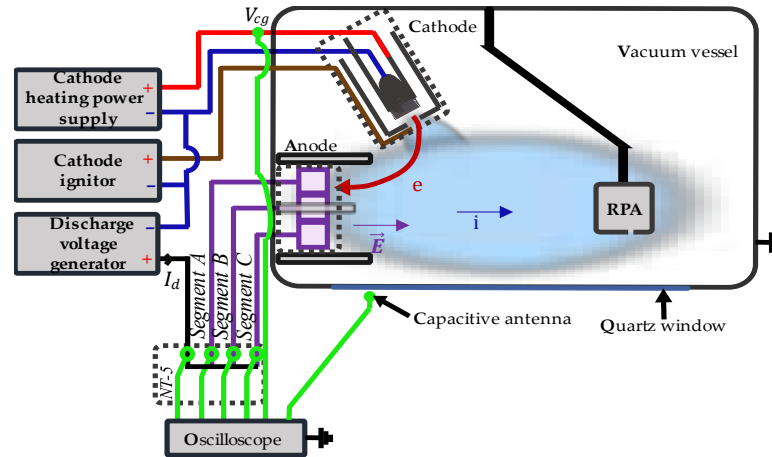

Figure 2: Thruster electrical circuit schematic diagram.

plasma have already been explored and made public in the following publications [7], [10], [15], [36], [37].

The idea behind using a second ionisation source is to facilitate the ionisation of propellants that are more difficult to ionise, such as argon or krypton, but that are more abundant and therefore less expensive. It has also been shown that the addition of RF power can moderate certain instabilities, such as the breathing mode, [15]. ID-Hall 2 incorporates feedback from its predecessor with the aim of improving ion confinement close to the ICP source, in order to reduce the ionisation cost and increase ion extraction efficiency (The RF source consists of a coil of a few copper turns surrounding the outer wall of the channel. In *Figure 1*, these elements are represented by the orange dots). To this aim, it was decided to move the RF ionisation zone closer to the accelerating magnetic field barrier. This meant that the magnetic configuration had to be modified: the magnetic cusp was removed, leaving only a single magnetic barrier, and the anode was placed into a zone with almost zero magnetic field. With this setup, the magnetic field adopts a configuration close to that of cylindrical Hall thrusters. [38] [39]. The bending of the field lines enables the magnetic barrier to cover the ICP ionisation zone and brings it closer to the acceleration zone. The magnetic field is generated by SmCo permanent magnets. The DC coil intended for varying the intensity of the magnetic field is not powered here.

In this article, we will only consider the case of the thruster operating in single-stage mode, i.e., without using the RF coil.

II.2 The test bench

The ID-Hall 2 thruster is mounted on one of the inside faces of a 1 m long and 0.5 meter wide cylindrical vacuum chamber. The chamber is equipped with a pumping system consisting of three turbo-molecular pumps connected to two primary pallet pumps. The pumping rate of the system is 4200 L/s [16]. Without gas injection, the lowest achievable pressure in the chamber is of the order of 10^{-6} mbar (10^{-4} Pa). With gas

injection, the pumping system maintains a pressure of around 10^{-4} mbar (10^{-2} Pa). The pressure inside the chamber is measured using an Adixen ACC 2009 gauge.

In operation, the thruster uses a MIREA-type emissive cathode with LaB₆ [40]. The cathode is heated by the Joule effect by applying an electric current of 14.5 A to the resistive element (the helical wire in the cathode in *Figure 2*) for a power dissipation of 240 W. To preserve the cathode and increase the life time of the heating filament, heating/cooling of the cathode is carried out by incrementally increasing/decreasing the current (0.5 A) sent through the filament. The procedure takes around fifteen minutes. The cathode gas flow rate was maintained at 0.25 mg/s of xenon. The thruster gas flow was varied over a range from 0.4 to 1.2 mg/s of xenon. Flow rates were controlled by Brooks mass flow controller 5850TR and Bronkhorst mass flow meter EL-FLOW.

To be more representative of space flight conditions and as we see in *Figure 2* with the blue wires, the thruster's electrical system, which includes the anode, cathode, keeper (ignitor), and their respective power supplies, is kept floating in relation to the ground (here, the metal housing of the vacuum vessel), this potential is called the cathode common. The discharge voltage is supplied by a Delta Electronika SM-400-AR-8 power supply.

II.3 Diagnostics

II.3.1 Measurement of time varying properties

The discharge current is measured using a Bell-NT5 magneto-resistive sensor. This sensor is positioned in the electrical circuit between the anode and the discharge voltage generator (green circles in *Figure 2*). The discharge current flows through the sensor, which returns a voltage proportional to the discharge current. This voltage is then acquired directly by a digital oscilloscope with an input impedance of 1 MOhm. The oscilloscope used throughout the study is an Agilent

Infinium MSO9254A. The following quantities are also measured directly on the oscilloscope:

- The potential difference between the cathode and the ground, noted V_{cg} (measured on the green point in *Figure 2*).

- The voltage on a capacitive antenna placed outside the chamber, against the side quartz window of the vessel. This antenna records all the electromagnetic and potential disturbances induced by the plasma, without undergoing any charge recombination on its surface. The probe was moved along the 42 cm of the quartz window and no significant change in the shape of the signals was observed between the different locations, the amplitude that decreased as the antenna was moved further from the thruster. Below about ten MHz, the signals measured on two antennas placed at the extremities of the window remained coherent and no significant phase shift was measured.

II.3.2 Faraday probe

A Faraday probe is an instrument commonly used to measure the ion flow [41]. When mounted on a rotating arm, it can also be used to estimate the divergence of the ion beam. By knowing the collection surface of the probe, it is possible to determine the total ion current I_l extracted from the thruster. Then, by subtracting the ion current to the discharge current I_d , we determine the electron current I_e coming from the cathode. The Faraday probe measurements were carried out using a two-sided flat probe with guard rings. The probe and the protocol are described in [10], [16], with the exception that the measurement points were recorded manually using a multimeter. It should be noted that the measurements were carried out at different angles to the thruster axis, to obtain the angular distribution of the ion current. To determine the total ion current, assuming axisymmetry of the discharge, a hemispherical integration is performed.

II.3.3 IDF averaged over time

To measure the mean distribution functions of the ions in the thruster plume, we used an RPA (Retarding Potential Analyser) with four grids. It was designed and built by the GREMI laboratory in Orléans in 1998; design details are available here [42].

The aim of this instrument is to filter ions according to their kinetic energies, so that only selected ions are detected and contribute to the measured current. The first grid is called the screening grid and is used to isolate the plasma from the instrument's own electric field, and is left floating. The second grid is the electron repulsion grid. As its name states, its role is to repel the electrons from the plasma, allowing only the ions to pass through. It is polarized negatively at -35 V, corresponding around 5 to 6 times the electron temperature in the plume. The third grid is the ion discrimination/filtering grid. It creates the potential barrier through which only sufficiently energetic ions can pass and therefore contribute to the collected current. The last grid is also an electron repulsion grid. Its role is to send back the secondary electrons emitted by the collector due to ion bombardment. It is polarized at -40 V. Via recombination, the ions impacting the collector induce a current $I_{RPA}(\phi_{RPA})$, which can be measured using an oscilloscope, and which is proportional to the flow of ions with an energy greater than the

minimum energy ϕ_{RPA} required to cross the potential barrier. We note f the ion velocity distribution function (IVDF):

$$f(\phi_{RPA}) \propto -\frac{dI_{RPA}(\phi_{RPA})}{d\phi_{RPA}} \quad (1)$$

It is necessary to apply a correction to compensate effects of the potential difference between the electrical system of the thruster, which is free-floating, and the RPA, which is referenced to the ground. To do this, we subtract $q_i V_{cg}$ from the measured ion energy, with $q_i = 1$ (only singly charged ions).

Before calculating the IDF, it is essential to filter the measured signals to reduce the noise, which would then be exacerbated by the calculation of the derivative shown in equation (1). To accomplish this, the Savitzky-Golay (SG) algorithm is used [43] [44]. The obtained IDFs are then also processed by the SG algorithm for a final filtering.

III / Results & discussion

During the experimental characterization of the ID-Hall 2 thruster, numerous oscillations were observed. The results presented here focus on the single-stage operation of the thruster, i.e. without RF power injection, like a conventional cylindrical Hall thruster.

III.1 Oscillation regimes

Since ID Hall-2 has a magnetic field imposed by permanent magnets, the only parameters that can be modified to study the plasma behaviour are the thruster gas flow rate and the discharge voltage applied between the anode and cathode. The gas used in single-stage mode is exclusively 99.99% pure xenon. The gas flow rate and the power dissipated in the cathode are fixed and kept constant for all experiments.

III.1.1 Current evolutions

Figure 3 shows the current-voltage characteristic of the thruster for a gas flow rate fixed at 0.9 mg/s. It can be seen that the average discharge current follows a classic pattern already observed as the discharge voltage increases [20]. At low voltage, the mean value of the discharge current \bar{I}_d quickly increases with the discharge voltage U_d , rising from 0.6 to 1.0 A for an increase of 70 V. This increase can be explained by the fact that we are in a zone where the ionisation efficiency rises sharply with the addition of electrical energy and therefore with the increase of electron energy. The increase in the ionisation efficiency was demonstrated experimentally by observing the increase in the total ion current I_l with a Faraday probe in *Figure 4*. If we assume that all the ions created are singly-charged, the ionization rate, estimated by calculating the ratio between the ion current and the theoretical maximum ion current if all the gas is ionized once (represented by the dark blue dotted line), rises from 50% to 80%. The measurements, illustrated in *Figure 4a*, were carried out at a gas flow rate of 0.6 mg/s. As the discharge characteristics are similar and the evolution of the ion current increases proportionally to the increase of the propellant gas flow rate (blue curve in *Figure 4b*), we can assume that the results are of the same order of magnitude; for a flow rate of 0.9 mg/s, a measurement was carried out for $U_d = 250$ V and the ionisation rate was estimated at 88%. Above 175 V and up to

This is the author's peer reviewed, accepted manuscript. However, the online version of record will be different from this version once it has been copyedited and typeset.

PLEASE CITE THIS ARTICLE AS DOI: 10.1063/5.0206369

250 V, the average discharge current inflects and decreases slightly, from 1 A to 0.925 A. It then remains constant up to 335 V. In the literature, this zone is known as the plateau zone [20]. In this regime, the maximum ionisation of the propellant is reached and the ion current is almost unchanged (there is also a plateau on the ion current curve in Figure 4a). At higher discharge voltages, the discharge current increases due to an increase in the electron current coming from the cathode (red curve in Figure 4a) which can be linked to a change in the electron conductivity in the magnetic barrier. As can be seen in Figure 5, this change in electron mobility across the barrier also causes a considerable increase in the cost of ionisation of a gas atom. This reflects the fact that an increasing proportion of the created ions are lost on the walls, which also increases the secondary electronic emission on the ceramic walls. The electron current I_e is obtained by subtracting the total ion current I_i from the discharge current I_d and the effective ionisation energy cost is calculated as follows: $\varepsilon_i = U_d I_e / I_i$. Our exploration of the thruster operating range was limited at high voltage by the maximum voltage of the generator (408 V). The lower limit is imposed by the plasma itself: below 105 V, it is no longer possible to maintain a stable discharge. The values of the ion and electron currents measured show that the thruster used in our study can be considered representative of cylindrical thrusters [38].

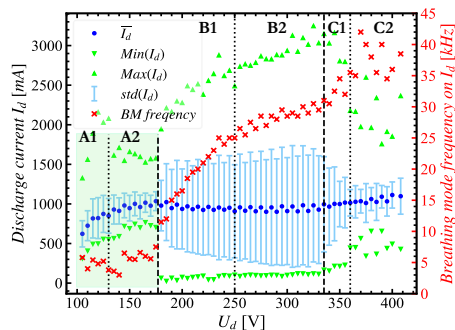

Figure 3: Thruster characteristics for 0.9 mg/s of xenon. The blue dots represent the mean discharge current, the green triangles mark the extrema of the discharge current (the minimum / maximum for those pointing downwards / upwards) and the cyan error bars symbolize the standard deviation of the oscillations. In red, on the right-hand axis, the frequency of the main oscillation (breathing mode).

If we now observe the evolution of the discharge current as a function of U_d , we can see that oscillations are always present. In Figure 3, these current oscillations are represented by the extreme values and standard deviation of the current time series. At low voltage, the oscillations tend to be of low amplitude, although two sub-regimes of oscillation can be distinguished. At very low voltage, the maximum amplitude of the oscillations increases as the voltage U_d increases (regime A1), until the oscillations stabilise with smaller amplitudes (regime A2). Figure 6 plots the discharge current over a period of a few oscillations. At very low voltage (110 V in this case), the oscillations are very irregular, with unstable BM oscillations in both frequency and amplitude. We can also see the higher

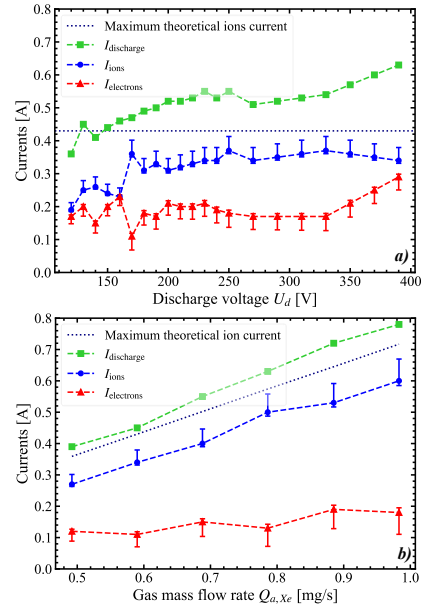

Figure 4: Average discharge I_d , ions I_i , and electrons I_e currents as a function of the: discharge voltage for 0.6 mg/s of gas injected into the thruster channel: a) (top graph); the gas flow rate injected through the anode for a discharge voltage set at $U_d = 250V$: b) (bottom graph).

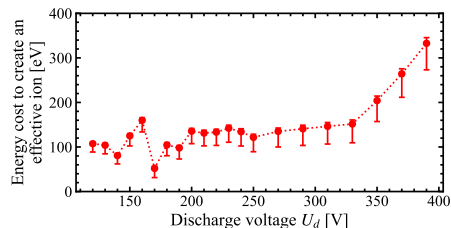

Figure 5: Evolution of the effective ionisation energy cost of a xenon atom as a function of the discharge voltage for a gas flow rate fixed at 0.6 mg/s.

frequency oscillations that are triggered when the current is at its maximum. The frequency instability is also clearly visible on the discharge current spectrogram (Figure 7), where we can see that the width of the frequency range swept by the BM extends from 3 to 8 kHz. When increasing U_d above 130 V, the BM becomes progressively more regular and increases its oscillation frequency. An example of the current is given in Figure 6, for $U_d = 150V$. The intermittent nature and imperfect periodicity of fast oscillations make it difficult to capture their frequency using a FFT, which nevertheless gives us a frequency range of between 100 and 200 kHz. In this range of low voltage operation, we observed azimuthal variations in the discharge current at frequencies of the order of tens of kHz, which could be assimilated to RS. In Figure 3, the transparent green area

This is the author's peer reviewed, accepted manuscript. However, the online version of record will be different from this version once it has been copyedited and typeset.

PLEASE CITE THIS ARTICLE AS DOI: 10.1063/5.0206369

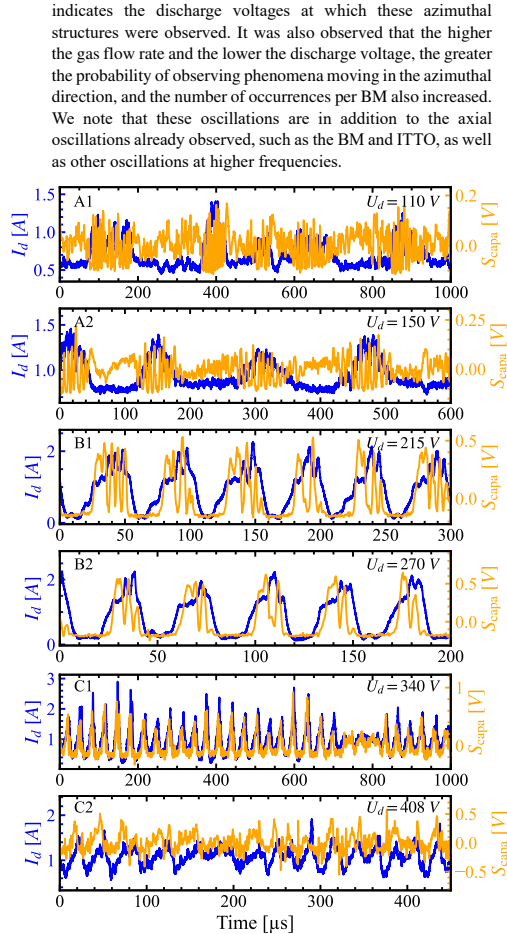

Figure 6: A few time series in each of the regimes identified in Figure 3, with: in blue, the discharge current and in orange, the voltage of the external capacitive antenna.

When increasing U_d , there are significant changes in the shape, amplitude, and frequency of the oscillations. The amplitude of the oscillations doubles and can exceed 3A, and the current also passes practically through zero at the minimum of the BM. These oscillations can lead to temporary extinction of the discharge. The spectrogram in Figure 7 shows that the frequency of the BM increases rapidly for $U_d \in [175 - 250]$ V (regime B1), before slowing down for $U_d \in [250 - 335]$ V (regime B2). The frequency range of the fast oscillations remains the same as that identified previously, so the number of fast oscillations per BM cycle decreases as the discharge voltage increases (since the BM period decreases). It can also be seen that for each voltage, the frequency of BM oscillations stabilizes around a central frequency with a small dispersion of merely a few kHz. In addition, the first harmonics of this frequency

become much more pronounced, to the point where we can observe an overlap between the frequency domain of fast oscillations and certain harmonics of the BM (between the 4th and the 7th).

If the discharge voltage is increased further, alternations between different oscillation modes can be seen in Figures 3 & 6. A first transition zone can be defined for $U_d \in [335 - 360]$ V where BM oscillations are still present but alternate between high and low amplitude modes, 2.5 and 1A respectively (C1 regime). For higher voltages $U_d \geq 360$ (C2 regime), low-amplitude BM oscillations alternate with oscillations of reduced amplitude (0.4A) and higher frequency (between 150 and 250 kHz), which more closely resemble the rapid oscillations previously found when the discharge current was at its maximum. These changes are associated with a loss of regularity in the oscillations, resulting in a widening of the frequency range, a reduction in the spectral power density and the disappearance of the BM harmonics from the spectrogram.

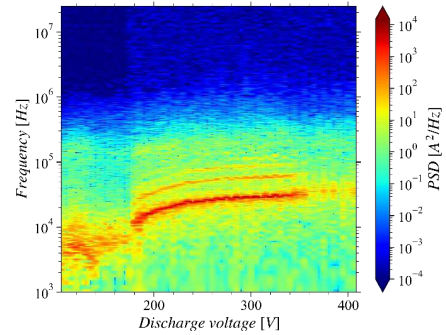

Figure 7: Spectrogram of low-frequency oscillations in the discharge current of the thruster for 0.9 mg/s of xenon. The time series were measured every 5V with a sampling frequency of 50 MHz. (To generate this image, a zero-order spline interpolation was performed).

An analysis of the characteristic in Figure 3 also reveals a hysteresis phenomenon: alternations can be seen in both the mean current, standard deviation and in the extreme values reached along with the frequency of BM oscillations. To understand the origin of this phenomenon, we need to take a closer look at the experimental measurement protocol: starting from one operating point of the thruster, the discharge voltage is increased by a 10 V step. Then, once the maximum voltage has been reached, the voltage is shifted by 5V and decreased again by 10V, a reversed operation is carried out when the minimum discharge voltage is reached. This procedure shows that the plasma does not behave in the same way when the discharge voltage is raised and lowered. We also note that the plasma requires a few seconds to a few minutes to stabilize after each change in its operating conditions. This difference could be dictated either by the time taken to reach a new thermal equilibrium with the walls [45], or by a change in the surface state of the ceramics due to their temperature [46] or to the deposition/spraying of particles such as ceramic, steel or/and aluminium in the enclosure, or by all three phenomena at once. This would underline the sensitivity of the BM to secondary

electron emissions. In addition, close to the transition discharge voltages, the standard deviation also reflects the proportion of time spent in each of the oscillation modes. Thus, we can see that the transition between two regimes is not well defined and does not occur for a very precise voltage. Instead, we have a hysteresis at the transition point between regimes and therefore a shift in the transition discharge voltage depending on the previous state of the plasma. The switch between regimes is thus delayed towards the high voltages, respectively the low voltages (of about twenty volts) when the discharge voltage applied to the plasma is progressively increased (respectively decreased). This highlights the nonlinear nature of the physics governing plasma discharges in HT.

Although the thruster used in our study is very different from the STP-100ML, a striking similarity in terms of frequency distribution with the increase in discharge voltage and in particular the BM frequency can be observed between our spectrogram and the one shown in Figure 5 of the article [21]. This could be attributed to the use of ceramics made from the same material: BN-SiO₂.

Let us now focus on the fast oscillations. Fast oscillations are defined as oscillations whose frequencies are at least one order of magnitude higher than the BM frequency. In the current vs. time graphs in Figure 6, it can be observed that these oscillations are primarily present when the discharge current is at its maximum during a BM oscillation. It is also noticeable that the number of fast oscillations per BM cycle decreases with the increase of U_d . These oscillations have frequencies ranging from a few tens to a few hundreds of kHz. For a gas flow rate of 0.9 mg/s, the analysis of the FFTs associated with the discharge current indicates that these fast oscillations cover a relatively wide frequency range, ranging from 30 to 200 kHz for $U_d = 115V$ and from 200 to 500 kHz for $U_d = 315V$.

In regime A, the frequencies of the fast oscillations do not appear to change significantly when the discharge voltage is modified. Considering that increasing U_d leads to an increase in the BM frequency (i.e., a decrease in its period), this explains why when the discharge voltage is increased, fewer fast oscillations are observed per BM cycle.

In regime B, we see far fewer rapid oscillations per BM cycle, just a few and sometimes just one, with the number of occurrences decreasing with an increasing U_d . Their amplitude distribution also changes: the first oscillations have a very low relative amplitude, whereas the last oscillations appearing during a BM cycle are more noticeable. The frequency of these oscillations seems to be constrained by the period of the BM, which would exert a forcing effect on these faster oscillations. It is interesting to note that in this regime, the appearance of fast oscillations leads to an increase in the maximum discharge current, sometimes even doubling it. We might therefore assume that there is possibly a resonant interaction between the fast oscillations and the BM that could explain this change.

In regime C, if the BM is intermittent, the rapid oscillations never cease. Their frequency dispersion is also narrower, centred around 200 ± 100 kHz.

To sum up, based on what we have observed, we can identify the following regimes: a low-frequency BM oscillation regime for $U_d \in [105 - 175] V$ (regime A), a high-frequency BM regime for $U_d \in [175 - 335] V$ (regime B), and an unstable BM regime for $U_d \in [335 - 408] V$ (regime C). In Figure 3, these regimes are indicated by thick black dashed lines. The thin black dashed lines represent the boundaries of sub-domains defined by the frequency stability of the discharge. In all these regimes BM oscillations are present at least transiently and fast oscillations are always present over the BM during the maximum discharge current phase with smaller amplitudes than BM. We will see in section III.1.3 that we found exactly the same delimitations for the thruster operating regimes on the ion velocity distribution functions. Plasma oscillations therefore have a strong impact on the overall behaviour of the ions.

We can add that as U_d increases, an increasing in the luminosity of the plasma and a decreasing in the divergence of the plume is observed. This last observation is in line with the measurement of the divergence of the ion beam by the Faraday probe, where the divergence decreases linearly with the increase in U_d .

III.1.2 Characteristics of the discharge current for several gas flow rates

The thruster behaviour was tested at different xenon flow rates: 0.4, 0.6, 0.9 and 1.0 mg/s. The different characteristics are shown in Figure 8, and the evolutions of BM frequencies are shown in Figure 9. The cases at 0.6, 0.9 and 1.0 mg/s are very similar: they show the same operating modes with variations in amplitude, frequency of BM oscillations, average discharge current and FDI as a function of flow rate. These values all increase with an increase of the flow rate. The most noticeable differences are found in the locations of the different oscillation modes in terms of discharge voltages, shifting about

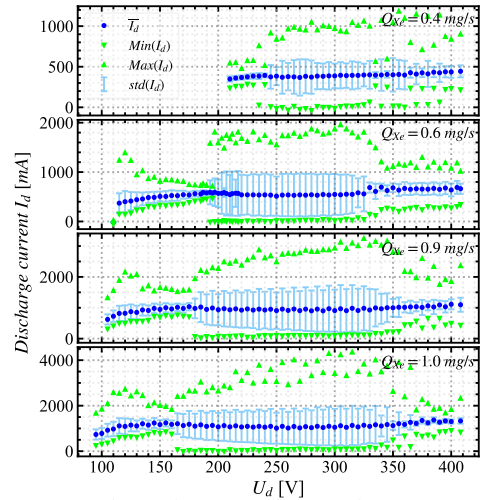

Figure 8: Thruster characteristics from top to bottom: 0.7, 0.6, 0.9 & 1.0 mg/s of xenon.

twenty volts lower for the tested flow rate increment. With a flow rate of 0.4 mg/s, the discharge behaviour is quite different from that observed for the higher flow rates. At low voltage discharge, BM oscillations are relatively rare, and their distribution over time appears quite random. It is also noticeable that fast oscillations (in the order of hundreds of kHz) are present but with very low amplitude (around 50mV).

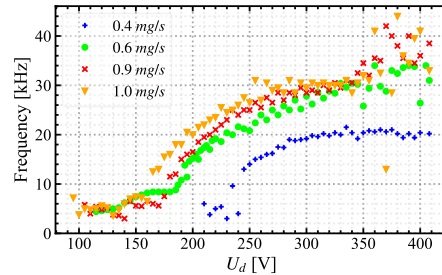

Figure 9: Central frequencies of the BM for the different flow rates tested.

To summarise, at a constant discharge voltage, increasing the gas flow rate results in a higher gas density in the thruster channel and thus increases the probability of electron neutral collisions. Consequently, ionising collisions would increase the density of electrons trapped in the magnetic barrier, leading to even more ionising collisions, and improving the overall degree of plasma ionisation. Since it is established that BM is an instability related to global ionisation in the channel, this explains why the high BM region can exist at lower voltages when the gas flow rate increases. Assuming there are only singly charged ions, for $U_d = 250V$ we do indeed observe a slight increased ionisation rate on Figure 4b. As the electron density increases with the gas flow, the mean free path decreases, which could increase the global ionisation, explaining the dependence of the BM frequency to the gas flow. It is also noticeable that the frequency spread around the central frequencies of the BM increases with the flow rate. So, the BM oscillations might be destabilized with an increase in the gas flow rate.

III.1.3 Time-averaged ion distribution functions

We measured the ion distribution function for different discharge voltages using an RPA. The RPA was positioned in front of the thruster, aligned with the thruster axis, perpendicular to the exit plane and at 41 ± 1 cm from it. Our results are shown in Figure 10 for a gas flow rate of 0.9 mg/s.

Two distinct groups of IDF shapes can be observed: a group of relatively symmetrical distributions with a Gaussian appearance, and a group of asymmetrical distributions resembling the sum of two Gaussian functions shifted with respect to each other. We can note that the different groups of ion distribution shapes correspond exactly to the different plasma oscillation regimes identified as a function of discharge voltage. The behaviour of the ions is therefore closely linked to the characteristics of the discharge.

The IDFs are relatively symmetrical in the regimes of discharge voltage that correspond to low-amplitude BM

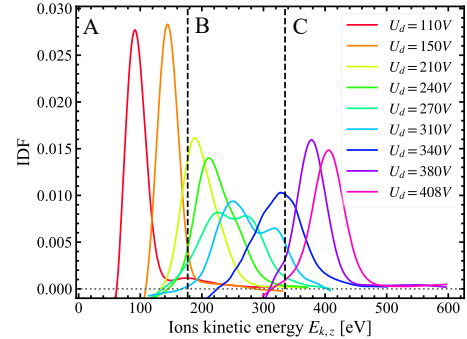

Figure 10: IDF given for some discharge voltages with a xenon flow rate of 0.9 mg/s.

oscillations of the discharge current (regime A), but also in the intermittent areas with medium-amplitude BM (regime C). Under the regime of a high-amplitude discharge current (regime B), the distribution functions are asymmetrical and both widen towards high energies, with the gradual appearance of a second peak on the high-energy side, and strongly towards low energies, displacing the initial probability maximum towards the lowest energies. The second peak becomes stronger at the expense of the low-energy peak as the discharge voltage increases until it becomes dominant, causing the less energetic peak to gradually disappear. When the latter has completely disappeared, the transition to regime C is reached.

While symmetrical distributions with a Gaussian shape are common and relatively easy to explain, this is unfortunately not the case for asymmetrical distributions. There are several possible explanations for these differences including the fact that the IDF are not fixed in time but evolves over time in response to plasma oscillations [16]. To confirm this behaviour, temporal IDF studies are needed.

III.2 Time-frequency analysis

While we have been able to identify the main frequency domains of low-frequency oscillations, it is difficult to carry out a more detailed study using a simple FFT. Two intrinsic problems with the properties of the FFT are particularly limiting. Firstly, the FFT transforms an entire time series into a corresponding frequency spectrum, which excludes temporal monitoring of the evolution of the oscillations. Secondly, by construction, the FFT is very reliable when the phenomenon being studied is stationary, which is not the case here. The result is a relative reduction in the weights of the frequencies corresponding to the least regular oscillations and a spectral broadening on the frequency distributions, which makes the frequency bands of the oscillations harder to discern. The FFT therefore struggles to effectively capture the different frequencies involved, because the oscillations are neither regular, periodic nor stable in frequency and are even intermittent, either because some oscillations are triggered selectively or because different oscillation modes alternate along the time series. The use of moving-window Fourier transforms (also known as the short-term Fourier transform) could be a solution if the frequencies of the oscillations studied did not extend over several orders of magnitude, which is our case.

Wavelet transforms (WT) are another mathematical tool that offers the best compromise between frequency and time resolution thanks to the use of a window that is adaptive to the probed frequency. This allows us to probe frequencies over several orders of magnitude, making it possible to study the behaviour and interactions of instabilities on several scales at once. There are also diagnostics based on wavelet analysis, which can be used to find a possible direction of propagation of information between the scales of the oscillations [47]. It should be noted that wavelet transforms are not the only tools suitable for studying the time-frequency behaviour of a signal. As an example we can also mention the Hilbert-Huang transform [12].

III.2.1 Brief introduction to Wavelets

WTs are used relatively frequently in a number of fields, such as the search for instabilities in fusion, the detection of gravitational waves, medicine (the search for warning signs on ECGs), meteorology and so on. Surprisingly, this type of diagnosis does not seem to be very widespread in the electric propulsion community [48], [49], [50]. In [48], [50], they use WT to extract a averaged frequency spectrum from emissive probe measurement and discharge current. In [49], the authors focus on oscillations from MHz to a few tens of MHz, a frequency range that partially overlaps with ours, which mainly probes with frequency ranges going from kHz to a few MHz.

This article is not intended to provide a detailed explanation of how the WT works. For this purpose, the reader is referred to the documents [51], [52], [53], [54], [55], [56], [57]. Here, we will simply give a general outline. Although similar in appearance, the Gaussian moving window Fourier transform (MWFTs) developed by Gabor, sometimes considered to be the first draft of continuous wavelet theory, and WT are fundamentally different. One of the main differences between MWFT and WTs is that the Fourier transform decomposes the signal into a sum of weighted sines waves, where the sine is a localised function in Fourier space, whereas the WT uses a series of dilated/compressed wavelet functions to scan several scales and thus best match the corresponding pseudo-frequencies of the functions. These functions, known as mother wavelets, can theoretically be chosen arbitrarily, on condition they satisfy certain rules, such as: be an oscillation function with a zero mean, be a summable square function of $L^2(\mathbb{R})$ Hilbert space (be defined in both real and Fourier space).

The wavelet transform $W(\tau, t)$ of a signal $s(t)$ can be expressed using the following equation:

$$W(\chi, \tau) = \frac{1}{\sqrt{\chi}} \sum_{j=0}^{N-1} s(t_j) \phi^* \left[\frac{(t_j - \tau)}{\chi} \right] \quad (5)$$

Where χ is a dilation parameter (time scale parameter), τ is the position parameter (a translation parameter) around which the convolution is performed on a Δt sized window. $W(\chi, \tau)$ is the coefficient of the wavelet transform for a scale factor χ , at time τ . The symbol $*$ designates the complex conjugate and ϕ is a mother wavelet function. Wavelet analysis therefore consists of carrying out a local comparison of a signal with a wavelet function, enabling the signal to be zoomed in on at different scales and at all times in the recorded series $s(t_j)$.

The choice of the scale vector on which to expand the wavelet function must be made carefully. If the chosen scale is too low, aliasing may occur of the Shannon-Nyquist condition is not satisfied. Inversely, a too high scale should be avoided as to not make the dilated wavelet function larger than the input signal. In general, scales are inversely proportional to frequencies.

As a mother wavelet function, we have chosen to use the complex Morlet function, which is the result of the convolution between a sinus wave and a Gaussian function (see Figure 11). The Gaussian shape of the envelope of the Morlet wavelet minimizes the product of the wavelet temporal and frequency resolutions and therefore optimizes the accuracy of the results [54]. This wavelet function has two free coefficients f_0 and β_b .

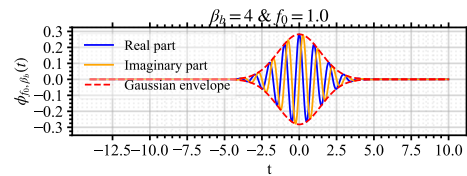

Figure 11: Complex Morlet wavelet function illustration.

$$\phi_{f_0, \beta_b}(t) = \frac{1}{\sqrt{\pi \beta_b}} e^{2i\pi f_0 t} e^{-t^2 / \beta_b} \quad (6)$$

The choice of these coefficients also plays an important role: the optimum value for the central frequency f_0 is 1. Moving away from this value reduces the quality of the time/frequency compromise, increases edge effects, promotes aliasing, and destroys the approximation of the conversion relationship between scales and frequencies. The bandwidth β_b has a direct impact on the balance between frequency and time resolution. It is customary to set it between 3 and 6, and we have empirically set it at 4. The implementation of the WT calculation was greatly facilitated by the use of the open source python library PyWavelets [58].

III.2.2 Wavelet analysis of the discharge

The WT of the time series of the discharge current, the capacitive signal and the ionic current have been calculated and give very similar spectrograms. Indeed, the variations in these signals are highly correlated, especially for fast oscillations, as can be seen in Figure 12 where the coherence of the discharge current and the capacitive signal is plotted. The coherence of two signals is the normalised cross spectral density. It is a statistic

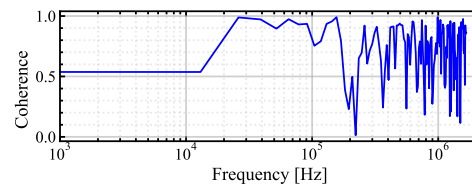

Figure 12: Coherence of discharge current and capacitive signal as a function of oscillation frequency; calculated using matplotlib cohere function with a resampling frequency of 3.3MHz.

that can be used to examine the relationship between two signals for given frequency components. Here on the graph in *Figure 12*, we see that oscillations with frequencies between 30 and 130 kHz are well correlated. The only visible differences between the discharge current and capacitive signal series are in the distribution of the power spectral density: like in the Fourier spectra, the BM oscillation concentrates the power spectral density (PSD) in the frequency space of the discharge current, making the other oscillations less visible. On the other hand, the relative weight of the fast and BM oscillations is more balanced on the capacitive signal, which means that the fast oscillations can be investigated in greater detail.

By studying the graphs in *Figure 6*, we can see that there is an anti-correlation between the fast oscillations on the discharge current peaks (in blue) and the capacitive voltage peaks (in green) occurring at frequencies between a few tens and a few hundreds of kHz. As soon as a pulse is detected by the capacitive antenna, the discharge current starts to increase. As the antenna is located outside the enclosure, a change in its potential means either a change in an electric field and/or in the plasma potential, which tells us about a charge displacement or a reorganization of the plasma propagating into the plume. Disturbances in the plasma potential over a frequency range ranging from 60 to 150 kHz can suggest the presence of ion transit time oscillations.

Since these two signals are correlated in this frequency range, we will illustrate our observations here with wavelet spectrograms calculated from series of the capacitive signal. They have been plotted in *Figure 13*.

Let us look first at the low discharge voltage regimes (A). Starting with the lowest frequencies, we find an initial bright red band that is continuous throughout the spectrum, around 4 kHz for $U_d = 115V$ (A1) and 7 kHz for $U_d = 125V$ (A2) marking the fundamental frequency of the BM. The Fourier spectra are also shown in the panels on the left of the graphs in burgundy red, showing the BM at the same frequency. The frequency band appears wider on the wavelet spectrum than on the Fourier spectrum, because in frequency space, the complex Morlet wavelet function is defined as a Gaussian of non-zero width. This width is a function of the probed frequency and can be seen as an analogy to Heisenberg's uncertainty principle: in time-frequency analysis, we cannot have perfect resolution in both time and frequency space. In this regime we can see that the BM frequency is not stabilised through time: it oscillates by a few kHz during the probed time interval. This is particularly noticeable in the A1 regime, where the period of BM oscillations can vary by several hundreds of μs , and these variations were also observed in the discharge current in *Figure 6*. A period of the BM is bordered by the two dashed lines. When U_d increases, the BM frequency tends to stabilize, approaching a straight line on the spectrogram. As we move up towards higher frequencies, we encounter bands corresponding to the harmonics of the BM. Depending on the oscillation regime, between 2 and 5 harmonics bands can be easily be observed on the spectrogram. By raising the frequency further, between 30 and 200 kHz, we see discontinuous coloured areas, in phase with the areas where rapid oscillations occur when the maximum discharge current is reached, which confirms the intermittent nature of these oscillations. The dotted lines show the development zone for the rapid oscillations on the discharge current. A quick comparison

with the Fourier spectrum immediately reveals the power of the WT: where these oscillations form a small and broadened bump on the Fourier spectrum, very distinct islets appear on the WT. This reveals that there are several types of rapid oscillation that can be divided into two blocks of frequencies, the first oscillating between 20 and 90 kHz and the second between 100 and 350 kHz. In regime A, we can see that the frequencies of the rapid oscillations are not constant over time and that they change as the BM cycle progresses. In the unstable regime A1, the frequency variations seem quite random, although we can guess an increase and then a decrease in the frequency of oscillations evolving between 20 and 90 kHz within certain BM oscillations (such as between 0 and 600 μs). If the oscillations of the lower frequency block occur continuously during the discharge, the oscillations of the upper block occur essentially when the discharge current is at its maximum. In the A2 regime, where the BM oscillations are more stable, we can clearly see a gradual increase in the frequency of the oscillations, which tends to create a frequency continuity between the two previously identified blocks. This frequency shift begins when the discharge current is still minimal and ends when the discharge current has fallen sharply. We can therefore assume that the phenomena at work in these oscillations are active in the ionisation zone, which, as we recall, is strongly impacted by the BM.

Above 700 kHz and up to MHz, flame-like oscillations can be seen on the spectrogram. The apparition of these oscillations is synchronised with the reaching of the maximum of the picked up capacitive signal, which corresponds to the rise in the discharge current due to the fast oscillations previously defined. On the spectrograms, these time instants are indicated by dotted lines. They then disappear during the descending phase of the ITTO oscillations. Note that our Shannon-Nyquist cut-off frequency is 25 MHz, so there are no effects due to the signal sampling. Finally, we find oscillations displaying a similar behaviour around 400 kHz when the discharge current is minimal between two BM oscillations.

To summarise, in the A regime, there are at least 3 levels of instability between kHz and MHz. These oscillations appear intermingled with each other. We observed that when BM oscillations are unstable (in frequency and in shape), ITTO oscillations are also very unstable and evolve chaotically over time on a BM cycle. In contrast, in the A2 regime, when BM oscillations stabilise and become more regular, the evolution of the ITTO frequency is also more regular, with a frequency shift towards the higher frequencies over time during a BM cycle. We can therefore assume that instabilities at lower frequencies periodically create favourable conditions for the emergence of oscillations at higher frequencies.

This is the author's peer reviewed, accepted manuscript. However, the online version of record will be different from this version once it has been copyedited and typeset.

PLEASE CITE THIS ARTICLE AS DOI: 10.1063/5.0206369

Figure 13: Wavelet spectrograms for each of the observed regimes. The central zone is the spectrogram of a time segment of the chosen time series, the x-axis represents time and the y-axis represents frequency. The colour scale is logarithmic and represents the PSD. The white transparent area is the coherence cone; its border marks the area in which the coherence of the WT can be reduced due to edge effects. The red curve on the left is the Fourier spectrum corresponding to the entire time series. The lower graph contains the curves associated with the discharge current (blue) and the capacitive signal in arbitrary units (green).

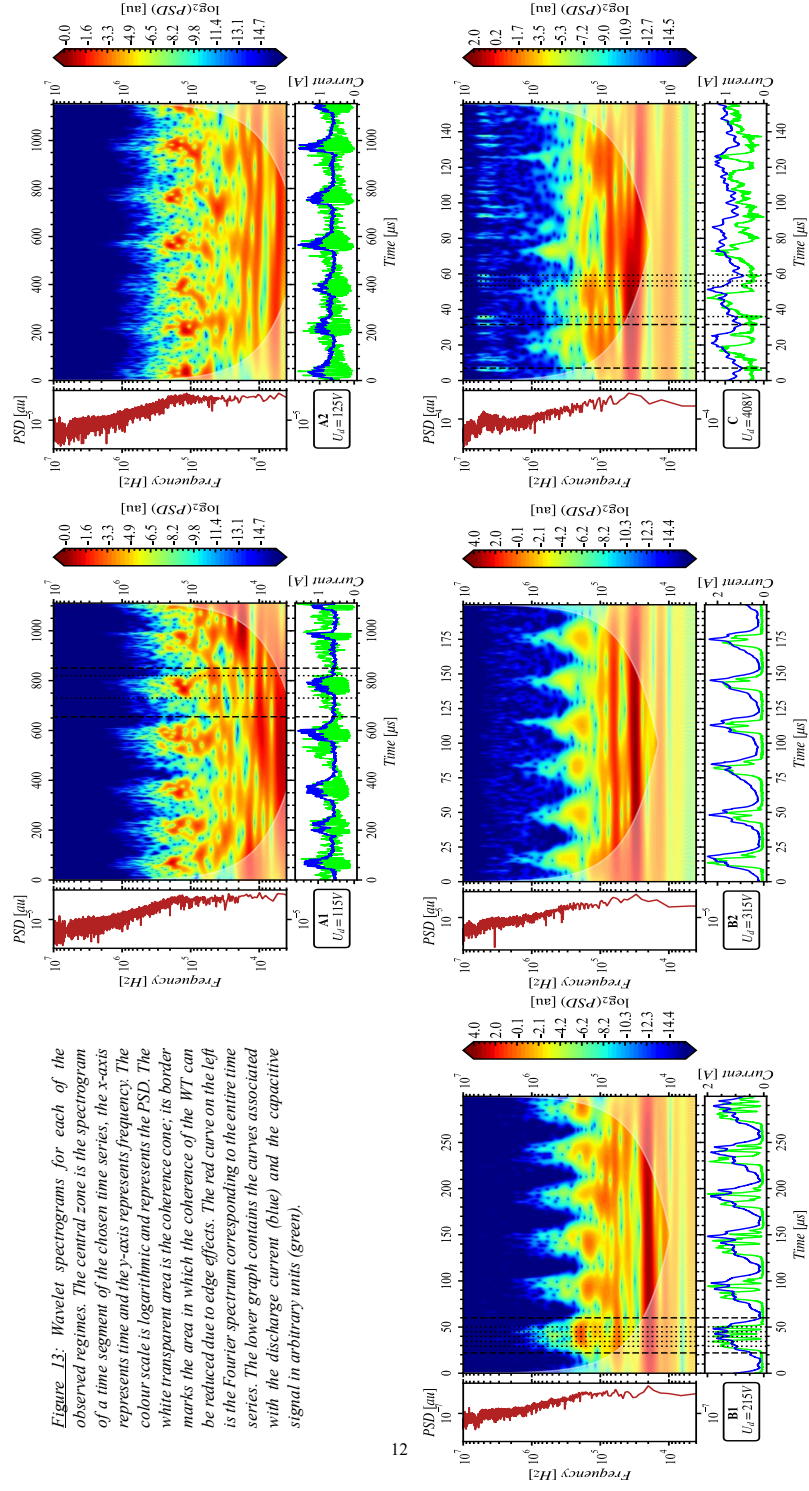

This is the author's peer reviewed, accepted manuscript. However, the online version of record will be different from this version once it has been copyedited and typeset.

PLEASE CITE THIS ARTICLE AS DOI: 10.1063/1.50206369

By increasing the discharge voltage, we enter the high-amplitude BM oscillation regime (B), and we can see that the band corresponding to the BM increases in frequency, which was already highlighted on the spectrogram in *Figure 7*. We can also remark that unlike regime A, in this regime the BM oscillations are very regular, which is reflected in the straightness of the BM bands. With the increasing of the discharge voltage, we can also see on the spectrograms that the 20 to 90 kHz band gives up its place to the bands corresponding to the BM harmonics. However, in the B1 regime, on certain BM oscillations, there are still zones in this frequency band where the spectral power is higher (such as between 70 and 100 μs on the spectrogram at 215V). Only oscillations with a frequency between 100 and 300 kHz remain. There is also a noticeable change in the behaviour of these fast oscillations, which are now perfectly localised when the discharge current is maximum and their central frequency is fixed. It can be observed that the central frequency of these oscillations is juxtaposed with that of one of the harmonics of the BM, located between the 4th and 6th harmonics. Oscillations are no longer found in regimes of low discharge current, which may be too low to maintain the plasma discharge and the richness of its dynamics.

Green peaks can also be seen on the spectrograms at frequencies between 300 and 700 kHz. These peaks are visible at the local maximum of the discharge current during oscillations at around 100 kHz. By probing higher frequencies, oscillations can still be observed between 0.7 and 1.1 MHz. These follow the same dynamics as in regime A. In case B1 where several oscillations are superimposed on the BM, a PSD peak is observed when the capacitive signal is locally maximum during the oscillations at around 100 kHz. At higher frequencies, such as the frequency band between 2 and 10 MHz, oscillation packets gradually appear as U_d increase. At this point, these oscillations seem too random in both time and frequency and have too low a PSD for us to consider them significant compared to the ambient EM noise.

To sum up, in regime B, the oscillations become more regular, whether it is the BM whose frequency and amplitudes are more stable or the oscillations in the hundreds of kHz whose central frequency no longer evolves and overlaps with the frequency of some of the harmonics of the BM. It could be imagined that an interaction between the BM and the fast oscillations via the BM harmonics is helping to stabilise these fast oscillations. In addition, it should be remembered that in this regime the amplitude of the discharge current oscillations doubles, so it could be suggested that there might be some resonance interactions between the two oscillations. Finally, at higher frequencies, oscillations appear temporarily when the local maximums of the discharge current and capacitive signal oscillations are reached.

Finally, in regime C (and as the last cases), we used as an example a discharge voltage of 408 V, we still see oscillations such as the BM, around 14 kHz, and the fast oscillations, between 100 and 400 kHz. However, these oscillations have become unstable, both from a frequency point of view, with the broadening of the frequency bands, and from a time point of view, with different oscillation modes alternating. When the amplitude of the BM is low, between 60 and 100 μs for example, the rapid oscillations are more regular and their frequency is more prominent, which is reflected in the thinness of the

corresponding band on the spectrogram at 100 kHz. Finally, between 3 and 7 MHz, we observe oscillation packets that are synchronised with the local minima of the discharge current during oscillations at 120 kHz and corresponding to a reception of a wave packet on the capacitive antenna (examples are shown on the spectrogram with the location of the thin dotted black bars). We can also see that these MHz oscillations are more visible because their PSD is greater when the discharge current reaches the minimum of the BM. On the other hand, these MHz

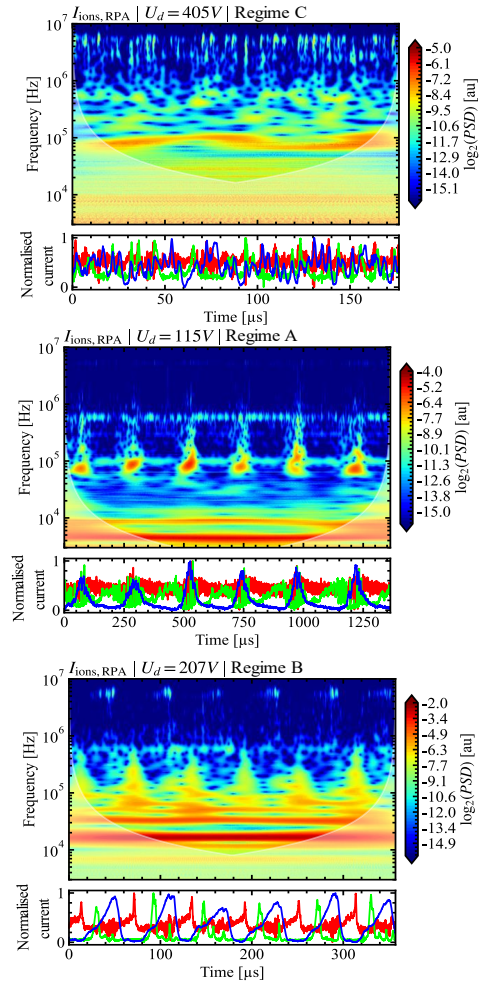

Figure 14: Wavelet spectrogram of time series of the total ion current collected with a RPA for a gas flow rate of 0.6 mg/s and from the top to the bottom, a discharge voltage of 115, 207 and 405 V. The lower graphs plot the discharge currents (in blue), the ion currents (in red, collected at the RPA) and the capacitive signal (in green) on a common time base with the spectrograms.

oscillations are much more visible on the spectrograms of the capacitive signal and the ion current than on the discharge current, where they can only be seen as a trace. This could therefore be an instability affecting the movement of the ions. We therefore need to study the characteristics of the ions in more details.

III.2.3 Ion wavelet analysis

In parallel with the time measurements of the discharge current, the capacitive signal, the coupling potential of the cathode with the ground and the ion current were also recorded. These were made using the RPA placed in the central axis of the thruster with the ion filter grid set to being unbiased, so that the RPA no longer made any selection on the energy of the ions collected, giving us a view of the variation of the ion current. The spectrograms shown in *Figure 14* are taken from the ion current time series for a xenon flow rate of 0.6 mg/s.

The spectrograms in *Figure 14* show several frequency bands. The first band, which is more or less pronounced in each of the spectrograms, is located between 4 and 6 MHz, and we note that the frequency of these oscillations may correspond to the plasma pulsation of the ions. At 115 V, in regime A, these oscillations are episodic, and we cannot really say whether they are anything other than ambient electromagnetic noise. With the rise of the discharge voltage and the transition to regime B, we observe a succession of wave bursts whose intensity increases with time before gradually disappearing when the BM is restarted (when the discharge current increases). In regime C, the MHz oscillations are much more pronounced and there seem to be more occurrences when 500 kHz oscillations are present.

These oscillations around 500kHz are also visible regardless of the discharge voltage. Depending on the oscillation regime, their location relative to other oscillations with longer periods seems to change. They are intermittent and relatively homogeneously distributed in regimes A and C, and appear to be activated when the capacitive voltage inflects. By contrast, in regime B, they seem to be located more often in the time interval corresponding to a low discharge current.

Finally, at lower frequencies, the oscillations are very similar to those already observed on the spectrograms of the discharge current and capacitive signal in *Figure 13*. Particularly in regime A, between 60 and 110 kHz, we can clearly and distinctly see the islands of oscillations previously associated with ITTO when the discharge current is at its maximum. However, we note that there are still oscillations around 100 kHz, although their PSD and therefore their amplitude are relatively low. In regimes A and B, we can clearly see the continuous bands associated with BM oscillations around 5 kHz. In regime C, where the BM is intermittent (on the spectrogram shown here, the BM is not present), we mainly observe the fast ITTO oscillations between 80 and 100 kHz and we note that their frequency is not very stable and depends on the value of the discharge current.

To summarise, the ion current also displays the marks of numerous instabilities, including the signatures of the BM and ITTO, but also other oscillations that we have not been identified, some of which appear to be interdependent or at least dependent on the conditions created on larger scales by the

instabilities with longer periods. We also note that the oscillations around 500 kHz and 4-6 MHz become more pronounced as the discharge voltage increases. This suggests the presence of different physical phenomena, which are more pronounced when the discharge current is low, and which act mainly on the current collected by the RPA. We cannot exclude the possibility that at least one of these oscillations develops because of plasma instability inside the RPA, or is a capacitive signal picked up by the RPA and/or on its wires inside the plasma (the noise-to-signal ratio was evaluated at 6% by comparing the signals collected by the RPA in the plasma with and without a shield in front of the instrument entrance; for a constant discharge voltage and flow rate). The oscillations present in the 4 to 6 MHz frequency range are also observable on the spectrogram of the capacitive signal (and discharge current) at high voltage in *Figure 13* (for $U_d = 408 V$). In the article [59], a similar signature of oscillations was observed on the Fourier spectrum of the discharge current, and were attributed to electron-drift type oscillations.

Conclusion

The study of the discharge current oscillations enabled us to identify several oscillation regimes in which several types of oscillations coexist for different times, frequencies, and amplitudes. It was shown that in each of the oscillation regimes, the ion distribution functions were affected in different ways. We were also able to demonstrate a correlation between the discharge current oscillations and the variation in a capacitive signal collected outside the chamber.

The diagnostic tool of time-frequency analysis by wavelet transform has been imported into the field of the study of propulsion plasma oscillations, and some interesting results have been obtained. The advantage of this technique over analyses based on the Fourier transform is its relative indifference to the fact that our signals are often irregular and that some oscillations are intermittent. We can therefore capture intermittent oscillating structures, such as certain oscillations that only appear at certain precise moments in relation to another oscillation. It has therefore revealed the coexistence and interdependence of several different instabilities: the BM, the ITTO, oscillations at higher frequencies ranging from several hundred kHz to MHz and a RS in the azimuthal direction. We suspect a possible interaction between the breathing mode and the higher-frequency oscillations leading to ITTO. It was observed that a transition between two different oscillations regime seemed to occur when the frequency of one of the BM harmonics became a multiple of the frequency of the higher-frequency oscillations, in parallel with a doubling of the discharge current and a deformation of the IDFs. In all oscillation regimes, when the discharge current varied quickly inside a BM cycle, a pulse is detected on the capacitive signal, reflecting the variation of an electric field in the plasma. These capacitive signal peaks are also correlated with the ITTO oscillations on the discharge current, which they precede. All this information highlights the instability of ITTO. Rapid oscillations were also observed at low discharge voltages, but without any asymmetric change in the IDF, which raises the question of the existence of different ITTO excitation modes. It was also shown that at low discharge voltage, the ITTO centre

frequency was not fixed in time, but shifted towards higher frequencies as the BM advanced (in regime A).

However, we did not identify the mechanism responsible for triggering ITTO. Fluctuations on the cathode potential have been measured in the same frequency ranges, but given that the cathode plasma can exhibit oscillation modes over this same frequency range, it is not currently possible to know whether there is a causal link between these oscillations. We observe that the conditions necessary for rapid oscillations are met when ionisation is at its maximum and no longer evolves with U_d , the azimuthal electron current could also be destabilised by an increasing electron current coming from the cathode and leading to the formation of ITTO. By increasing the discharge voltage (>300 V), the electron current passing through the barrier increases and at the same time we observe a reduction in the rate of presence and amplitude of BM oscillations to the benefit of fast oscillations. In this regime, the average energy of the ions is always close to the energy supplied to the discharge. So, instability combinations may increase the anomalous transport.

It was observed that oscillations at MHz are also much more visible on the ion currents captured by the RPA (without polarisation of the filter grid), than on the other signals. So, they might be oscillations developing in the plasma plume and not in the thruster channel (to be confirmed). Additionally, these oscillations are essentially present when the discharge current is low between two BM cycles or in regimes where the BM is intermittent. The triggering mechanisms are therefore probably different from those responsible for oscillations at lower frequencies.

Questions remain about the mechanisms for stabilising the oscillations corresponding to ITTOs in regime B and about the possible coupling of instabilities on different scales, leading to a doubling of discharge current amplitudes. There are also questions about the origin of the MHz oscillations visible in the ion current collected by the RPA (without ion

filtering) and about their temporal dependence on oscillations with longer periods.

It would also be interesting to determine the temporal evolution of the electron current flowing through the magnetic barrier to determine the impact of low-frequency oscillations on anomalous transport. This work is in progress.

Acknowledgments

Q. D.D. has benefited from a PhD funding from the French Ministry of Research. This work is supported by the CNES agency.

This work has been carried out within the framework of the EUROfusion Consortium, funded by the European Union via the Euratom Research and Training Programme (Grant Agreement No 101052200—EUROfusion). Views and opinions expressed are however those of the author(s) only and do not necessarily reflect those of the European Union or the European Commission. Neither the European Union nor the European Commission can be held responsible for them.

Q. D.D. also likes to thank Mr J. Stevens for his suggestions to improve the quality of the English of this manuscript.

Data Availability

The datasets generated and/or analysed during the current study are available from the corresponding author on reasonable request.

Author Declaration

The authors have no relevant financial or non-financial interests to disclose.

Author Contribution

- All authors contributed to the conception and design of the study.
- Q. Delavrière–Delion and F. Gaboriau took part in the preparation of materials and data collection.
- The data processing was performed by Q. D.D. All authors participated in the analysis of the results.
- The first draft of the manuscript was written by Q. D.D. and all authors provided comments on previous versions of the manuscript. All authors read and approved the final manuscript.

Bibliography

- [1] A. I. Morozov, 'The conceptual development of stationary plasma thrusters', *Plasma Phys. Rep.*, vol. 29, no. 3, pp. 235–250, Mar. 2003, doi: 10.1134/1.1561119.
- [2] D. Lev, R. M. Myers, K. M. Lemmer, J. Kolbeck, H. Koizumi, and K. Polzin, 'The technological and commercial expansion of electric propulsion', *Acta Astronautica*, vol. 159, pp. 213–227, Jun. 2019, doi: 10.1016/j.actaastro.2019.03.058.
- [3] S. Mazouffre, 'Electric propulsion for satellites and spacecraft: established technologies and novel approaches', *Plasma Sources Sci. Technol.*, vol. 25, no. 3, p. 033002, Jun. 2016, doi: 10.1088/0963-0252/25/3/033002.
- [4] D. Krejci and P. Lozano, 'Space Propulsion Technology for Small Spacecraft', *Proc. IEEE*, vol. 106, no. 3, pp. 362–378, Mar. 2018, doi: 10.1109/JPROC.2017.2778747.
- [5] N. Brown and M. L. R. Walker, 'Review of Plasma-Induced Hall Thruster Erosion', *MDPI*, no. 10, p. 3775, May 2020, doi: <https://doi.org/10.3390/app10113775>.
- [6] E. Y. Choueiri, 'Plasma oscillations in Hall thrusters', *Phys. Plasmas*, vol. 8, no. 4, p. 1411, 2001, doi: 10.1063/1.1354644.
- [7] V. Mazières, F. Gaboriau, A. Guglielmi, V. Laquerbe, R. Pascaud, and O. Pascal, 'Broadband (kHz–GHz) characterization of instabilities in Hall thruster inside a metallic vacuum chamber', *Phys. Plasmas*, vol. 29, no. 7, p. 072107, Jul. 2022, doi: 10.1063/5.0090774.
- [8] S. Tsikata, A. Héron, and C. Honoré, 'Hall thruster microturbulence under conditions of modified electron wall emission', *Phys. Plasmas*, vol. 24, no. 5, p. 053519, May 2017, doi: 10.1063/1.4984255.
- [9] Yamamoto, Kuwabara, Cho, Kosuga, and Dif Pradalier, 'Observation of Plasma Turbulence in a Hall Thruster Using Microwave Interferometry', *J. Propul. Power*, 2023, doi: 10.2514/1.B38711.
- [10] A. Guglielmi, 'Propulseur à courant de Hall double étage à source RF inductive: étude expérimentale du fonctionnement et des instabilités basses fréquences', PhD thesis, Paul Sabatier, Toulouse, 2020. [Online]. Available: <https://theses.hal.science/tel-03209825>
- [11] E. Chesta, C. M. Lam, N. B. Meezan, D. P. Schmidt, and M. A. Cappelli, 'A characterization of plasma fluctuations within a Hall discharge', *IEEE Trans. Plasma Sci.*, vol. 29, no. 4, pp. 582–591, Aug. 2001, doi: 10.1109/27.940951.
- [12] J. Kurzyna, S. Mazouffre, A. Lazurenko, L. Albarède, G. Bonhomme, K. Makowski, M. Dudeck, and Z. Peradzynski, 'Spectral analysis of Hall-effect thruster plasma oscillations

This is the author's peer reviewed, accepted manuscript. However, the online version of record will be different from this version once it has been copyedited and typeset.

PLEASE CITE THIS ARTICLE AS DOI: 10.1063/5.0206369

- based on the empirical mode decomposition', *Phys. Plasmas*, vol. 12, no. 12, p. 123506, Dec. 2005, doi: 10.1063/1.2145020.
- [13] L.-Q. Wei, L. Han, D.-R. Yu, and N. Guo, 'Low-frequency oscillations in Hall thrusters', *Chinese Phys. B*, vol. 24, no. 5, p. 055201, May 2015, doi: 10.1088/1674-1056/24/5/055201.
- [14] K. Hara, S. Keller, and Y. Raitses, 'Measurements and theory of driven breathing oscillations in a Hall effect thruster', in *52nd AIAA/SAE/ASEE Joint Propulsion Conference*, Salt Lake City, UT, USA: American Institute of Aeronautics and Astronautics, Jul. 2016. doi: 10.2514/6.2016-4532.
- [15] A. Guglielmi, A. Martin Ortega, F. Gaboriau, and J.-P. Boeuf, 'Influence of double-stage operation on breathing oscillations and rotating spokes in the ID-HALL thruster', in *36th International Electric Propulsion Conference*, Vienne, Autriche, Sep. 2019. [Online]. Available: <https://electricrocket.org/2019/632.pdf>
- [16] A. Martin Ortega, A. Guglielmi, F. Gaboriau, C. Boniface, and J. P. Boeuf, 'Experimental characterization of ID-Hall, a double stage Hall thruster with an inductive ionization stage', *Phys. Plasmas*, vol. 27, no. 2, p. 023518, Feb. 2020, doi: 10.1063/1.5140241.
- [17] V. Giannetti, M. M. Saravia, and T. Andreussi, 'Measurement of the breathing mode oscillations in Hall thruster plasmas with a fast-driving triple Langmuir probe', *Phys. Plasmas*, vol. 27, no. 12, p. 123502, Dec. 2020, doi: 10.1063/5.0022928.
- [18] M. Baird, T. Kerber, R. McGee-Sinclair, and K. Lemmer, 'Plume Divergence and Discharge Oscillations of an Accessible Low-Power Hall Effect Thruster', *Appl. Sci.*, vol. 11, no. 4, p. 1973, Feb. 2021, doi: 10.3390/app11041973.
- [19] M. J. Sekerak, A. D. Gallimore, D. L. Brown, R. R. Hofer, and J. E. Polk, 'Mode Transitions in Hall-Effect Thrusters Induced by Variable Magnetic Field Strength', *J. Propul. Power*, vol. 32, no. 4, pp. 903–917, Jul. 2016, doi: 10.2514/1.B35709.
- [20] N. Gascon, M. Dudeck, and S. Barral, 'Wall material effects in stationary plasma thrusters. I. Parametric studies of an SPT-100', *Phys. Plasmas*, vol. 10, no. 10, pp. 4123–4136, Oct. 2003, doi: 10.1063/1.1611880.
- [21] J. Bareilles, G. J. M. Hagelaar, L. Garrigues, C. Boniface, J. P. Boeuf, and N. Gascon, 'Critical assessment of a two-dimensional hybrid Hall thruster model: Comparisons with experiments', *Phys. Plasmas*, vol. 11, no. 6, pp. 3035–3046, Jun. 2004, doi: 10.1063/1.1719022.
- [22] J. P. Boeuf and L. Garrigues, 'Low frequency oscillations in a stationary plasma thruster', *J. Appl. Phys.*, vol. 84, no. 7, pp. 3541–3554, Oct. 1998, doi: 10.1063/1.368529.
- [23] T. Lafleur, P. Chabert, and A. Bourdon, 'The origin of the breathing mode in Hall thrusters and its stabilization', *J. Appl. Phys.*, vol. 130, no. 5, p. 053305, Aug. 2021, doi: 10.1063/5.0057095.
- [24] O. Chapurin, A. Smolyakov, G. Hagelaar, J.-P. Boeuf, and Y. Raitses, 'Fluid and hybrid simulations of the ionization instabilities in Hall thruster', *J. Appl. Phys.*, vol. 132, no. 5, p. 053301, Aug. 2022, doi: 10.1063/5.0094269.
- [25] J. Vaudolon and S. Mazouffre, 'Observation of high-frequency ion instabilities in a cross-field plasma', *Plasma Sources Sci. Technol.*, vol. 24, no. 3, p. 032003, Jun. 2015, doi: 10.1088/0963-0252/24/3/032003.
- [26] J. Vaudolon, 'Electric field determination and magnetic topology optimization in Hall thruster', PhD thesis, ICARE - Institut de Combustion, Aérodynamique, Réactivité et Environnement, Orléans, 2015. [Online]. Available: <https://theses.hal.science/tel-01320637/>
- [27] G. J. M. Hagelaar, J. Bareilles, L. Garrigues, and J.-P. Boeuf, 'Two-dimensional model of a stationary plasma thruster', *J. Appl. Phys.*, vol. 91, no. 9, pp. 5592–5598, Apr. 2002, doi: 10.1063/1.1465125.
- [28] F. Petronio, 'Plasma instabilities in Hall Thrusters: a theoretical and numerical study', PhD thesis, École Polytechnique, Palaiseau, 2023. [Online]. Available: <https://theses.hal.science/tel-04401336>
- [29] Esipchuk, A. I. Morozov, Tilinin, and Trofimov, 'Plasma oscillations in closed-drift accelerator with an extended acceleration zone', *Sov. Phys. Tech. Phys.*, vol. 18, no. 7, pp. 928–932, Jul. 1973.
- [30] S. Tsikata, 'Small-scale electron density fluctuations in the Hall thruster, investigated by collective light scattering', PhD thesis, École Polytechnique, Palaiseau, 2009. [Online]. Available: <https://pastel.hal.science/tel-00484027/document>
- [31] T. Dubois, L. Garrigues, S. Tsikata, and M. Chung To Sang, 'Insights into Hall thruster radial physics via incoherent Thomson scattering', in *37th International Electric Propulsion Conference Massachusetts Institute of Technology*, Boston, MA, USA, Jun. 2022. [Online]. Available: <https://www.jotform.com/uploads/electricrocket/220994246997171/5327477536329503338/Insights%20into%20Hall%20thruster%20radial%20physics%20via%20incoherent%20Thomson%20scattering%20%28%20IEPC-2022-331%29%20%283%29.pdf>
- [32] G. S. Janes and R. S. Lowder, 'Anomalous Electron Diffusion and Ion Acceleration in a Low-Density Plasma', *Phys. Fluids*, vol. 9, no. 6, pp. 1115–1123, Jun. 1966, doi: 10.1063/1.1761810.
- [33] M. S. McDonald and A. D. Gallimore, 'Rotating Spoke Instabilities in Hall Thrusters', *IEEE Trans. Plasma Sci.*, vol. 39, no. 11, pp. 2952–2953, Nov. 2011, doi: 10.1109/TPS.2011.2161343.
- [34] C. L. Ellison, Y. Raitses, and N. J. Fisch, 'Cross-field electron transport induced by a rotating spoke in a cylindrical Hall thruster', *Phys. Plasmas*, vol. 19, no. 1, p. 013503, Jan. 2012, doi: 10.1063/1.3671920.
- [35] S. Mazouffre, L. Grimaud, S. Tsikata, K. Matyash, and R. Schneider, 'Rotating spoke instabilities in a wall-less Hall thruster: experiments', *Plasma Sources Sci. Technol.*, vol. 28, no. 5, p. 054002, May 2019, doi: 10.1088/1361-6595/ab07fc.
- [36] A. Guglielmi, F. Gaboriau, and J. P. Boeuf, 'Simultaneous measurements of axial motion and azimuthal rotation of non-uniformities ("spokes") in a Hall thruster', *Phys. Plasmas*, vol. 29, no. 11, p. 112108, Nov. 2022, doi: 10.1063/5.0111975.
- [37] J. M. Sequeira Mealha Beck Senart, 'Experimental Characterization of the Double Stage Hall Thruster ID-Hall by Retarding Potential Analyzer', Laplace, Toulouse, Master thesis, May 2019. [Online]. Available: <https://fenix.tecnico.ulisboa.pt/cursos/mef/dissertacao/565303595502653>
- [38] A. Smirnov, Y. Raitses, and N. J. Fisch, 'Experimental and theoretical studies of cylindrical Hall thrusters', *Phys. Plasmas*, vol. 14, no. 5, p. 057106, May 2007, doi: 10.1063/1.2718522.
- [39] Y. Raitses, A. Smirnov, and N. J. Fisch, 'Enhanced performance of cylindrical Hall thrusters', *Appl. Phys. Lett.*, vol. 90, no. 221502, May 2007, doi: <https://doi.org/10.1063/1.2741413>.
- [40] A. Loyal, F. Darnon, L. Albarede, V. Lago, P. Lasgorceix, and M. Dudeck, 'Correlation Between Hollow Cathode Operating Conditions and Hall Thruster (SPT100-ML) Performance Characteristics', in *38th AIAA/ASME/SAE/ASEE Joint Propulsion Conference & Exhibit*, Indianapolis, Indiana: American Institute of Aeronautics and Astronautics, Jul. 2002. doi: 10.2514/6.2002-4101.
- [41] H. Valentin and M. Stéphane, 'Optimization of a Faraday Cup Collimator for Electric Propulsion Device Beam Study: Case of a Hall Thruster', *Applied Sciences*, vol. 11, no. 5, Art. no. 5, Jan. 2021, doi: 10.3390/app11052419.
- [42] C. Philippe Kadlec, 'Caractérisations spatio-temporelles de jets ioniques : développement des diagnostics et application à la propulsion ionique', PhD thesis, GREMI, Orléans, 1998. Accessed: Mar. 19, 2023. [Online]. Available: <https://www.theses.fr/1998ORLE2063>
- [43] H. Andrei, V. Covlea, V. V. Covlea, and E. Barna, 'The smoothing and the digital processing of Langmuir probe characteristic', *Romanian J. Phys.*, vol. 55, no. 2, pp. 51–56, 2003.
- [44] A. Caldarelli, F. Filleul, R. W. Boswell, C. Charles, N. J. Rattenbury, and J. E. Cater, 'Data processing techniques for ion and electron-energy distribution functions', *Phys. Plasmas*, vol. 30, no. 4, p. 040501, Apr. 2023, doi: 10.1063/5.0133840.
- [45] J. Vaudolon, D. Harribey, C. Henaux, S. Mazouffre, and A. Rossi, 'Influence de la topologie magnétique et des conditions expérimentales sur les performances du propulseur PPS-FLEX', CNRS, CNES, Safran, ICARE, Orléans, Unpublished report RAPPORT PE-R-02-2014, 2014.

This is the author's peer reviewed, accepted manuscript. However, the online version of record will be different from this version once it has been copyedited and typeset.

PLEASE CITE THIS ARTICLE AS DOI: 10.1063/5.0206369

- [46] B. K. Parida, K. P. Sooraj, S. Hans, V. Pachchigar, S. Augustine, T. Remyamol, M. R. Ajith, and M. Ranjan, 'Sputtering yield and nanopattern formation study of BNSiO₂ (Borosil) at elevated temperature relevance to Hall Effect Thruster', *Nuclear Inst. and Methods in Physics Research, B*, vol. 514, pp. 1–7, Mar. 2022, doi: 10.1016/j.nimb.2022.01.001.
- [47] B. Ph. Van Milligen, C. Hidalgo, and E. Sánchez, 'Nonlinear Phenomena and Intermittency in Plasma Turbulence', *Phys. Rev. Lett.*, vol. 74, no. 3, pp. 395–398, Jan. 1995, doi: 10.1103/PhysRevLett.74.395.
- [48] M. McDonald, R. Liang, and A. D. Gallimore, 'Practical Application of Wide Bandwidth Floating Emissive Probes and Wavelet Analysis to the X2 Nested Hall Thruster', in *33rd International Electric Propulsion Conference*, Washington D.C., USA, Oct. 2013. [Online]. Available: <https://electricrocket.org/IEPC/Iwc9kt4f.pdf>
- [49] G. Bonhomme, N. Lemoine, F. Brochard, A. Lazurenko, S. Mazouffre, and M. Dudeck, 'Characterization of High Frequency plasma oscillations in a Hall Effect Thruster', in *30th International Electric Propulsion Conference*, Florence, Italia, Sep. 2007. Accessed: Nov. 14, 2023. [Online]. Available: <https://electricrocket.org/IEPC/IEPC-2007-247.pdf>
- [50] M. S. McDonald, M. J. Sekerak, A. D. Gallimore, and R. R. Hofer, 'Plasma oscillation effects on nested Hall thruster operation and stability', in *2013 IEEE Aerospace Conference*, Big Sky, MT: IEEE, Mar. 2013, pp. 1–12. doi: 10.1109/AERO.2013.6497190.
- [51] C. Torrence and G. P. Compo, 'A Practical Guide to Wavelet Analysis', *Bull. Amer. Meteor. Soc.*, vol. 79, no. 1, pp. 61–78, Jan. 1998, doi: 10.1175/1520-0477(1998)079<0061:APGTWA>2.0.CO;2.
- [52] M. Farge, K. Schneider, and P. Devynck, 'Analyse en ondelettes de signaux de plasmas de bord, et extraction des événements cohérents', CEA, Contrat CEA/EURATOM Rapport final, 1ère année, 2001. [Online]. Available: <http://wavelets.ens.fr/PUBLICATIONS/ARTICLES/PDF/156.pdf>
- [53] Y. Meyer, S. Jaffard, and O. Rioul, 'L'analyse par ondelettes', *Pour la Science*, pp. 28–37, Sep. 1987.
- [54] J.-Y. Richard, 'Présentation de la méthode des Ondelettes', Observatoire de Paris, Sep. 04, 2006. [Online]. Available: https://www5.obs-mip.fr/wp-content-omp/uploads/sites/28/2017/11/Ondelettes_GRS_2006.pdf
- [55] A. Bultheel, 'Learning to swim in a sea of wavelets', *Bull. Belg. Math. Soc. Simon Stevin*, vol. 2, no. 1, pp. 1–46, Jan. 1995, doi: 10.36045/bbms/1103408773.
- [56] M. Farge, *Wavelet transforms and their applications to turbulence*, Annu. Rev. Fluid Mech. 1992. [Online]. Available: <https://api.semanticscholar.org/CorpusID:238437106>
- [57] D. B. Percival and A. T. Walden, *Wavelet Methods for Time Series Analysis*. in Cambridge Series in Statistical and Probabilistic Mathematics. Cambridge: Cambridge University Press, 2000. doi: 10.1017/CBO9780511841040.
- [58] F. Malgouyres, 'Analyse par Ondelettes'. Master 2 IMAT Mathematical Engineering course in Toulouse (in French). [Online]. Available: <http://www.math.univ-toulouse.fr/~fmalgouy/enseignement/ondelettes.html>
- [59] N. Kuwabara, M. Chono, T. Morita, and N. Yamamoto, 'Anomalous Electron Transport in Hall Thrusters: Electric Field Fluctuation Measurement', *Aerospace Technology Japan*, vol. 19, no. 1, pp. 81–86, 2021, doi: 10.2322/tastj.19.81.